

METAL CONSTRUCTION 31

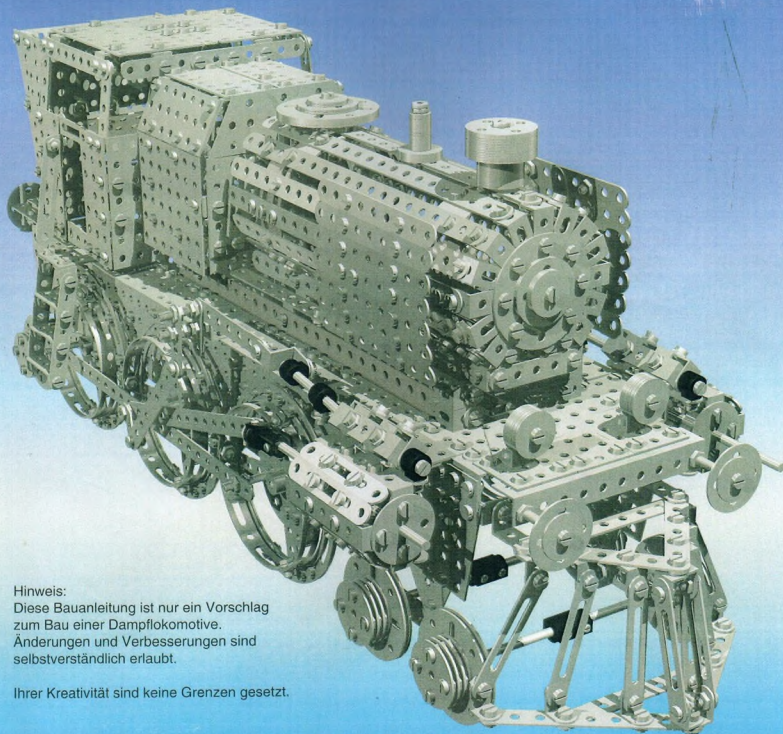

Hinweis:
Diese Bauanleitung ist nur ein Vorschlag
zum Bau einer Dampflokomotive.
Änderungen und Verbesserungen sind
selbstverständlich erlaubt.

Ihrer Kreativität sind keine Grenzen gesetzt.

eitech
MADE IN GERMANY

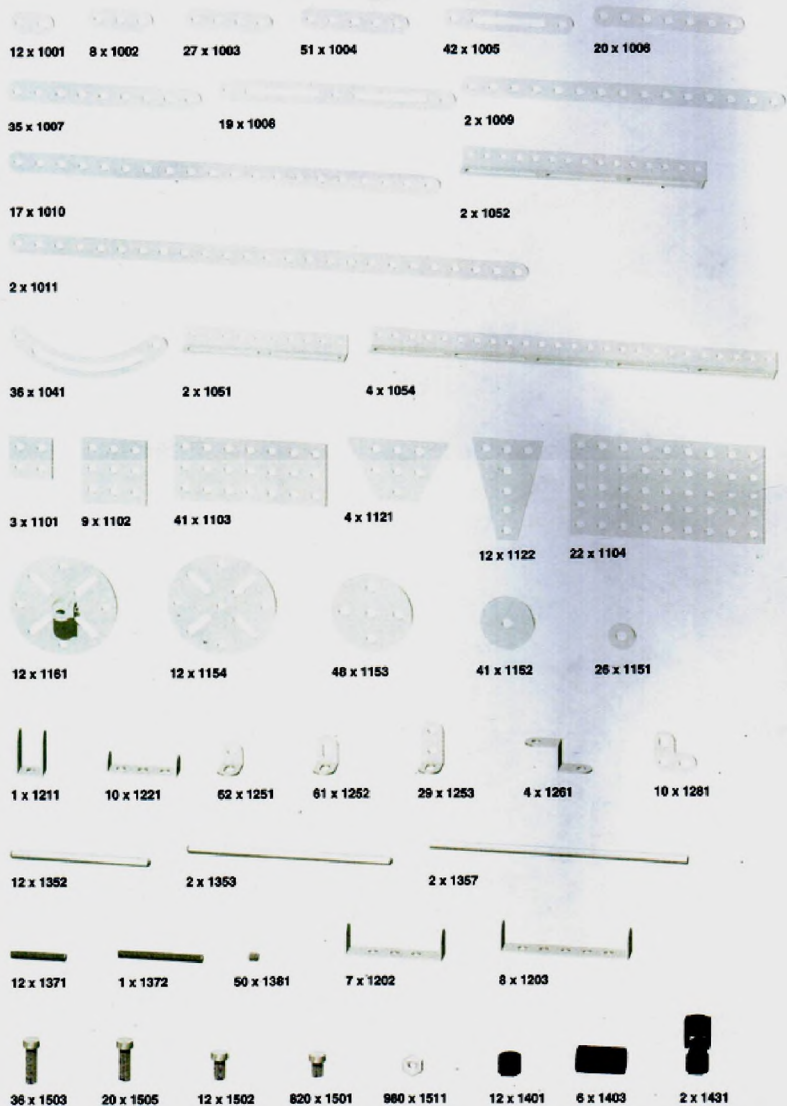

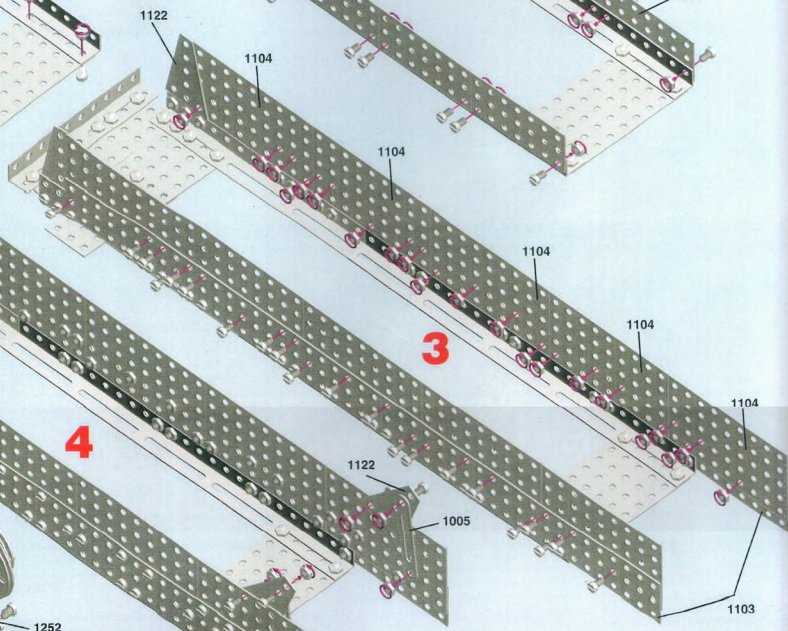
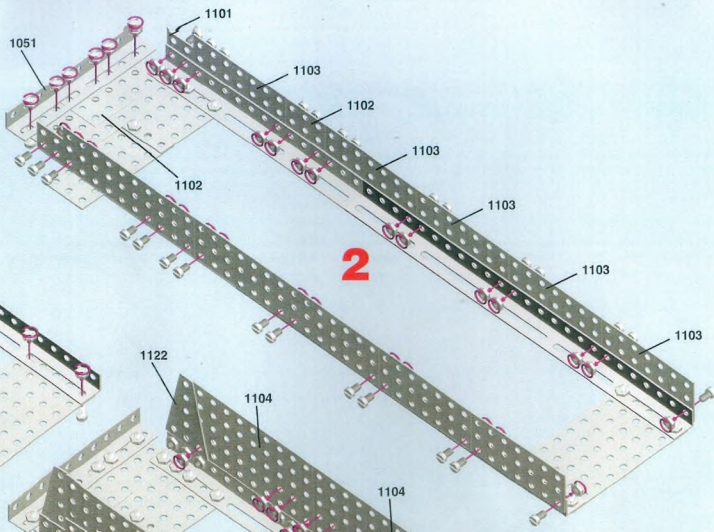
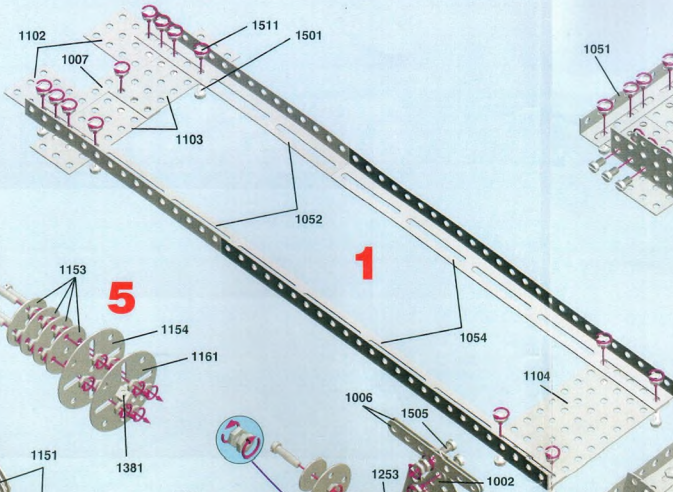
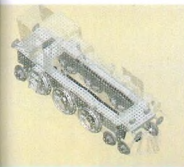

6 (6x)

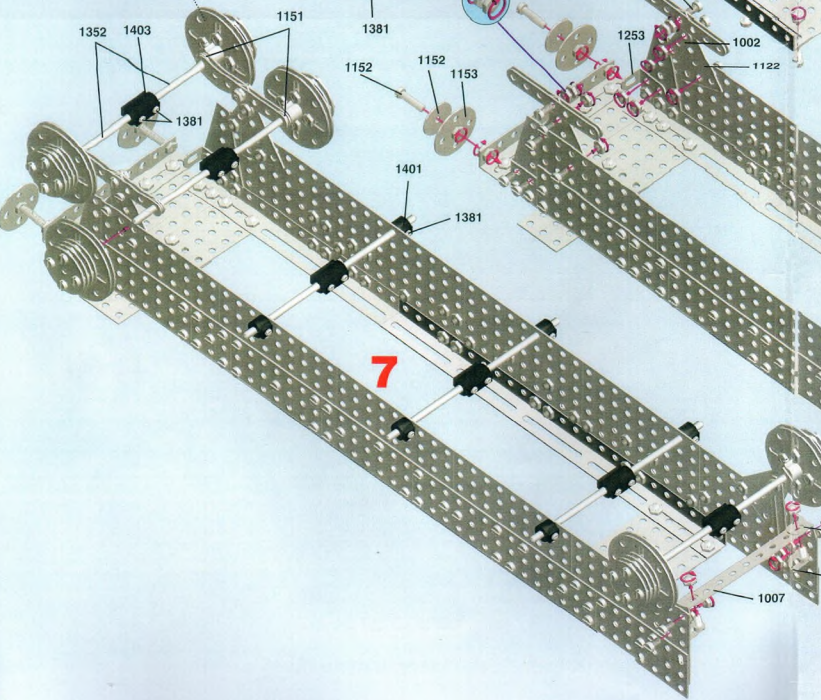
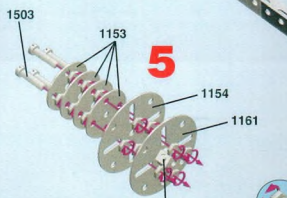

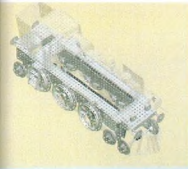

8 (18x)

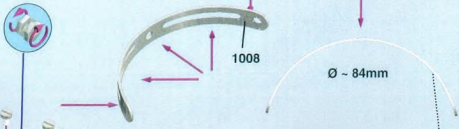

9

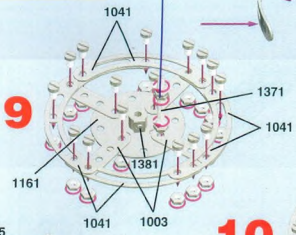

10

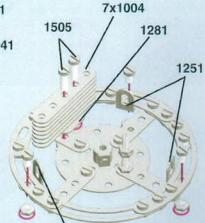

11 (6x)



12

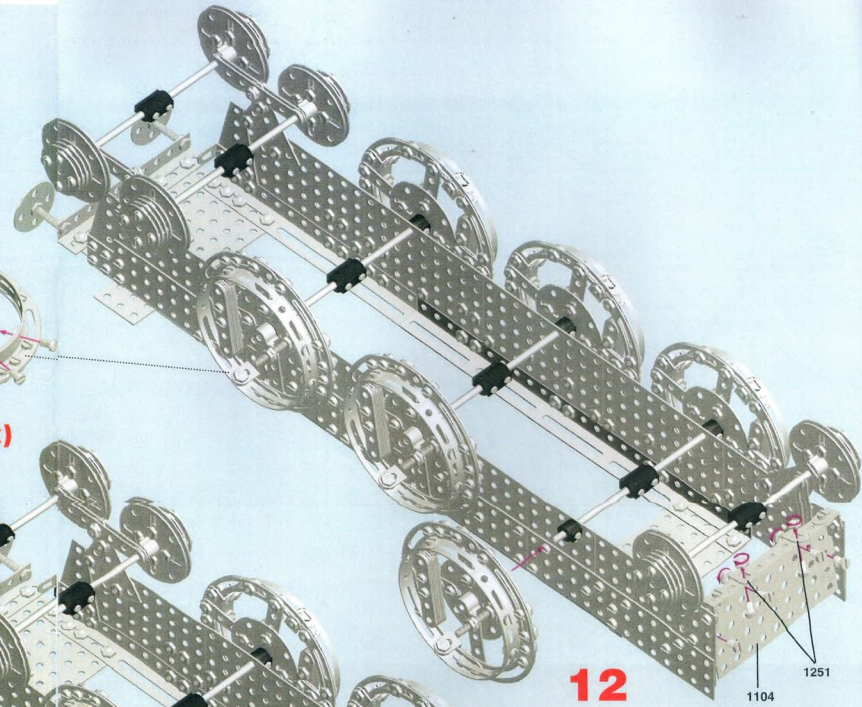

14

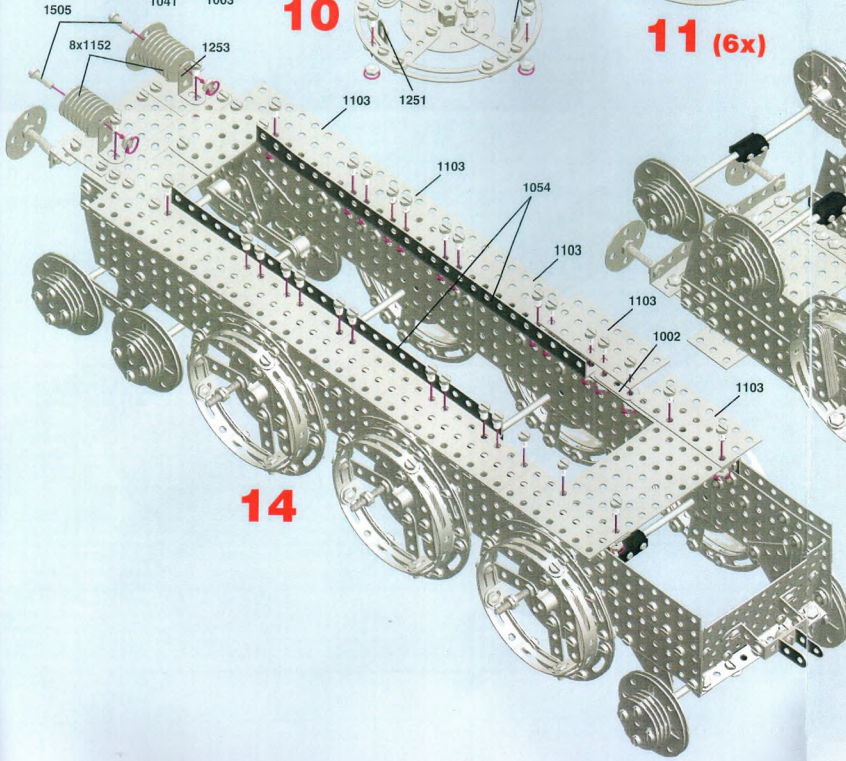

13

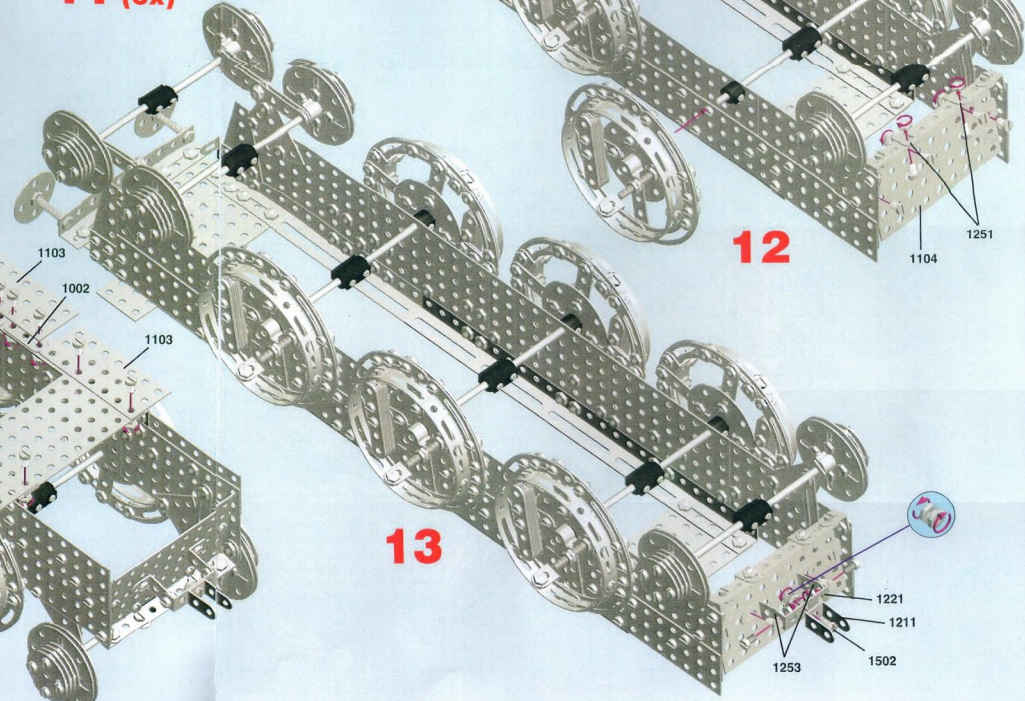

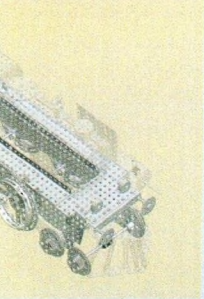

8 (18x)

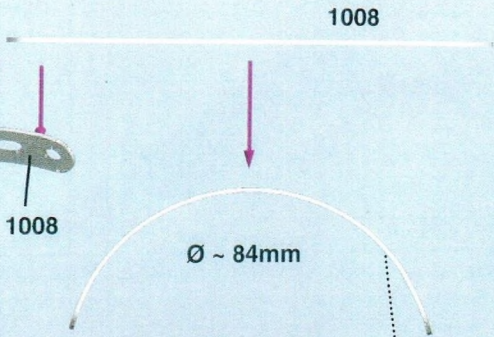

9

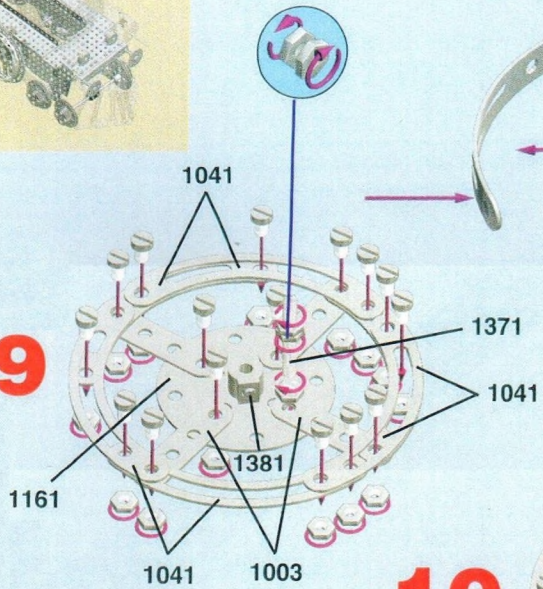

10

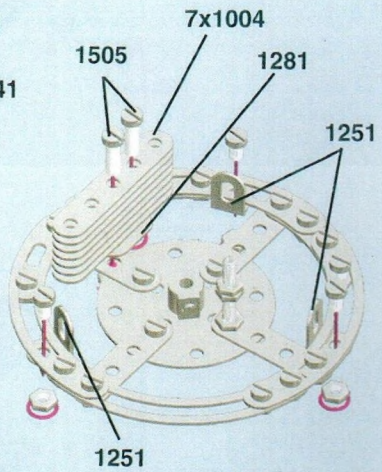

11 (6x)

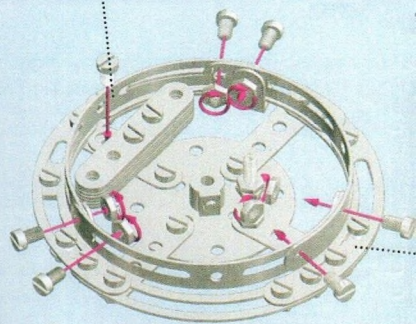

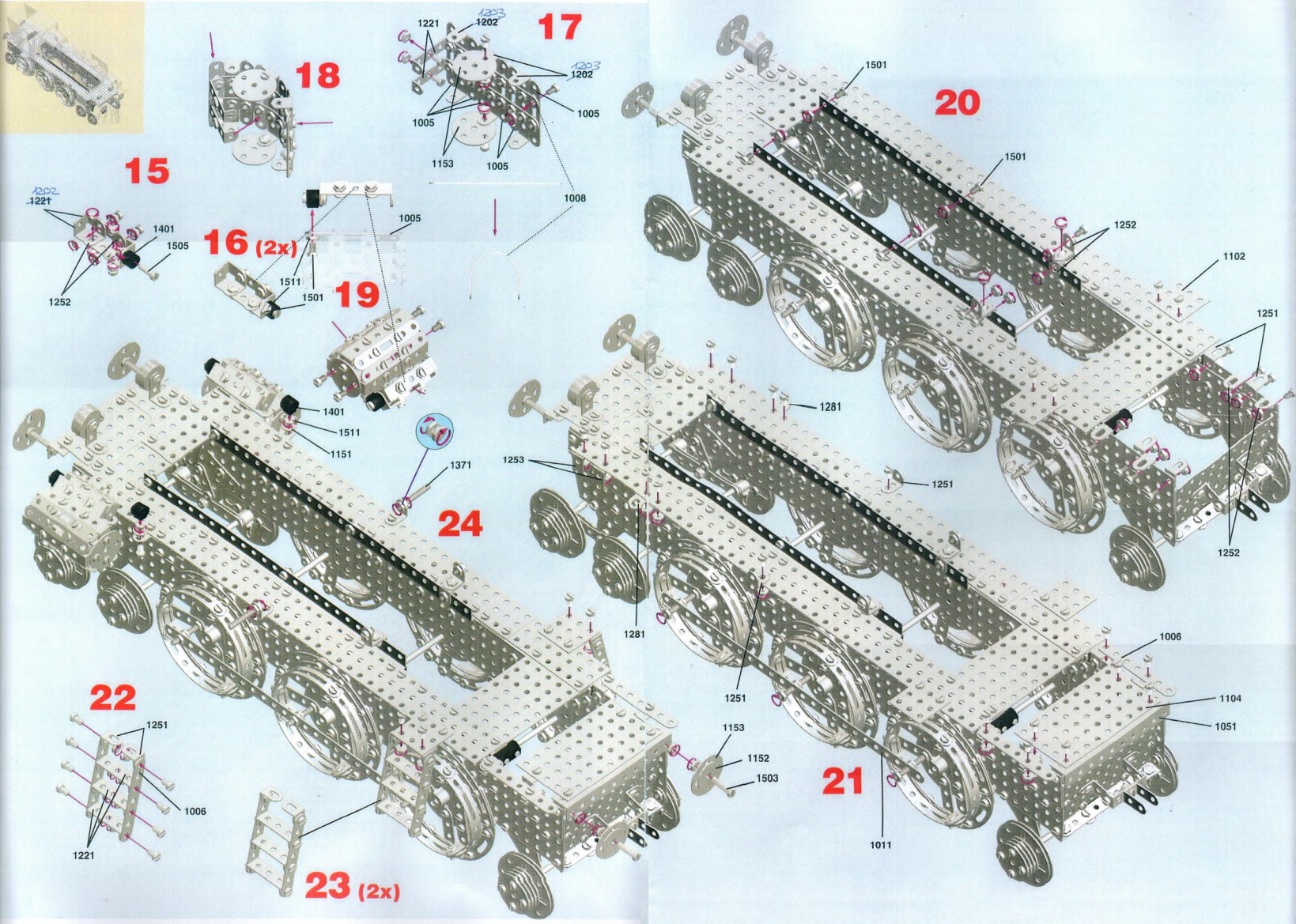

17

18

15

16 (2x)

19

20

24

22

23 (2x)

21

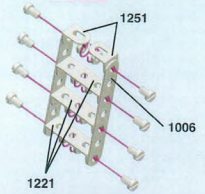
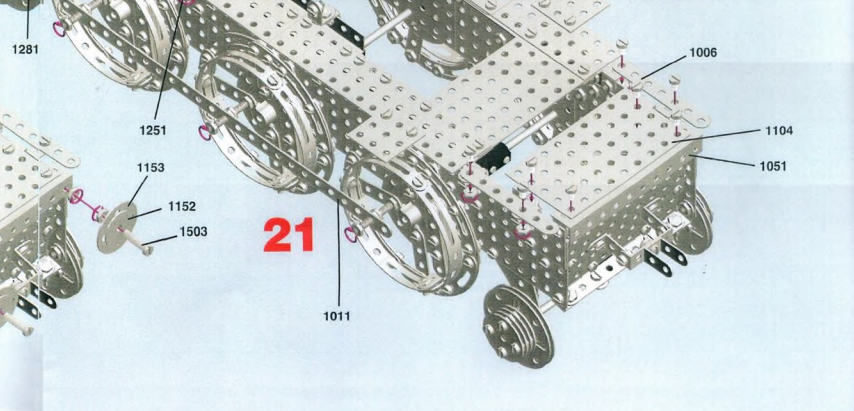
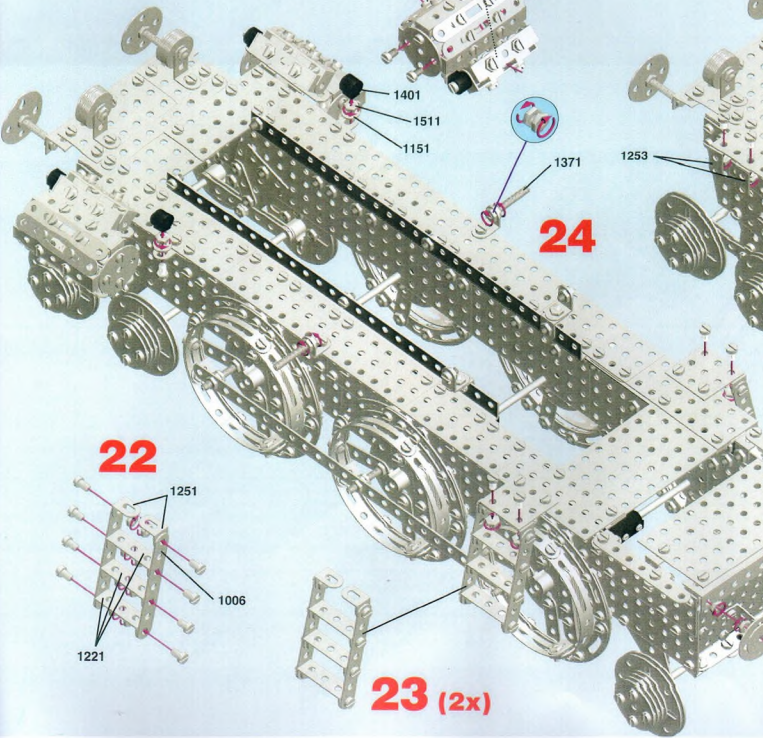
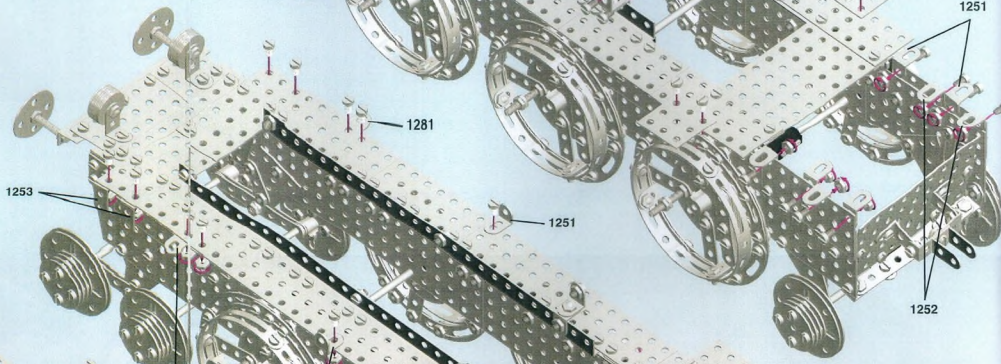
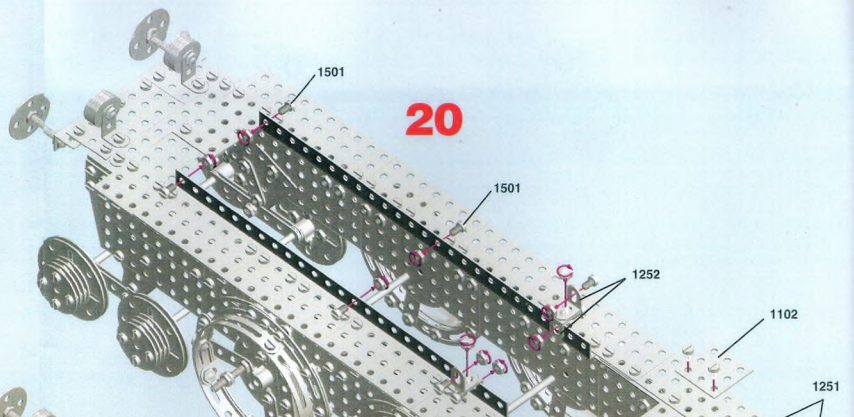
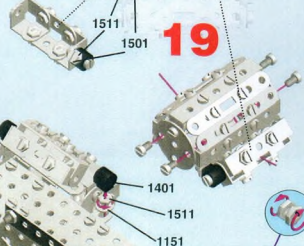
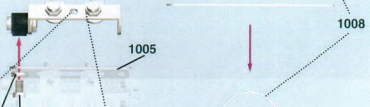
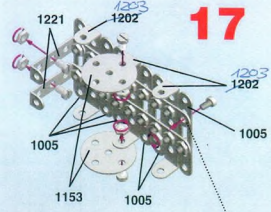
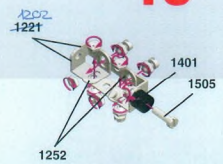

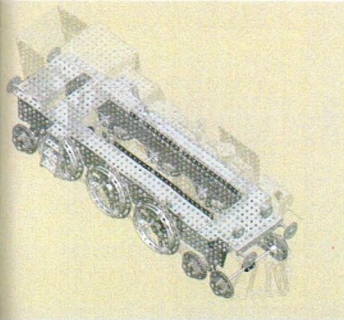

15

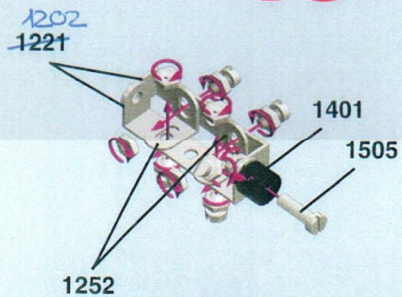

18

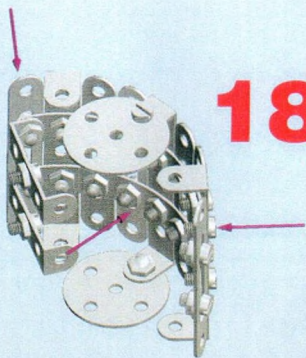

17

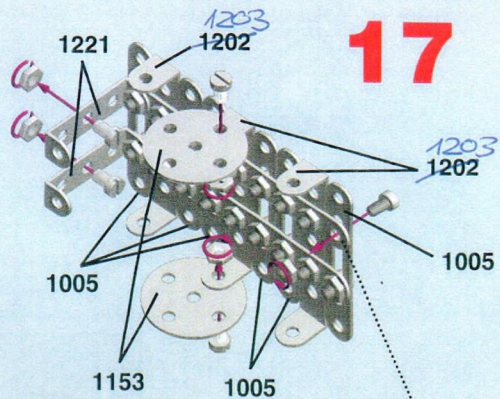

16 (2x)

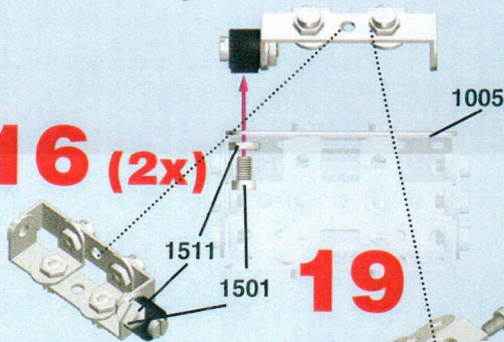

19

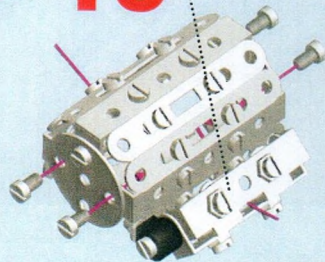

1008

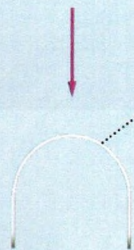

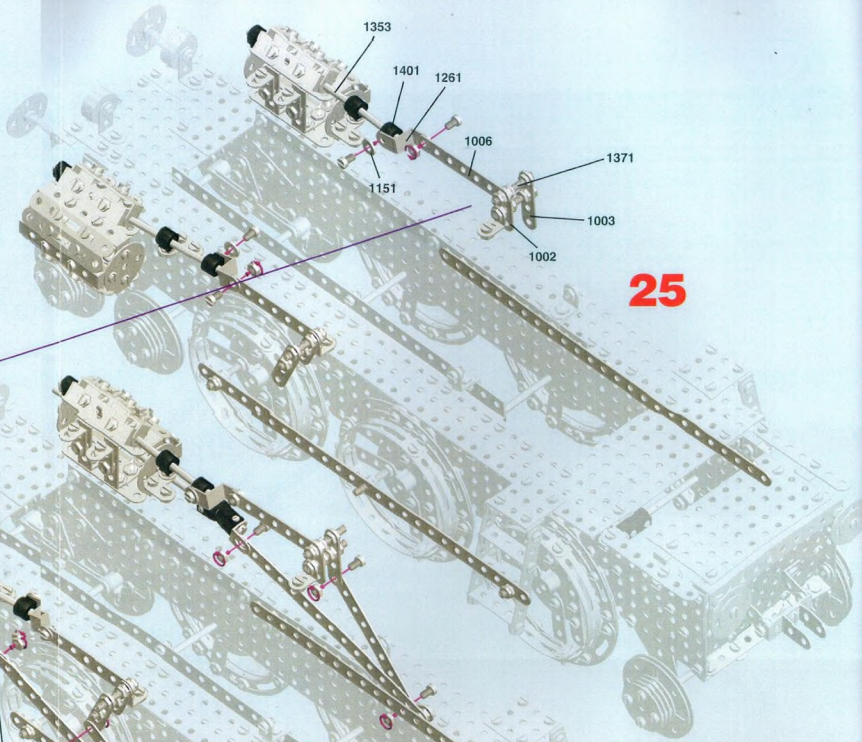
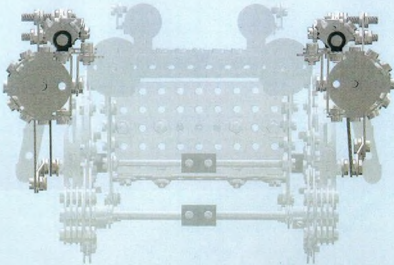

25

1353
1401
1261
1006
1151

1371
1003
1002

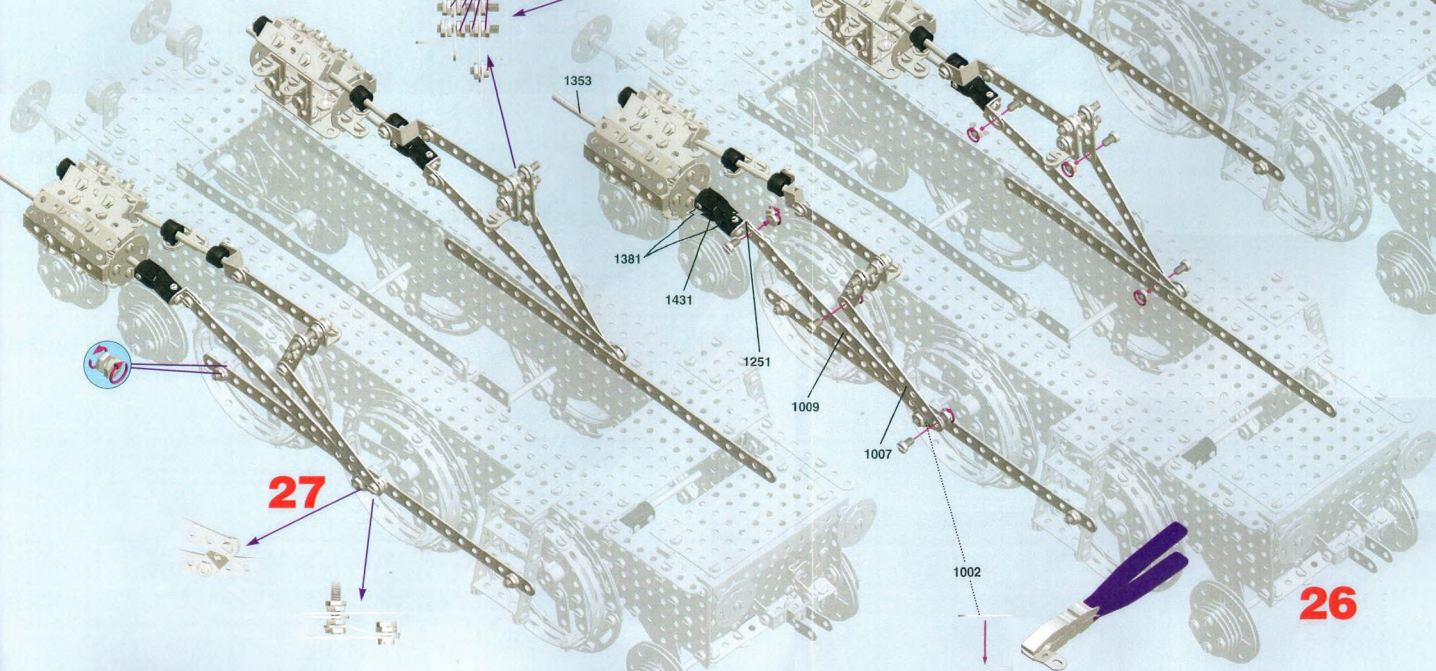
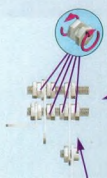

27

1353

1381
1431

1251

1009

1007



1002

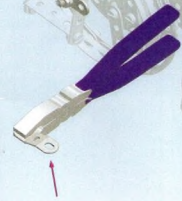

26

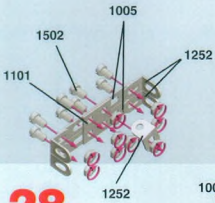
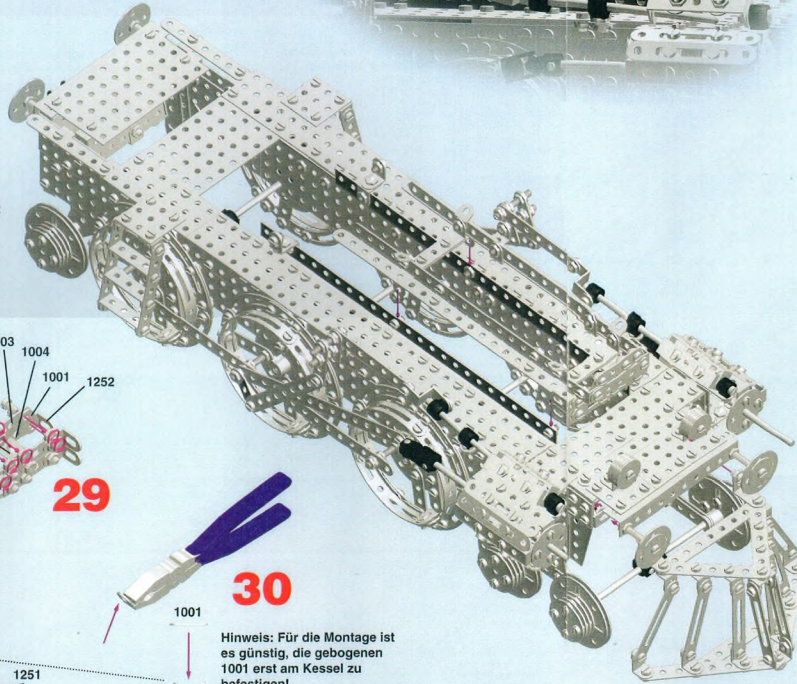
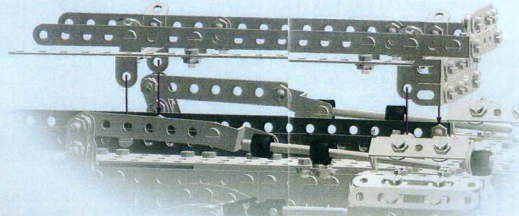

28

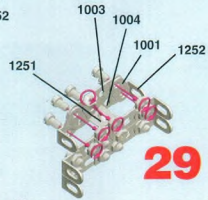

29

Hinweis: Schraube 1501 erst nach Montage des Kessels festziehen (Bild 55)!

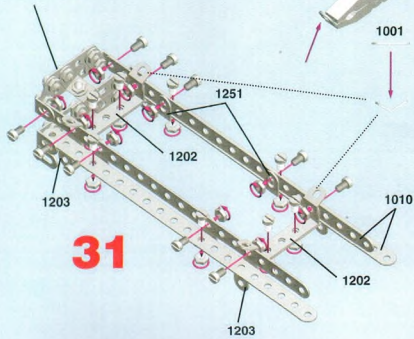

31



30

Hinweis: Für die Montage ist es günstig, die gebogenen 1001 erst am Kessel zu befestigen!

32

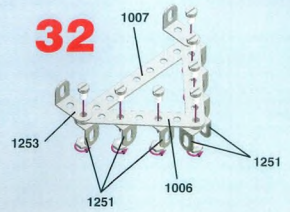

33

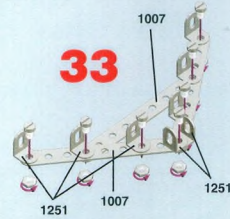

34

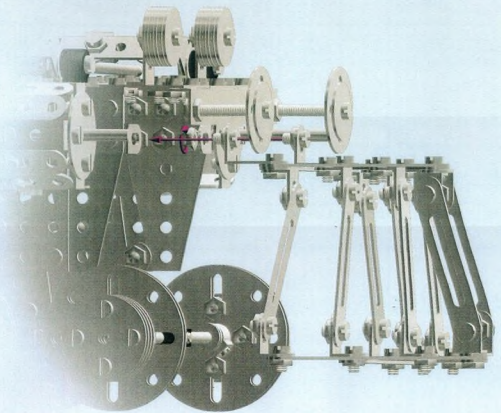
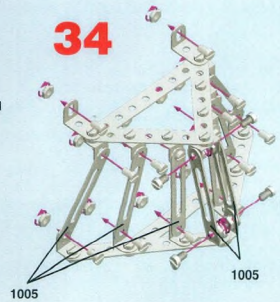

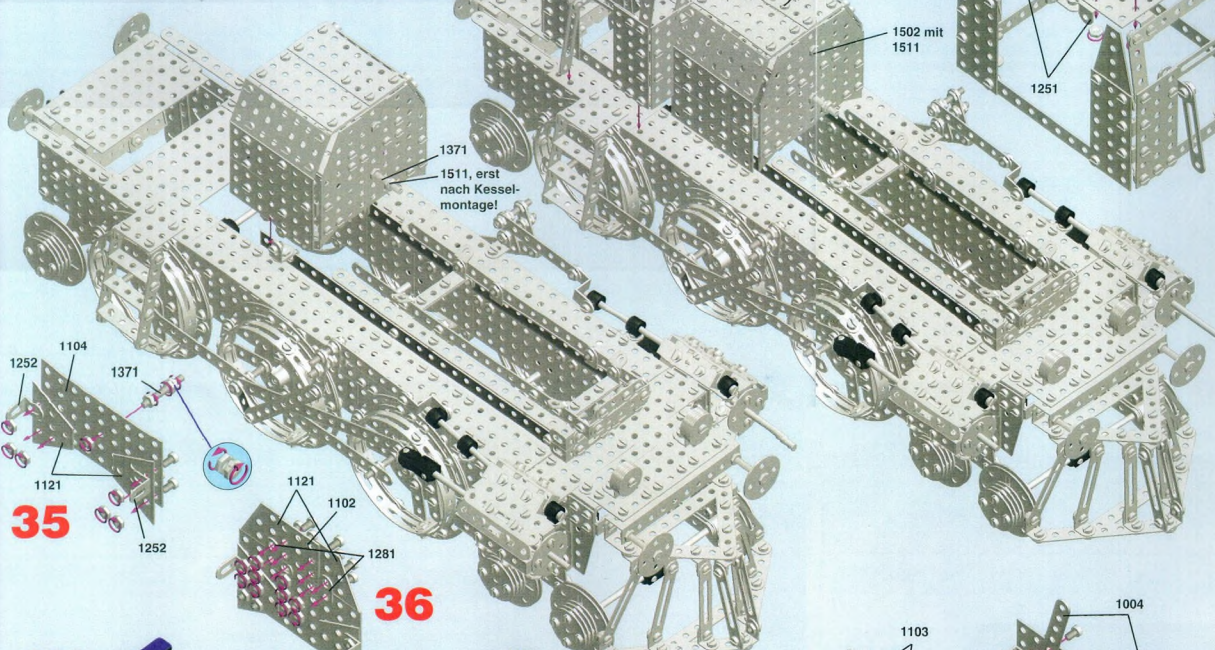
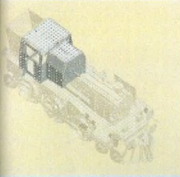

45

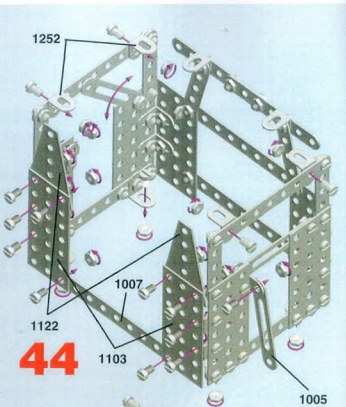
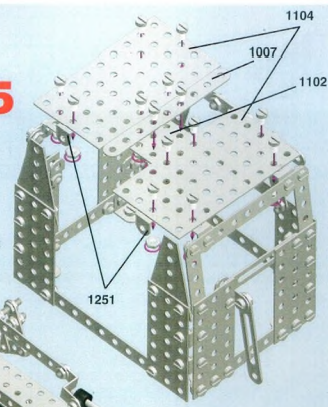

44

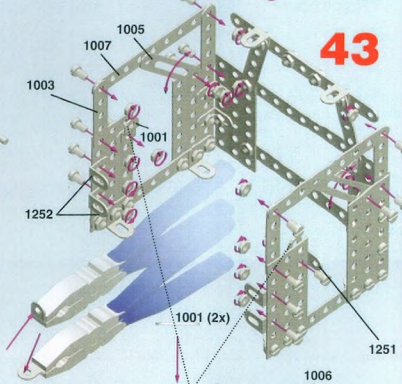

43

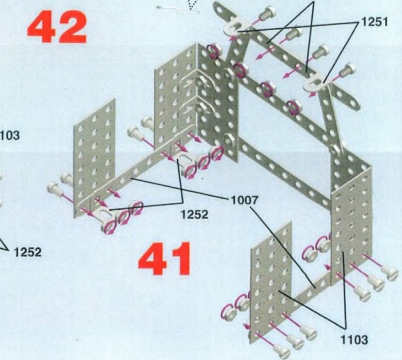

42

35

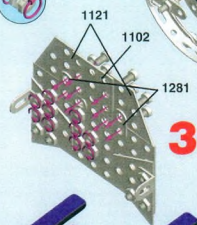
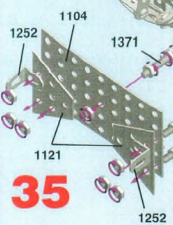

36



37

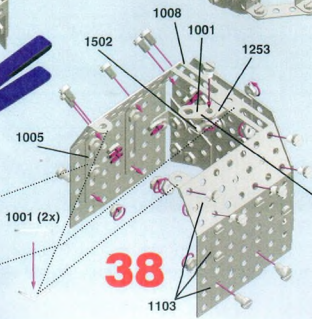

38

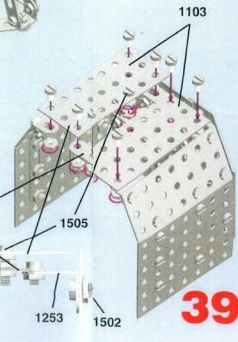

39

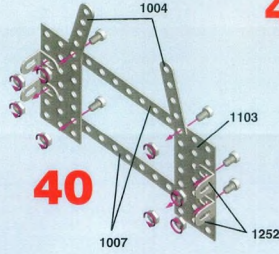

40

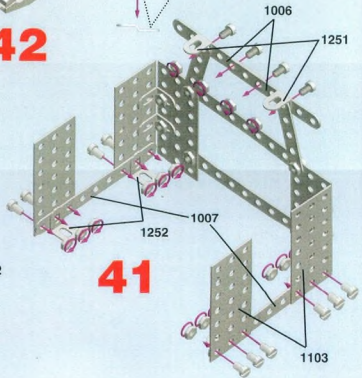

41

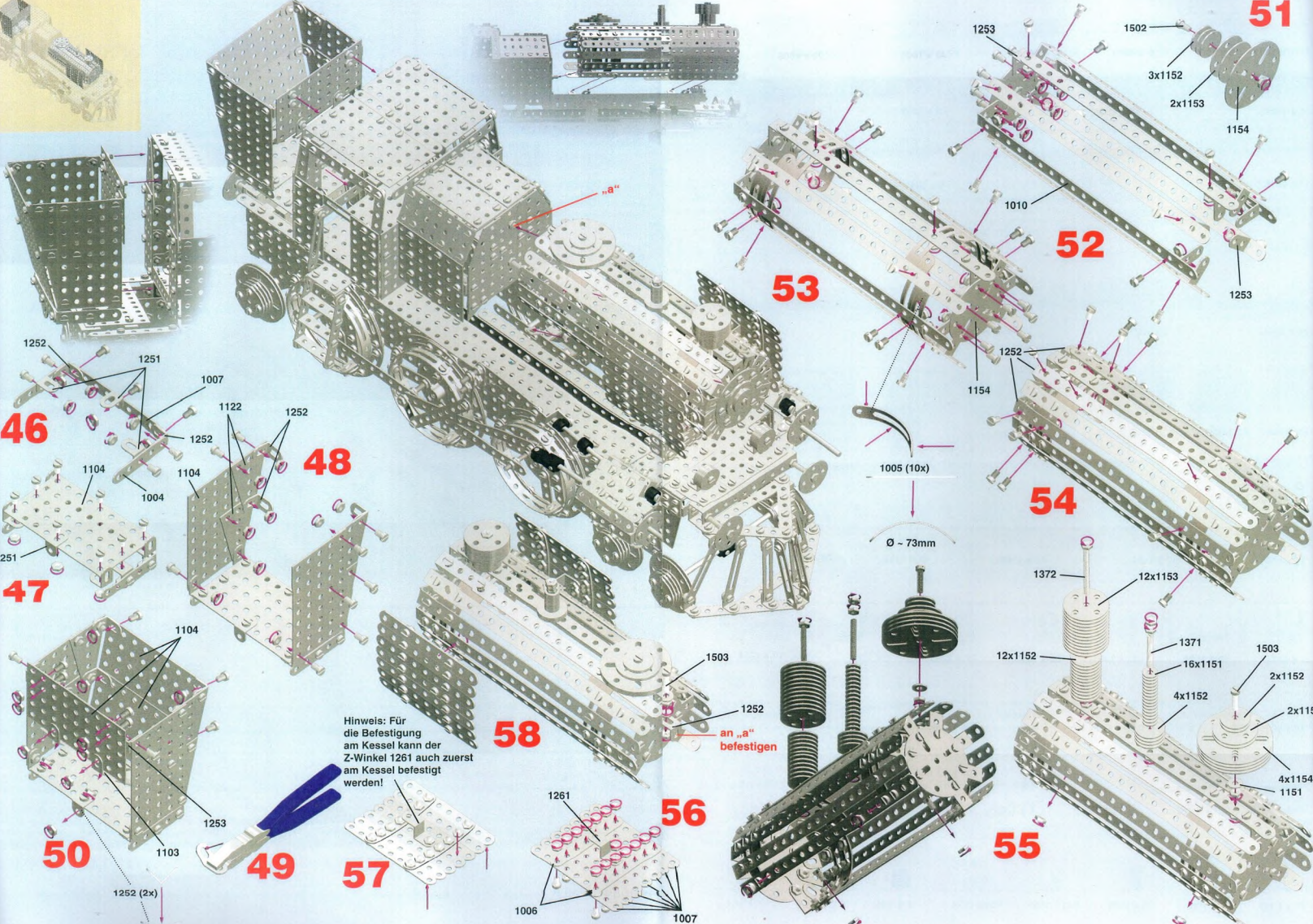

46

47

50

48

49

57

58

56

53

52

54

55

Hinweis: Für die Befestigung am Kessel kann der Z-Winkel 1261 auch zuerst am Kessel befestigt werden!

„a“

an „a“ befestigen

Ø ~ 73mm

1005 (10x)

1502
3x1152
2x1153
1154

1253

1010

1253

1252

1154

1252

1251

1007

1122

1252

1104

1104

1004

1251

1104

1253

1103

1252 (2x)

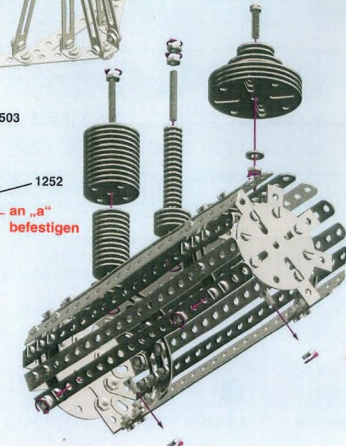

1372

12x1153

12x1152

1371

16x1151

1503

2x1152

2x1152

4x1154

1151

1261

1006

1007

1503

1252