

CONSTRUCTION

Bauanleitung

15

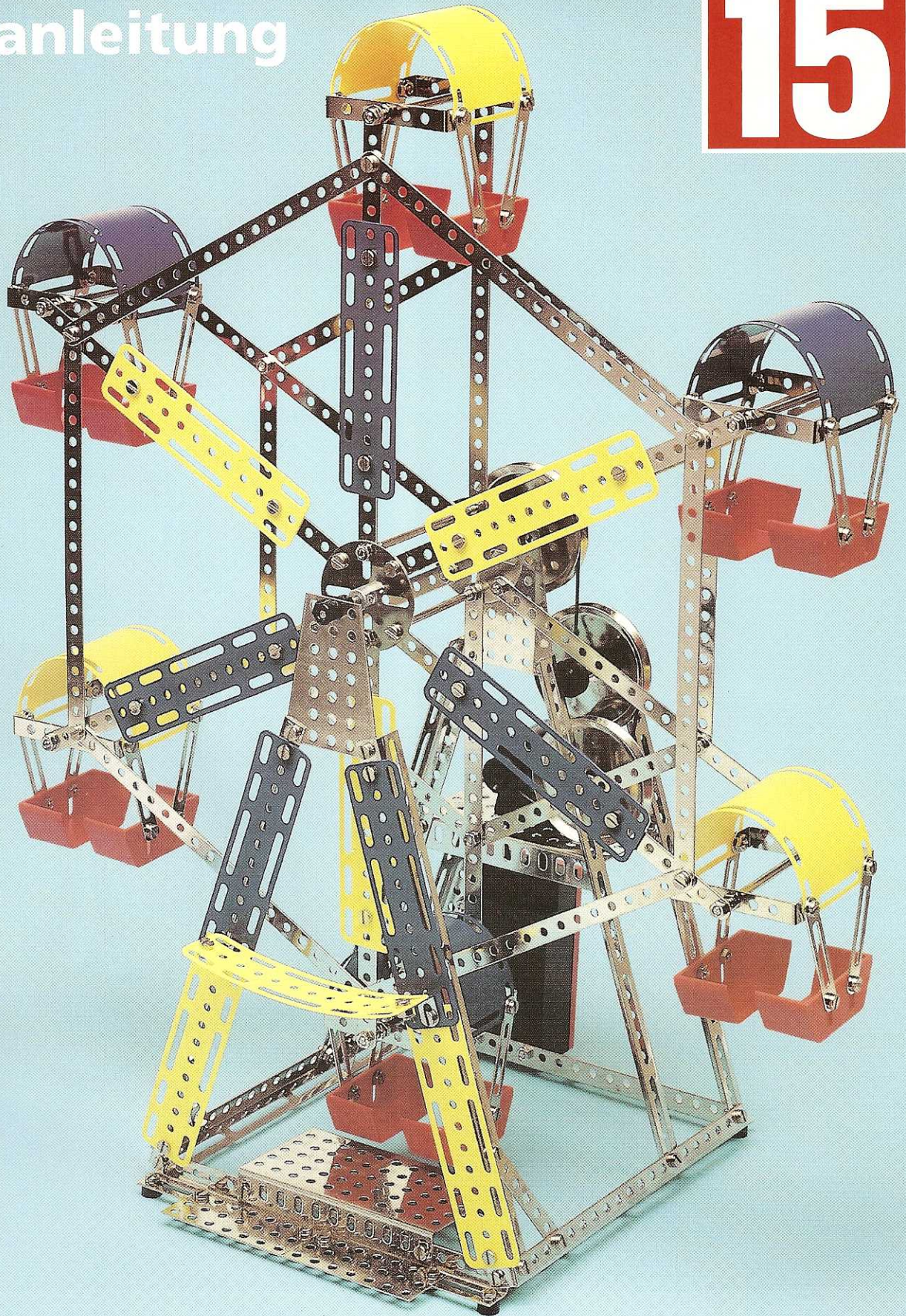

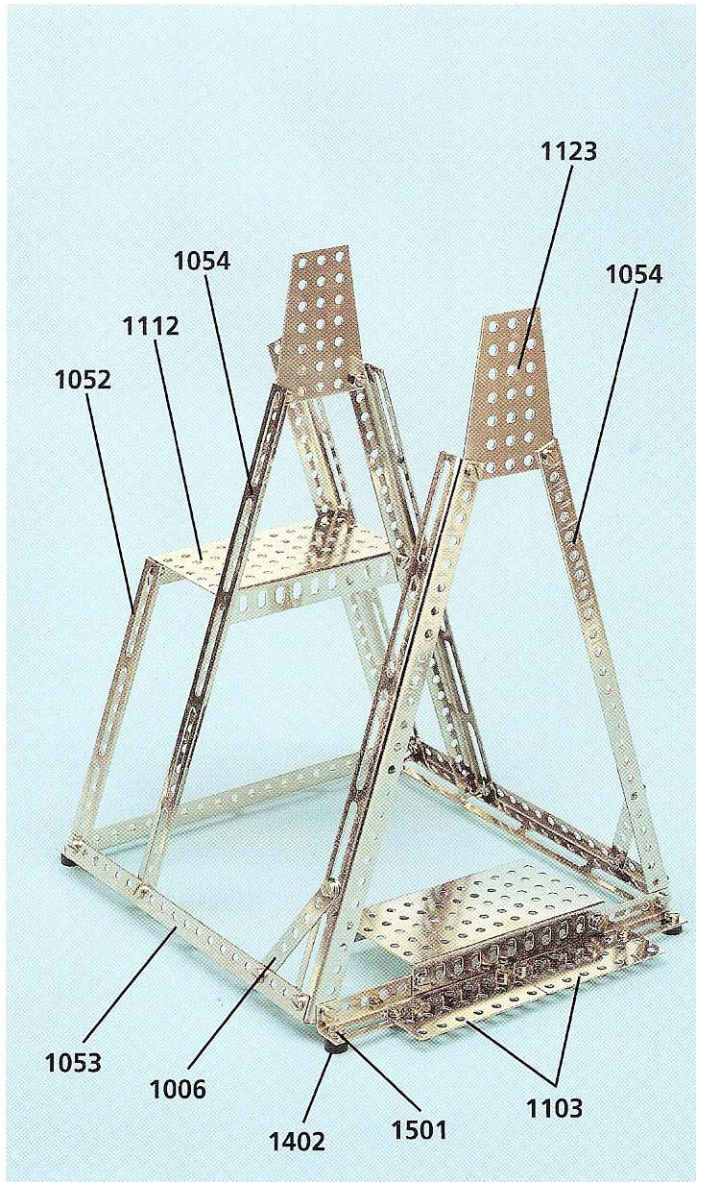
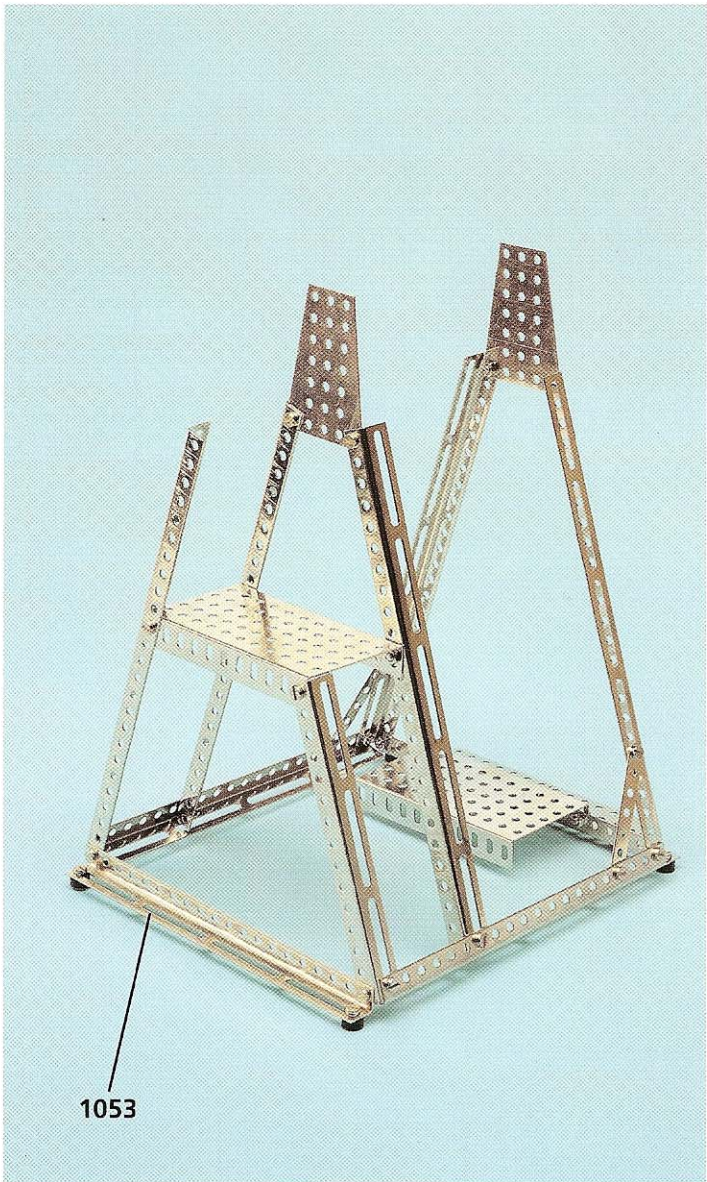
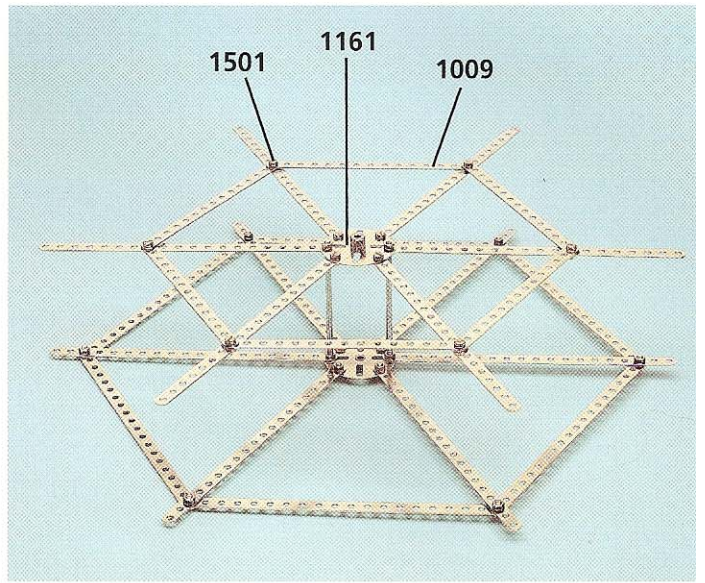
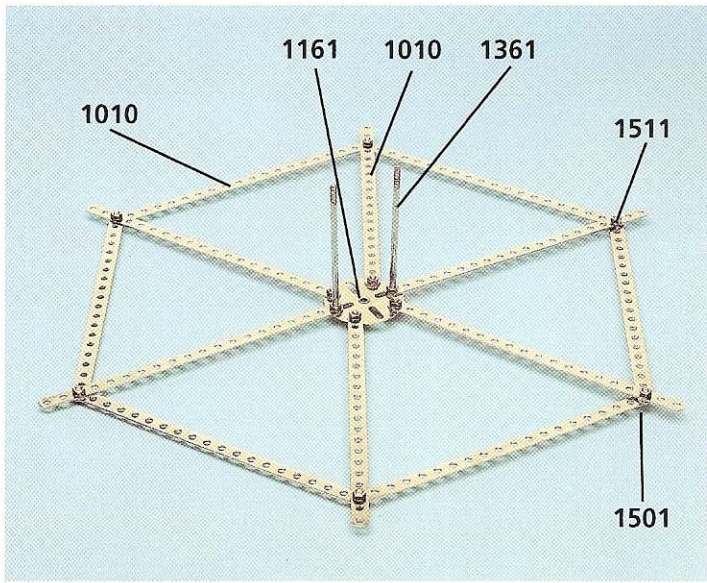

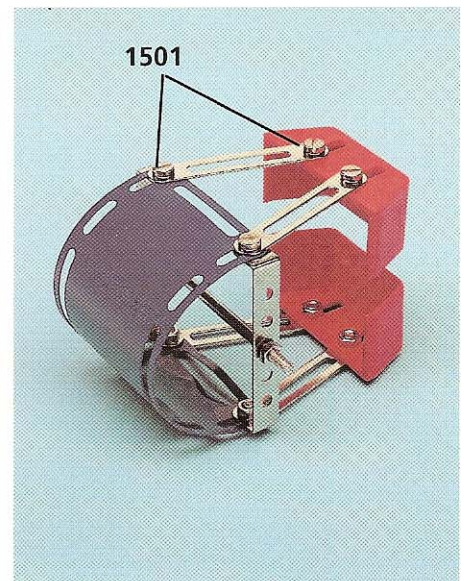
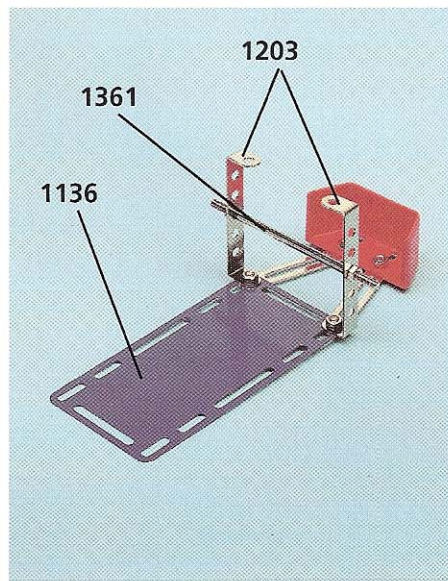
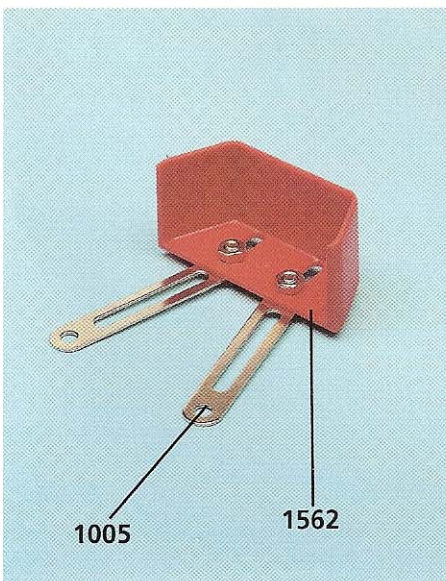
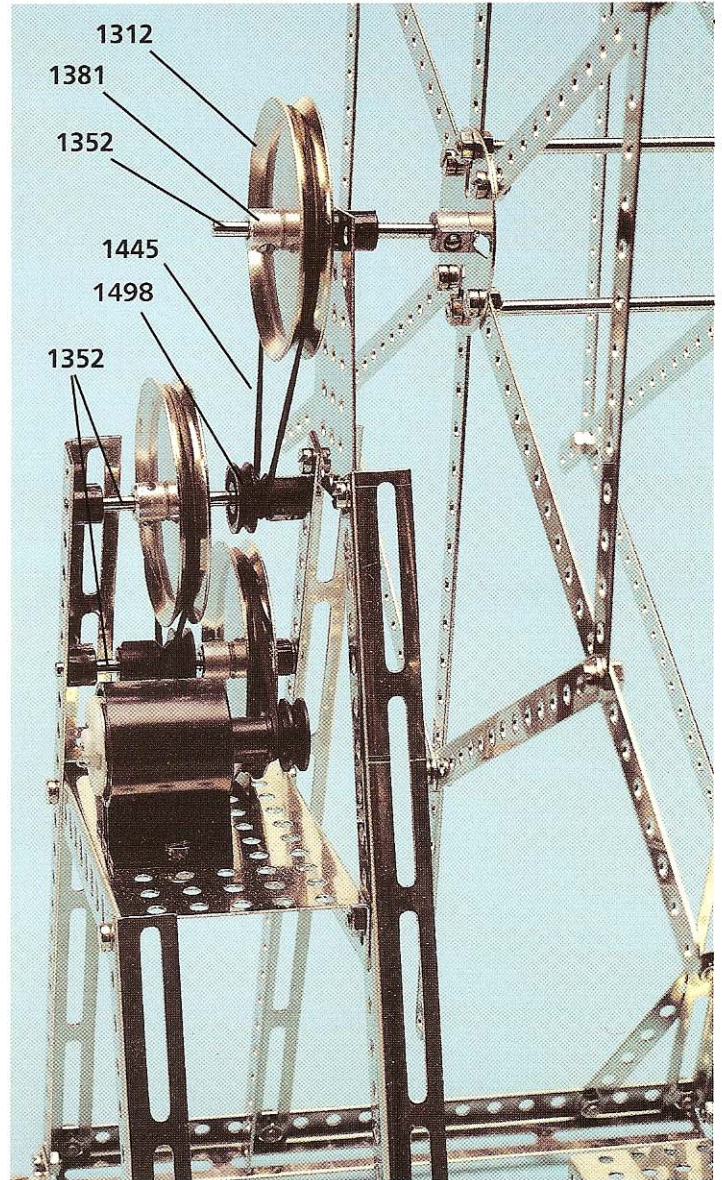
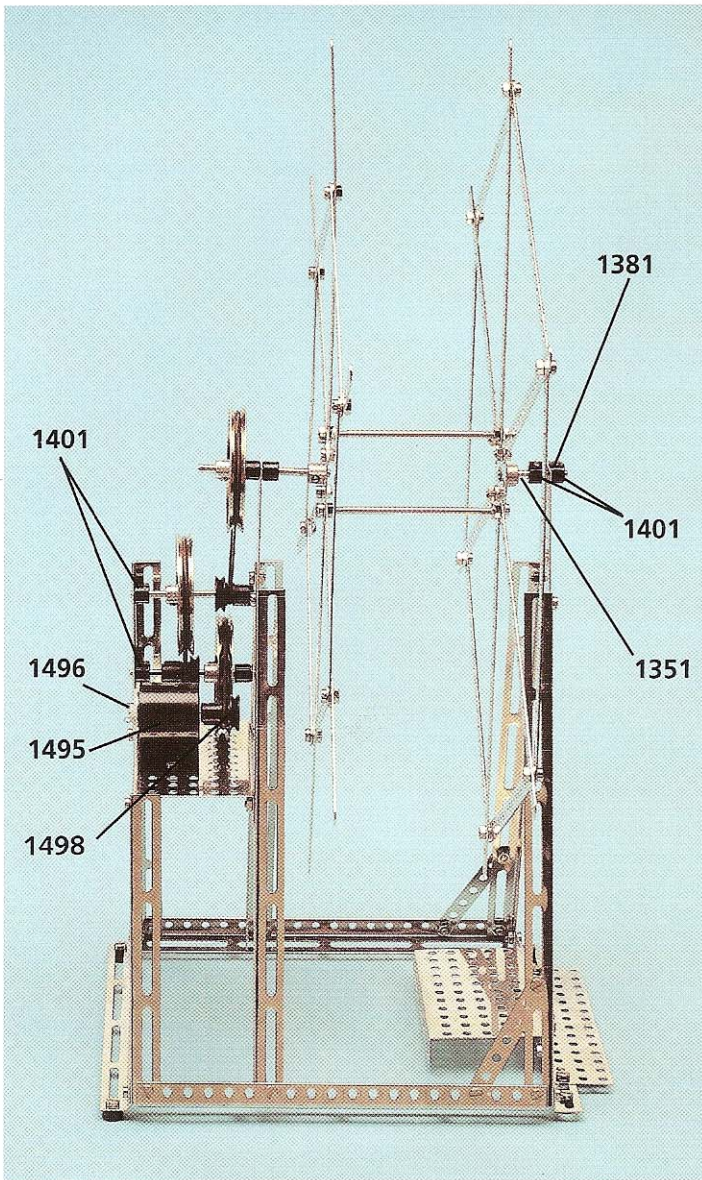

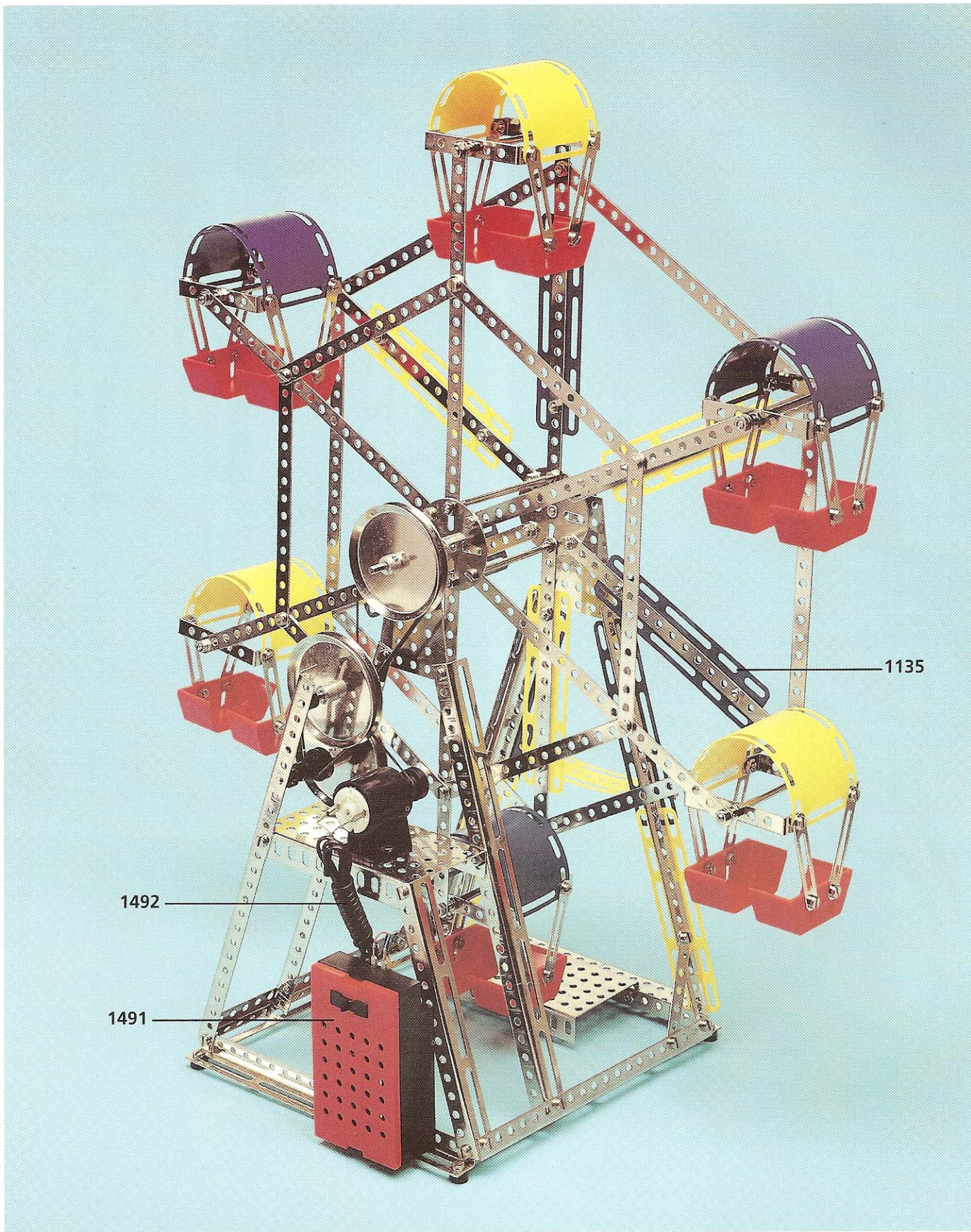

1492

1491

1135

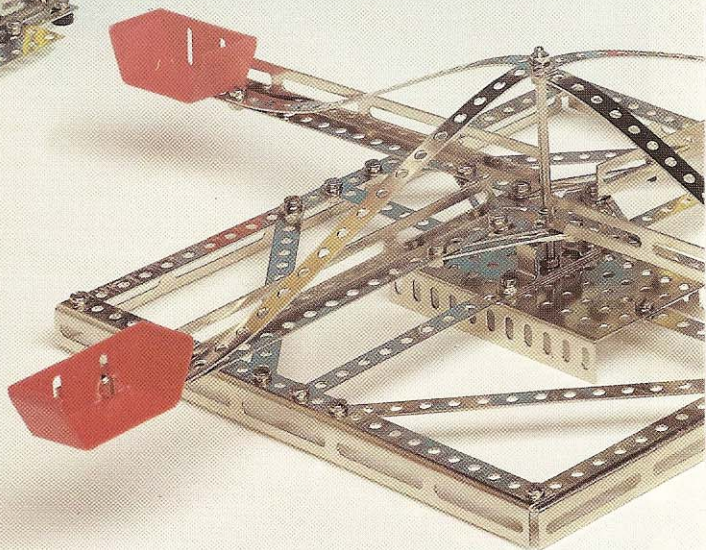



METAL CONSTRUCTION **15**

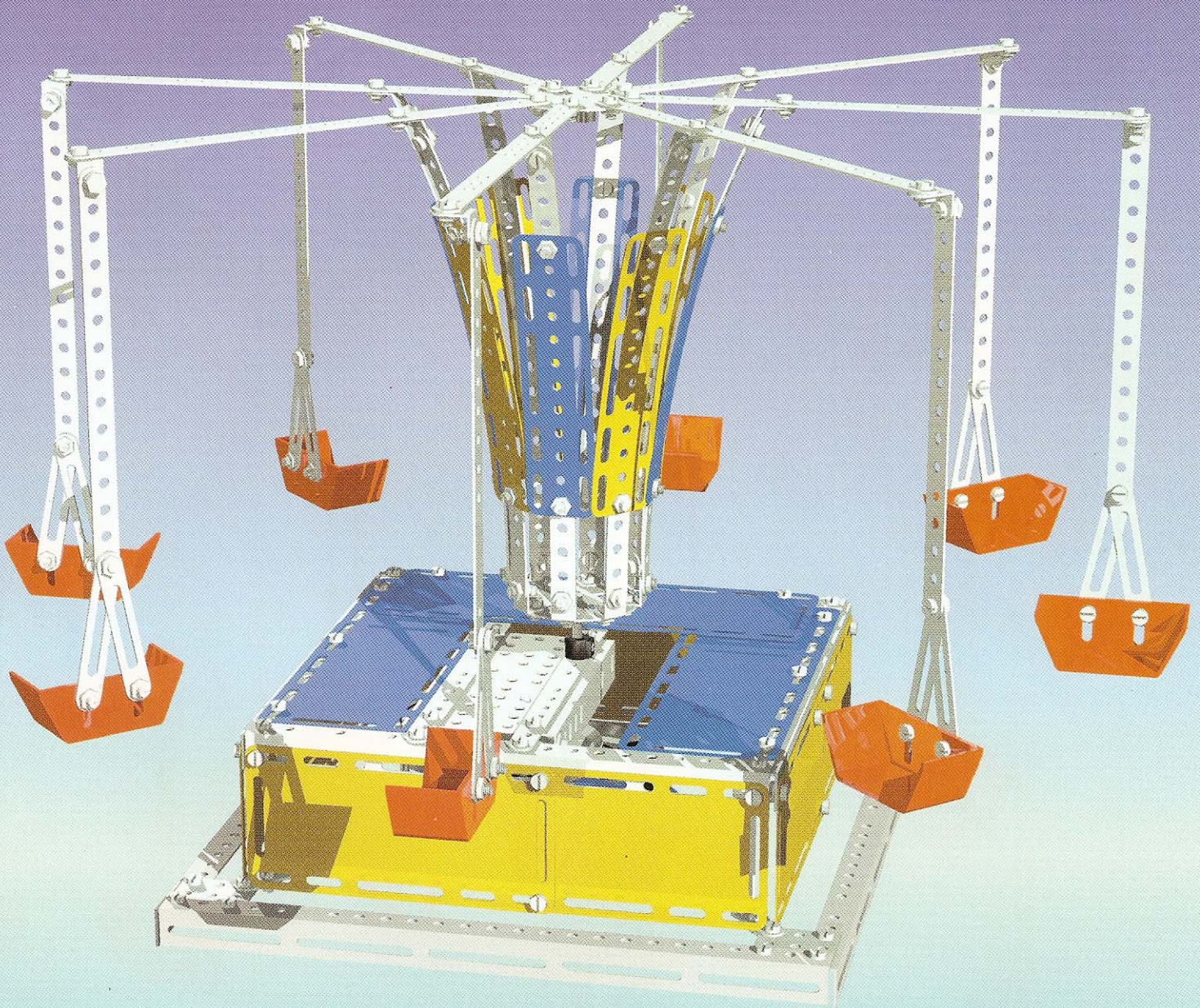

BAUTEILE JEWEILS NUR FÜR EIN
MODELL VERFÜGBAR

HILFE VON ERWACHSENEN KANN
ERFORDERLICH SEIN

eitech

MADE IN GERMANY

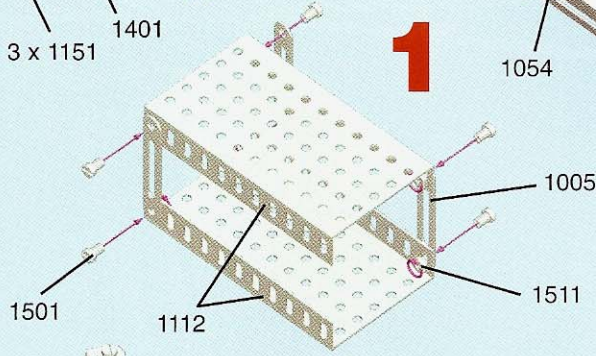
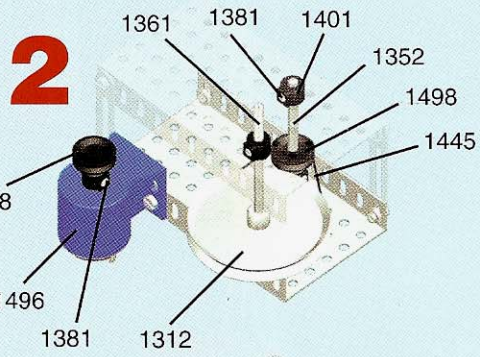
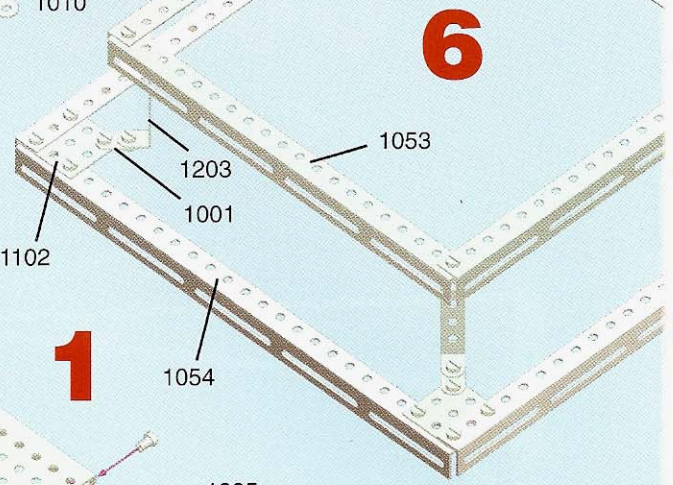
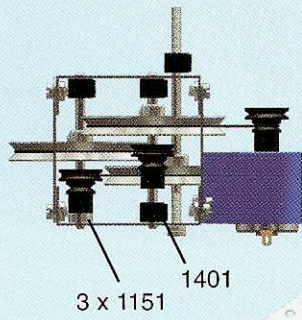
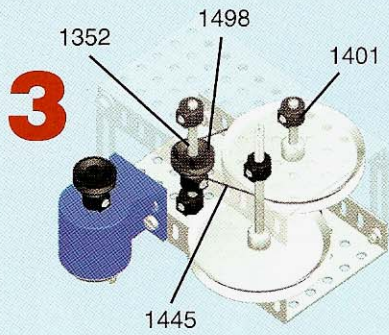
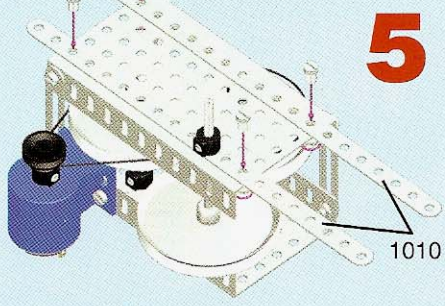
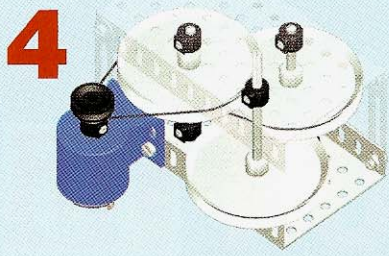

8

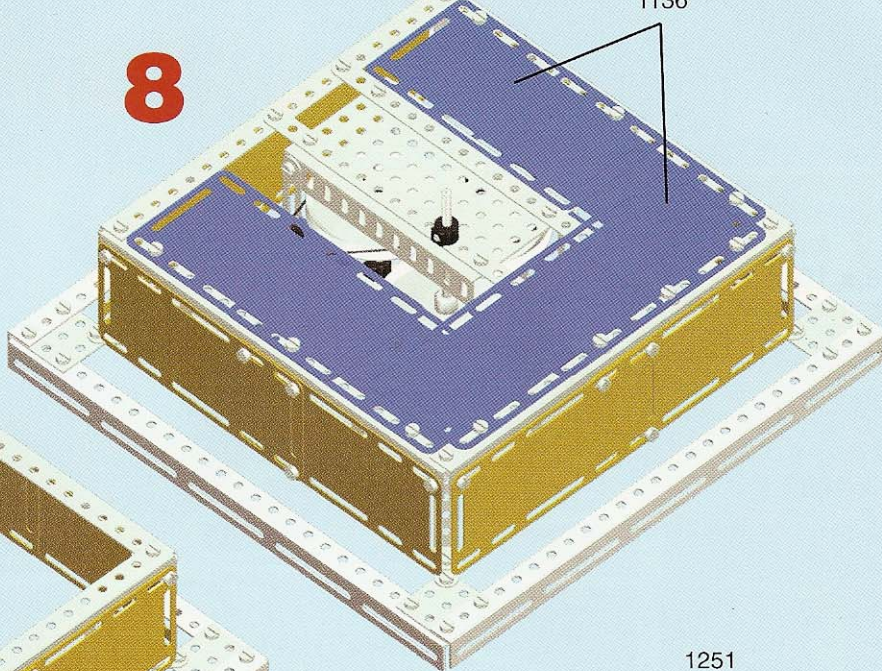

7

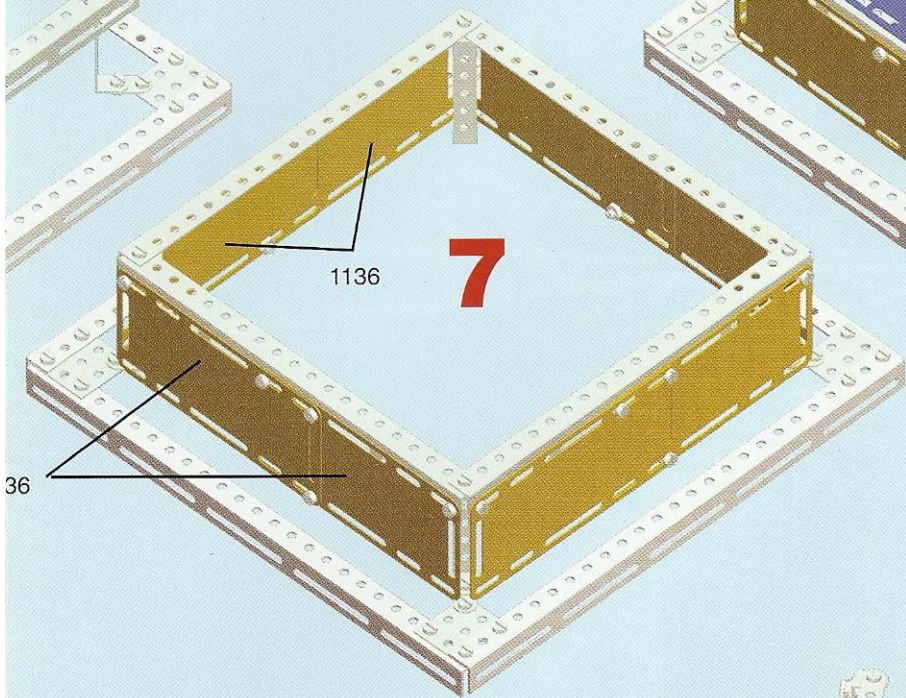

9

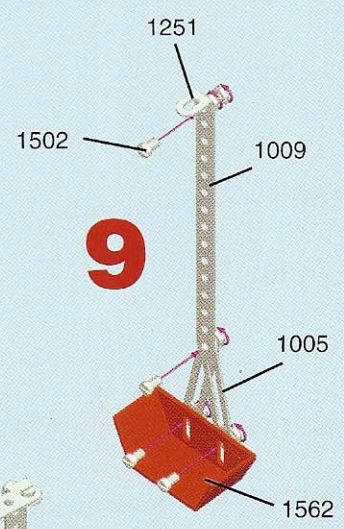

10

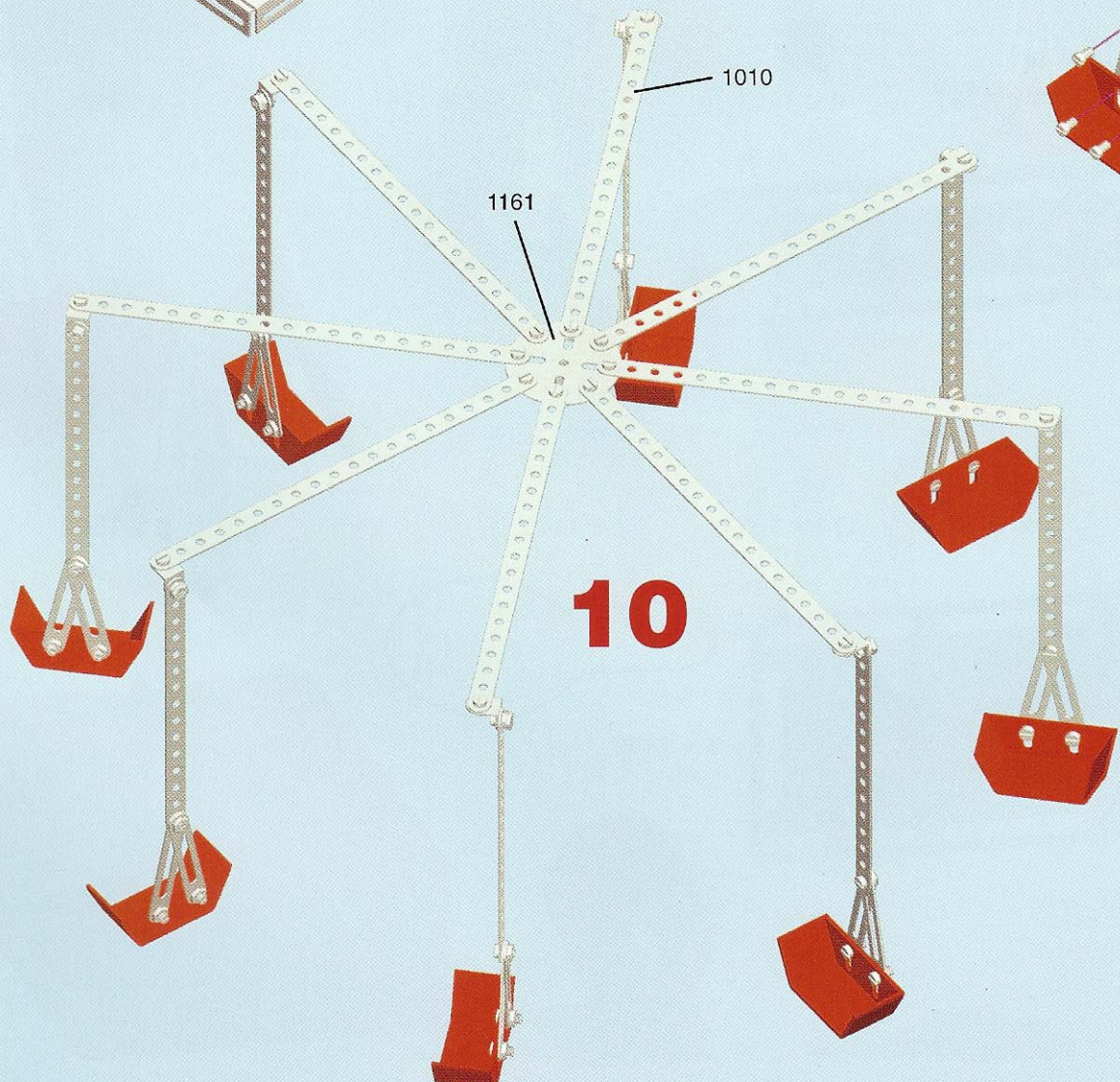

11

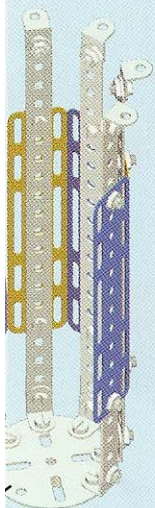



4 x 1001



19 x 1005



8 x 1009



18 x 1010



4 x 1203



4 x 1053



2 x 1352



4 x 1054



24 x 1251



1 x 1361



4 x 1102

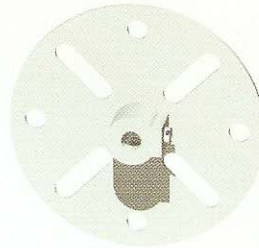

2 x 1161



3 x 1312



3 x 1151



11 x 1381



4 x 1401

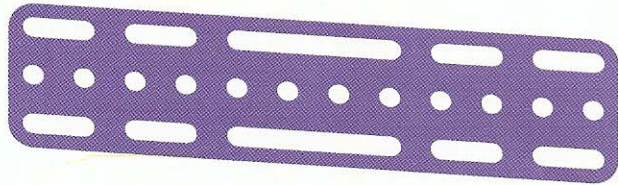

8 x 1134

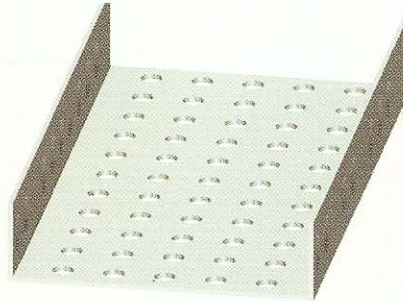

2 x 1112

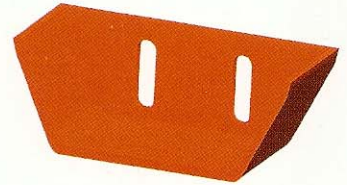

8 x 1562



158 x 1501



8 x 1502



174 x 1511

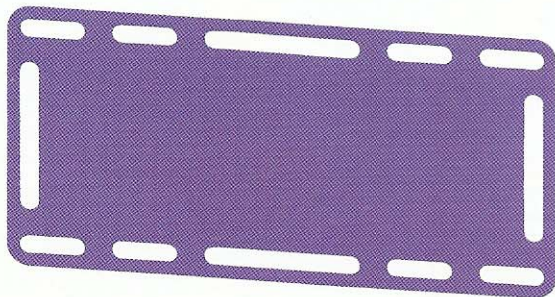

14 x 1136

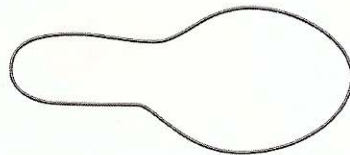

3 x 1445



3 x 1498



1 x 1492



1 x 1496

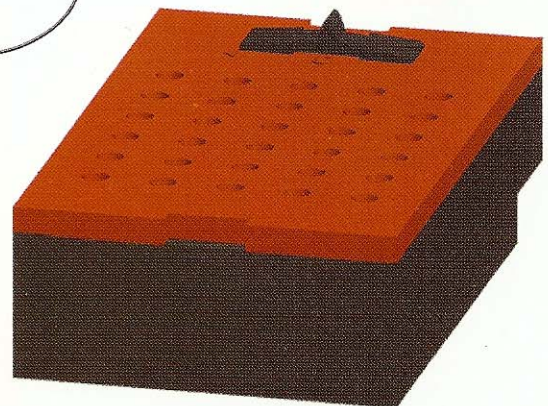

1 x 1491

Stückliste

1001	Flachstab, 2-Loch	4	1351	Achse, 35 mm	1
1005	Flachstab, 6-Loch, Langloch	24	1352	Achse, 65 mm	3
1006	Flachstab, 7-Loch	2	1361	Achse, 95 mm mit Gewindeenden	8
1009	Flachstab, 15-Loch	8	1381	Gewindestift, mit Querschlitz M 4 x 4	15
1010	Flachstab, 20-Loch	18	1401	Stellring	7
1052	Winkelstab, 15-Loch	1	1402	Elastikstellring	4
1053	Winkelstab, 20-Loch	4	1445	Gummiriemen	3
1054	Winkelstab, 25-Loch	5	1491	Batteriekasten	1
1102	Platte, 3 x 3 Loch	4	1492	Kabel, zweiadrig mit Stecker	1
1103	Platte, 7 x 3 Loch	2	1495	Motorhalterung	1
1112	Platte, 11 x 5 Loch, zweiseitig abgewinkelt	2	1496	Motor	1
1123	Trapezplatte, 7 x 5 Loch	2	1498	Keilriemenscheibe, zweirillig	3
1135	Verkleidungsplatte, 12 x 3 Loch	11	1501	Schraube M 4 x 6	164
1136	Verkleidungsplatte, 12 x 6 Loch	14	1502	Schraube M 4 x 8	8
1151	Scheibe, Ø 10 mm	23	1511	Mutter M 4	184
1161	Scheibe, Ø 50 mm mit Buchse	2	1551	Schraubendreher, 4 mm	1
1203	Bügel, 5 x 1 Loch	12	1552	Schraubendreher, 6 mm	1
1251	Winkel, 1 x 1 Loch	24	1553	Schraubenschlüssel	2
1253	Winkel, 2 x 1 Loch	4	1554	Schraubenhalter	1
1312	Schnurlaufrad, Ø 60 mm	3	1562	Sitzbank	12

15

CONSTRUCTION

590 Teile

Made in Germany

eitech

eitech GmbH
37308 Pfaffschwende



1009

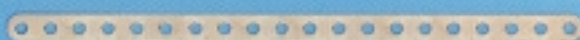

1010



1203



1253



1251



1001



1005



1006



1053



1052



1054

1445



1312



1161

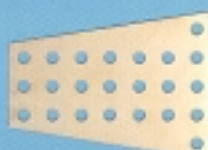

1123



1103



1102



1112



1136

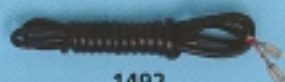

1492



1151



1511



1381



1501



1502



1402



1401



1498



1135



1552



1551



1553



1361



1352



1351

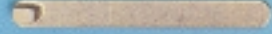

1554



1491



1495



1496



1562