

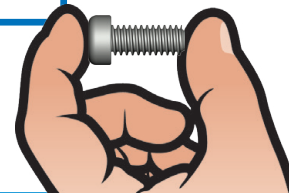

1

	9.5 mm 3/8 in 3/8 po	x1
	14.7 mm 37/64 in 37/64 po	x1
	19 mm 3/4 in 3/4 po	x2
		x4
		x2
		x2
		x1
		x1
		x1

	S2	1:1
	B1	
	S4	
	A238	

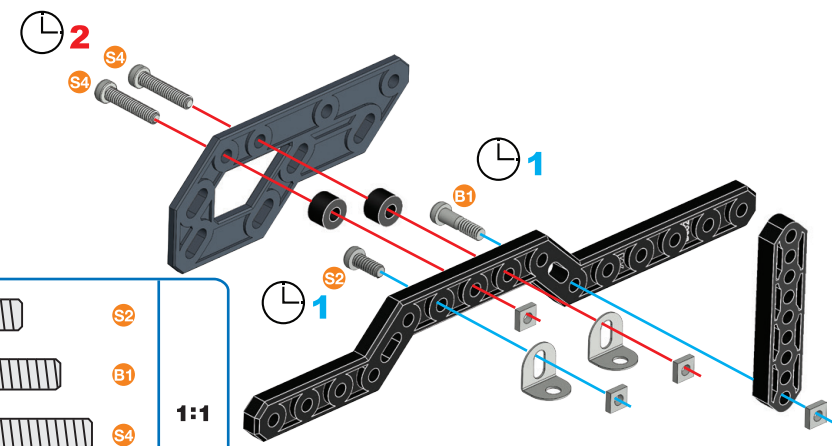

2

	9.5 mm 3/8 in 3/8 po	x1
	14.7 mm 37/64 in 37/64 po	x1
	19 mm 3/4 in 3/4 po	x2
		x4
		x2
		x2
		x1
		x1
		x1

	S2	1:1
	B1	
	B2	
	A238	

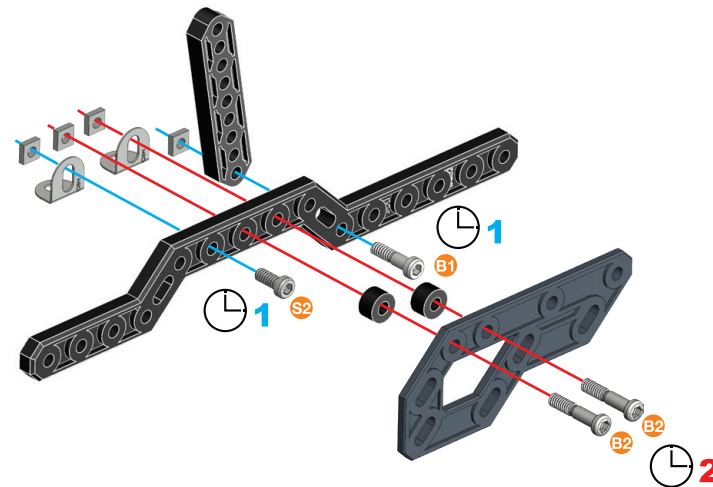



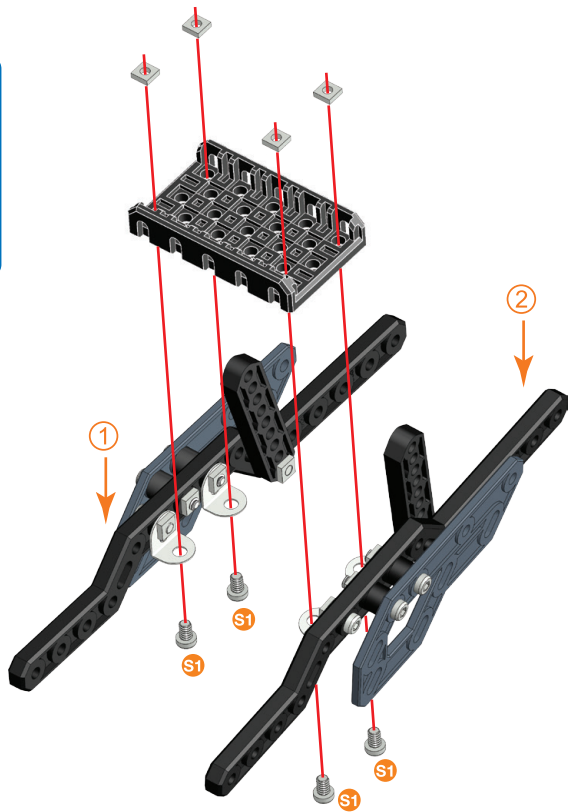

3 ①+②+

	5.8 mm 15/64 in 15/64 po	x4
		x4
		x1

	1:1
-----------------------------------------------------------------------------------	------------







4

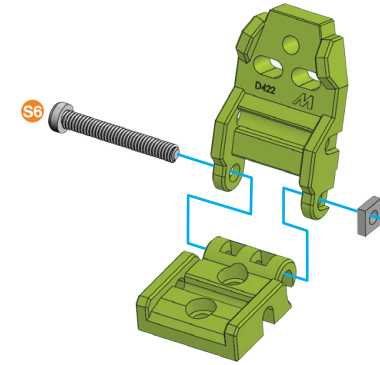

	28 mm 1 1/8 in 1 1/8 po	x1
		x1
		x1
		x1

	1:1
-------------------------------------------------------------------------------------	------------





5 ③+④+

	19 mm 3/4 in 3/4 po	x1
		x1
		x1
		x1

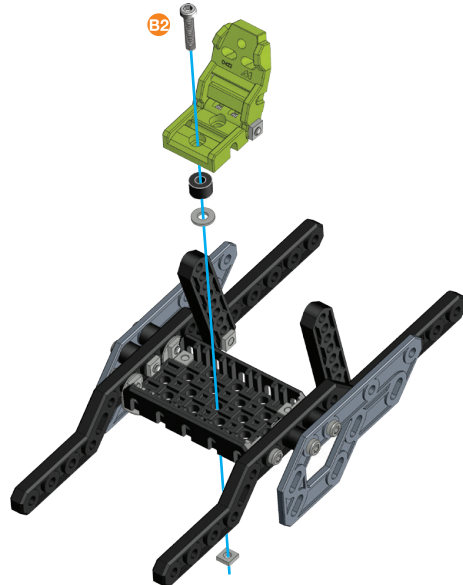
	1:1
	A238





6

	9.5 mm 3/8 in 3/8 po	x2
		x2
		x2

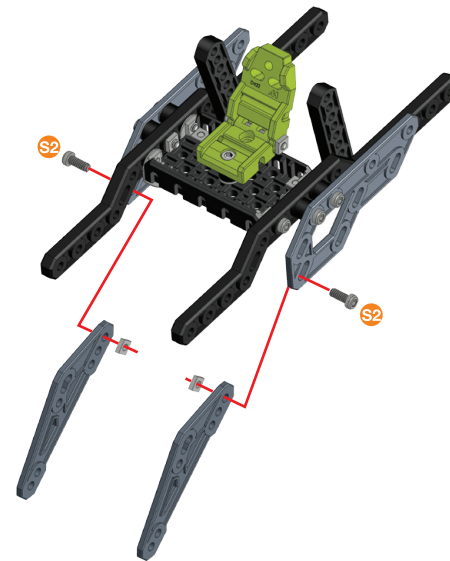
	1:1
---------------------------------------------------------------------------------------	------------





7

	5.8 mm 15/64 in 15/64 po	x2
		x2
		x2

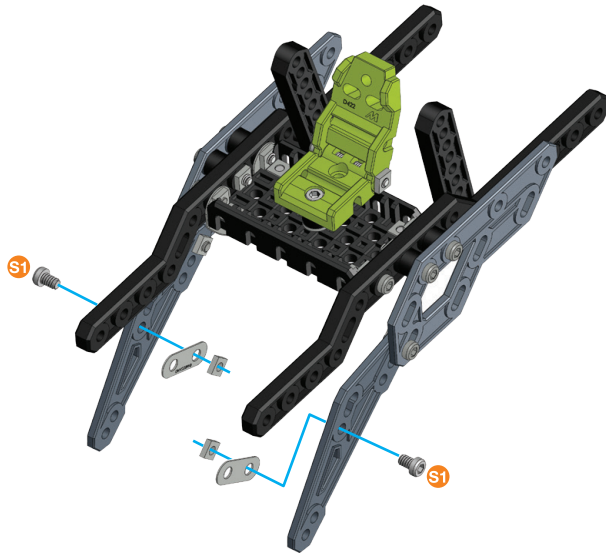
	S1	1:1
----------------------------------------------------------------------------------	----	-----





8

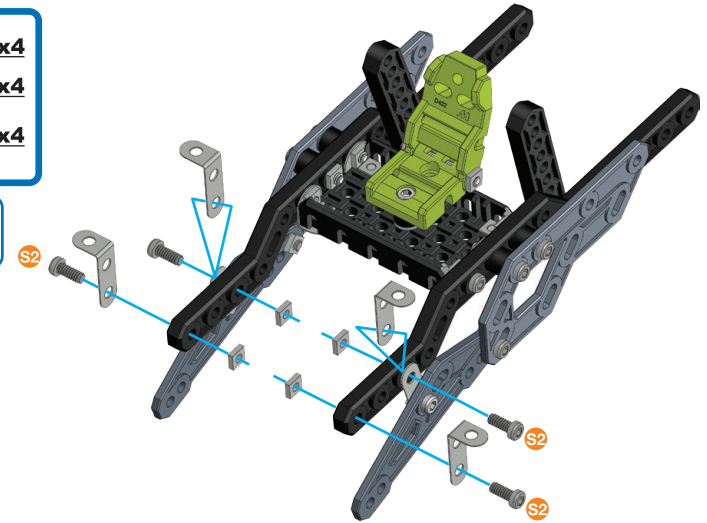

	9.5 mm 3/8 in 3/8 po	x4
		x4
		x4

	S2	1:1
-------------------------------------------------------------------------------------	----	-----



9

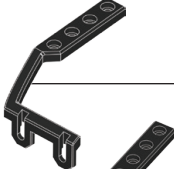

	5.8 mm 15/64 in 15/64 po	x4
		x4

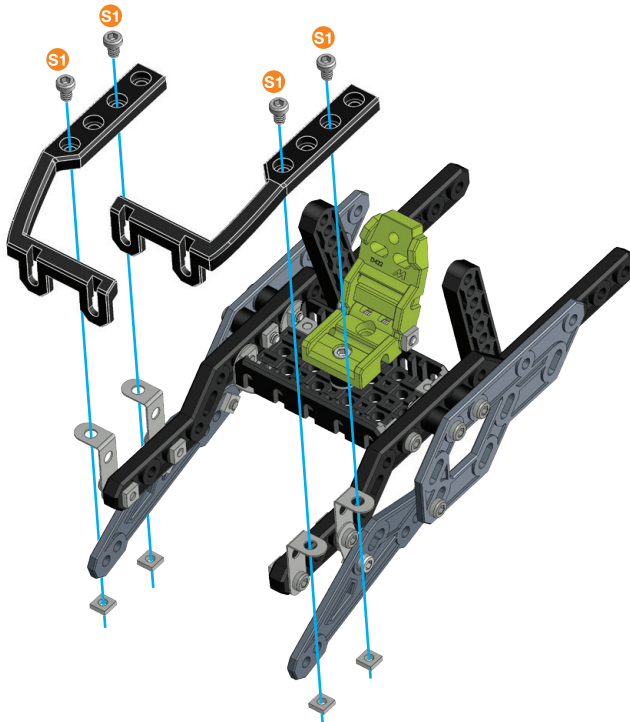

		x1
		x1

	S1	1:1
------------------------------------------------------------------------------------	----	-----



10



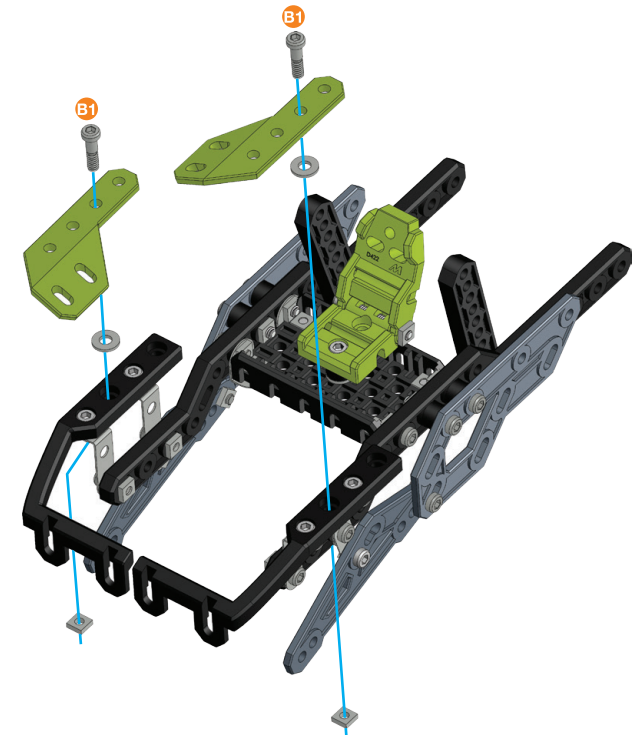

	14.7 mm 37/64 in 37/64 po	x2
		x2
		x2

		x1
		x1

	B1	1:1
---------------------------------------------------------------------------------------	----	-----





11

-  S1 | 5.8 mm | x2
15/64 in | 15/64 po
-  S2 | 9.5 mm | x2
3/8 in | 3/8 po
-  x4
-  x2
-  x1

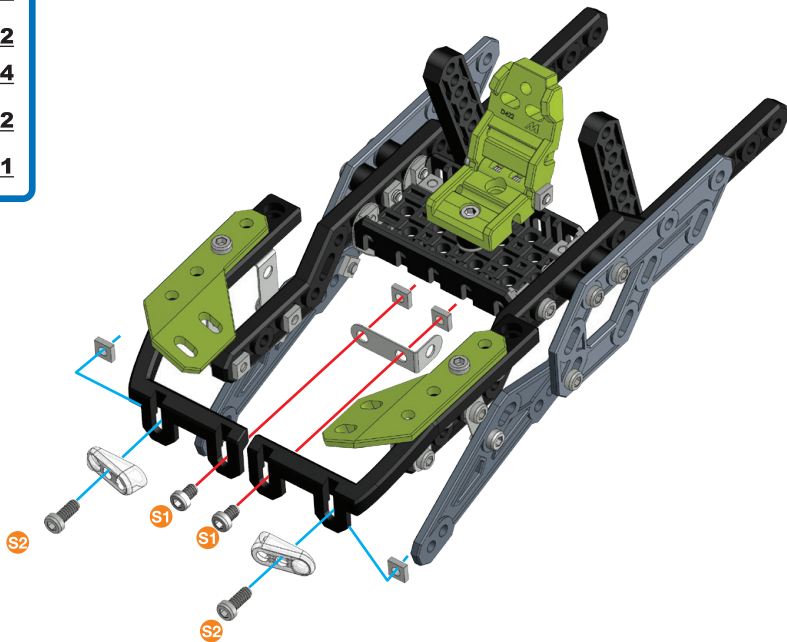
-  S1 | 1:1
-  S2 | 1:1





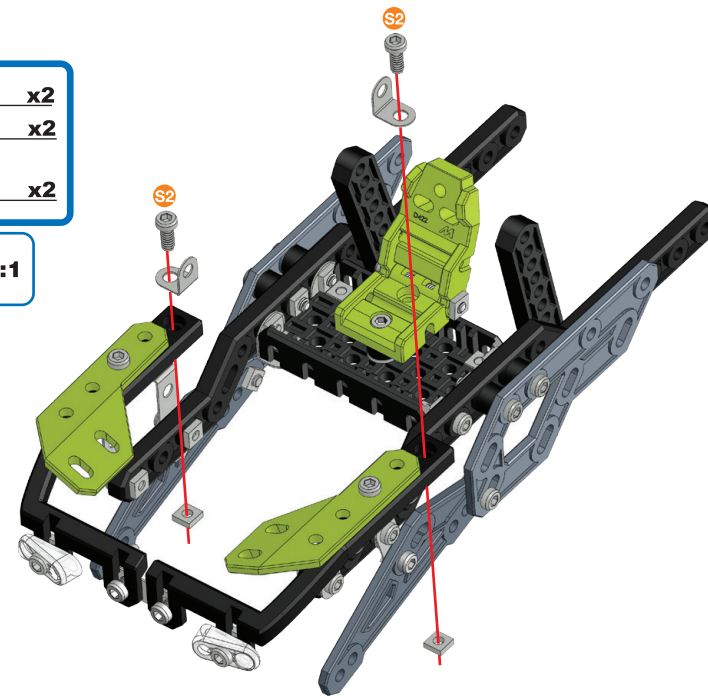

12

-  S2 | 9.5 mm | x2
3/8 in | 3/8 po
-  x2
-  x2

-  S2 | 1:1



13

-  S1 | 5.8 mm | x3
15/64 in | 15/64 po
-  x3
-  x5
-  x1

-  S1 | 1:1

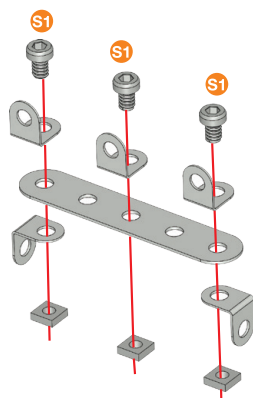

14

-  S2 | 9.5 mm | x2
3/8 in | 3/8 po
-  x2
-  x2

-  S2 | 1:1

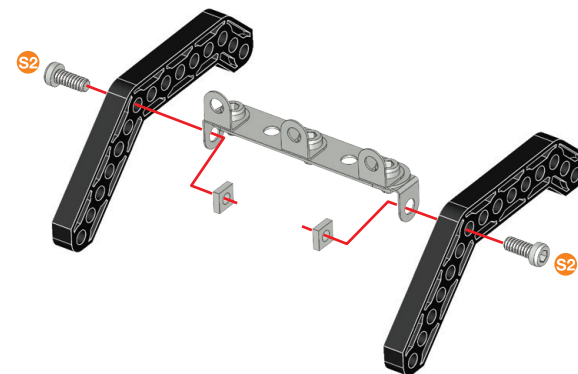

15

12+14+

- S2 9.5 mm | 3/8 in | 3/8 po | x2
- B1 14.7 mm | 37/64 in | 37/64 po | x2
- x4

- S2 1:1
- B1 1:1

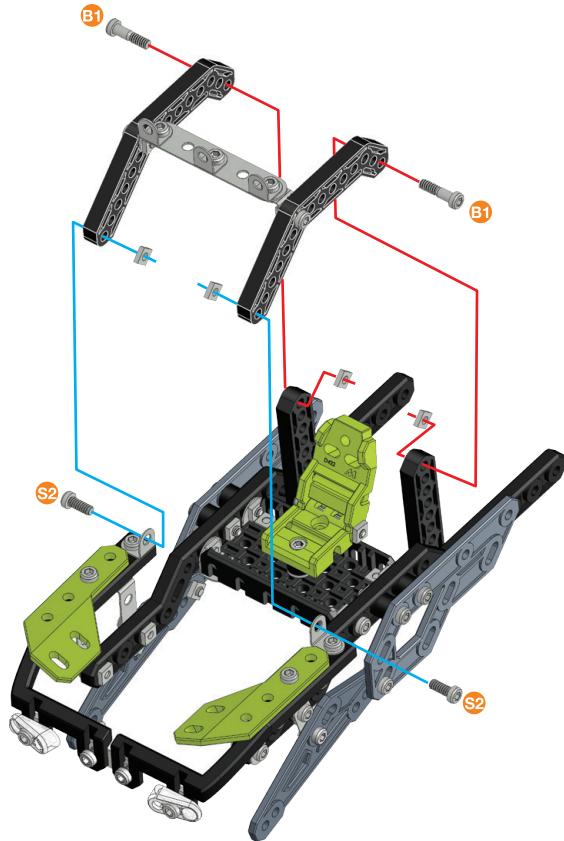

16

- S1 5.8 mm | 15/64 in | 15/64 po | x2
- x2
- x2
- x1

- S1 1:1

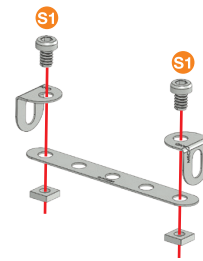

17

- S3 12 mm | 1/2 in | 1/2 po | x2
- x2
- x1
- x1

- S3 1:1
- A338

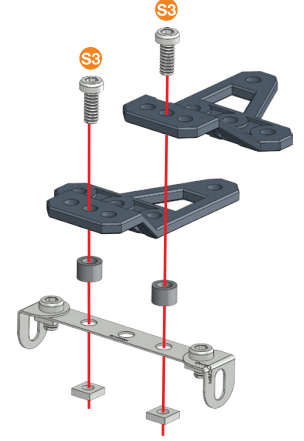



18

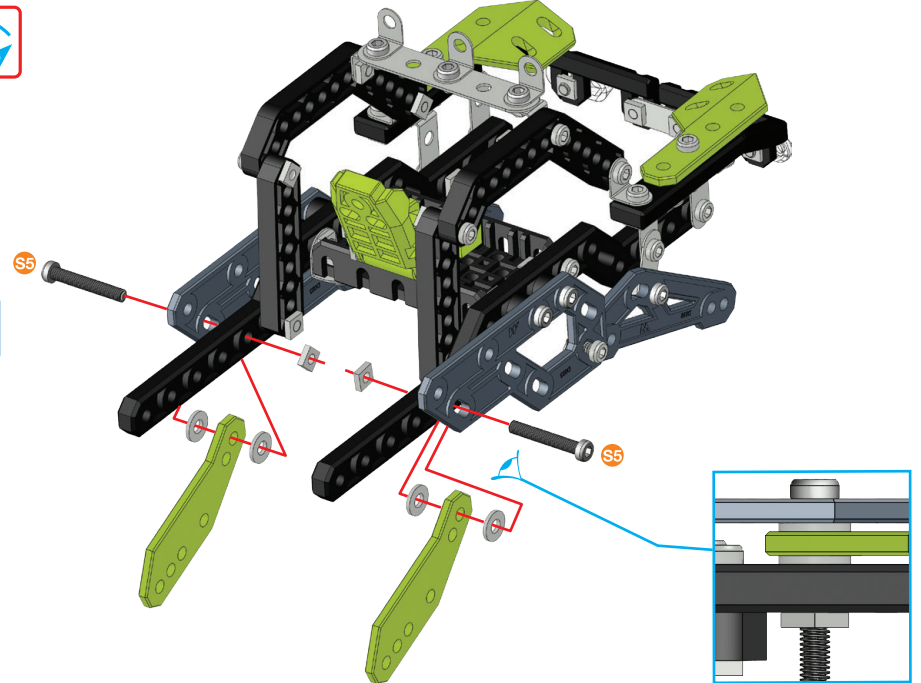

- S5 25.4 mm | 1 in | 1 po | x2
- x2
- x4
- x2

- S5 1:1



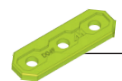



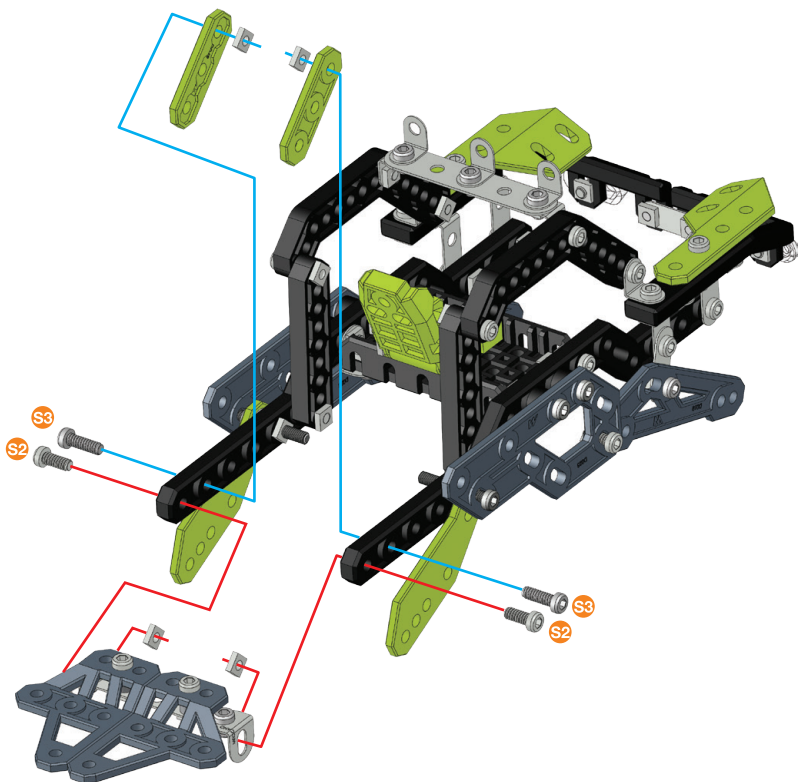

19**17+18+**

	9.5 mm 3/8 in	x2
	12 mm 1/2 in	x2
		x4
		x2

	S2	1:1
	S3	



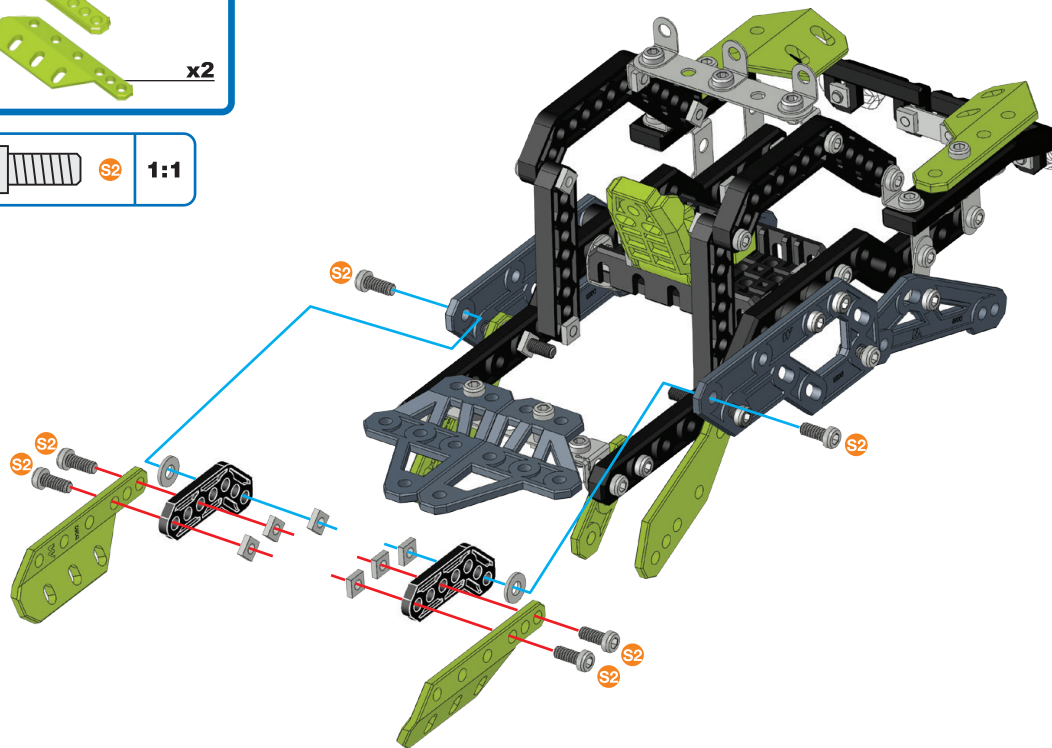

**20**

	9.5 mm 3/8 in	x6
		x6
		x2
		x2
		x2
		x2

	S2	1:1
-------------------------------------------------------------------------------------	-----------	------------



21

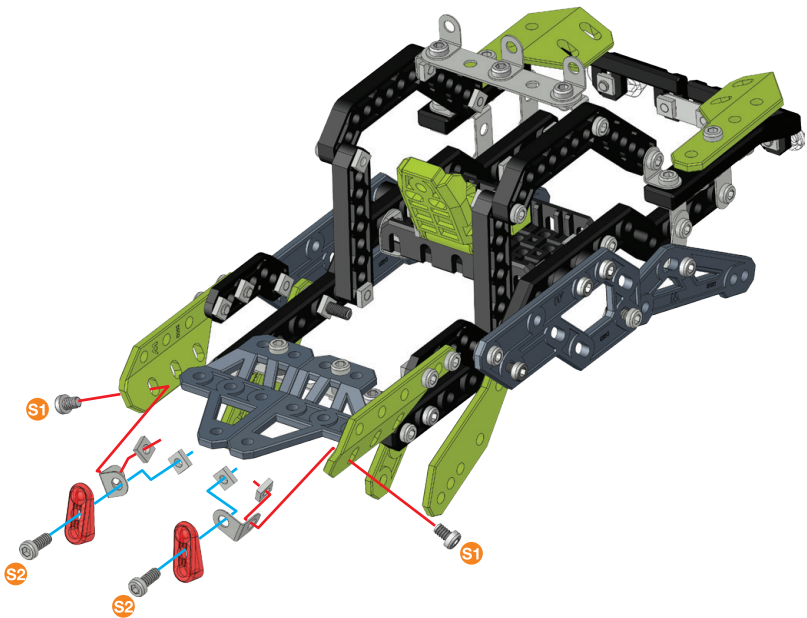

-  5.8 mm | 15/64 in | 15/64 po | **x2**
-  9.5 mm | 3/8 in | 3/8 po | **x2**
-  **x4**
-  **x2**
-  **x2**

-  **S1** | **1:1**
-  **S2**



22



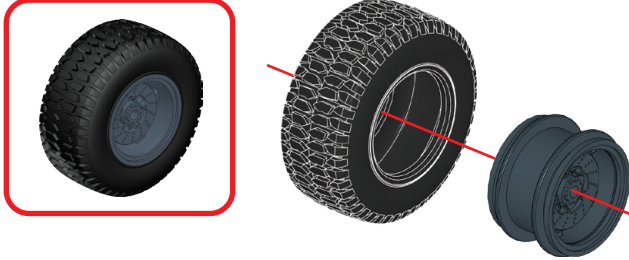

x4

-  **x4**
-  **x4**

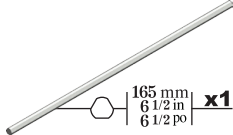

23

②1+②2+

-  165 mm | 6 1/2 in | 6 1/2 po | **x1**
-  **x2**
-  **x2**
-  **x6**

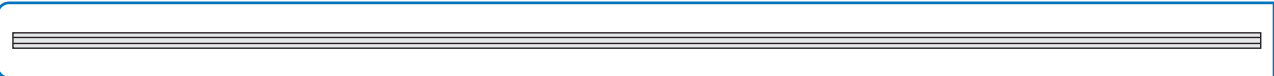
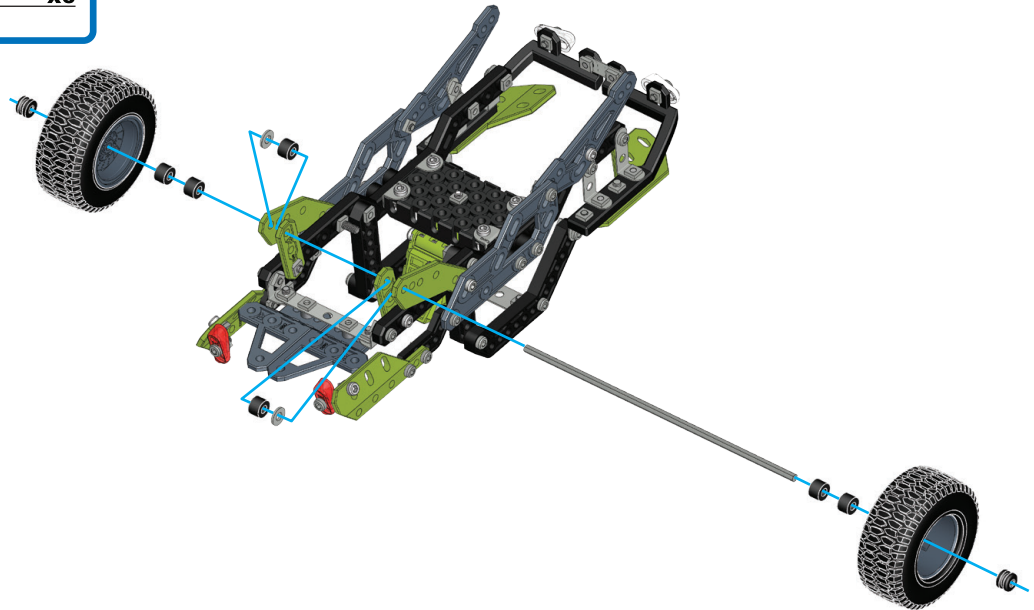

-  **A238** | **1:1**



1:1

24

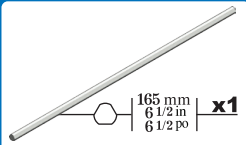
22+23+

-  165 mm
6 1/2 in
6 1/2 po | **x1**
-  **x2**
-  **x4**

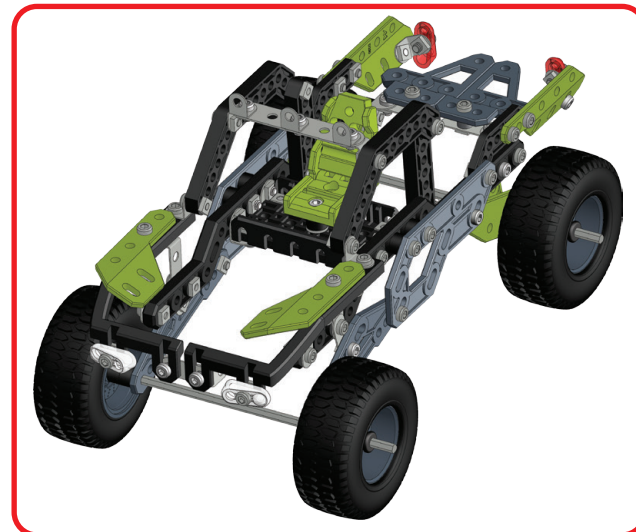

-  **A238** | **1:1**

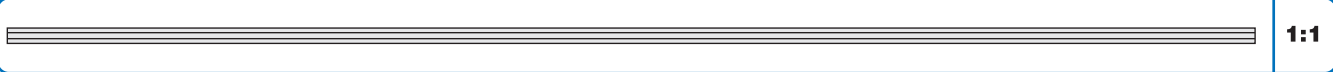
-  **1:1**