

29

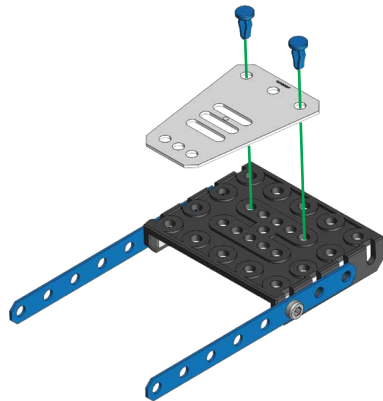

30

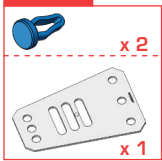

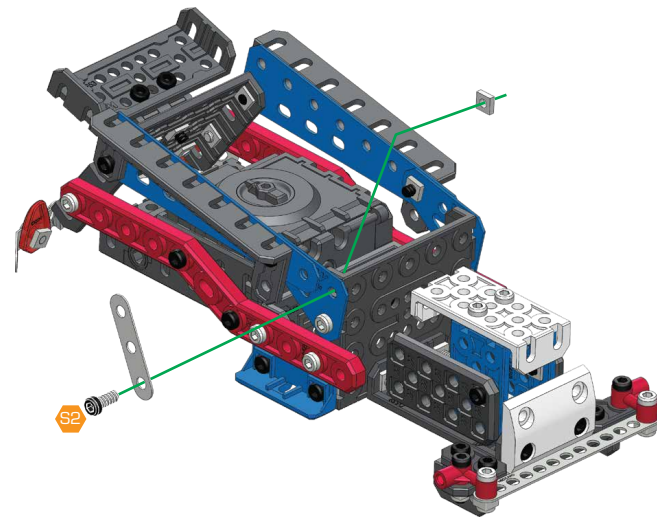
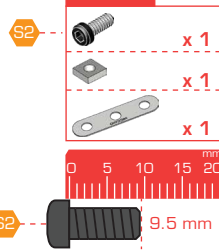

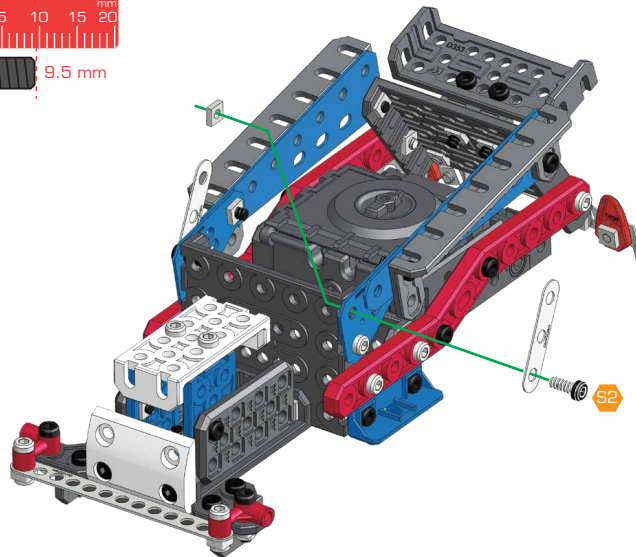
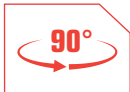
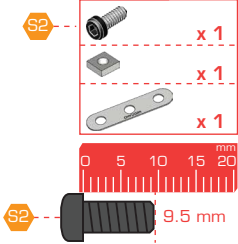

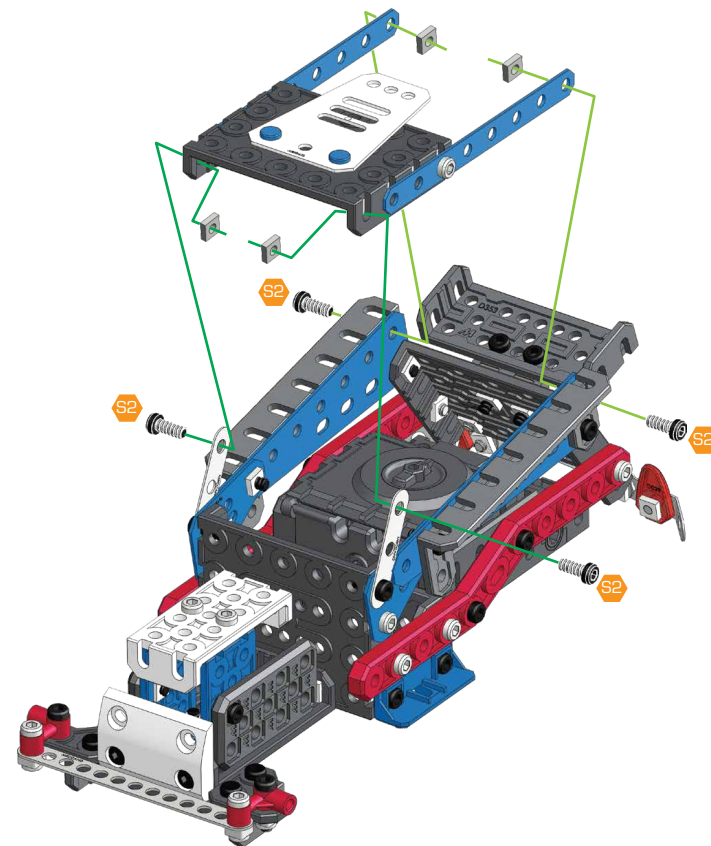
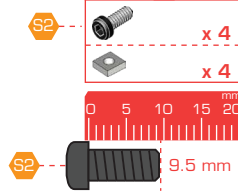

31

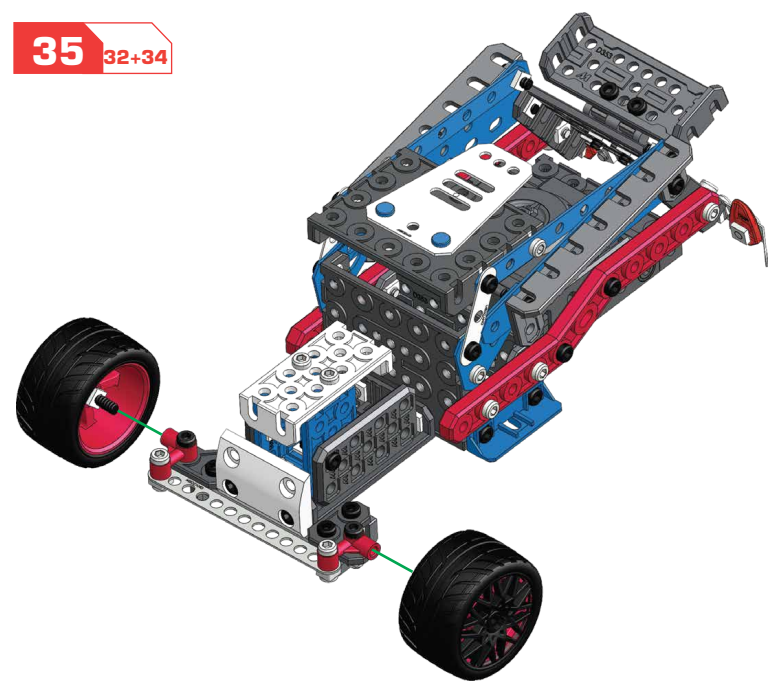
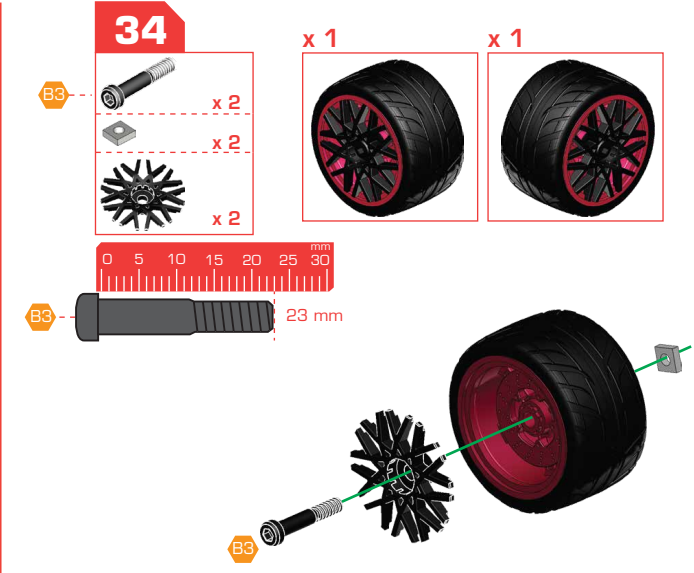

32 29+31





- 36** 33+35
-  x 1
 -  x 2
 -  x 2
 -  x 2
 -  x 2

