

1

- 9.5 mm | 3/8" | **x2**
- 14.7 mm | 37/64" | **x2**
- x4**
- x1**
- x1**
- x1**
- x1**

- B1**
- S2**
- 1:1**

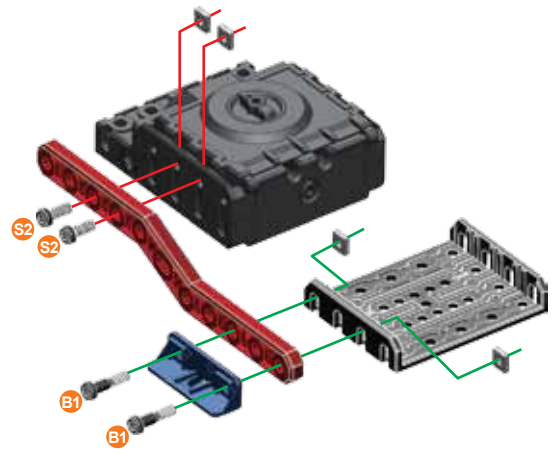

2

- 9.5 mm | 3/8" | **x2**
- x2**
- x1**
- x1**

- S2**
- 1:1**

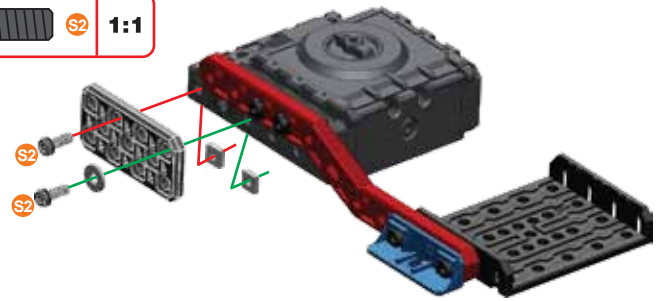

3

- 9.5 mm | 3/8" | **x4**
- 14.7 mm | 37/64" | **x2**
- x6**
- x1**
- x1**
- x1**
- x1**

- B1**
- S2**
- 1:1**

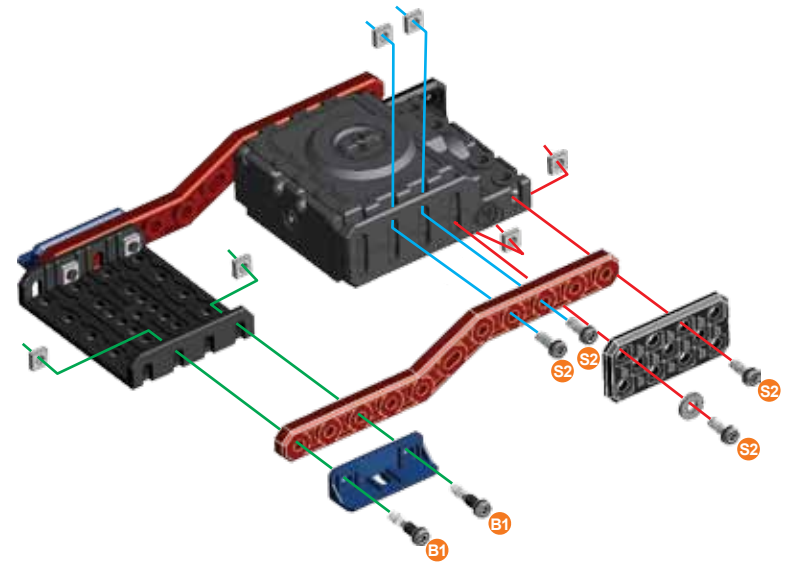

4

- 9,5 mm | 3/8" | x3
- x3
- x1

- 1:1



5

- 9,5 mm | 3/8" | x3
- x3
- x1

- 1:1

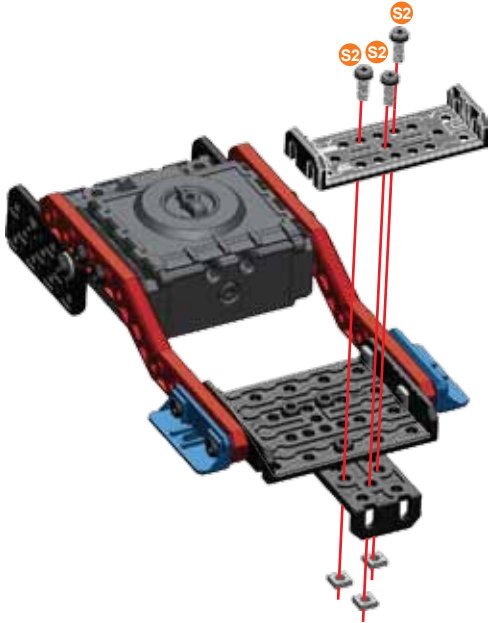

6

- 9,5 mm | 3/8" | x4
- x4
- x2

- 1:1

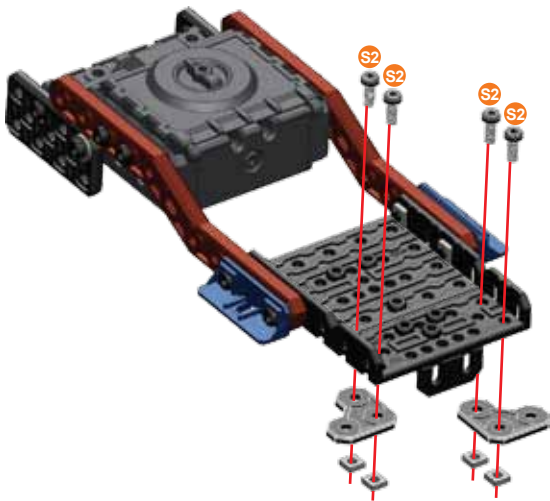

7

- 9,5 mm | 3/8" | x2
- x2
- x1

- 1:1

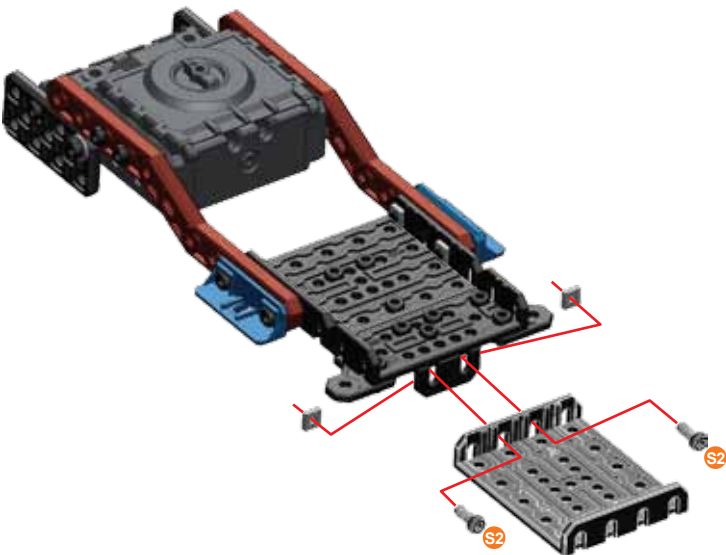

8

- S3 | 12 mm | 1/2" | x2
- B1 | 14.7 mm | 37/64" | x2
- | x4
- | x2
- | x1

- S3
- B1
- 1:1

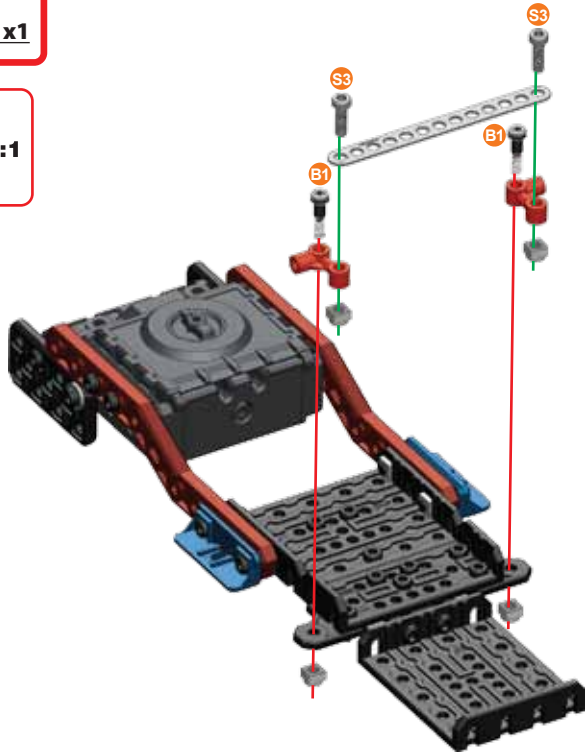





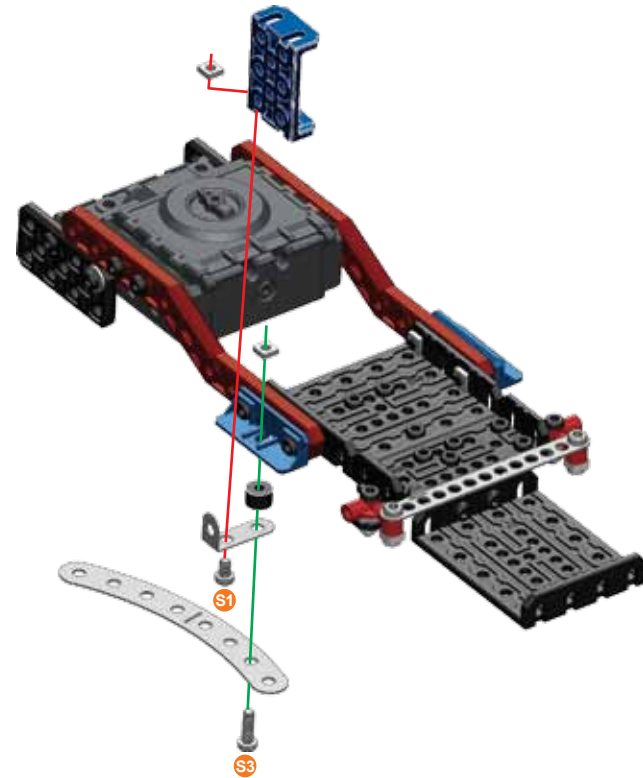

9

- S1 | 5.8 mm | 15/64" | x1
- S3 | 12 mm | 1/2" | x1
- | x2
- | x1
- | x1
- | x1
- | x1



- S1
- S3
- A238
- 1:1





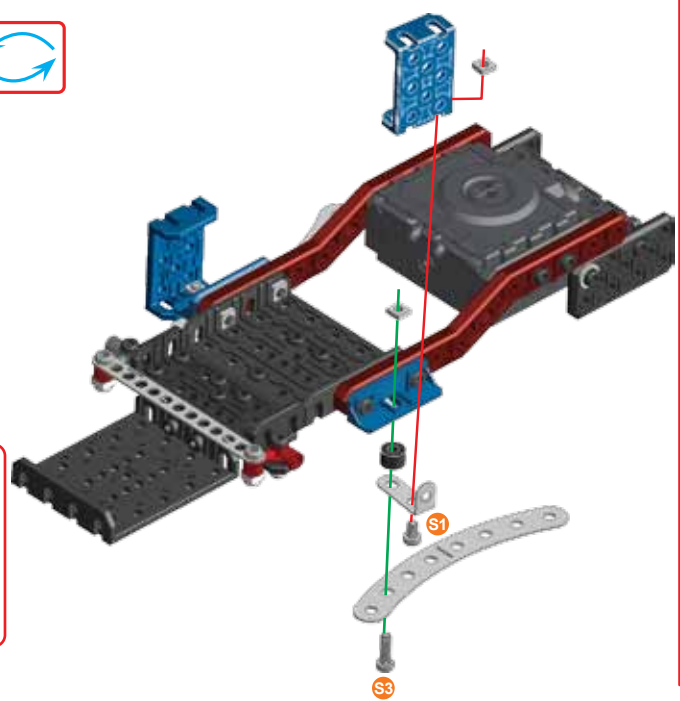



10



-  5.8 mm | 15/64" | x1
-  12 mm | 1/2" | x1
-  x2
-  x1
-  x1
-  x1
-  x1



-  S1
-  S3
-  A238
- 1:1





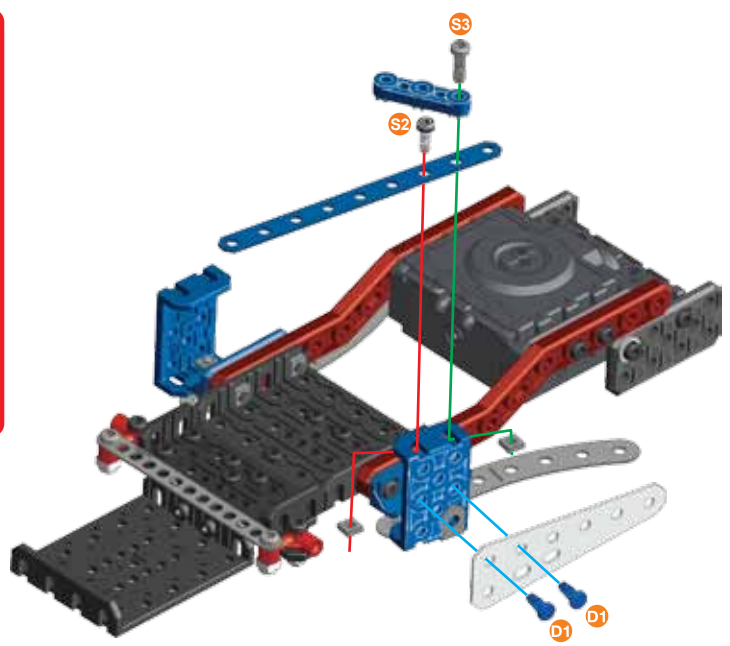

11

-  9.5 mm | 3/8" | x1
-  12 mm | 1/2" | x1
-  11.25mm | 7/16" | x2
-  x2
-  x1
-  x1
-  x1



-  S2
-  S3
-  D1
- 1:1





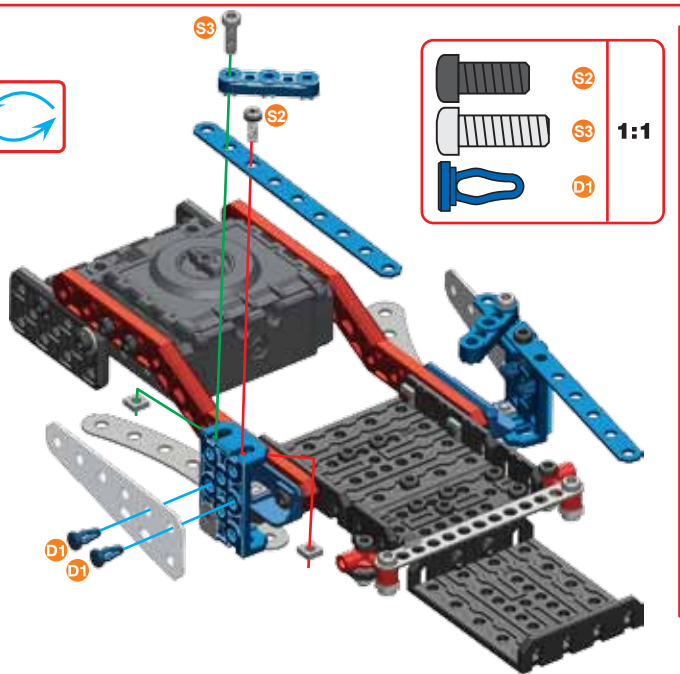



12



-  9.5 mm | 3/8" | x1
-  12 mm | 1/2" | x1
-  11.25mm | 7/16" | x2
-  x2
-  x1
-  x1
-  x1



-  S2
-  S3
-  D1
- 1:1





13

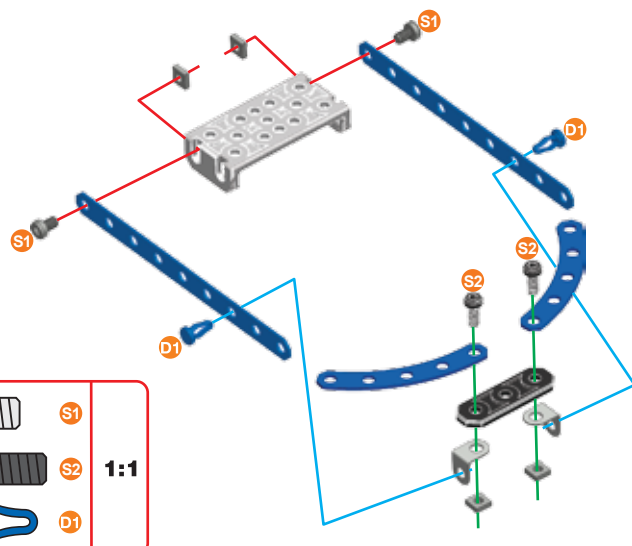

-  11.25mm | 7/16" | x2
-  5.8 mm | 15/64" | x2
-  9.5 mm | 3/8" | x2
-  x4
-  x2
-  x1
-  x2

-  S1
-  S2
-  D1
- 1:1





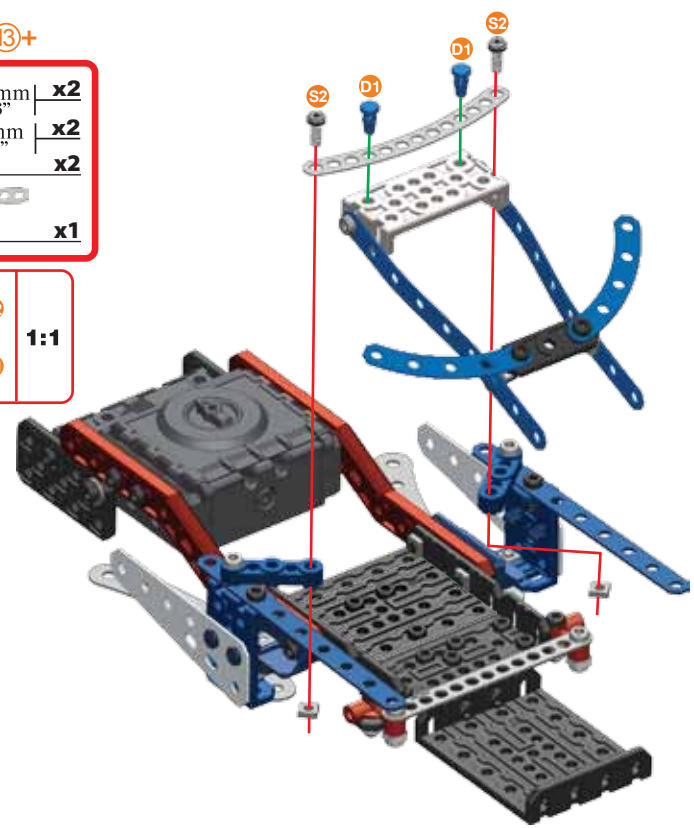

14 ⑫+⑬+

	D1	11.25mm 7/16"	x2
	S2	9.5 mm 3/8"	x2
	S2		x2
			x1

	S2	1:1
	D1	





15

	S1	5.8 mm 15/64"	x4
	S1		x4
			x2
			x2

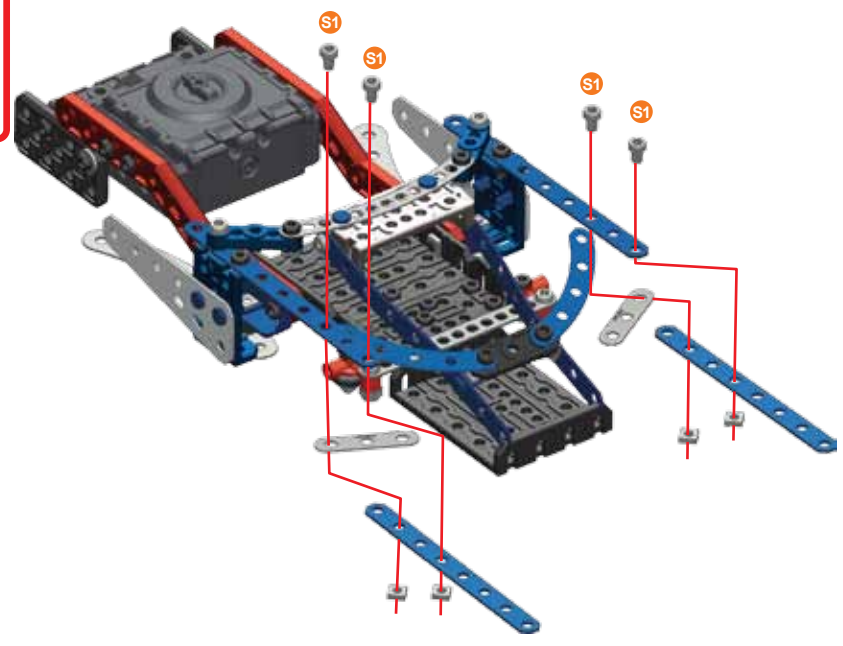
	S1	1:1
---	----	-----





16

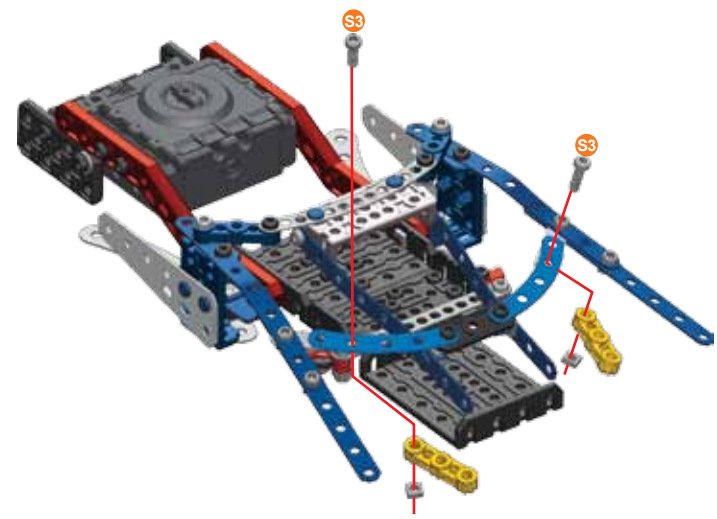

	S3	12 mm 1/2"	x2
	S3		x2
			x2

	S3	1:1
---	----	-----



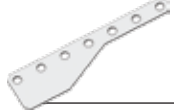

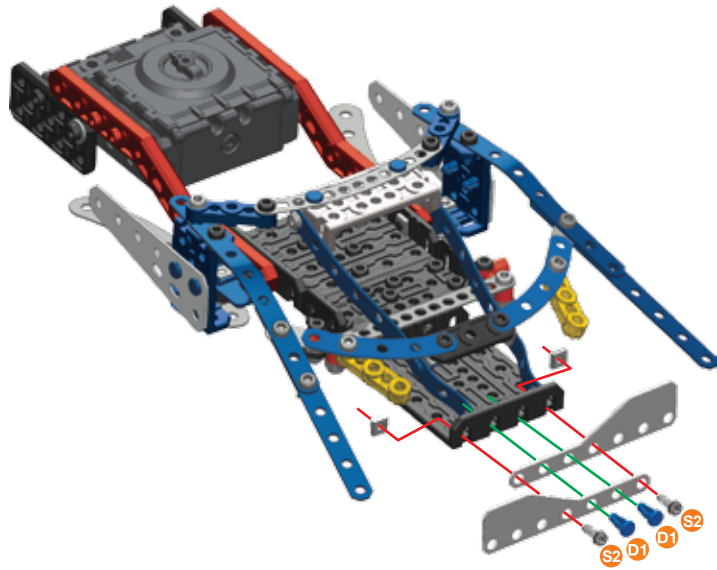

17

	D1	11.25mm 7/16"	x2
	S2	9.5mm 3/8"	x2
	S2		x2
			x2

	S2	1:1
	D1	





18

	S1	5.8mm 15/64"	x2
	S1		x2
			x2
			x2

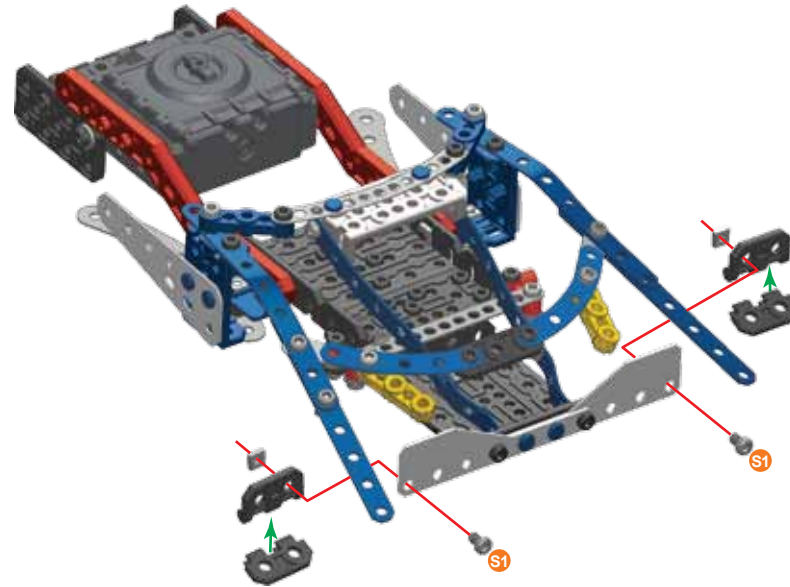
	S1	1:1
---	----	-----







19

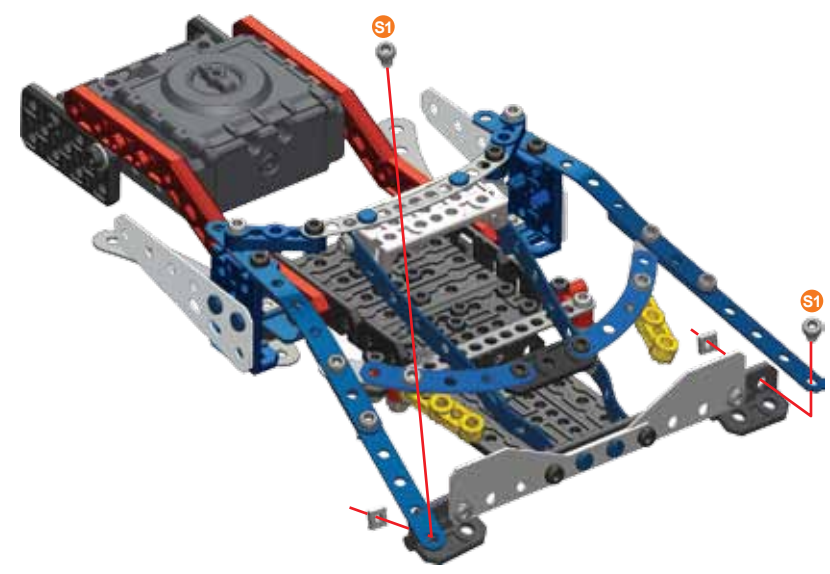

	S1	5.8 mm	x2
		15/64"	x2

	S1	1:1
---	----	-----



20

	S2	9.5 mm	x2
	S3	12 mm	x2
			x4
			x2
			x2

	S2	1:1
	S3	

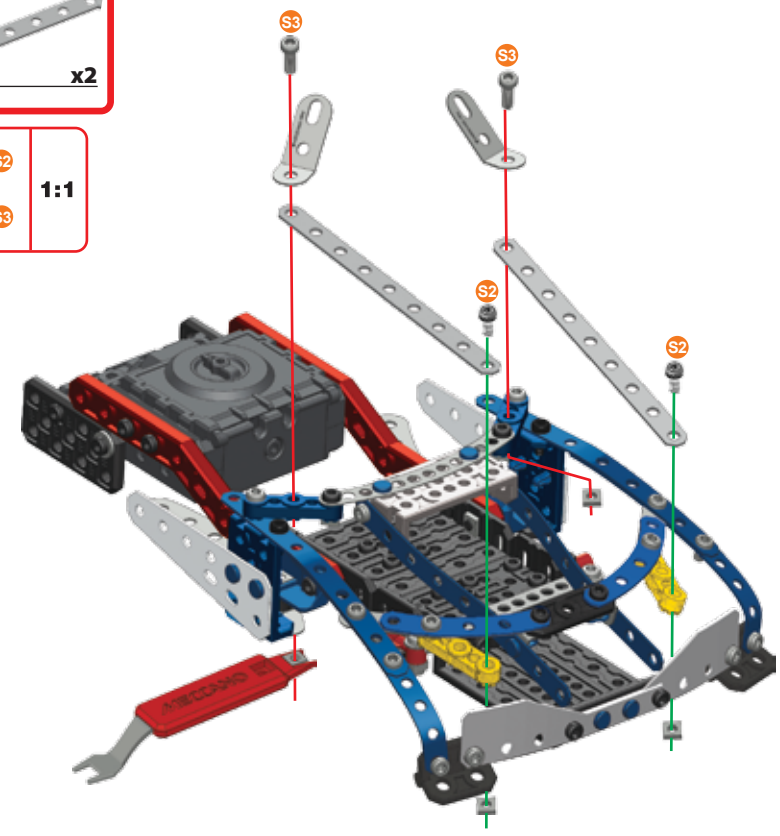

21

	S1	5,8 mm 15/64"	x2
	S2	9,5 mm 3/8"	x2
			x4
			x2
			x2



	S1	1:1
	S2	

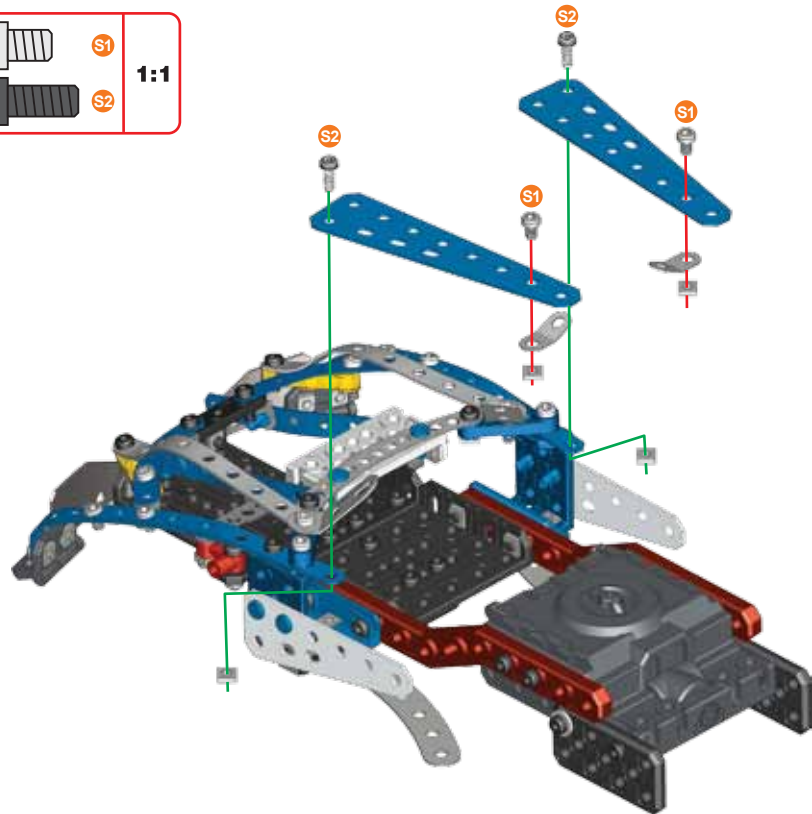

22

	S2	9,5 mm 3/8"	x2
	S3	12 mm 1/2"	x2
			x4
			x1
			x2

	S2	1:1
	S3	

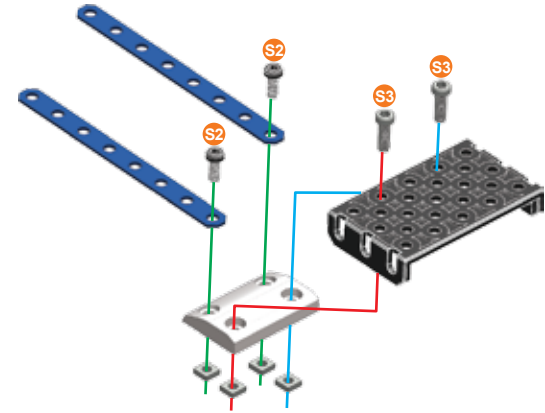



23

	D1	11,25mm 7/16"	x2
	S1	5,8 mm 15/64"	x2
			x2
			x2
			x2

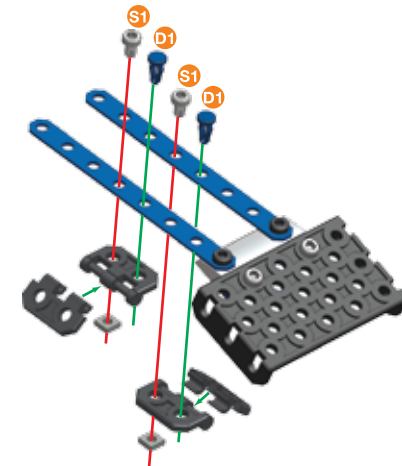
	S1	1:1
	D1	





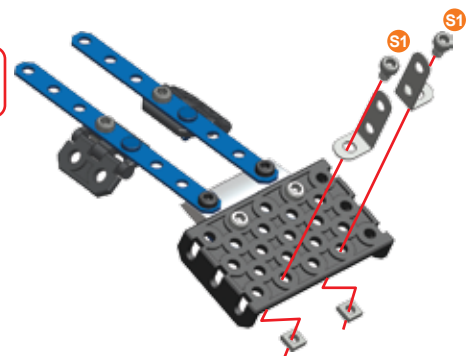

24

-  5.8 mm | 15/64" | **x2**
-  **x2**
-  **x2**

-  **S1** | **1:1**







25

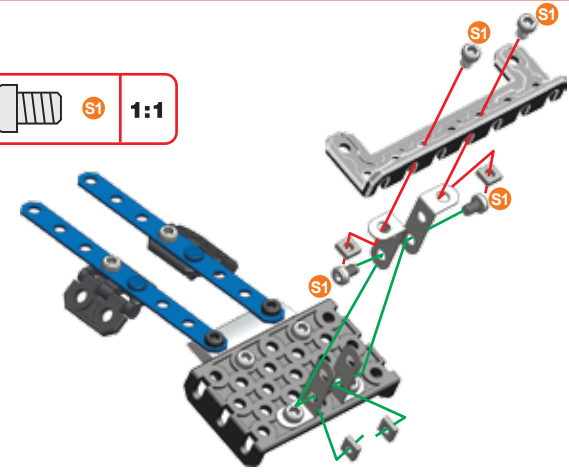

-  5.8 mm | 15/64" | **x4**
-  **x4**
-  **x2**
-  **x1**

-  **S1** | **1:1**







26

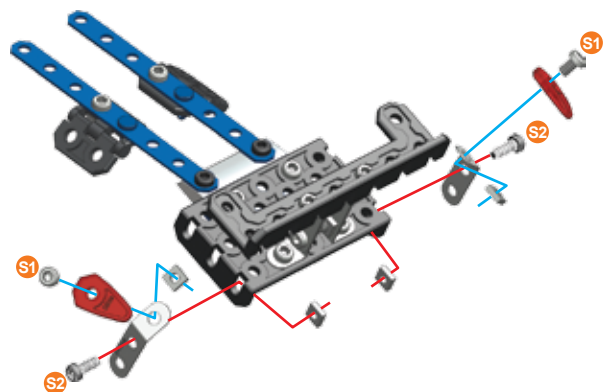

-  5.8 mm | 15/64" | **x2**
-  9.5 mm | 3/8" | **x2**
-  **x4**
-  **x2**
-  **x2**

-  **S1**
-  **S2**
- 1:1**





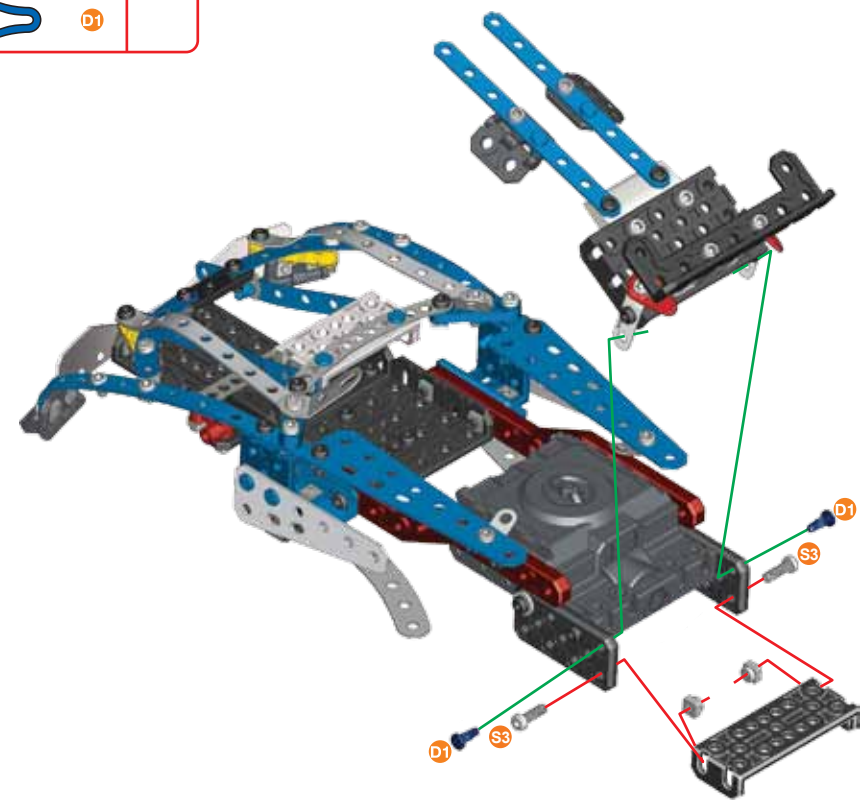

27

-  11.25mm | 7/16" | **x2**
-  12 mm | 1/2" | **x2**
-  **x2**
-  **x1**

-  **S3**
-  **D1**
- 1:1**





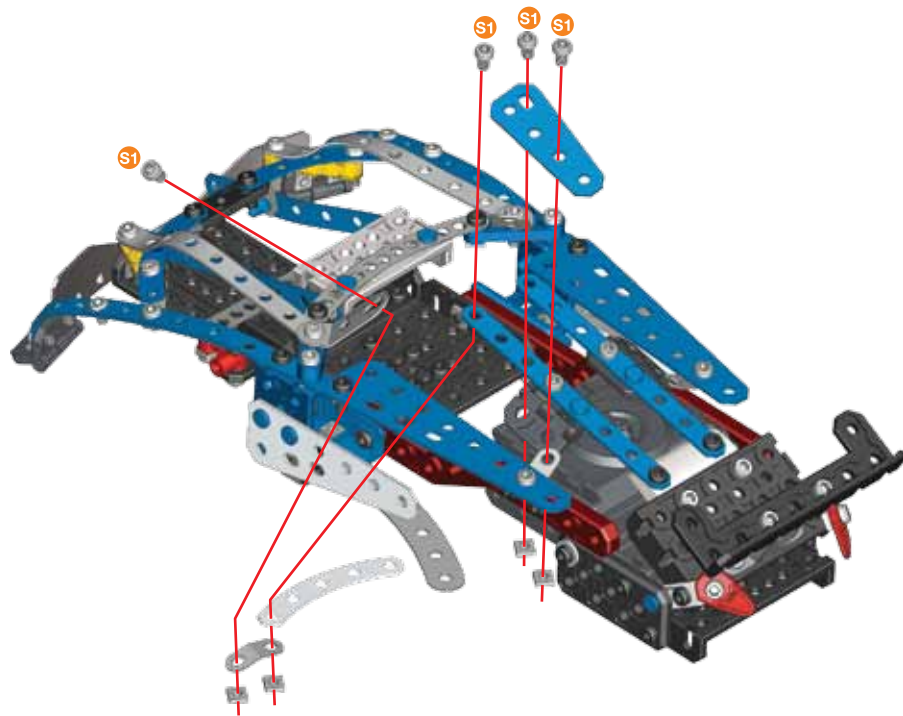

28

 S1	5.8 mm 15/64"	x4
		x4
		x1
		x1
		x1

 S1	1:1
--	-----



29

 S1	5.8 mm 15/64"	x4
		x4
		x1
		x1



 S1	1:1
--	-----

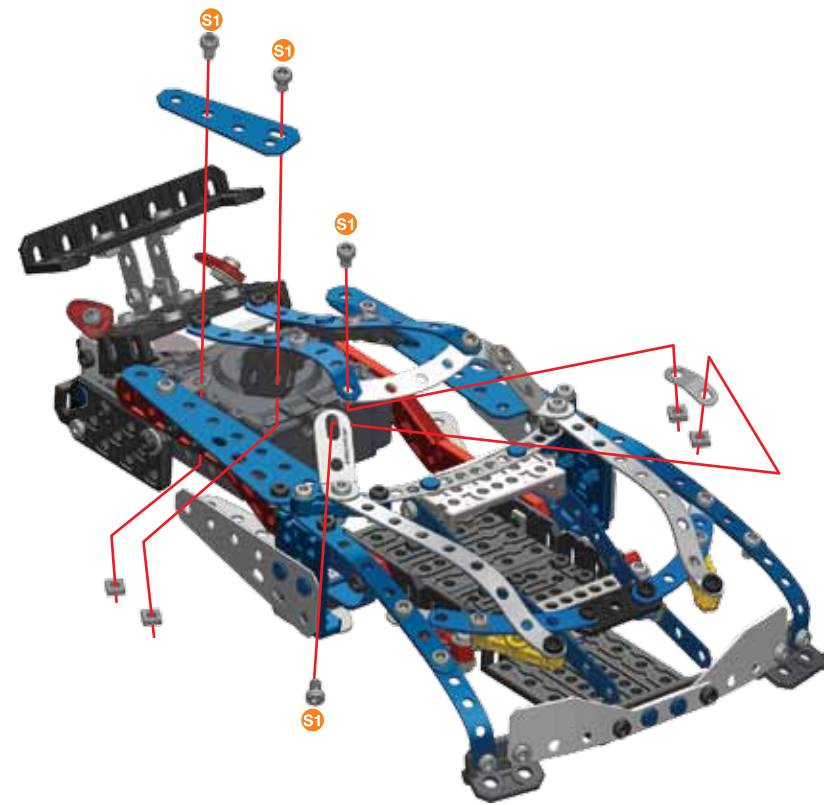

30

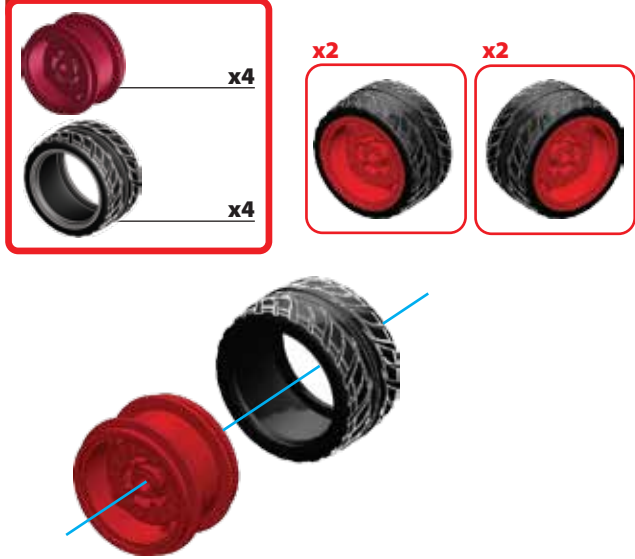

31 $\text{\textcircled{29}} + \text{\textcircled{30}} +$

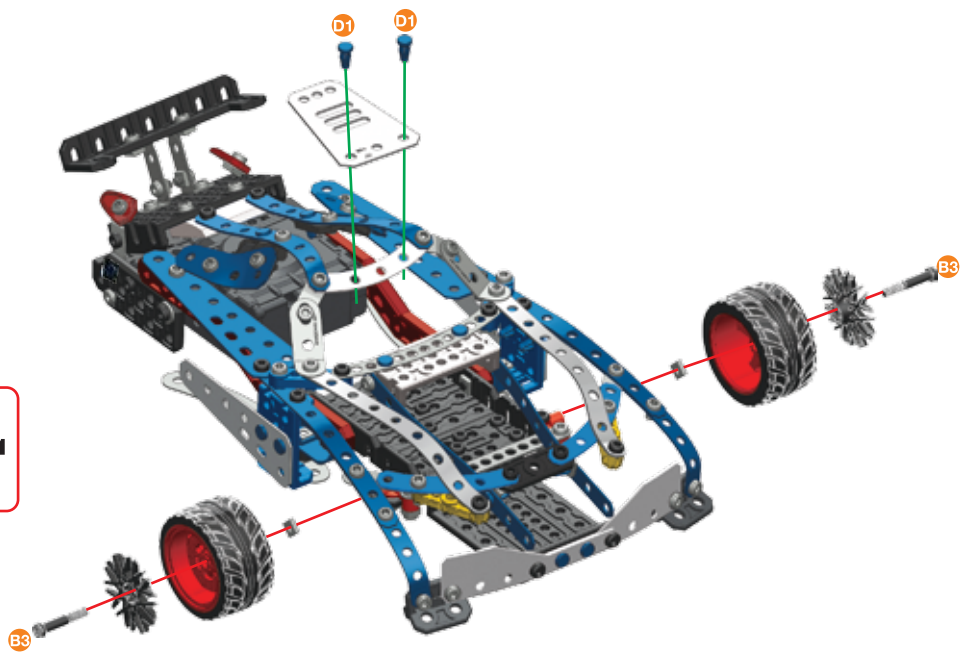
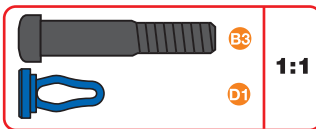
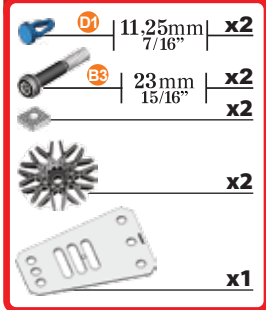

32 $\text{\textcircled{30}} + \text{\textcircled{31}} +$

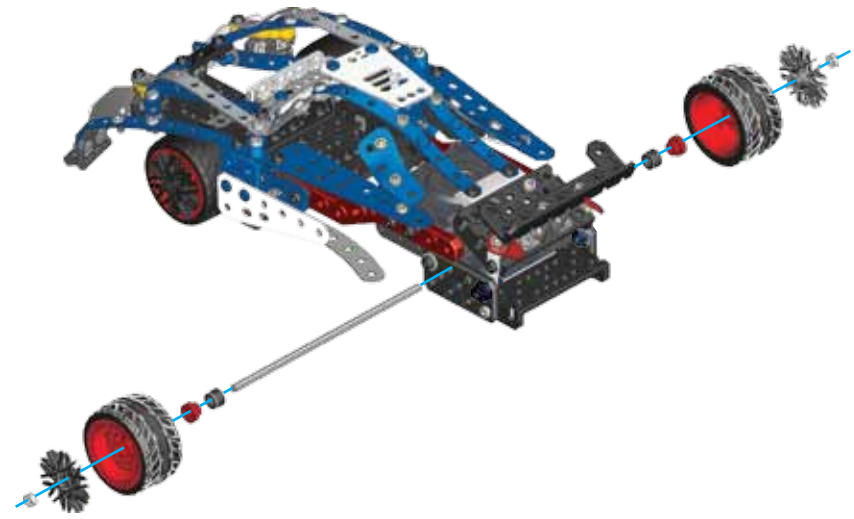
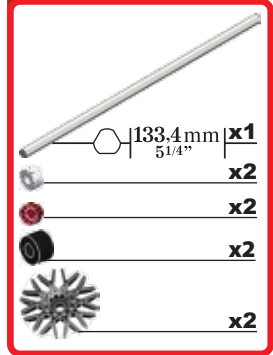

33

	D1	11.25mm 7/16"	x2
	S1	5.8mm 15/64"	x2
	S1		x2
	S1		x2
	D1		x2

