

1

- 9.5 mm | 3/8" | x2
- x2
- x1
- x1

- S2 | 1:1

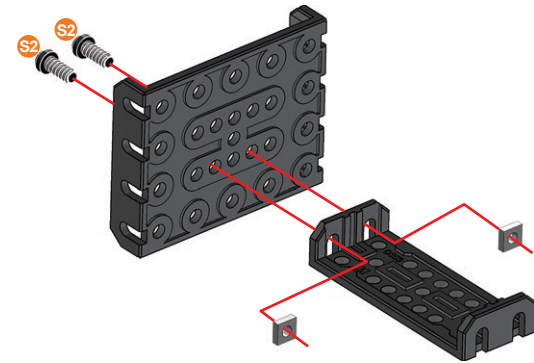

2

- 9.5 mm | 3/8" | x2
- 12 mm | 1/2" | x2
- x4
- x1
- x1

- S2 | 1:1
- S3 | 1:1

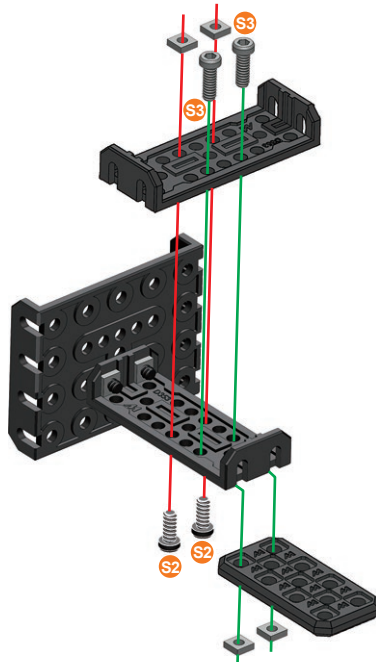



3

- 9.5 mm | 3/8" | x4
- x4
- x2

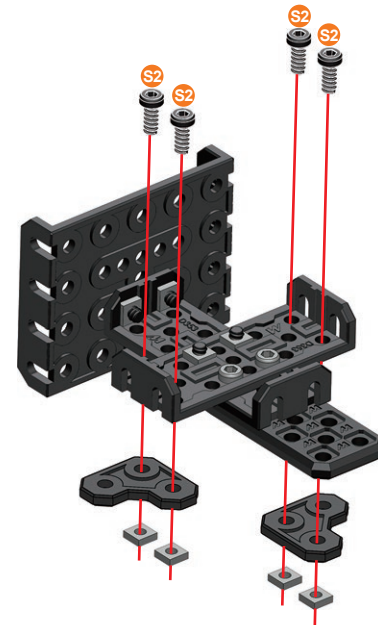
- S2 | 1:1





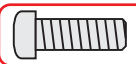

4

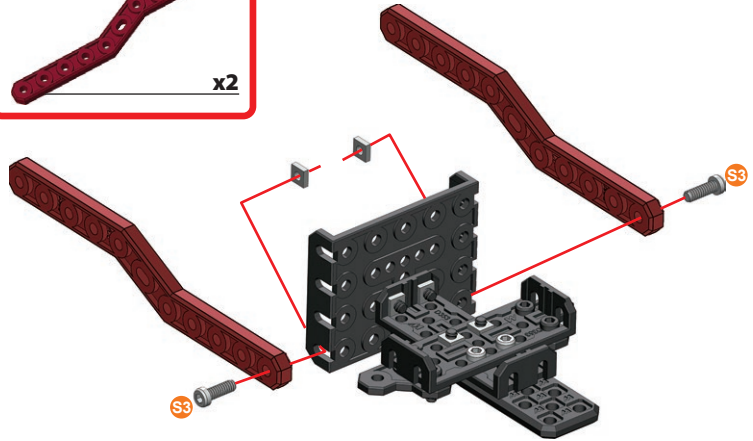

	12 mm 1/2"	x2
		x2

	1:1
---	-----







5

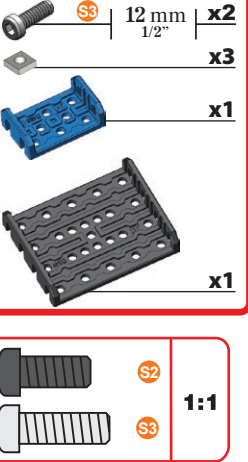
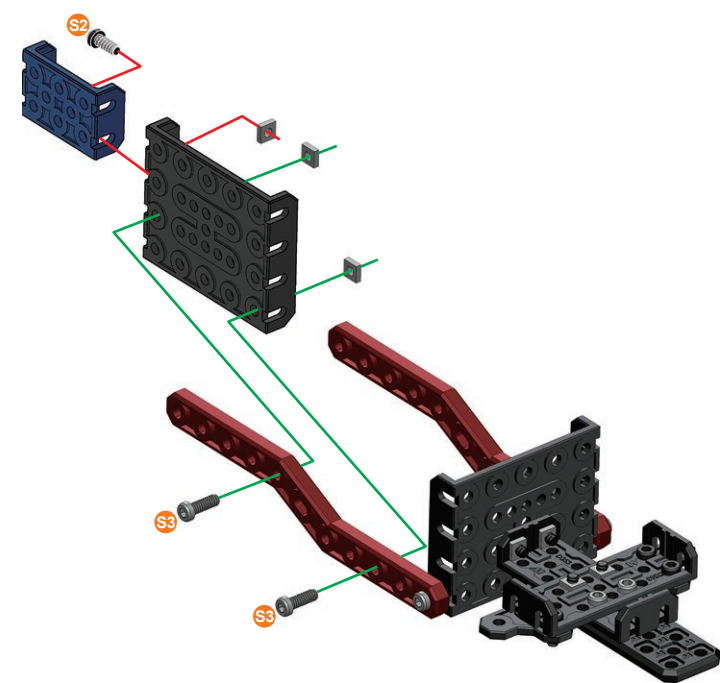

	9,5 mm 3/8"	x1
	12 mm 1/2"	x2
		x3
		x1
		x1

	S2	1:1
	S3	



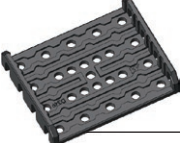

6

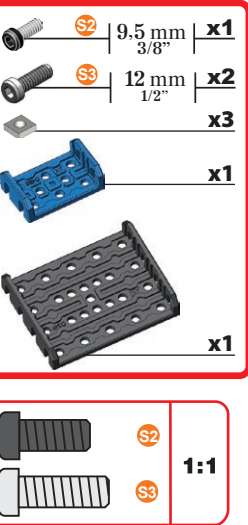

	9,5 mm 3/8"	x1
	12 mm 1/2"	x2
		x3
		x1
		x1

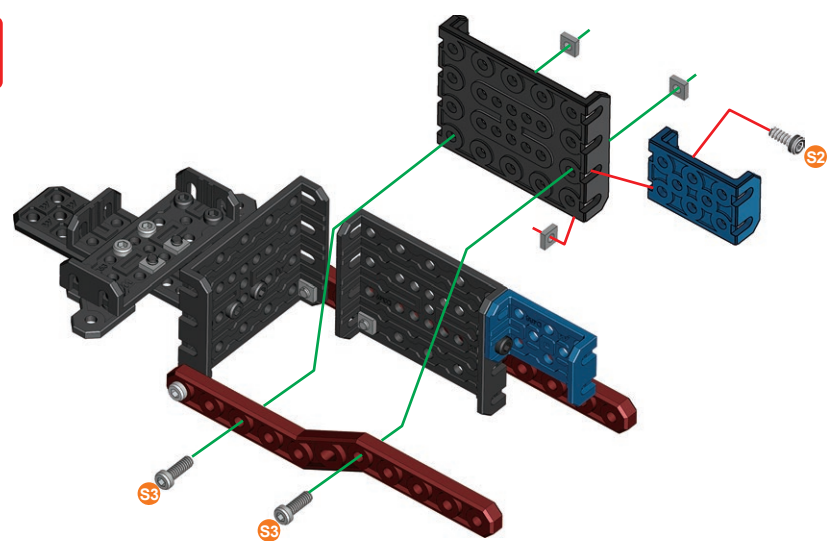
	S2	1:1
	S3	







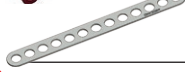

7

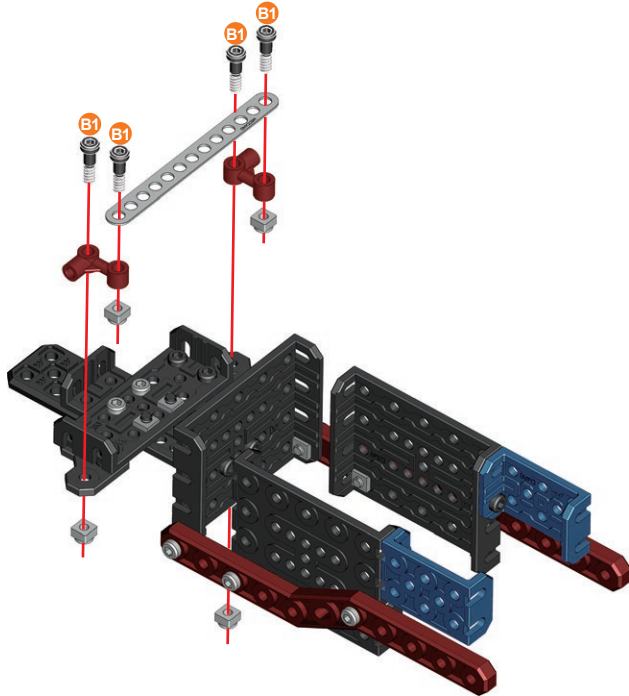
-  **B1** | 14.7 mm | **x4**
37/64"
-  **x4**
-  **x2**
-  **x1**

-  **B1** | **1:1**





8

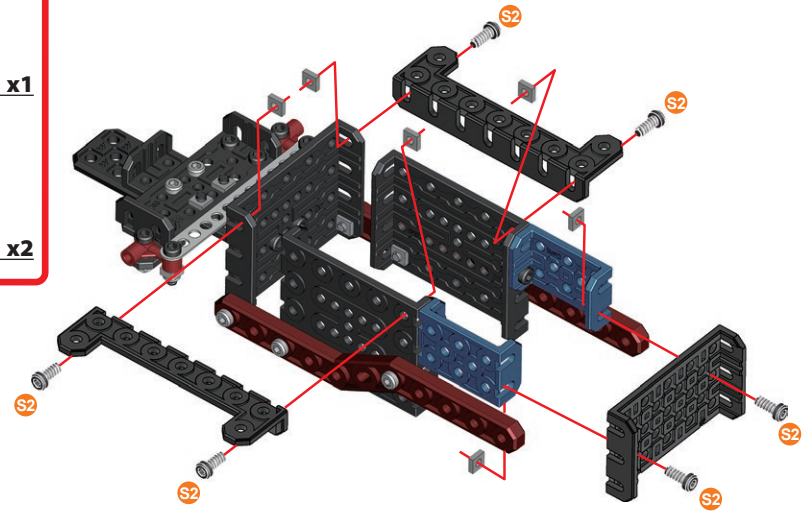

-  **S2** | 9.5 mm | **x6**
3/8"
-  **x6**
-  **x1**
-  **x2**

-  **S2** | **1:1**



9

-  **S2** | 9.5 mm | **x2**
3/8"
-  **S3** | 12 mm | **x2**
1/2"
-  **x4**
-  **x2**
-  **x2**

-  **S2**
-  **S3** | **1:1**

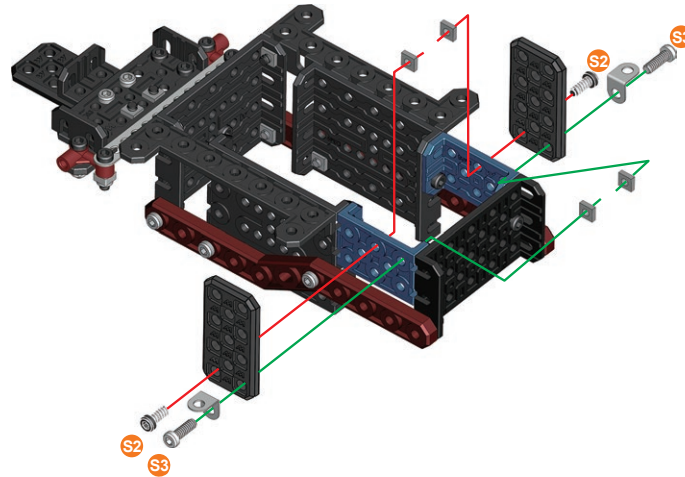



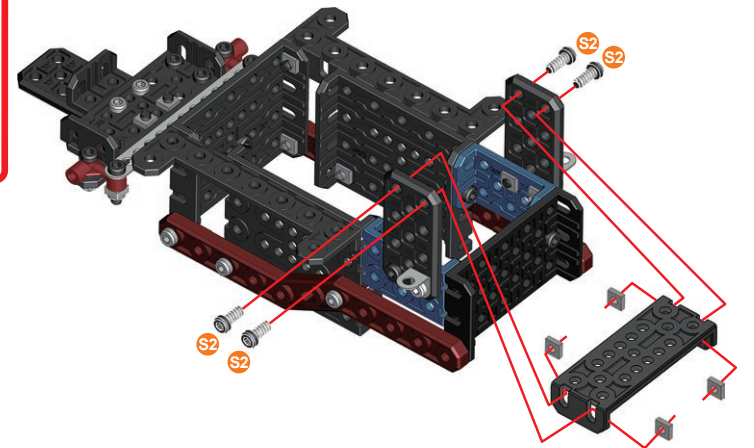

10

-  **S2** | 9.5 mm | **x4**
3/8"
-  **x4**
-  **x1**



-  **S2** | **1:1**





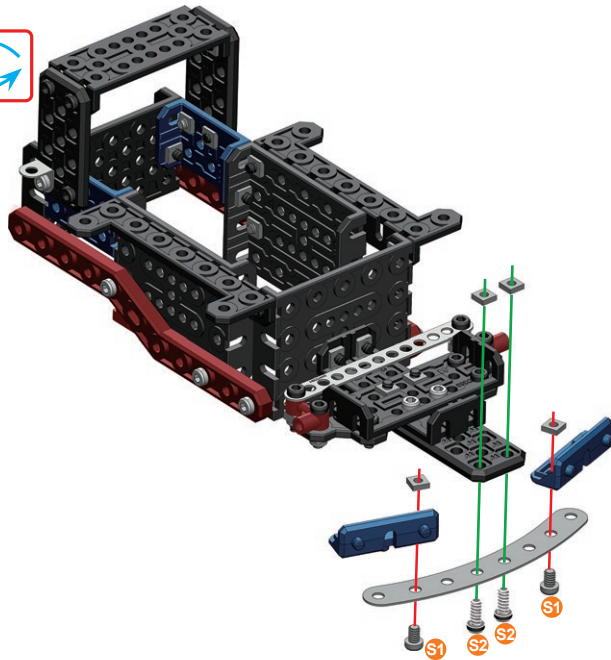

11

-  S1 | 5.8 mm | 15/64" | x2
-  S2 | 9.5 mm | 3/8" | x2
-  | x4
-  | x2
-  | x1



-  S1
-  S2
- 1:1







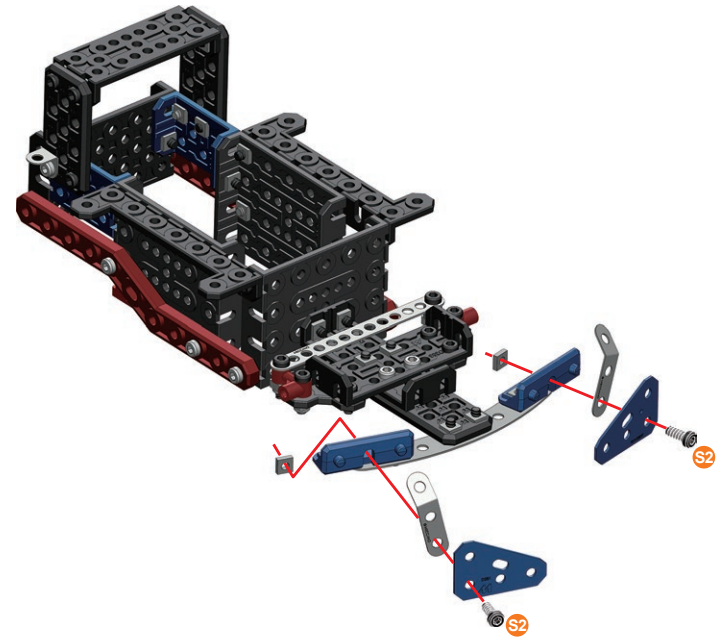

12



-  S2 | 9.5 mm | 3/8" | x2
-  | x2
-  | x2
-  | x2

-  S2
- 1:1





13

-  S1 | 5.8 mm | 15/64" | x2
-  S2 | 9.5 mm | 3/8" | x2
-  | x4
-  D1 | 11.25mm | 7/16" | x2
-  | x2
-  | x1
-  | x2
-  | x1
-  | x1

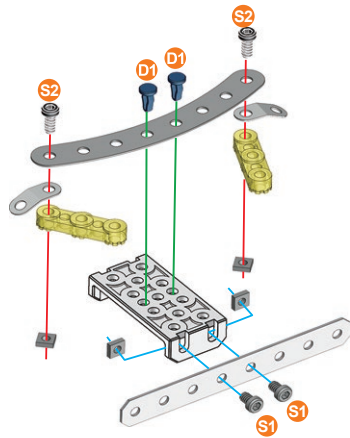
-  S1
-  S2
- 1:1
-  D1





14

-  D1 | 11.25mm | 7/16" | x2
-  | x2

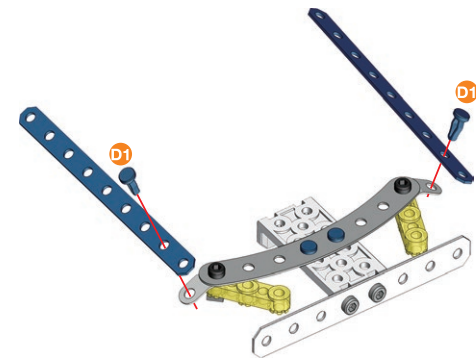



-  D1
- 1:1



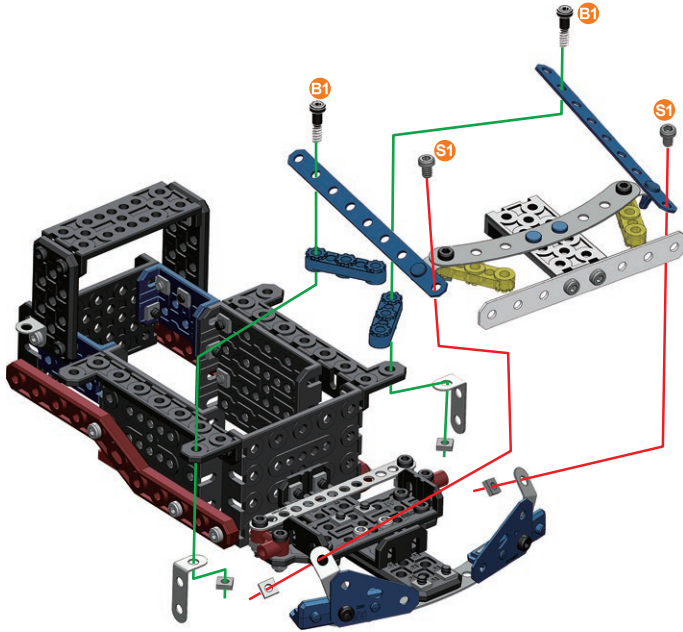

- 15** (12)+(14)+
- | | | |
|---|-------------------|----|
|  | 5.8 mm
15/64" | x2 |
|  | 14.7 mm
37/64" | x2 |
|  | | x4 |
|  | | x2 |
|  | | x2 |





- | | | |
|---|----|-----|
|  | S1 | 1:1 |
|  | B1 | |

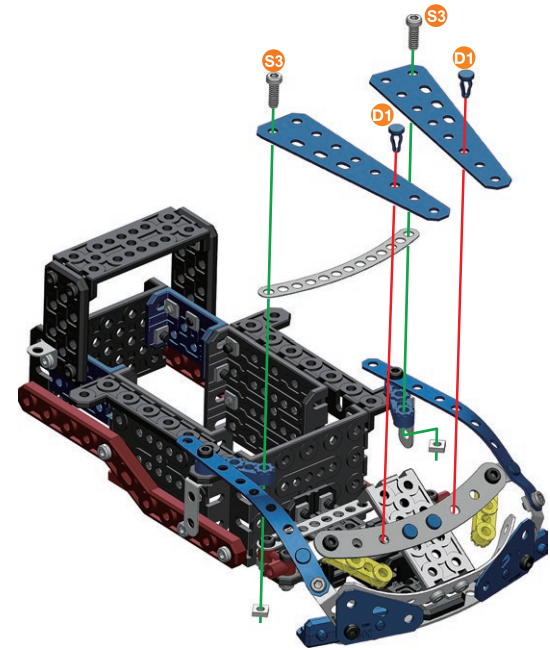

- 16**
- | | | |
|---|-------------------|----|
|  | 12 mm
1/2" | x2 |
|  | | x2 |
|  | 11.25 mm
7/16" | x2 |
|  | | x1 |
|  | | x2 |





- | | | |
|---|----|-----|
|  | S3 | 1:1 |
|  | D1 | |

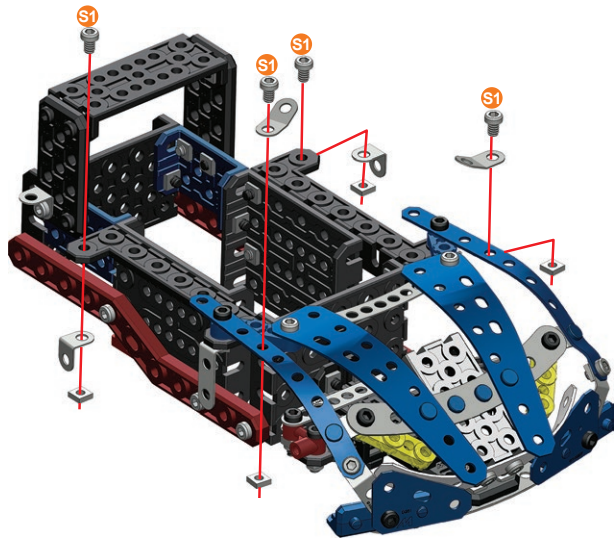

- 17**
- | | | |
|---|------------------|----|
|  | 5.8 mm
15/64" | x4 |
|  | | x4 |
|  | | x2 |
|  | | x2 |

- | | | |
|---|----|-----|
|  | S1 | 1:1 |
|---|----|-----|





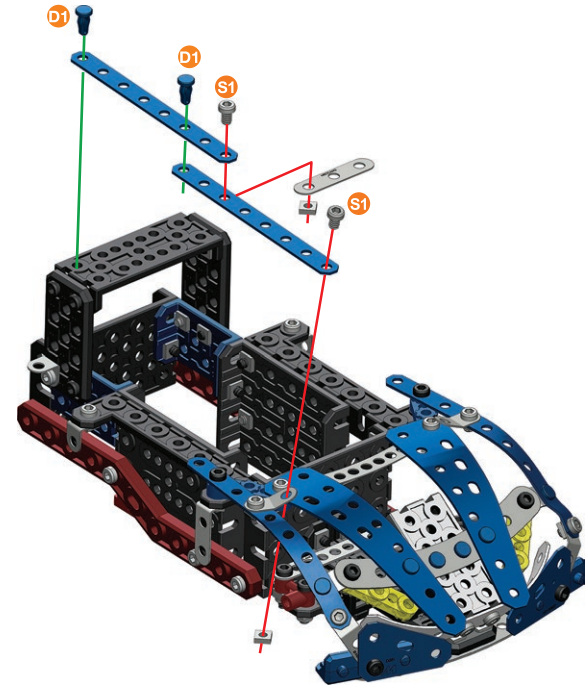

- 18**
- | | | |
|---|-------------------|----|
|  | 5.8 mm
15/64" | x2 |
|  | | x2 |
|  | 11.25 mm
7/16" | x2 |
|  | | x2 |
|  | | x1 |

- | | | |
|---|----|-----|
|  | S1 | 1:1 |
|  | D1 | |







19

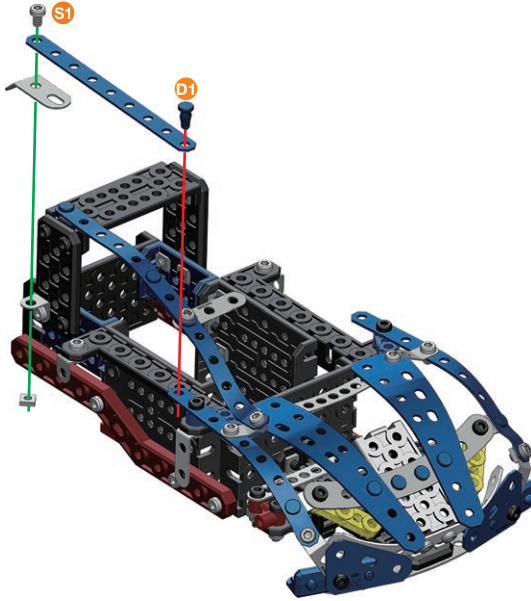

-  S1 | 5.8 mm | **x1**
15/64"
-  | **x1**
-  | **x1**
-  D1 | 11.25 mm | **x1**
7/16"
-  | **x1**

- | | | |
|---|----|------------|
|  | S1 | 1:1 |
|  | D1 | |



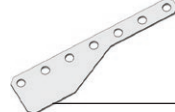

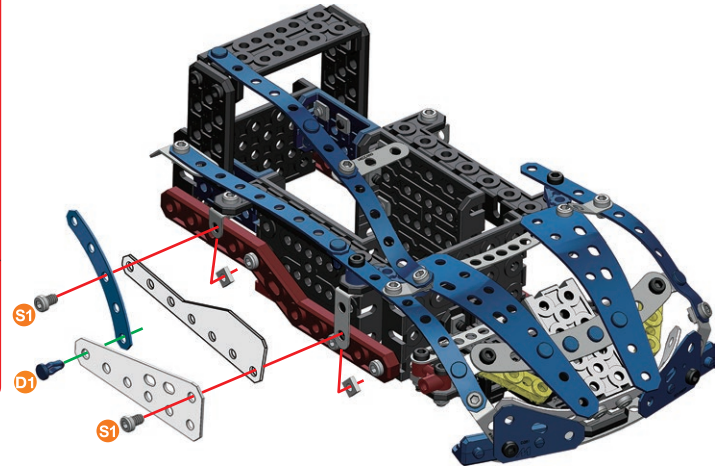

20

-  S1 | 5.8 mm | **x2**
15/64"
-  | **x2**
-  D1 | 11.25 mm | **x1**
7/16"
-  | **x1**
-  | **x1**
-  | **x1**

- | | | |
|---|----|------------|
|  | S1 | 1:1 |
|  | D1 | |

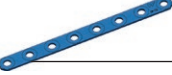

21





-  S1 | 5.8 mm | **x2**
15/64"
-  | **x2**
-  D1 | 11.25 mm | **x2**
7/16"
-  | **x2**
-  | **x1**

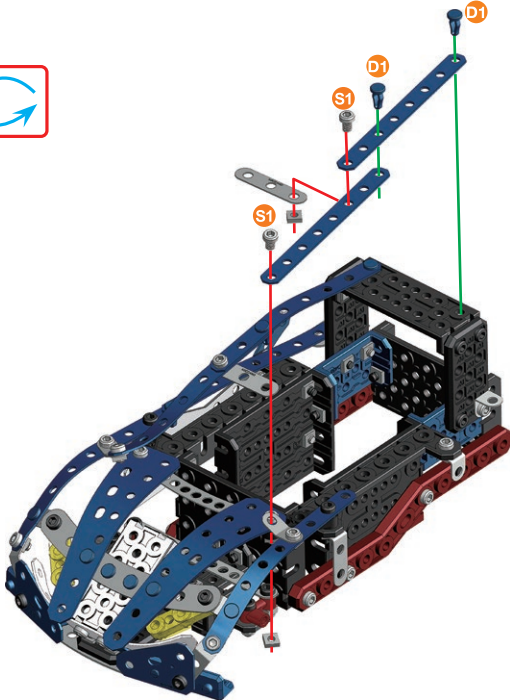

- | | | |
|---|----|------------|
|  | S1 | 1:1 |
|  | D1 | |

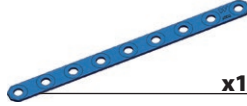

22

-  S1 | 5.8 mm | **x1**
15/64"
-  | **x1**
-  | **x1**
-  D1 | 11.25 mm | **x1**
7/16"
-  | **x1**

- | | | |
|---|----|------------|
|  | S1 | 1:1 |
|  | D1 | |

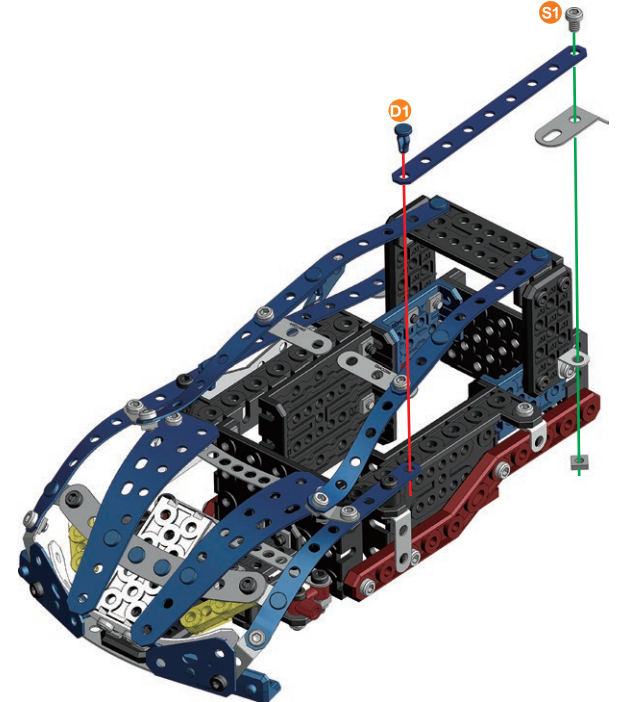

23

- S1 | 5.8 mm | 15/64" | x2
- | x2
- D1 | 11.25mm | 7/16" | x2
- | x1

- S1
- D1
- 1:1

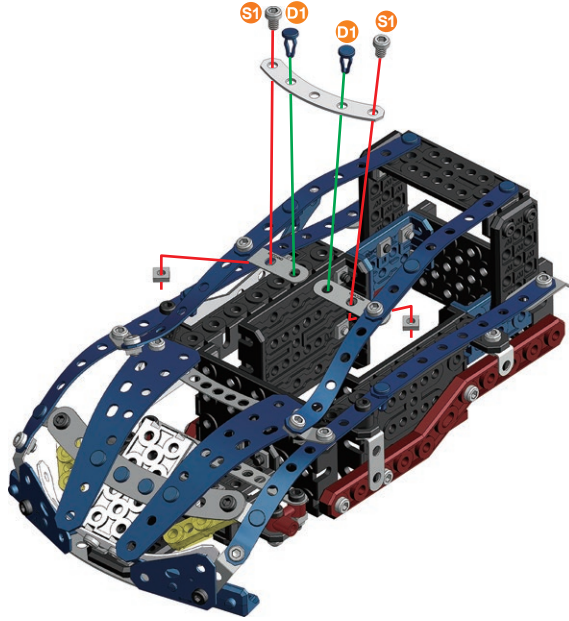

24

- S1 | 5.8 mm | 15/64" | x2
- | x2
- D1 | 11.25mm | 7/16" | x1
- | x1
- | x1
- | x1

- S1
- D1
- 1:1

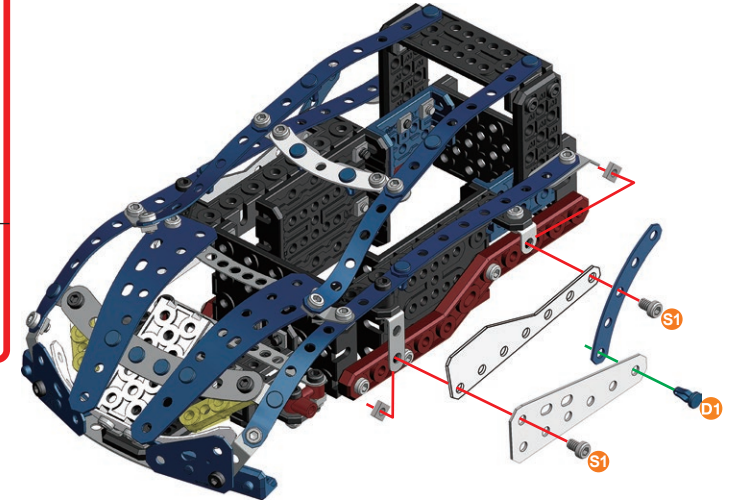

25

- S1 | 5.8 mm | 15/64" | x2
- | x2
- D1 | 11.25mm | 7/16" | x2
- | x2
- | x2

- S1
- D1
- 1:1

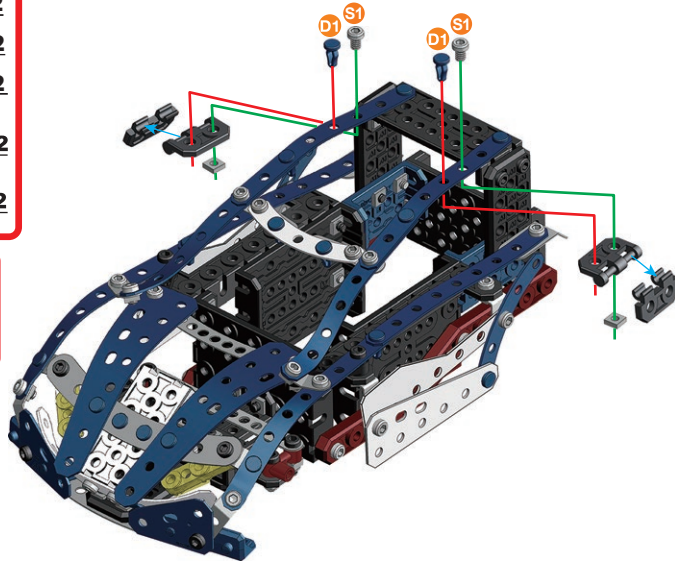



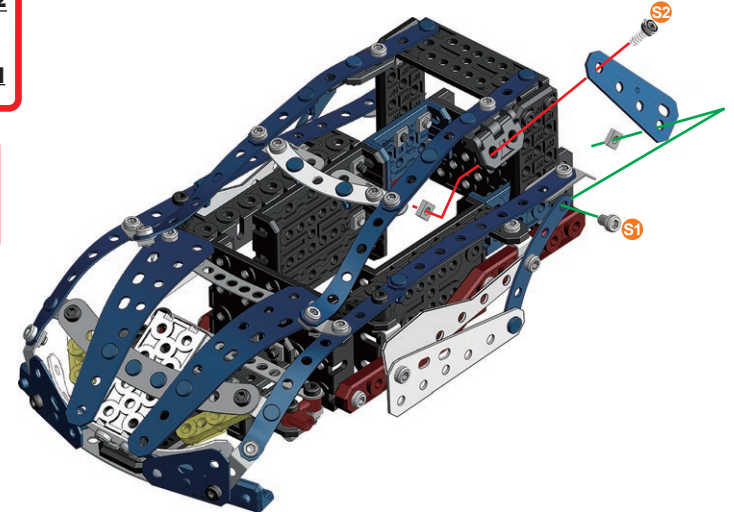

26

- S1 | 5.8 mm | 15/64" | x1
- S2 | 9.5 mm | 3/8" | x1
- | x2
- | x1



- S1
- S2
- 1:1

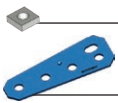

27

	5.8 mm 15/64"	x1
	9.5 mm 3/8"	x1
		x1
		x2



	S1	1:1
	S2	

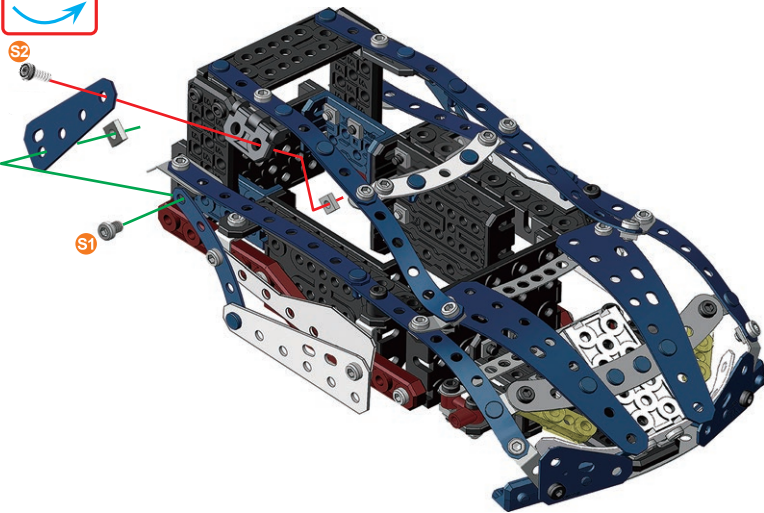

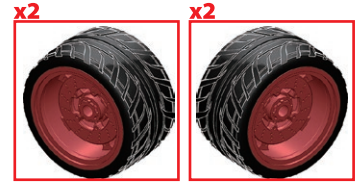

28

	x4
	x4



29



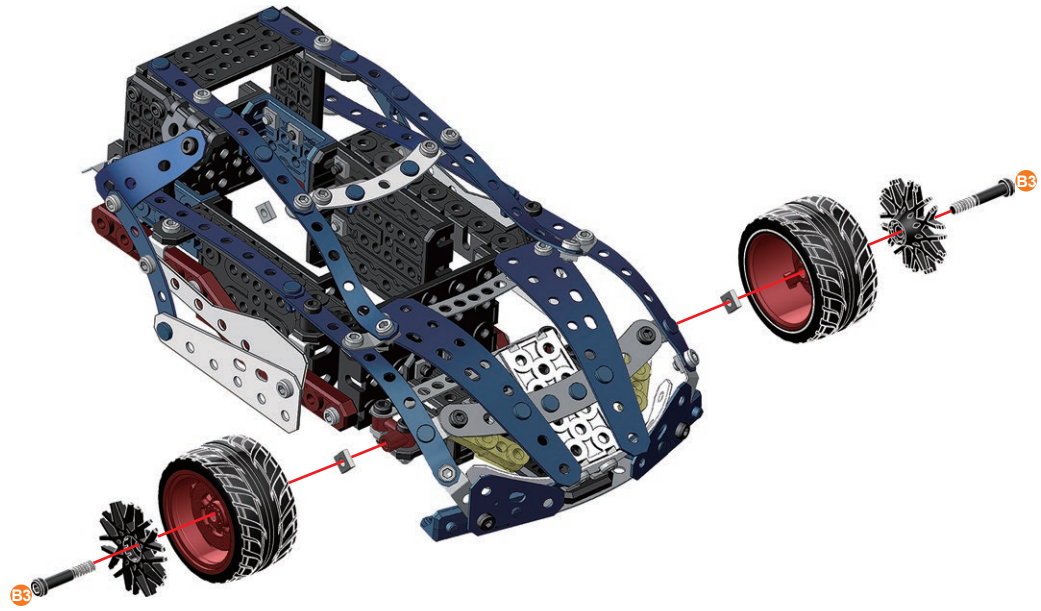

(27)+(28)+

	23 mm 15/16"	x2
		x2
		x2

	B3	1:1
---	----	-----



30

-  9.5 mm | 3/8" | **x4**
-  **x4**
-  **x2**
-  **x1**





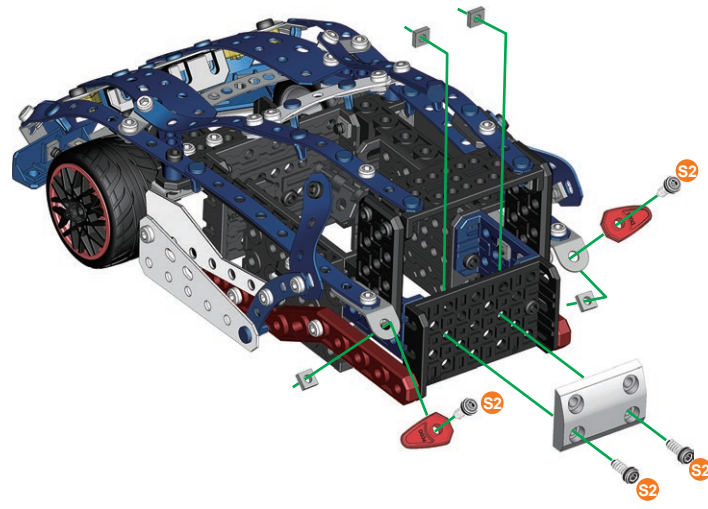

-  **1:1**



31

28+30+

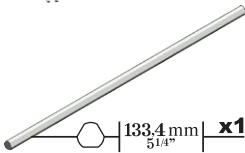
-  **x2**
-  **x2**
-  **x2**
-  **x2**
-  133.4 mm | 5 1/4" | **x1**

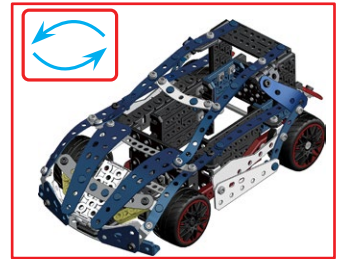

-   **A238** **1:1**

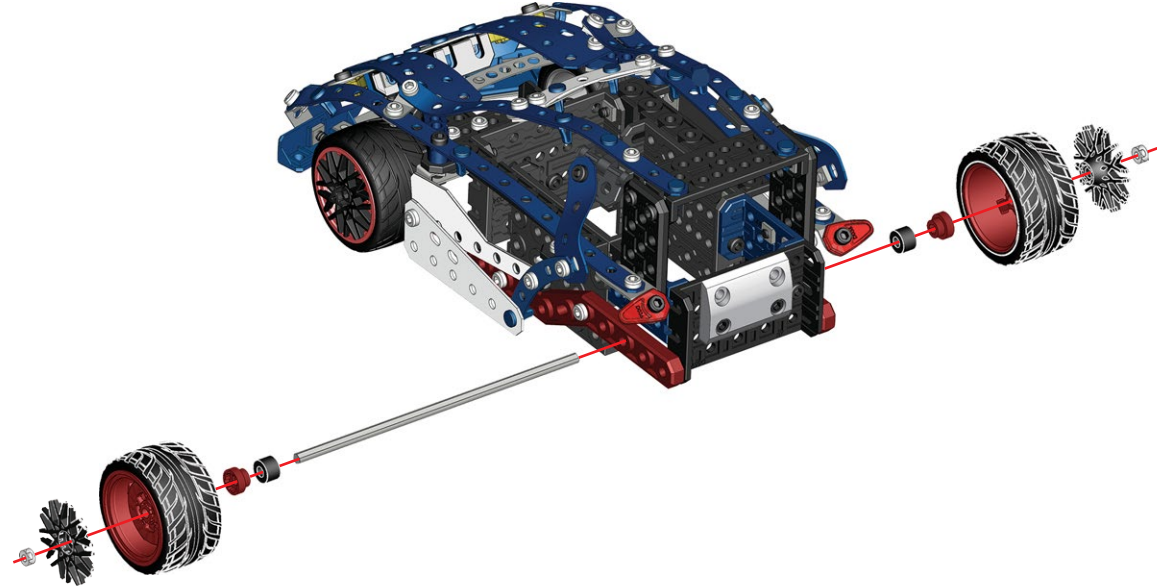

-  **1:1**