

**CITY**

**#5890**



 **5-8**

 **WARNING : CHOKING HAZARD**  
Small parts. Not for children under 3 years.

**GB** With Meccano Junior and Erector Play System™ your child will have great fun learning how to build both with instructions and their own imagination. They will develop important motor skills using the nuts and bolts construction system, improve sorting, counting and concentration skills.

**USA**

**F** Avec Meccano Junior, votre enfant ne va pas seulement s'amuser, créer, exercer son imagination, il va aussi apprendre à construire, affiner sa grapho-motricité en vissant, s'exercer à compter, trier des pièces, apprendre à se concentrer, à suivre un plan, à s'organiser.

**D** Mit Meccano Junior wird Ihr Kind nicht nur Spaß haben, kreativ sein und seine Phantasie erweitern, sondern es wird auch lernen, Modelle zu bauen und durch das Schrauben seine Feinmotorik zu verbessern. Es übt sich im Zählen, lernt richtige Bauteile auszuwählen, sich zu konzentrieren und zu organisieren, sowie einer Bauanleitung zu folgen.

Meccano Junior begleitet und stimuliert somit die psychologische (Phantasie, Kreativität und Ausdauer) und motorische (Geschicklichkeit, Genauigkeit) Entwicklung Ihres Kindes.

**I** Con Meccano Junior i vostri bambini potranno non solo divertirsi, creare ed esercitare la propria immaginazione, ma anche imparare a costruire, sviluppare capacità motorie e logiche, esercitarsi a contare, a scegliere i pezzi.

Impareranno inoltre a concentrarsi, a seguire un piano, ad organizzarsi.

**E** Con Meccano Junior, vuestro hijo no va únicamente a divertirse, crear, ejercitar su imaginación, también aprenderá a construir, a contar, a escoger piezas, a concentrarse, seguir instrucciones, a organizarse y además afinará su psicomotricidad.

**P** Com Meccano Junior, o vosso filho não só se vai divertir, criar, exercitar a imaginação, mas também aprenderá a construir, a contar, a escolher peças, a concentrar-se, a seguir instruções, a organizar-se e, além disso, afinará a sua psicomotricidade.

**S** Med Meccano Junior kommer ditt barn att få mycket roligt, genom att både lära sig att bygga efter en instruktion och med hjälp av den egna fantasin.

Barnet utvecklar motoriken genom att använda muttrar och skruvar, vidareutvecklar färdigheter såsom sortering, räkning och koncentrationsförmågan.

**FIN** Meccano Junior sarjan avulla lapsella on hauskaa oppiessaan rakentamaan sekä ohjeiden mukaan että omaa mielikuvitustaan käyttäen.

Tärkeät motoriset taidot kehittyvät, kun tutustutaan rakennussarjan ruuveihin ja muttereihin, ja lajittelu-, laskenta- ja keskittymistaidot paranevat.

**DK** Med Meccano Junior vil dit barn have meget sjov ud af at lære at bygge, både med hjælp fra instruktionerne og af egen fantasi.

Børn udvikler vigtige motoriske evner ved at bruge konstruktionssystemet med møtrikker og bolte. De bliver bedre til at sortere de forskellige dele, samt til at tælle, koncentrere sig, følge en plan og organisere sig.

**NL** Met Meccano Junior leert uw kind met veel plezier te bouwen met behulp van de instructies en zijn/haar eigen fantasie.

Door het bouten-en-moeren-constructiesysteem te gebruiken, ontwikkelen en verbeteren ze belangrijke vaardigheden zoals sorteren, tellen en concentreren.

**GR** Με το Meccano Junior, το παιδί σας όχι μόνον θα διασκεδάσει, δημιουργήσει, εξασκήσει τη φαντασία του, θα μάθει επίσης να κατασκευάζει, εκλεπτύνει τις δυνατότητές του γραφής βιδώνοντας, θα ξασκηθεί στο μέτρημα, διαλογή τεμαχίων, θα μάθει να συγκεντρώνεται, να ακολουθεί ένα σχέδιο, να οργανώνεται.

**JPN** 皆さまのお子様はMeccano Juniorで、説明書に従った、または想像力を働かせた組立てを楽しみ、それと同時にボルトとナットを使ったセットの組立てで、器用さ、数の計算、分類、そして集中能力を養います。

 5-8





Follow the instructions and select parts.  
Suis la notice et choisis tes pièces.  
Folge der Bauanleitung und wähle die richtigen Teile aus.  
Segui le istruzioni e scegli i pezzi.

Sigue las instrucciones y escoge tus piezas.  
Segue as instruções e escolhe as tuas peças.  
Följ instruktionerna och välj rätt delar.  
Seuraa ohjeita ja valitse oikeat osat.

Følg instruktionerne og vælg de dele du skal bruge.  
Volg de instructies en zoek de juiste onderdelen uit.  
Ακολουθήσε τις οδηγίες και διάλεξε τα κομμάτια  
組立て説明書の通りに部品を選ぼう



Use tools to build.  
Construis avec tes outils.  
Bau mit Hilfe Deiner Werkzeuge.  
Utilizza gli attrezzi per costruire.

Utiliza las herramientas para montar.  
Utiliza as ferramentas para construir.  
Använd verktygen när du bygger.  
Käytä työkaluja rakentamiseen.

Brug dit værktøj til at bygge med.  
Gebruik je gereedschap bij het bouwen.  
Κατασκεύασε με τα εργαλεία  
道具で組立てよう

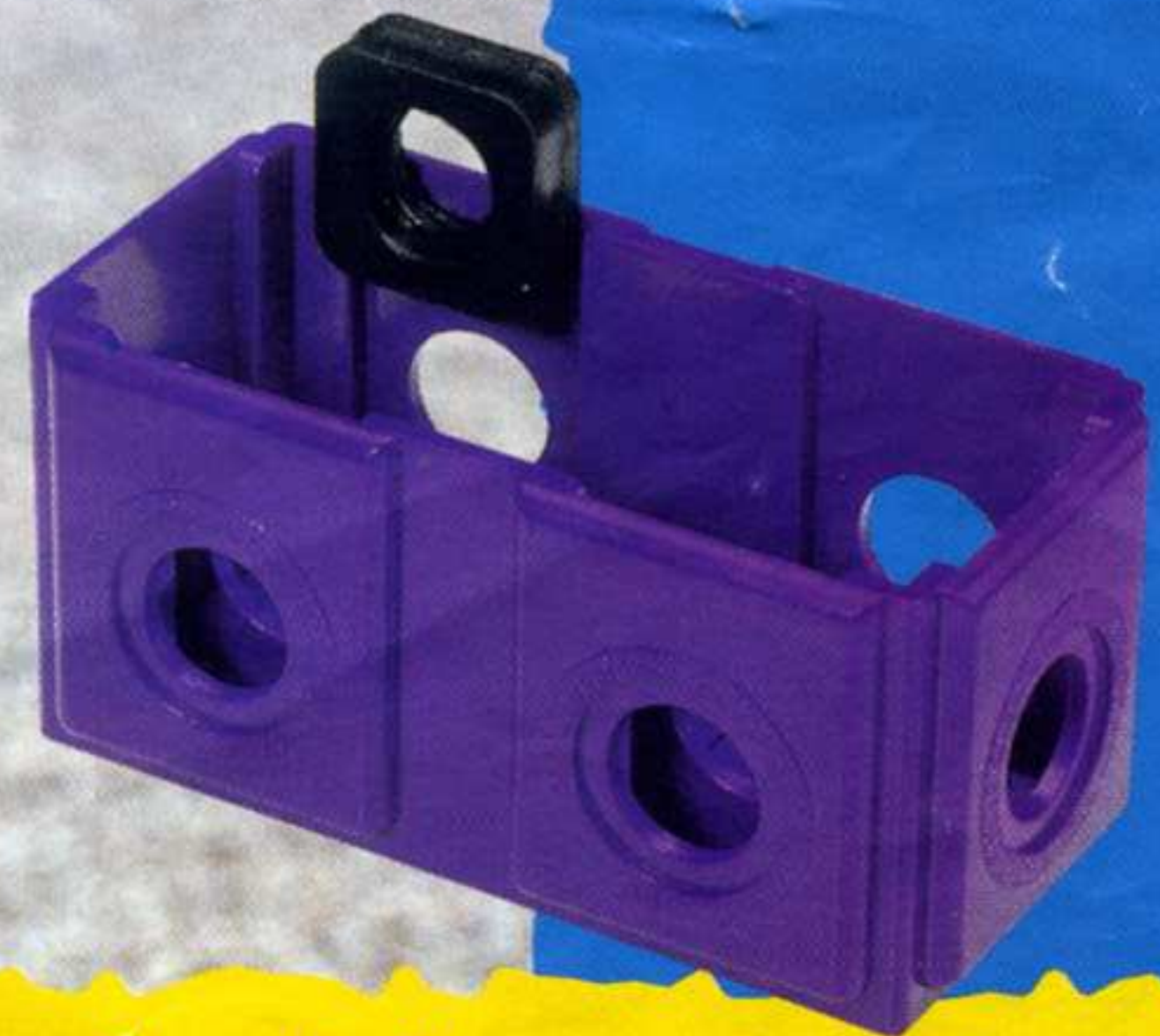
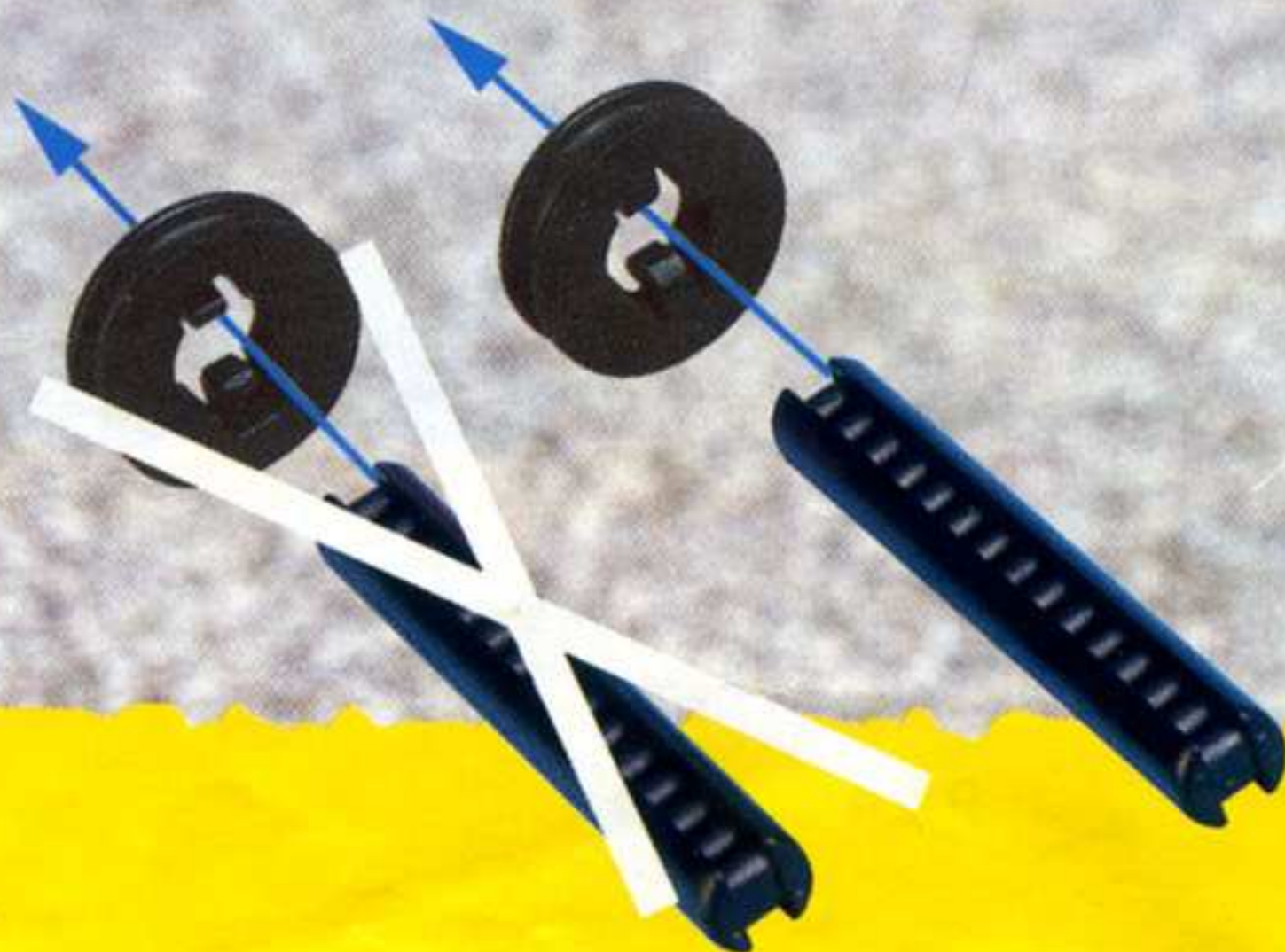

Slide in the nut  
Place l'écrou  
Plaziere die Mutter  
Posiziona il dado.

Coloca el tornillo.  
Coloca a porca.  
Sätt i muttern.  
Pujota mutteri sisään.

Sæt møtrikken i.  
Schuif de moer erin.  
Τοποθέτησε το παξιμάδι  
ナットを付けよう

INDEX  
INDEX  
ÜBERSICHT

ÍNDICE  
ÍNDICE  
ÍNDICE

INNEHÅLLSFÖRTECKNING  
SISÄLLYS  
INDHOLDSFORTEGNELSE

INDEX  
EYPETHPIO  
索引



P 5



P 10



P 16



P 26



P 5



P 10



P 18



P 30



P 6



P 12



P 20



P 32



P 8



P 14



P 22



P 36



P 8



P 14



P 24



P 38

20

TOYS  
JOUETS  
TOYS

GIOCATTOLI  
JUGUETES  
BRINQUEDOS

LEKSAKER  
LELUT  
FLERE STYKKER LEGETØJ

CONSTRUCTIES  
ΠΑΙΧΝΙΔΙΑ  
おもちゃ

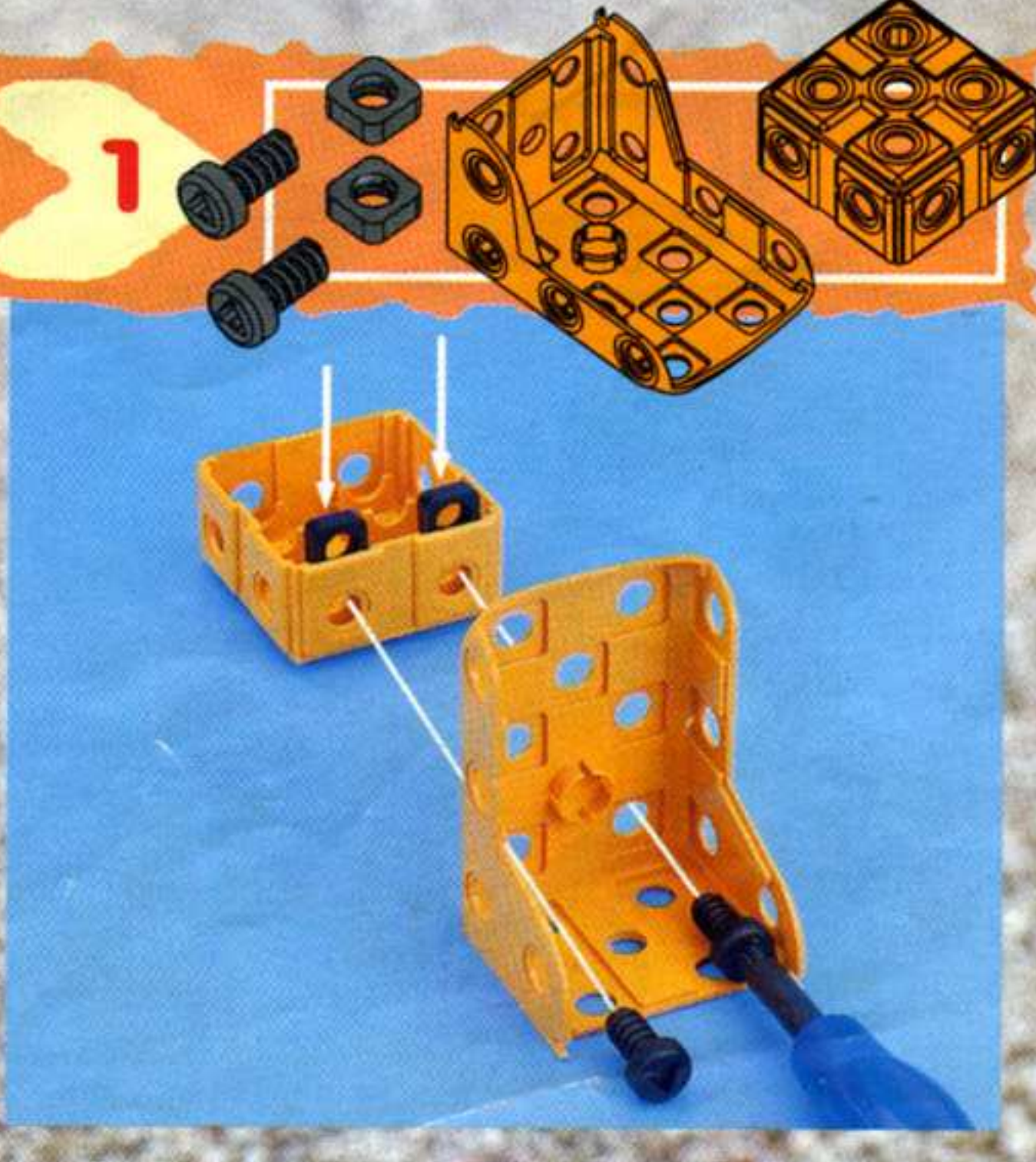
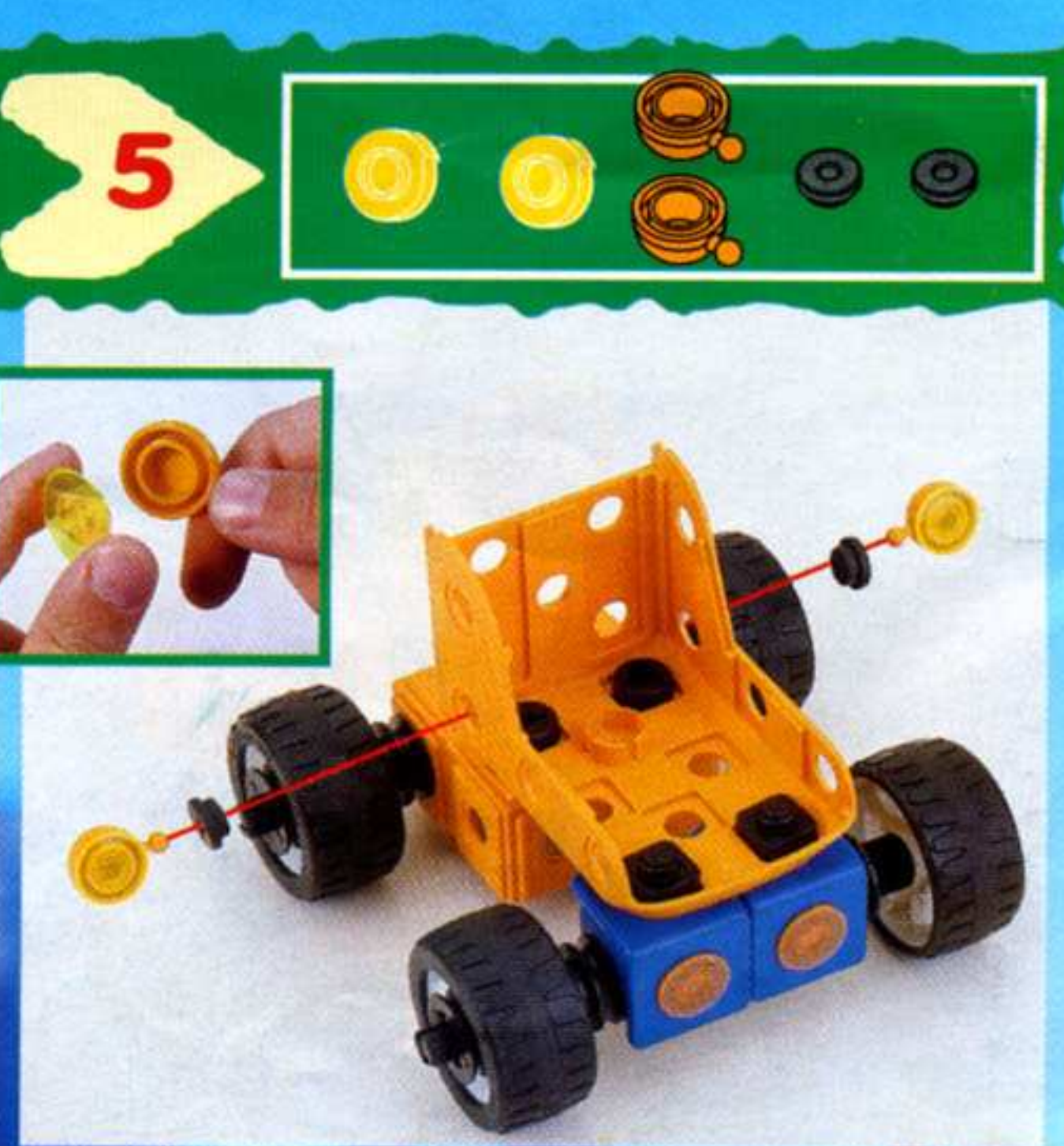
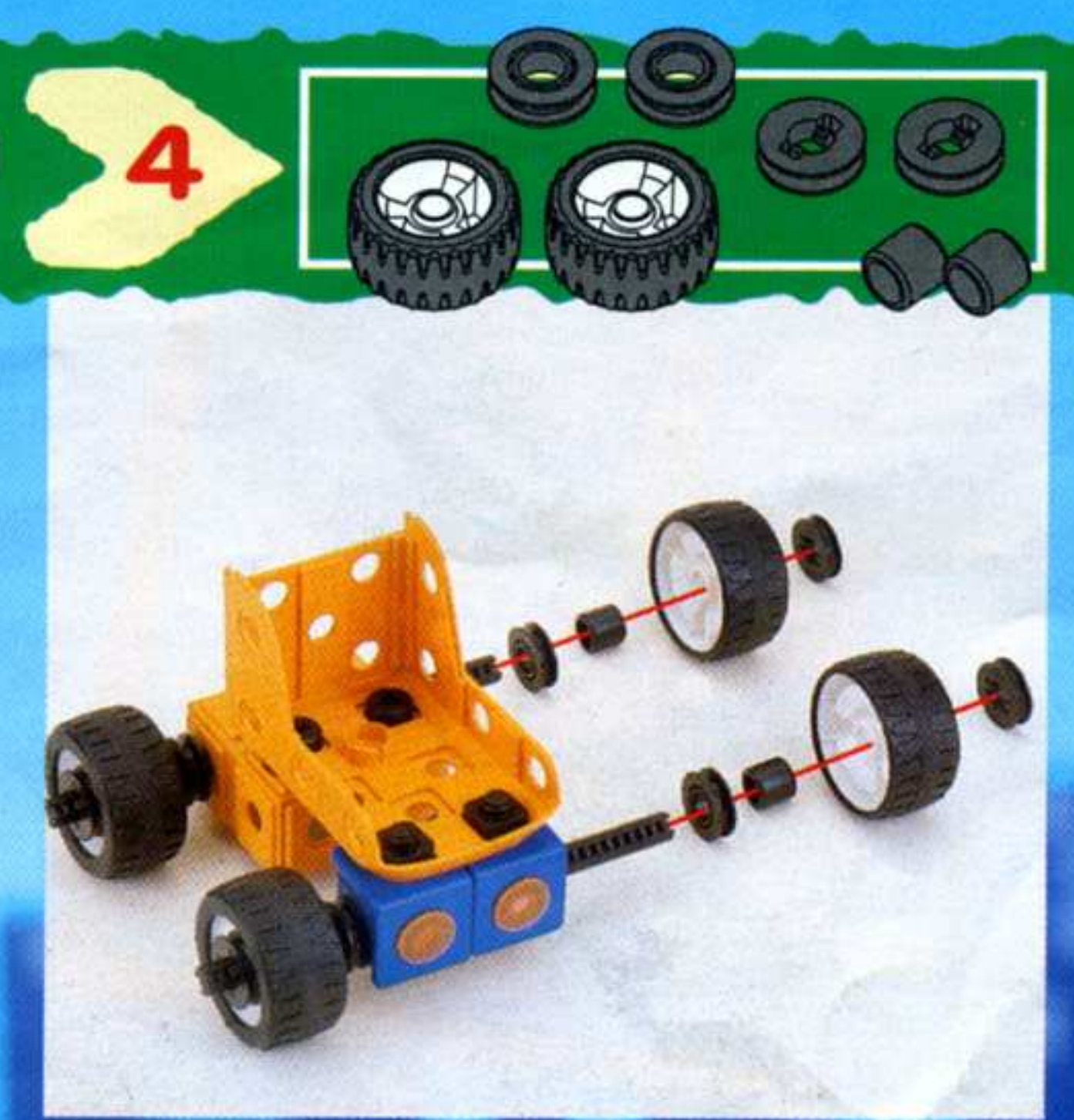

2



3



4

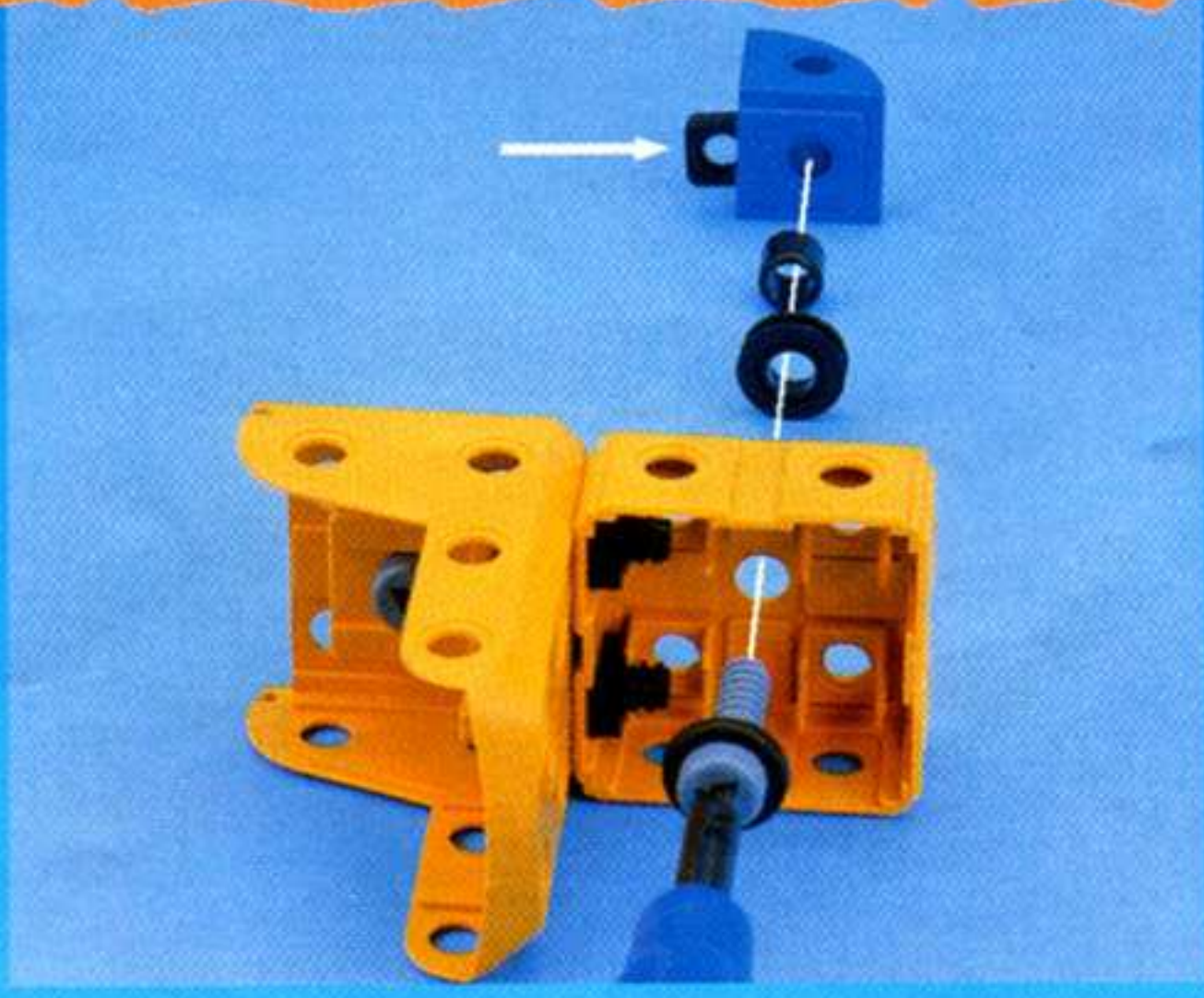
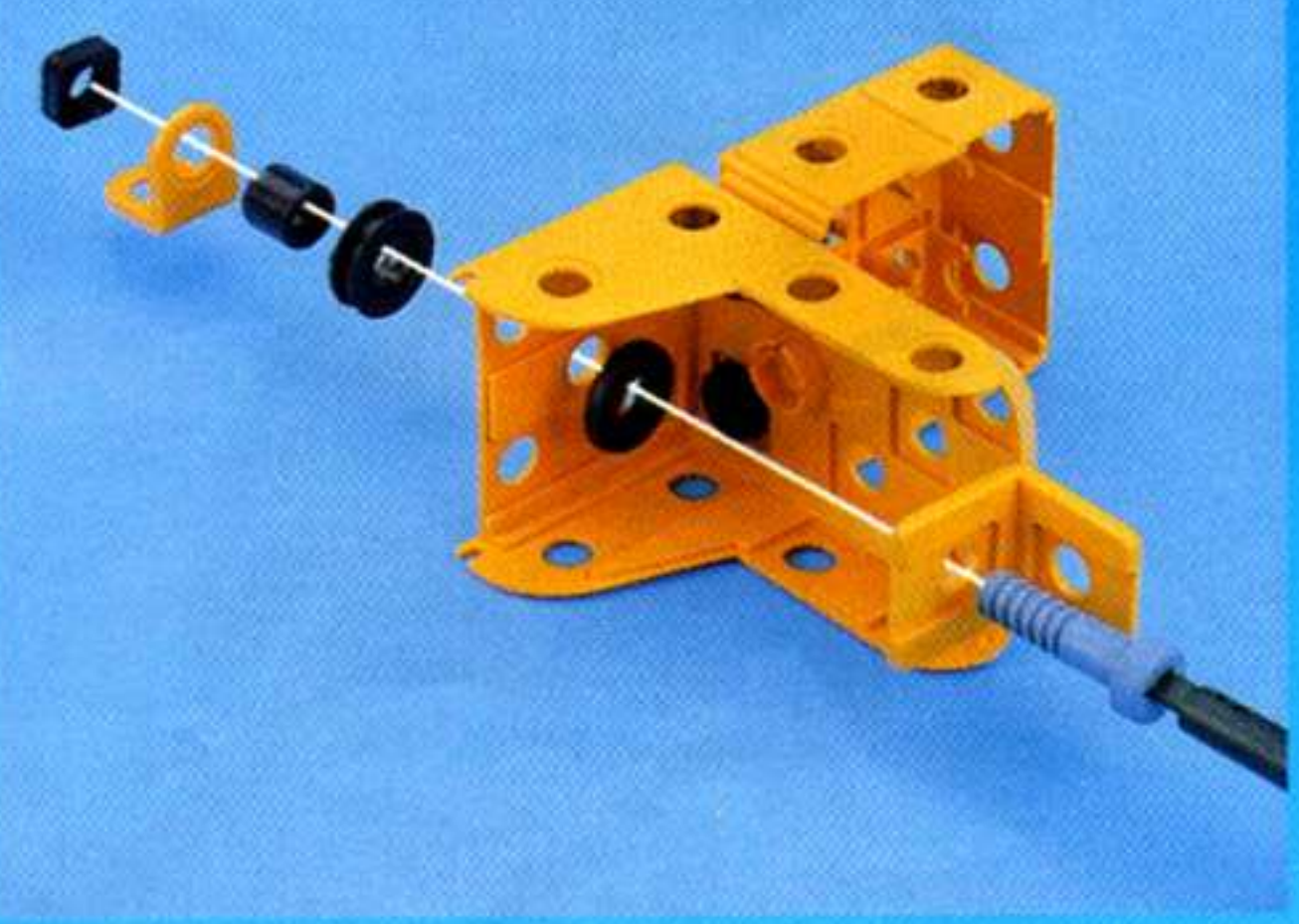

8



1

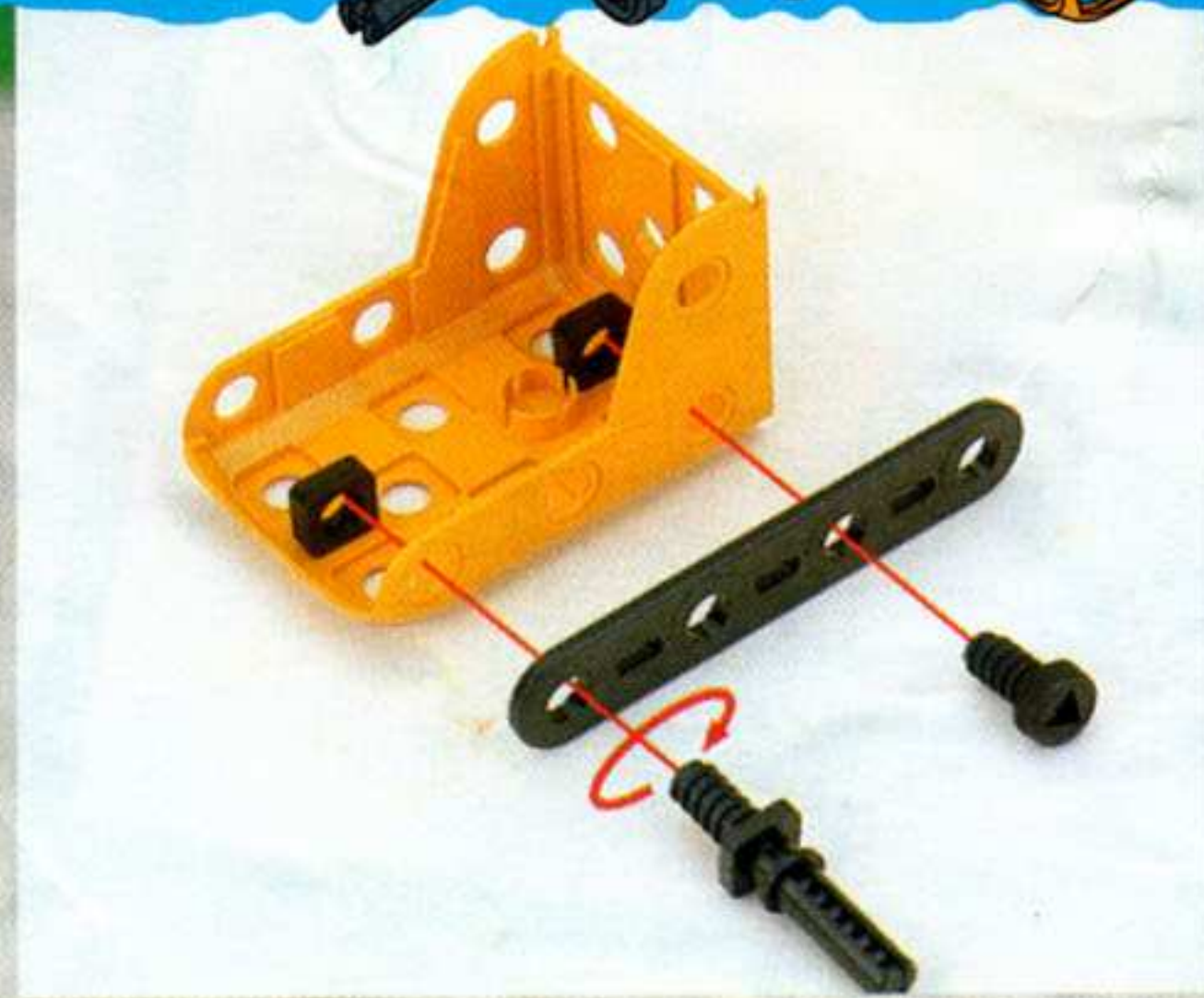

2



6



6

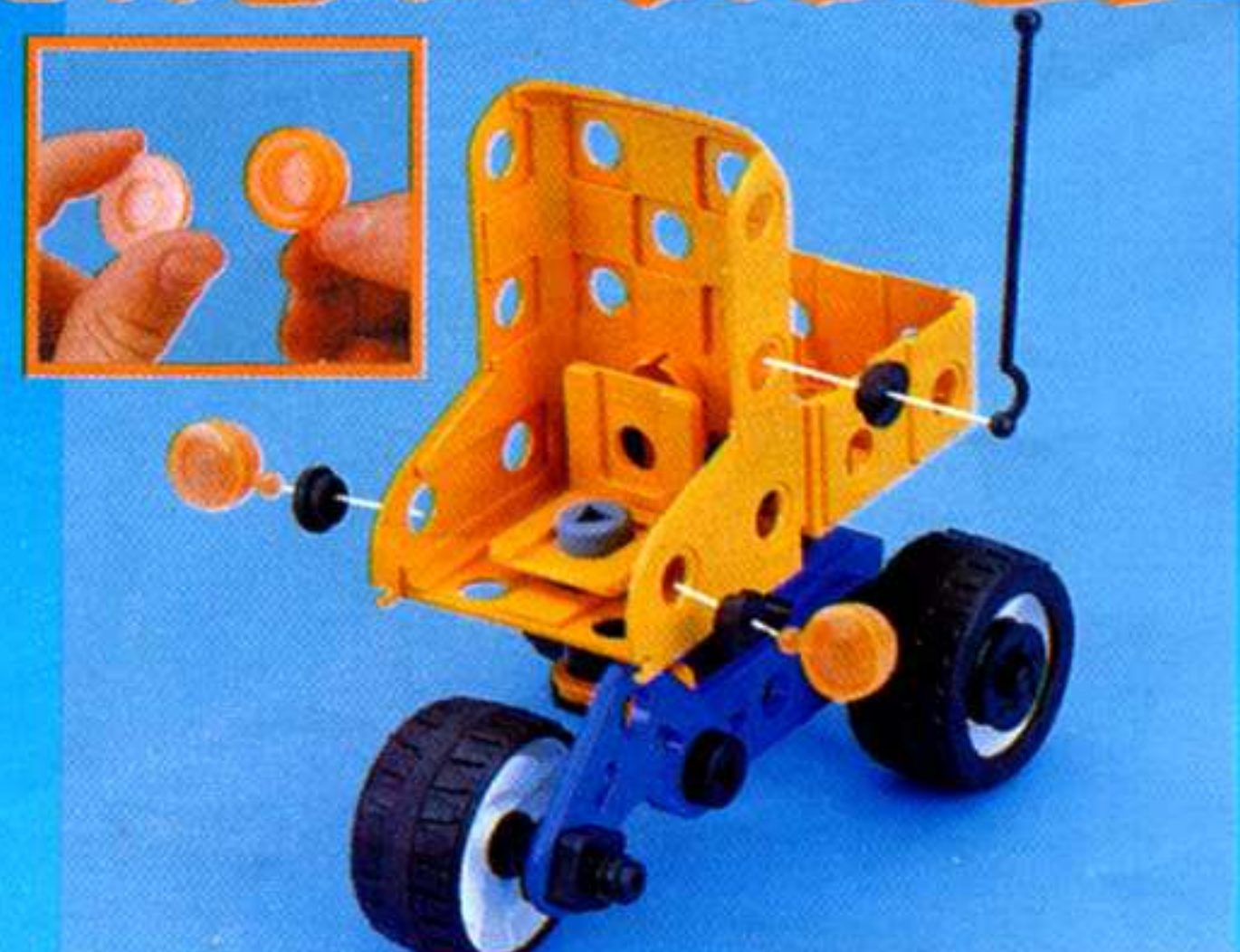
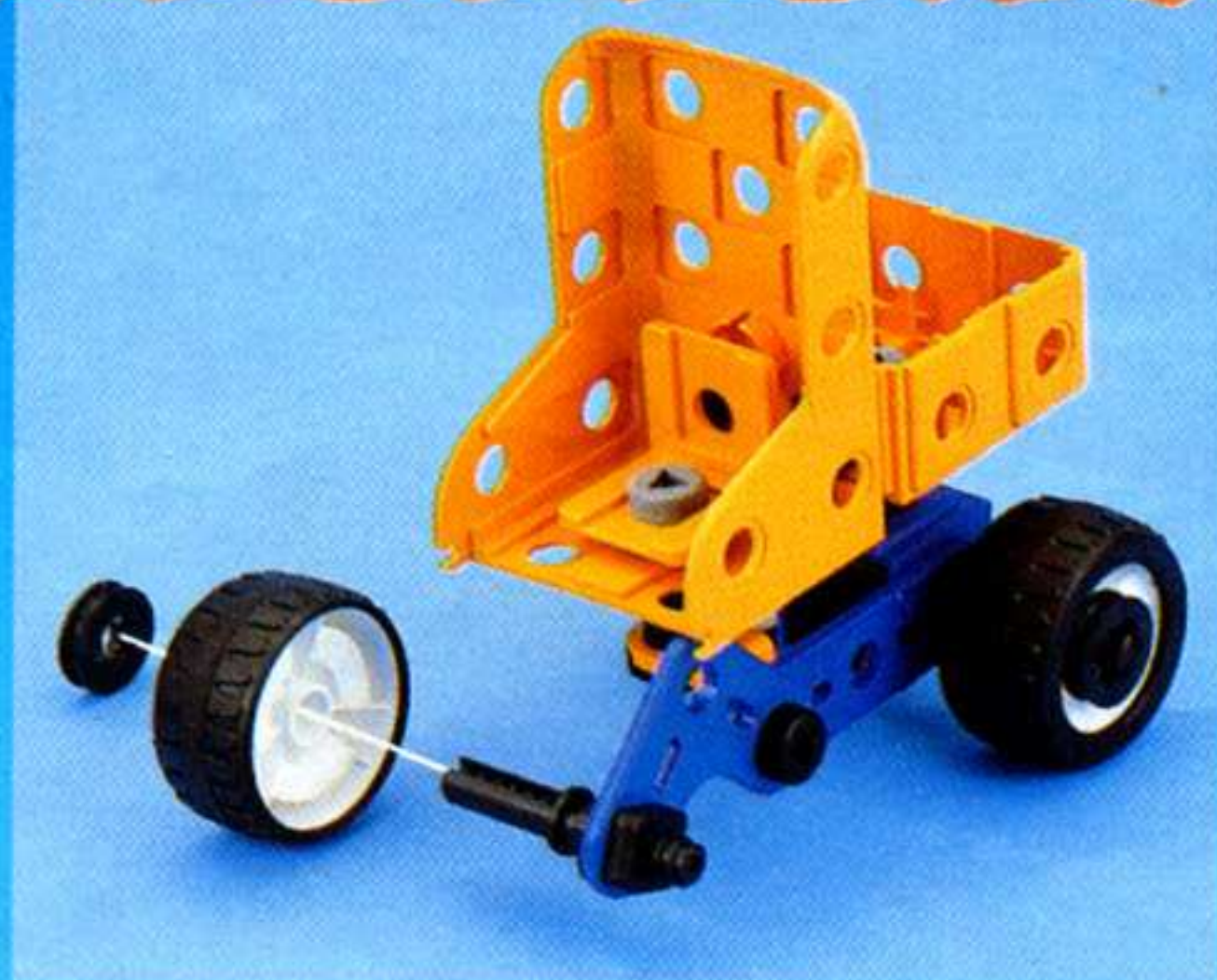
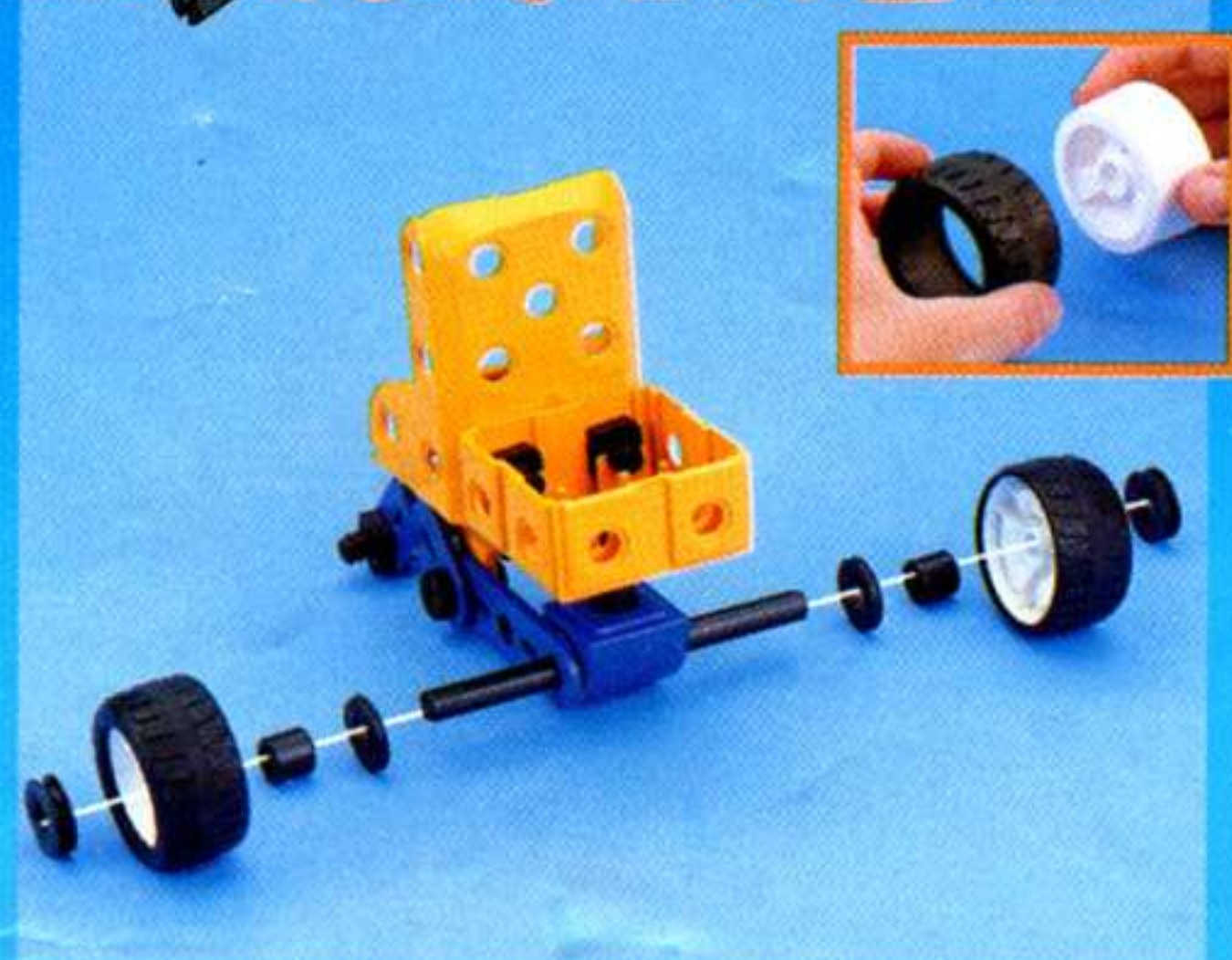

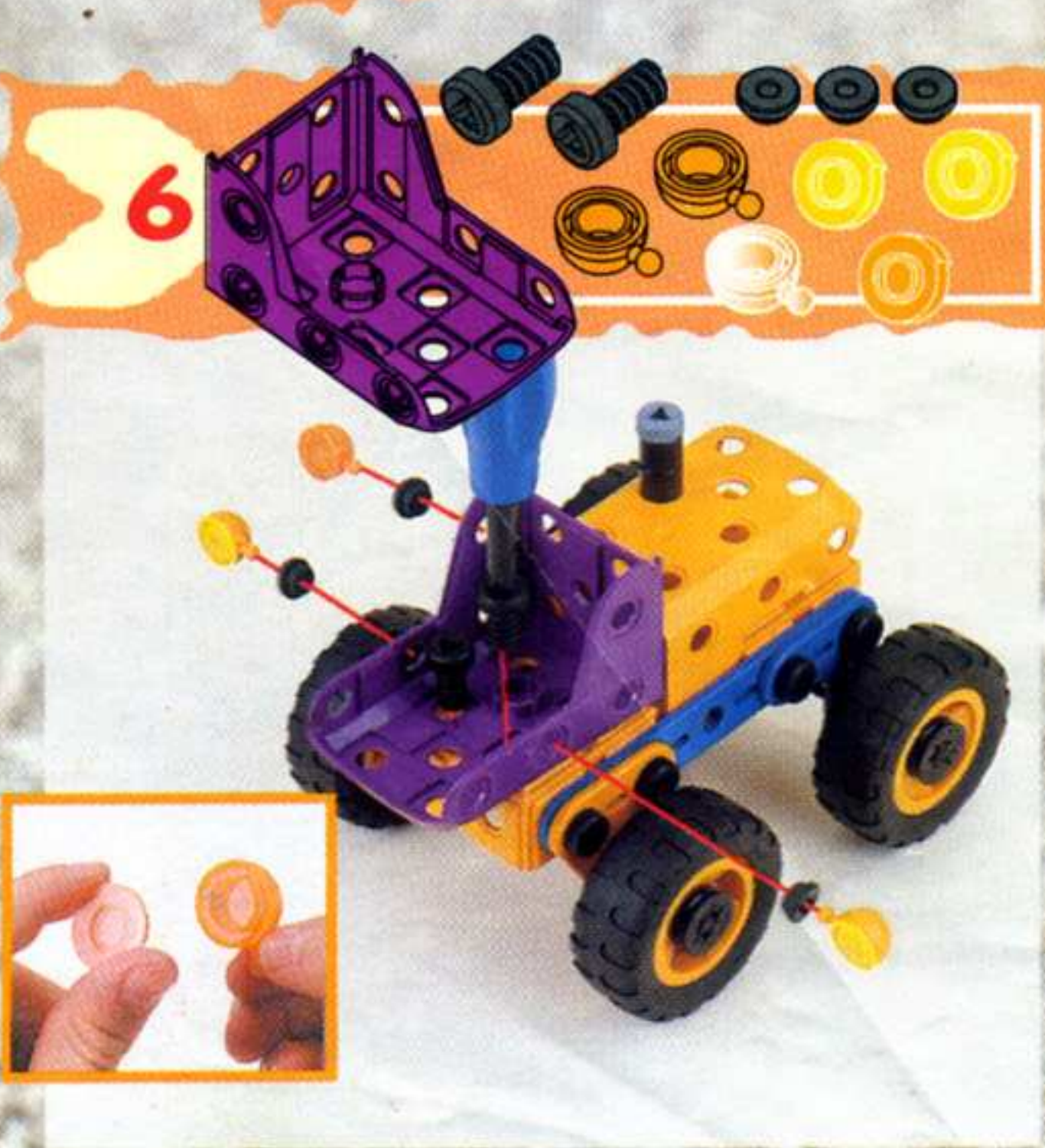
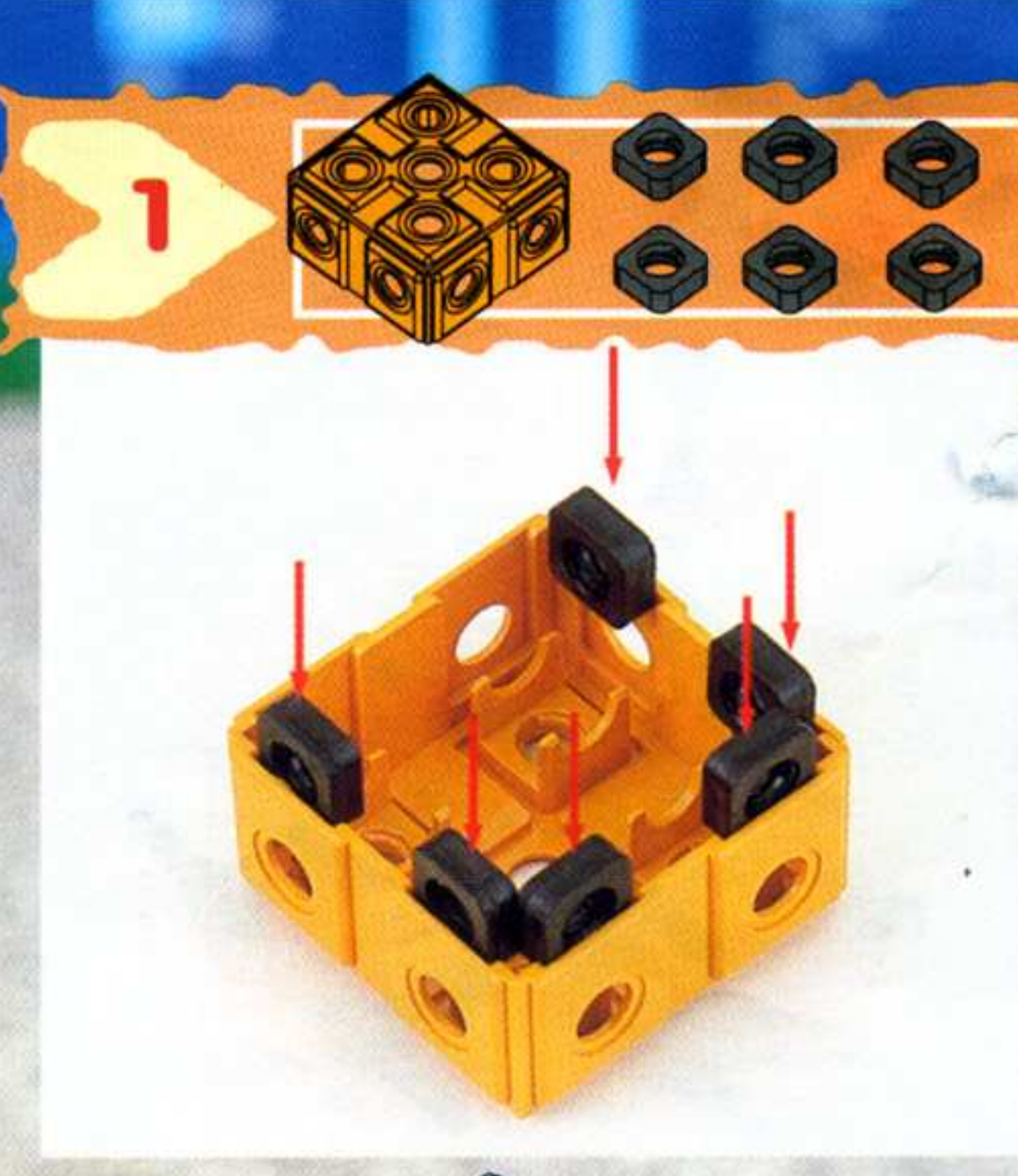
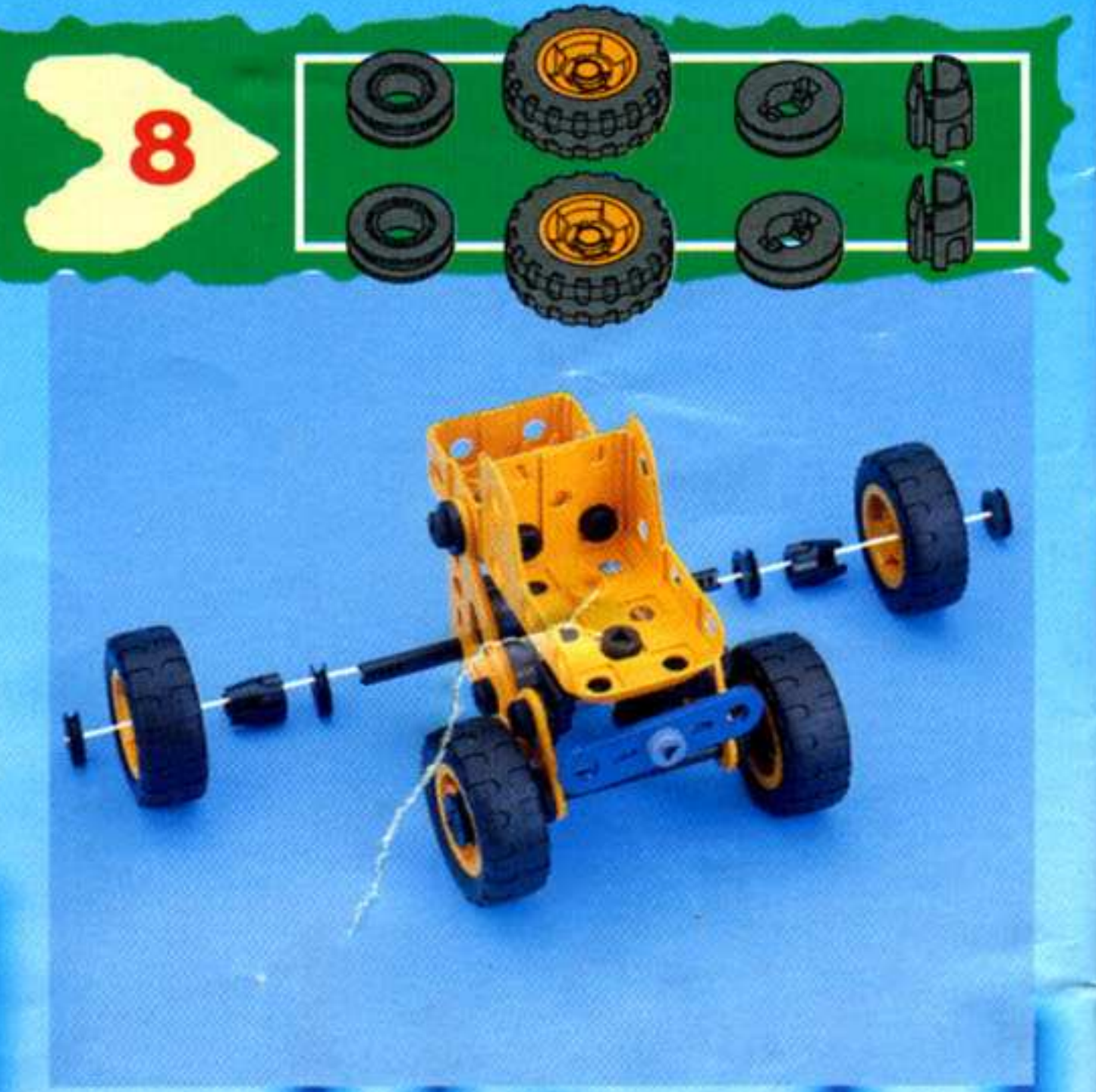
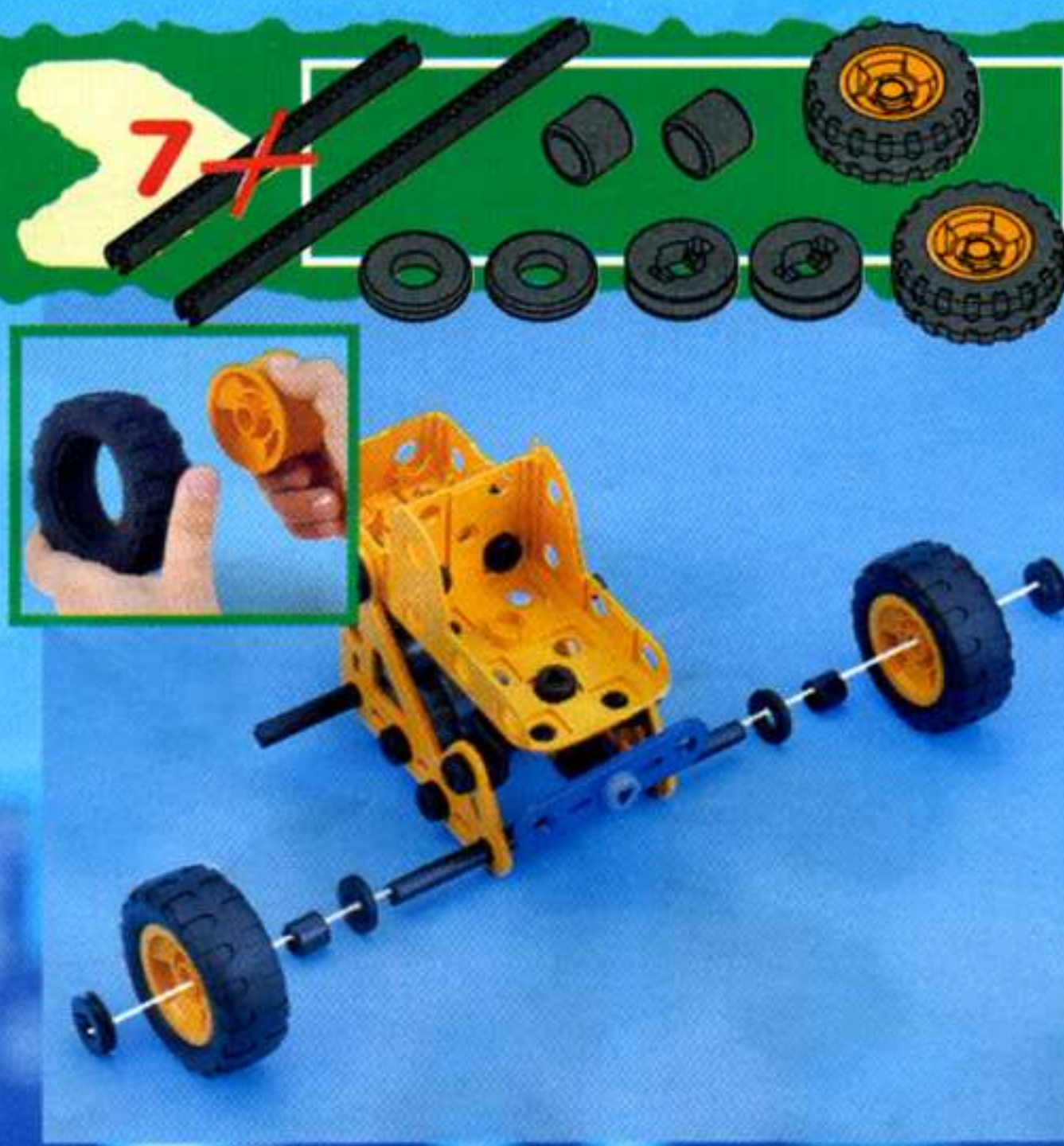
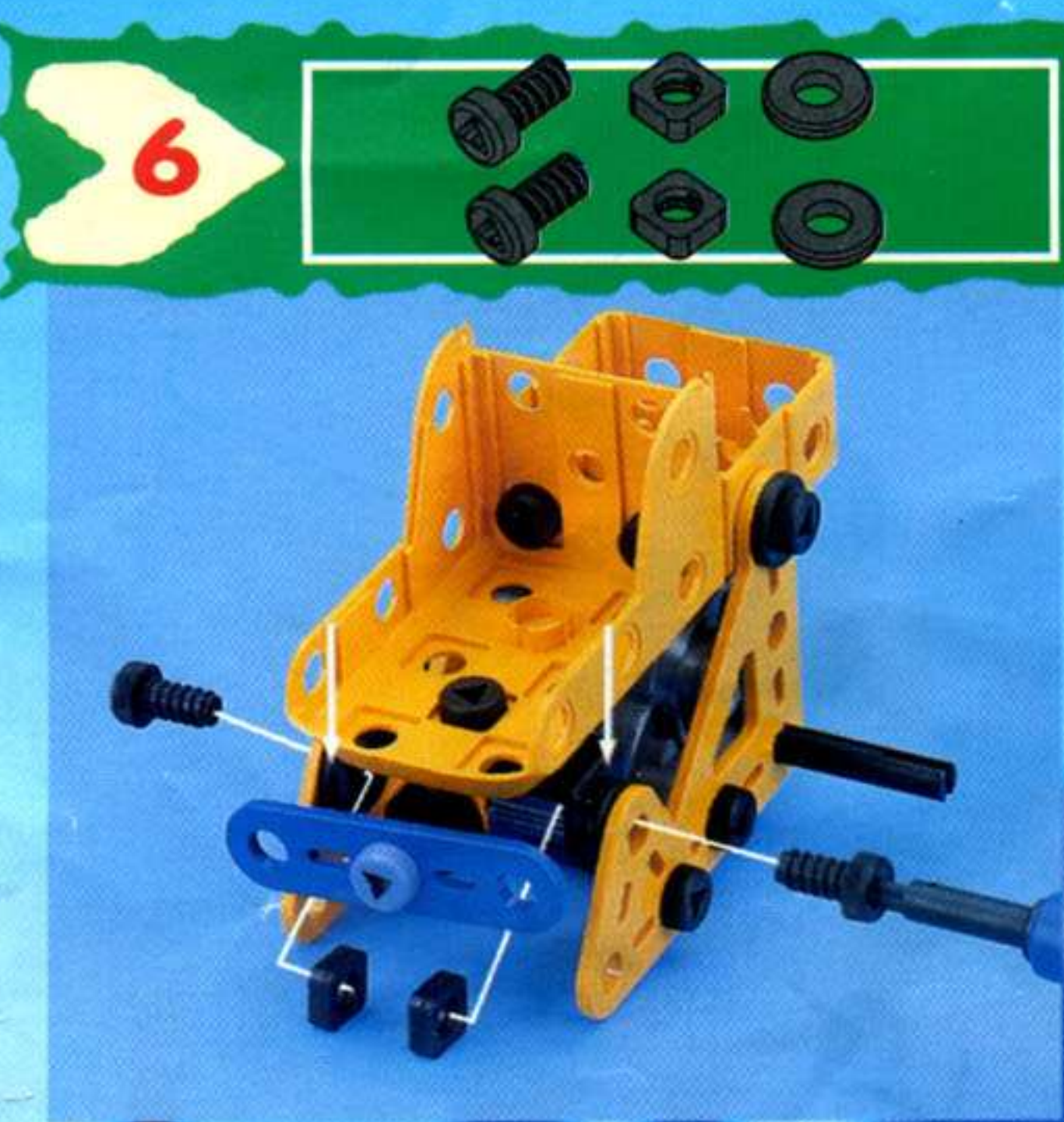
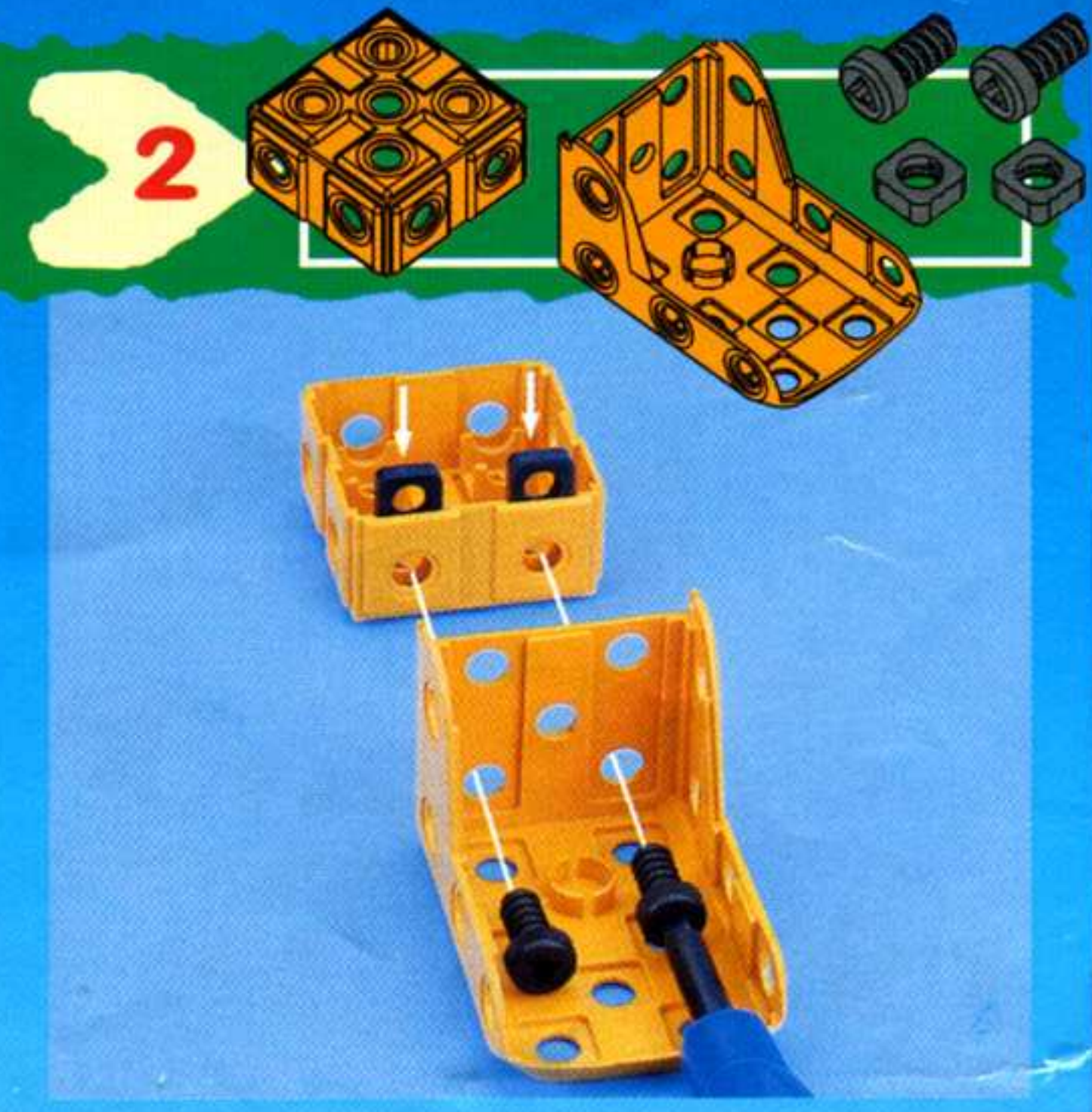



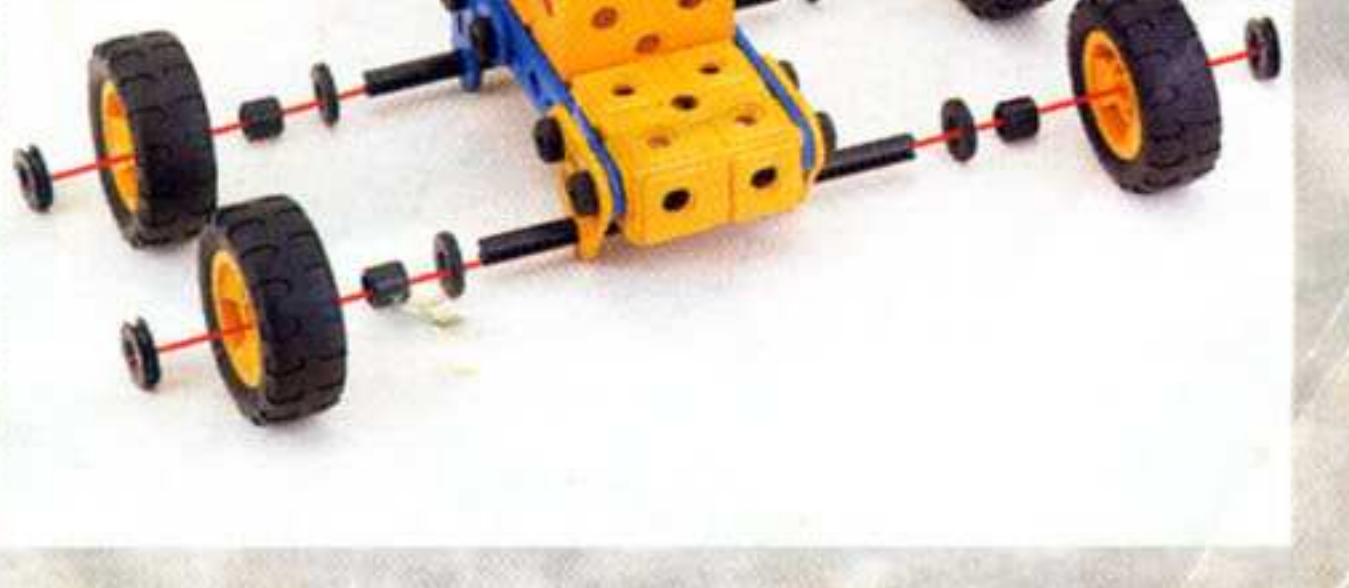
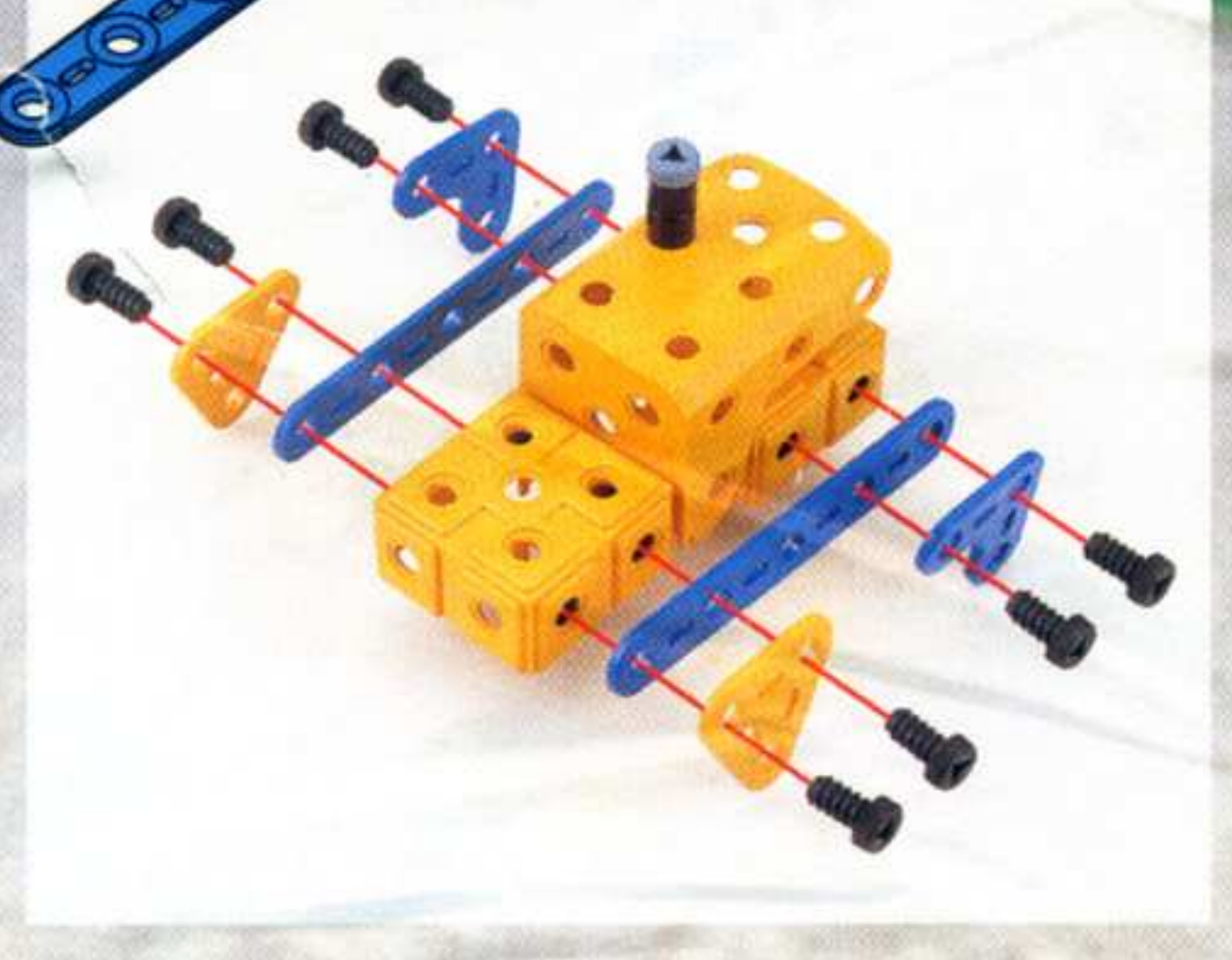
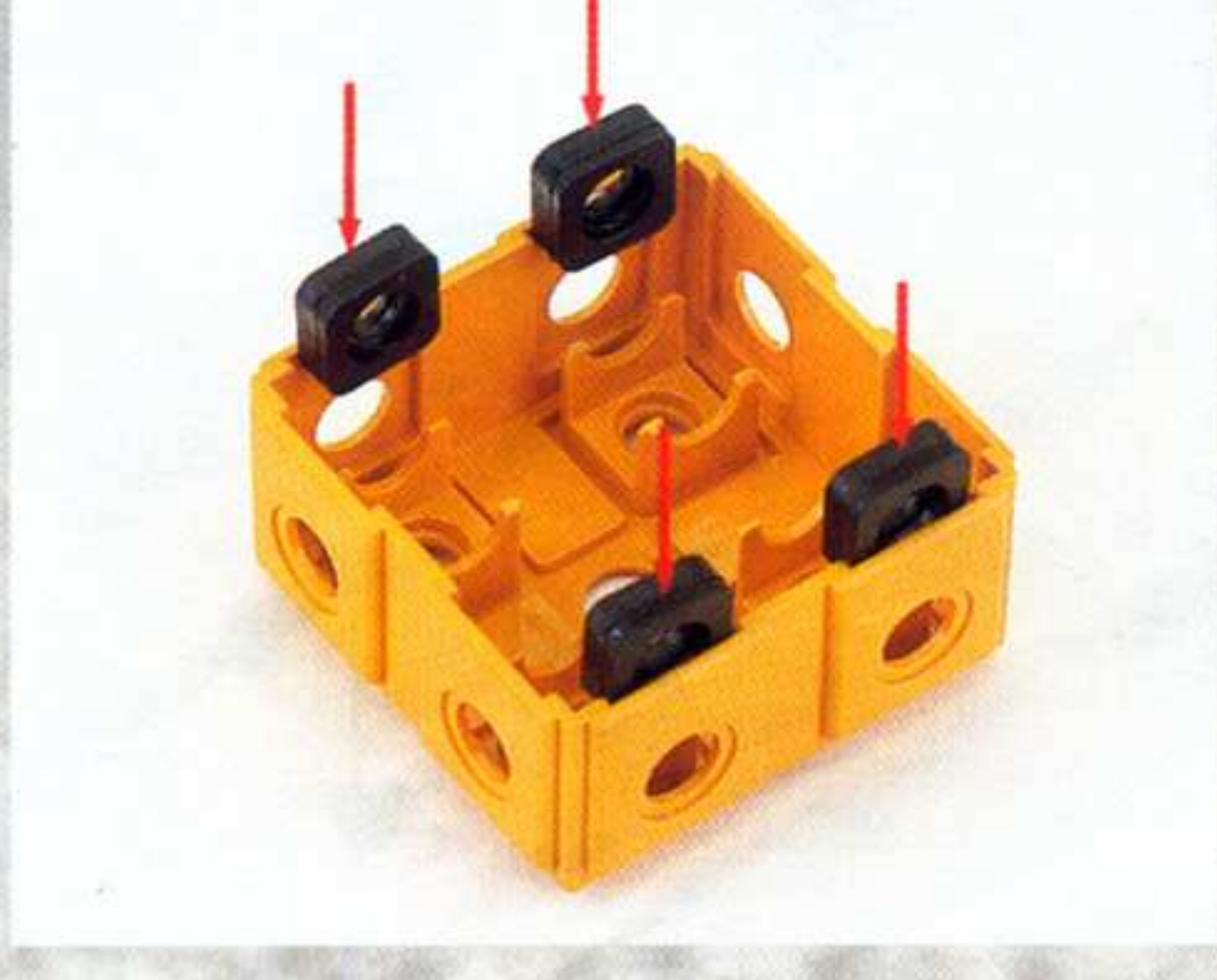
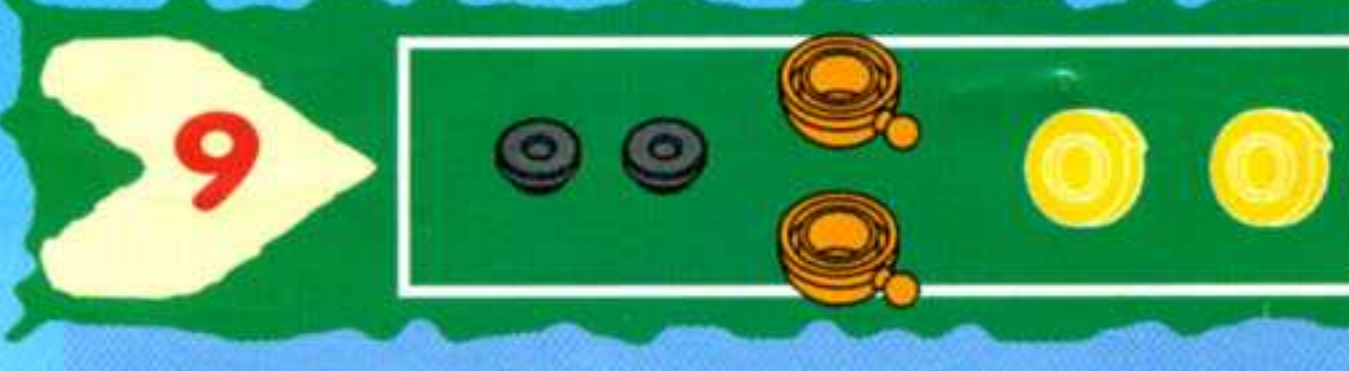
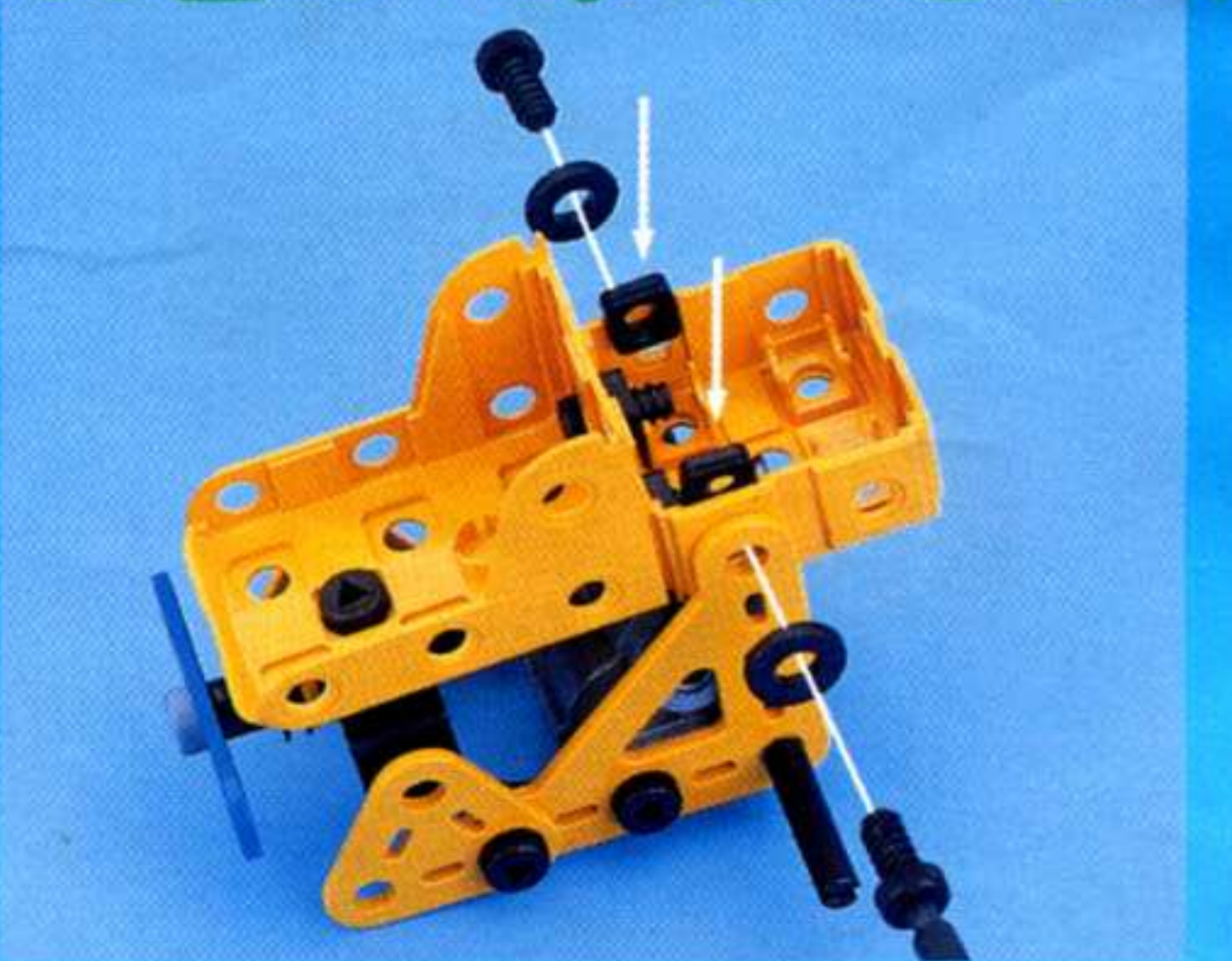
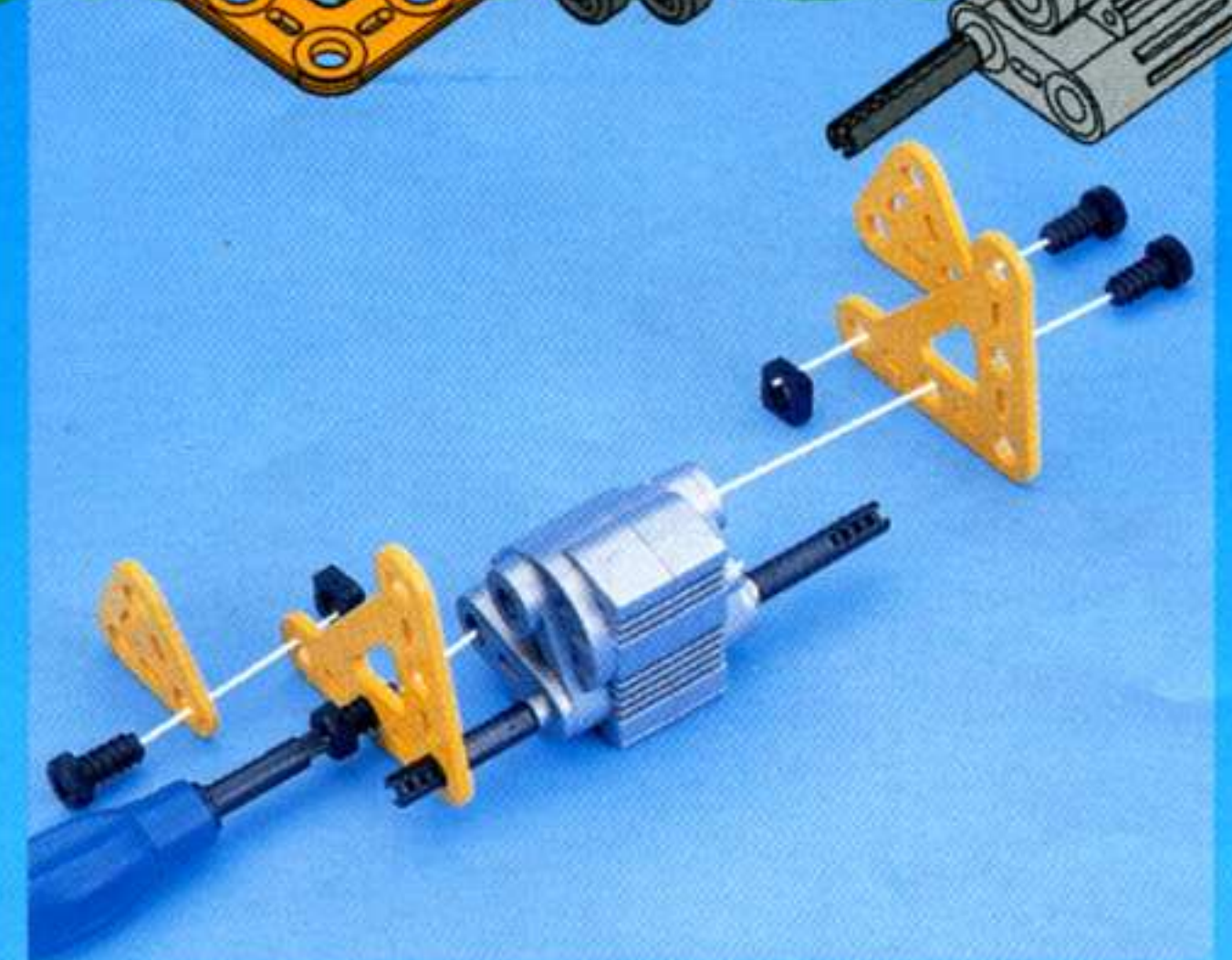
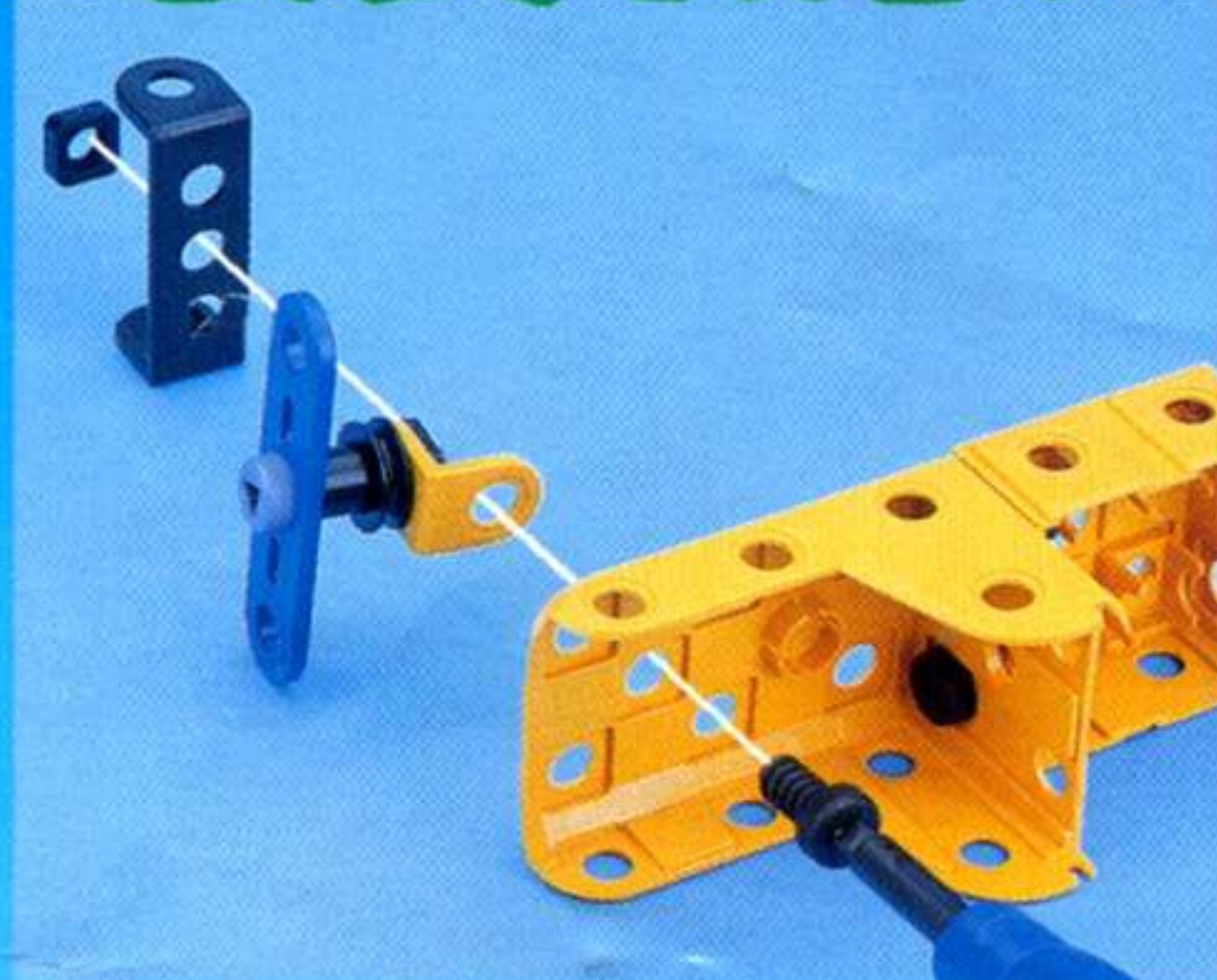

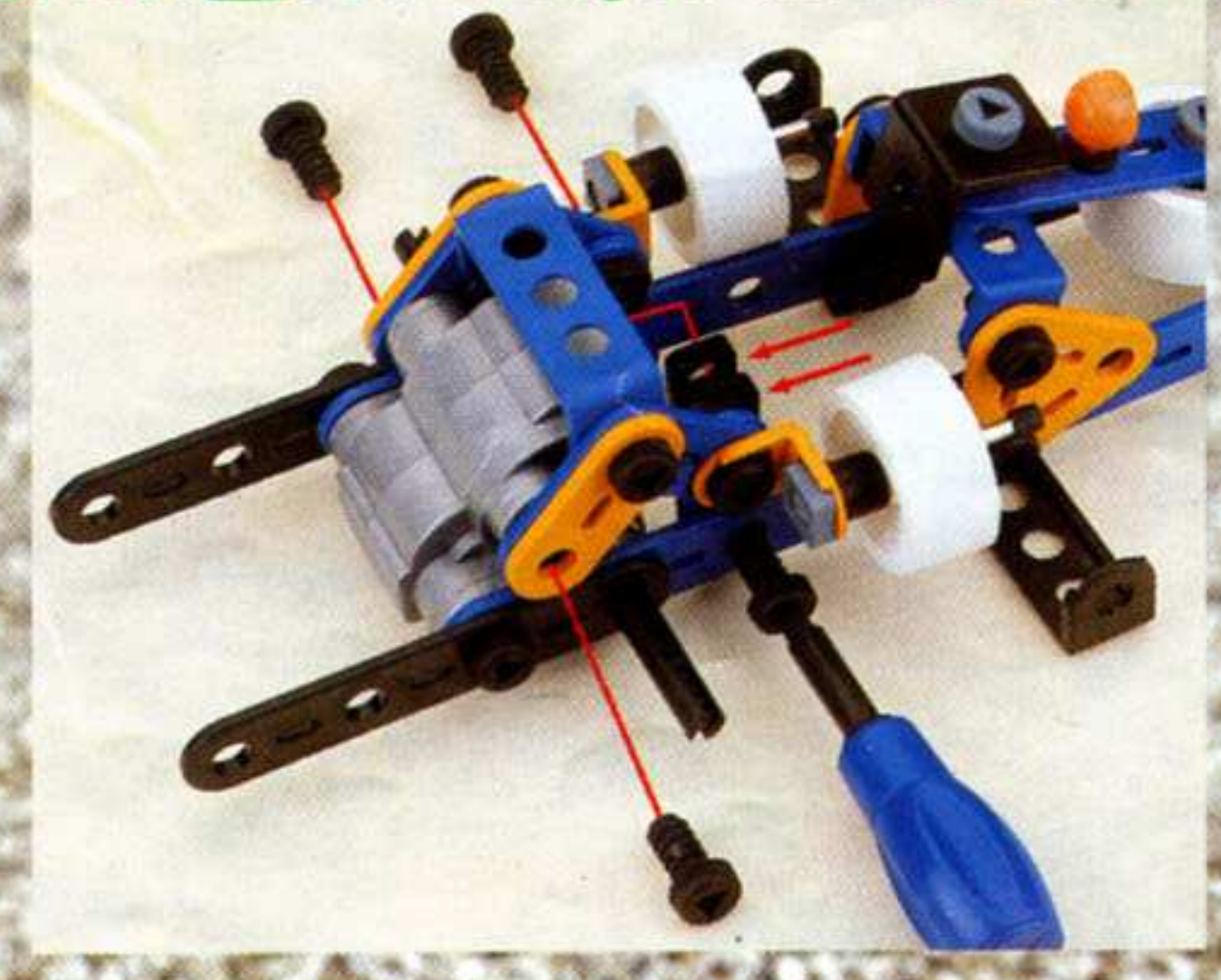
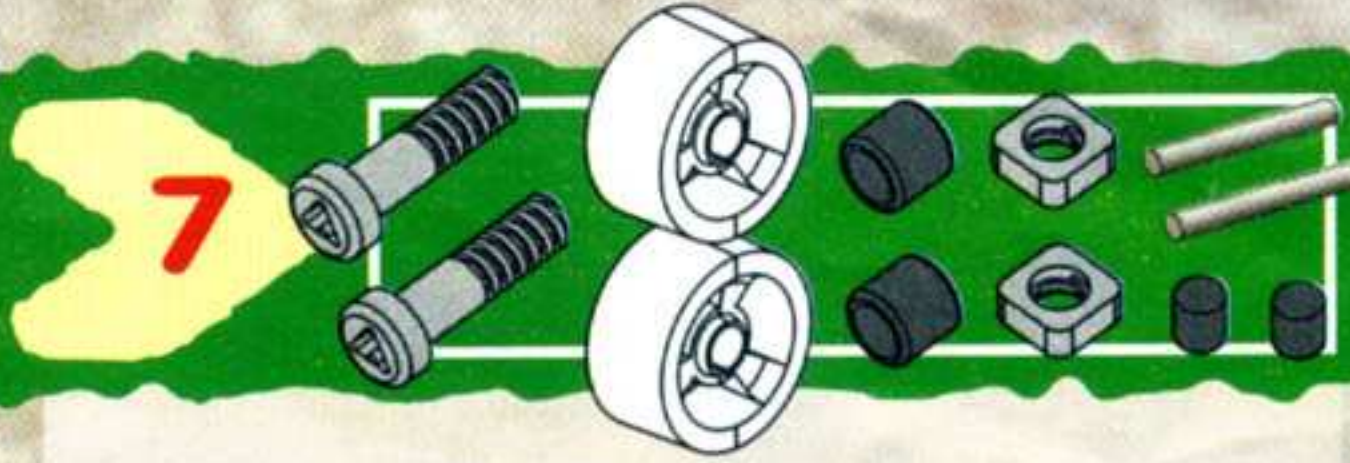
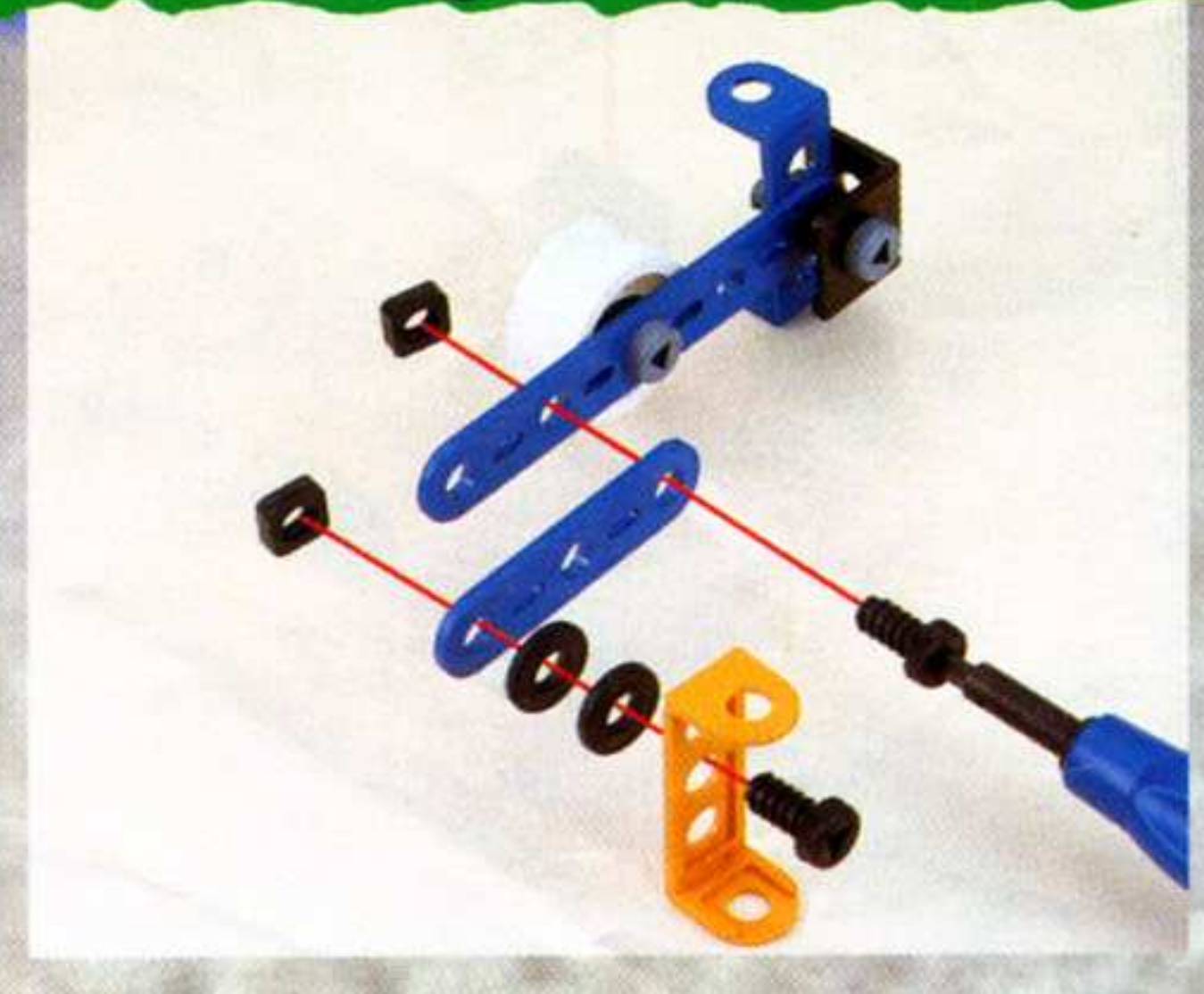
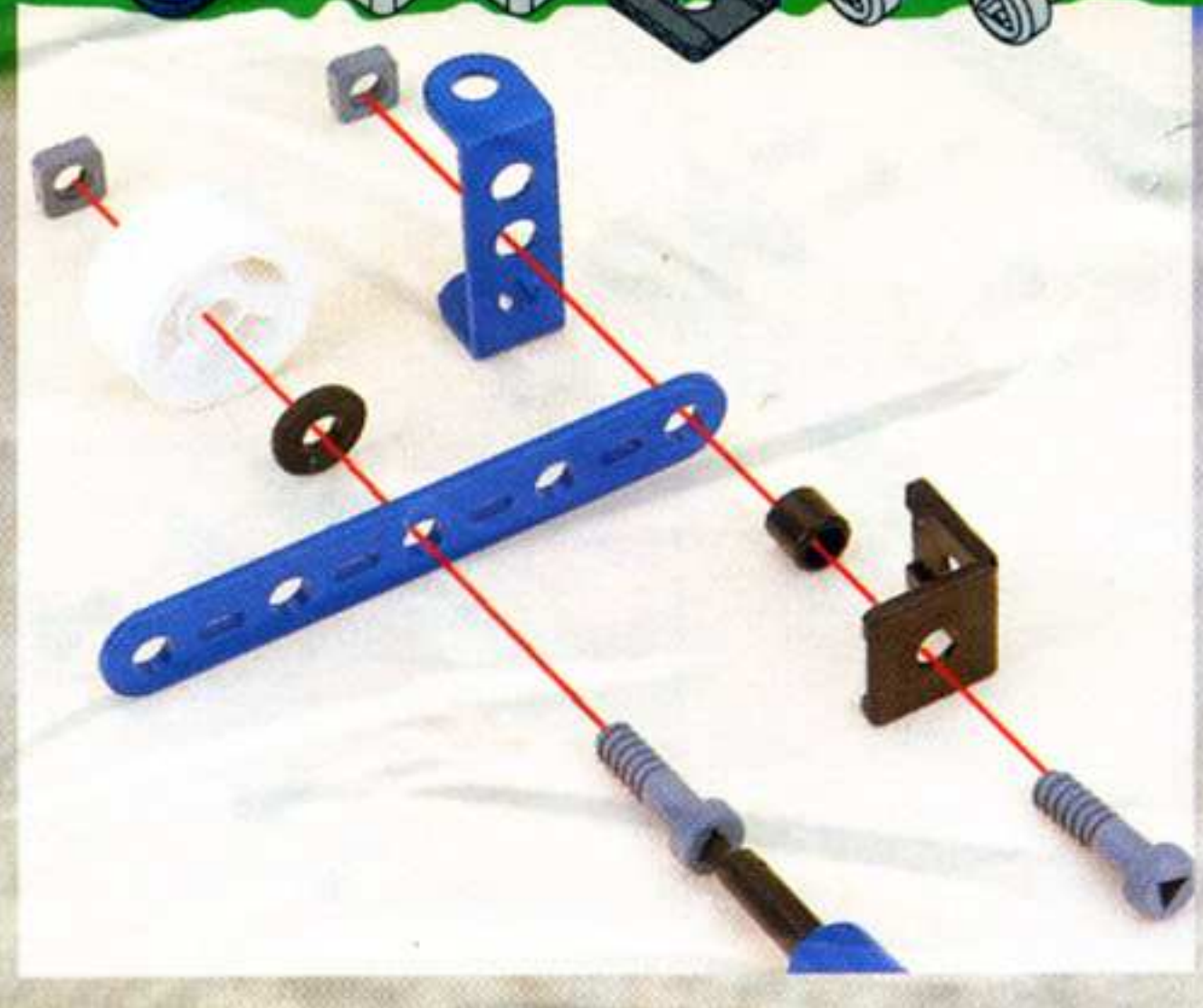
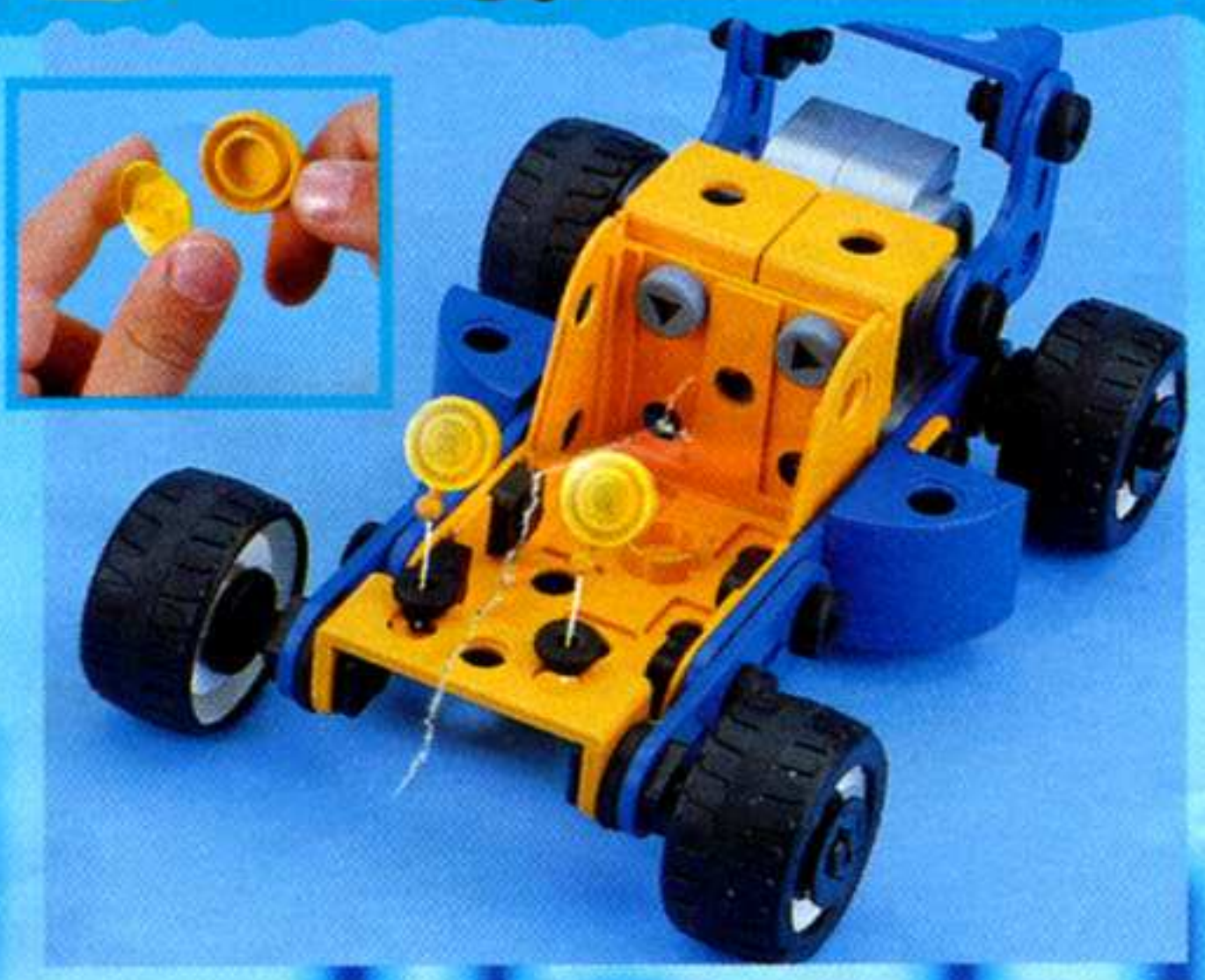
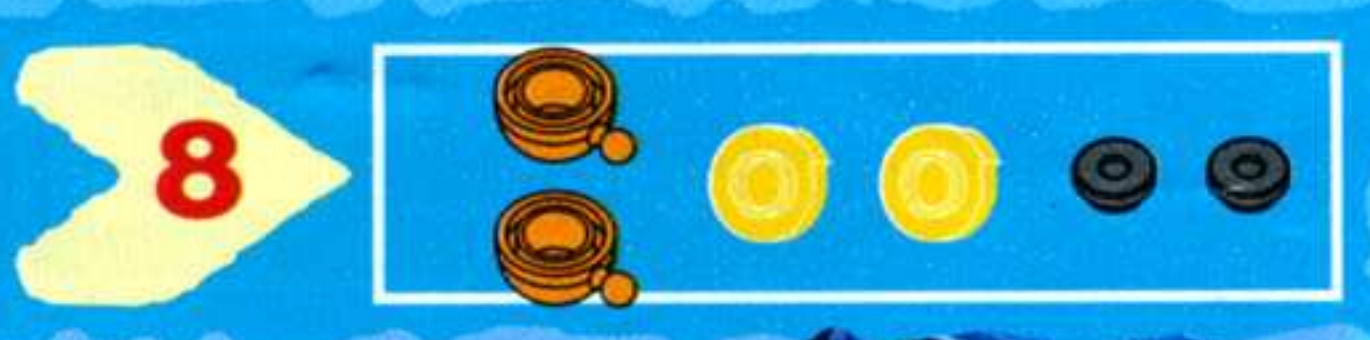
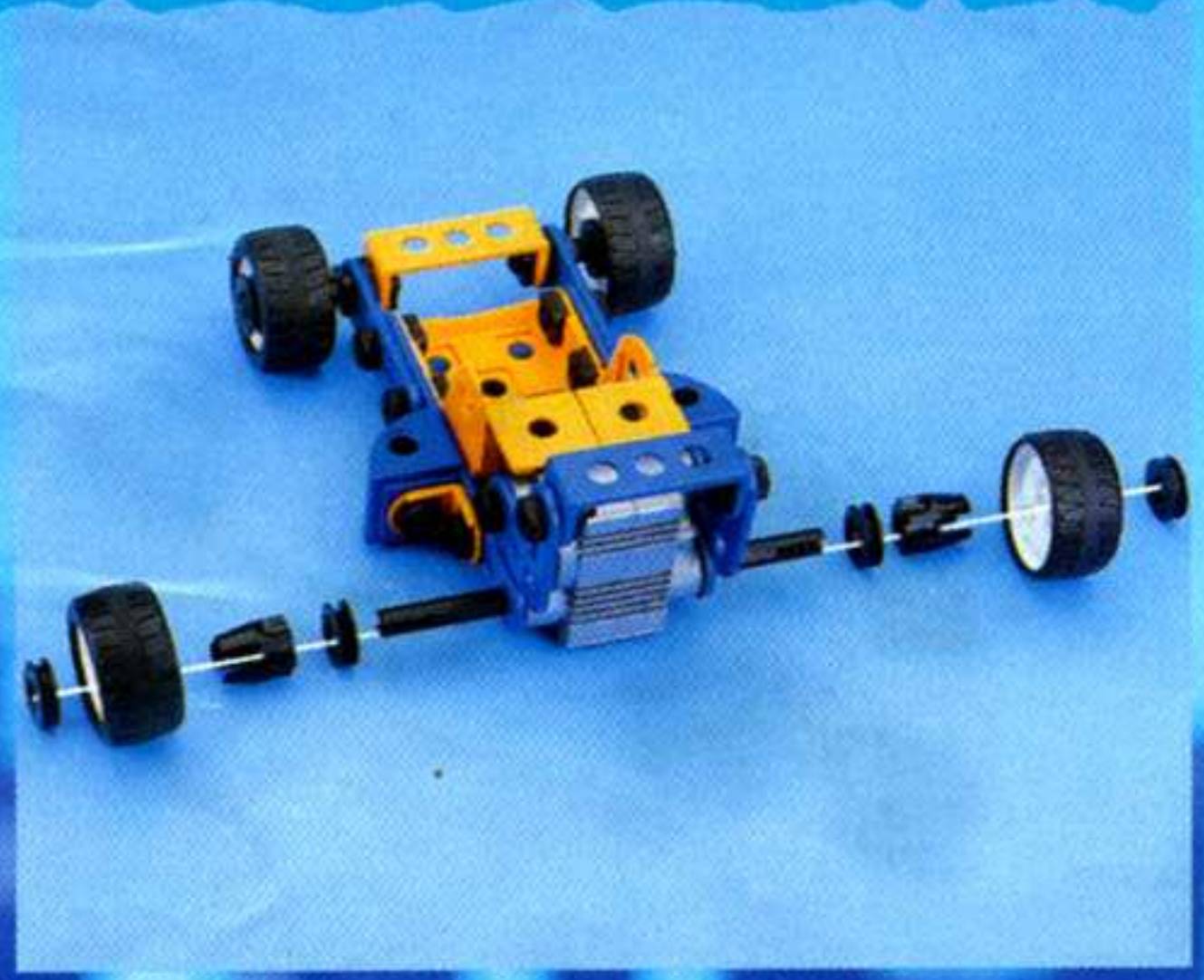
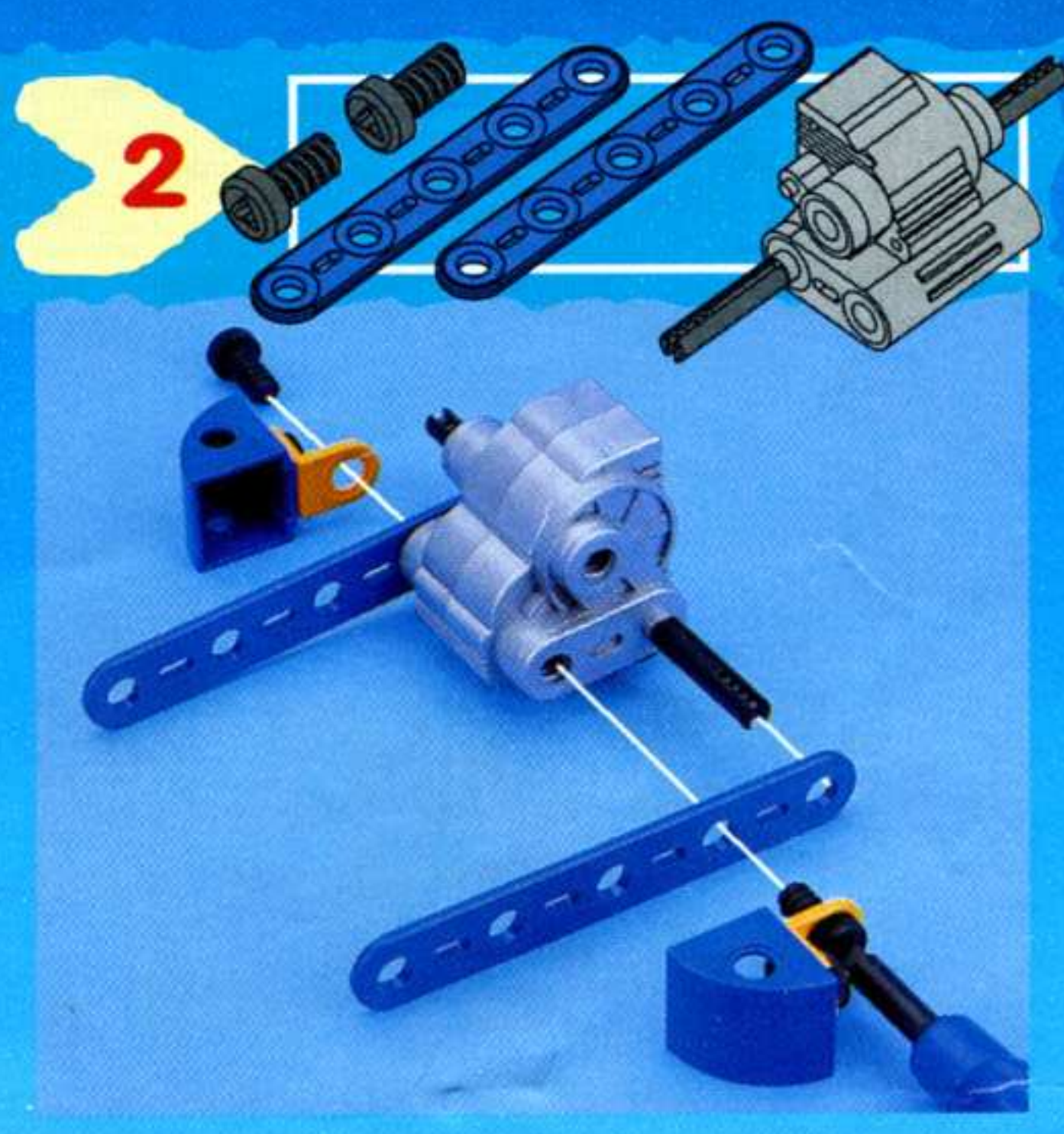
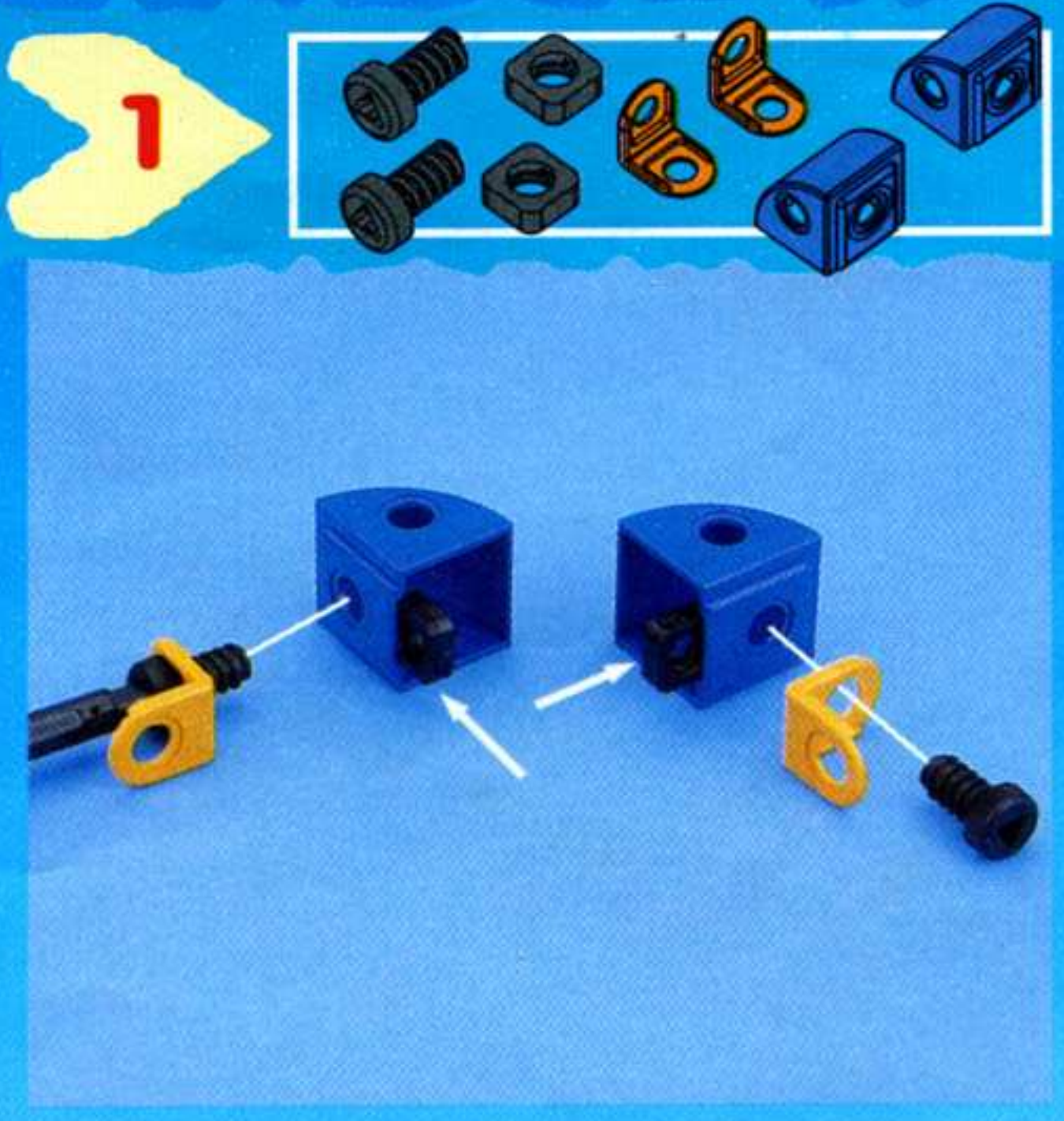

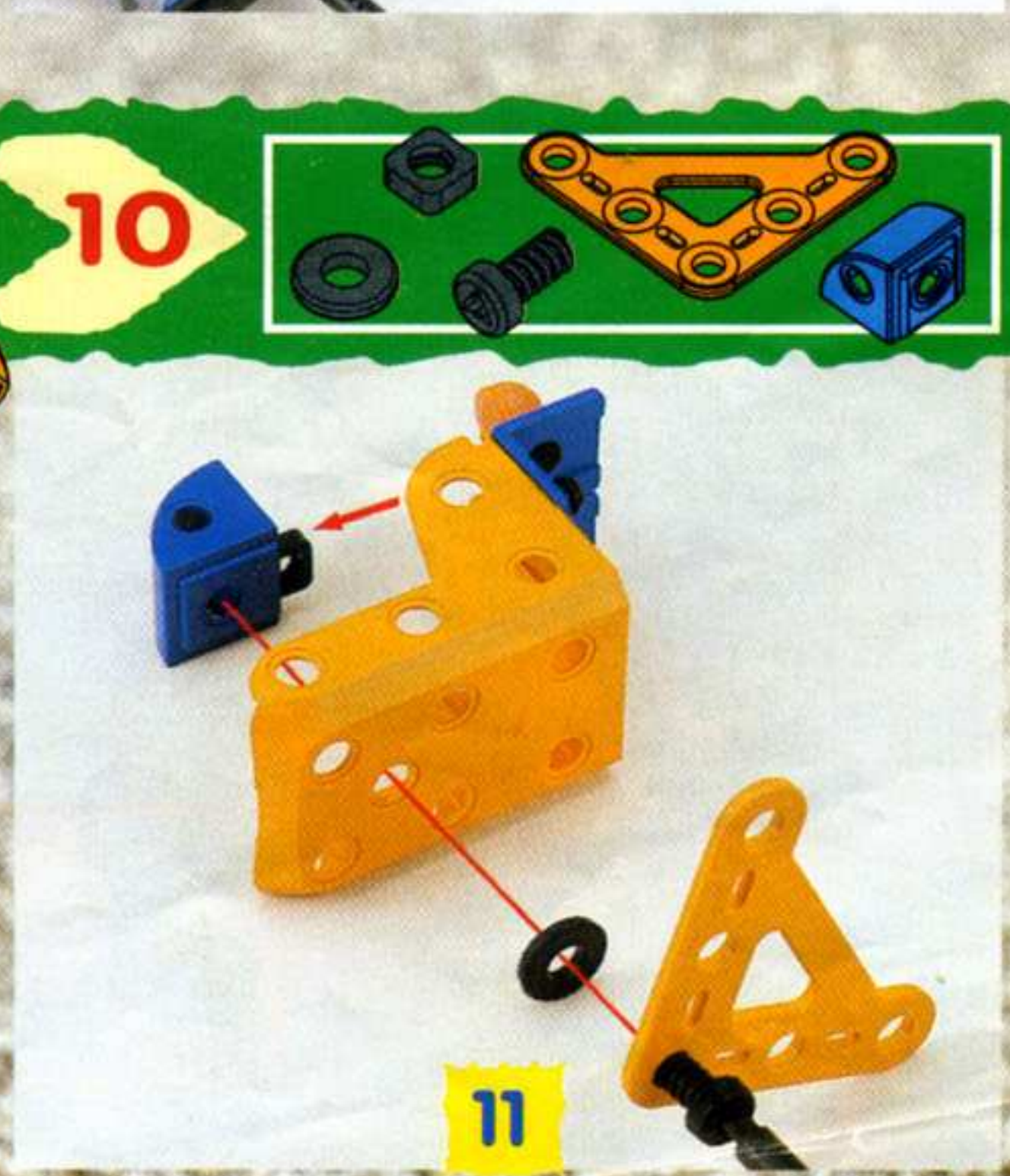
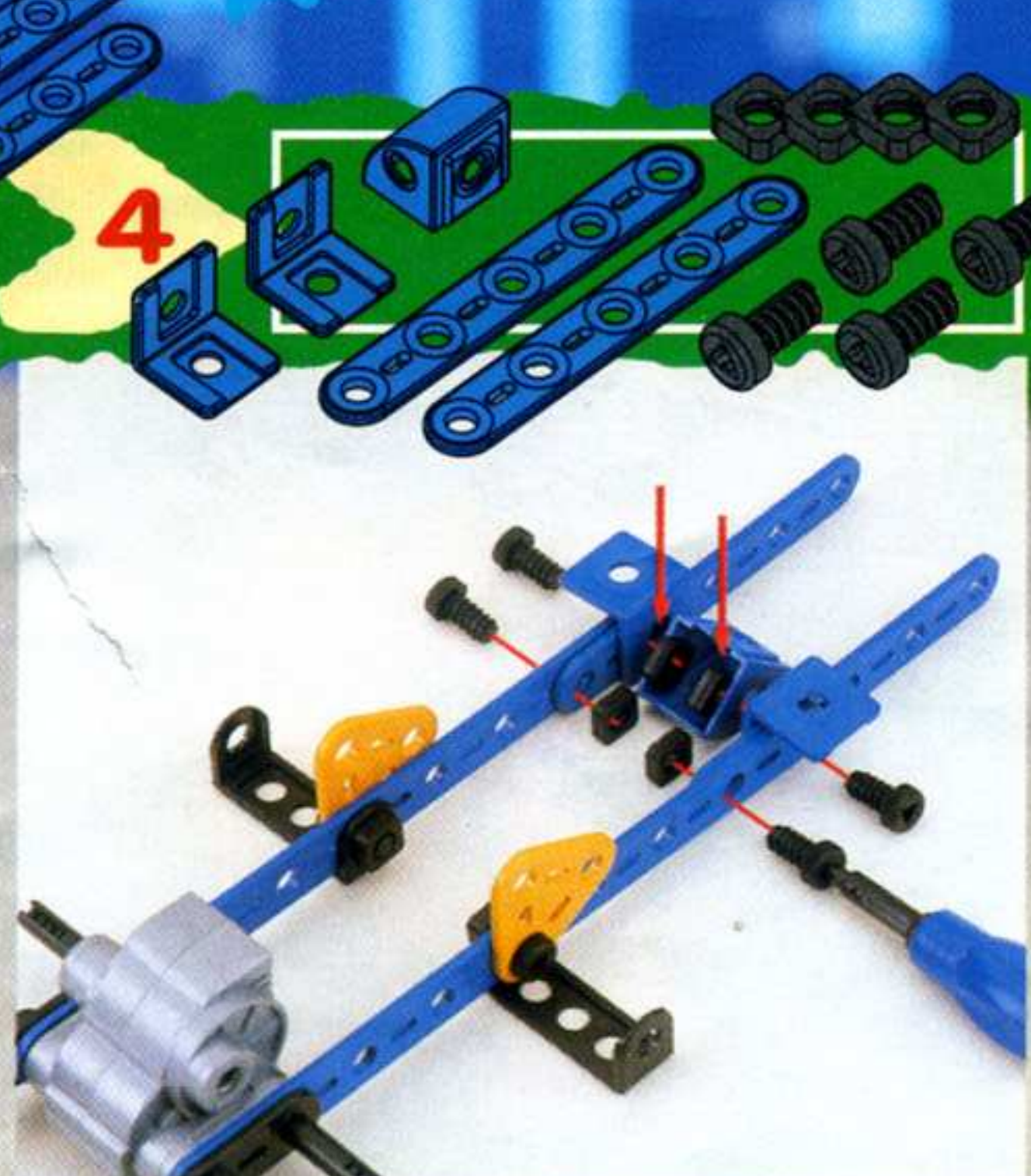
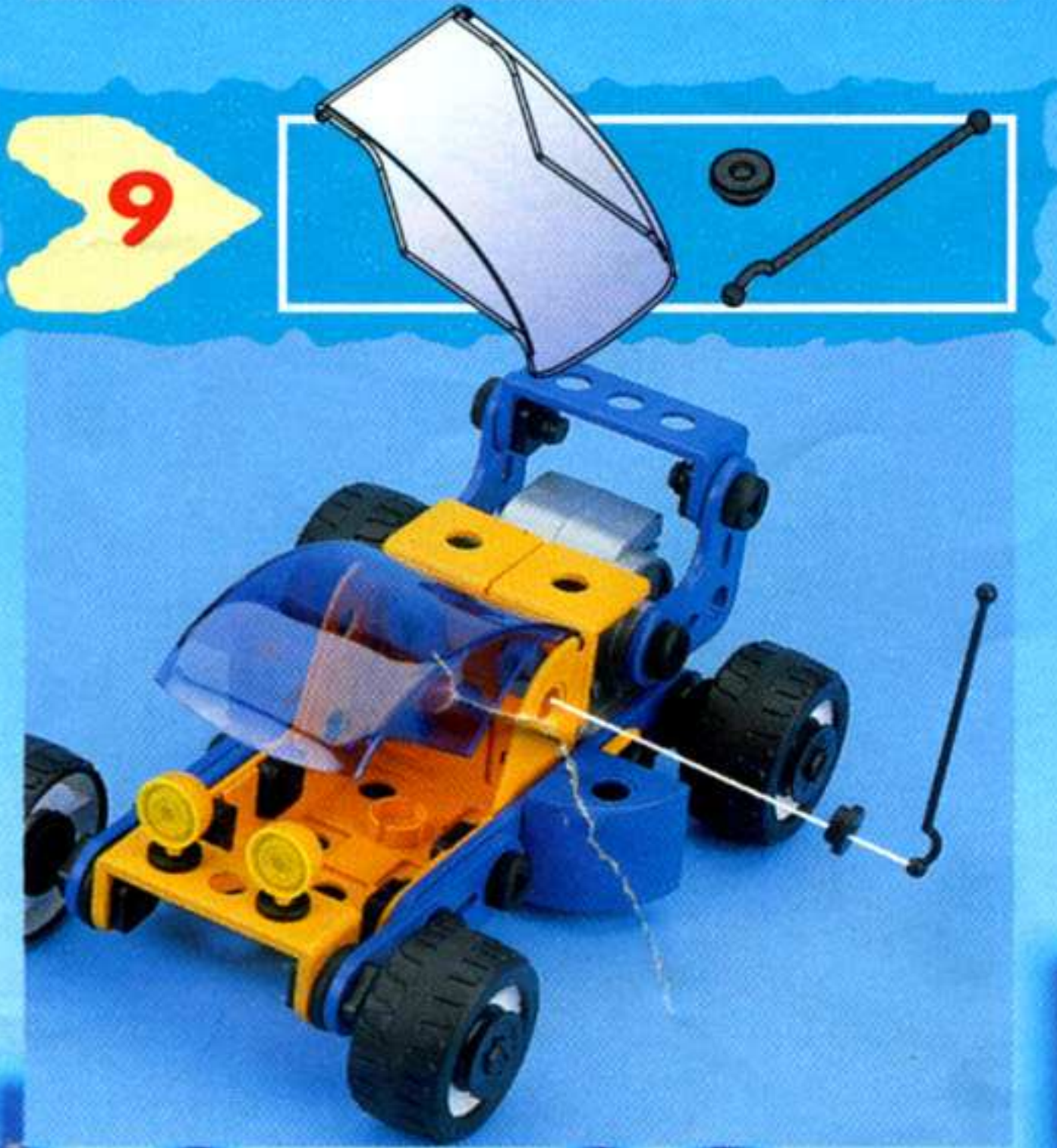
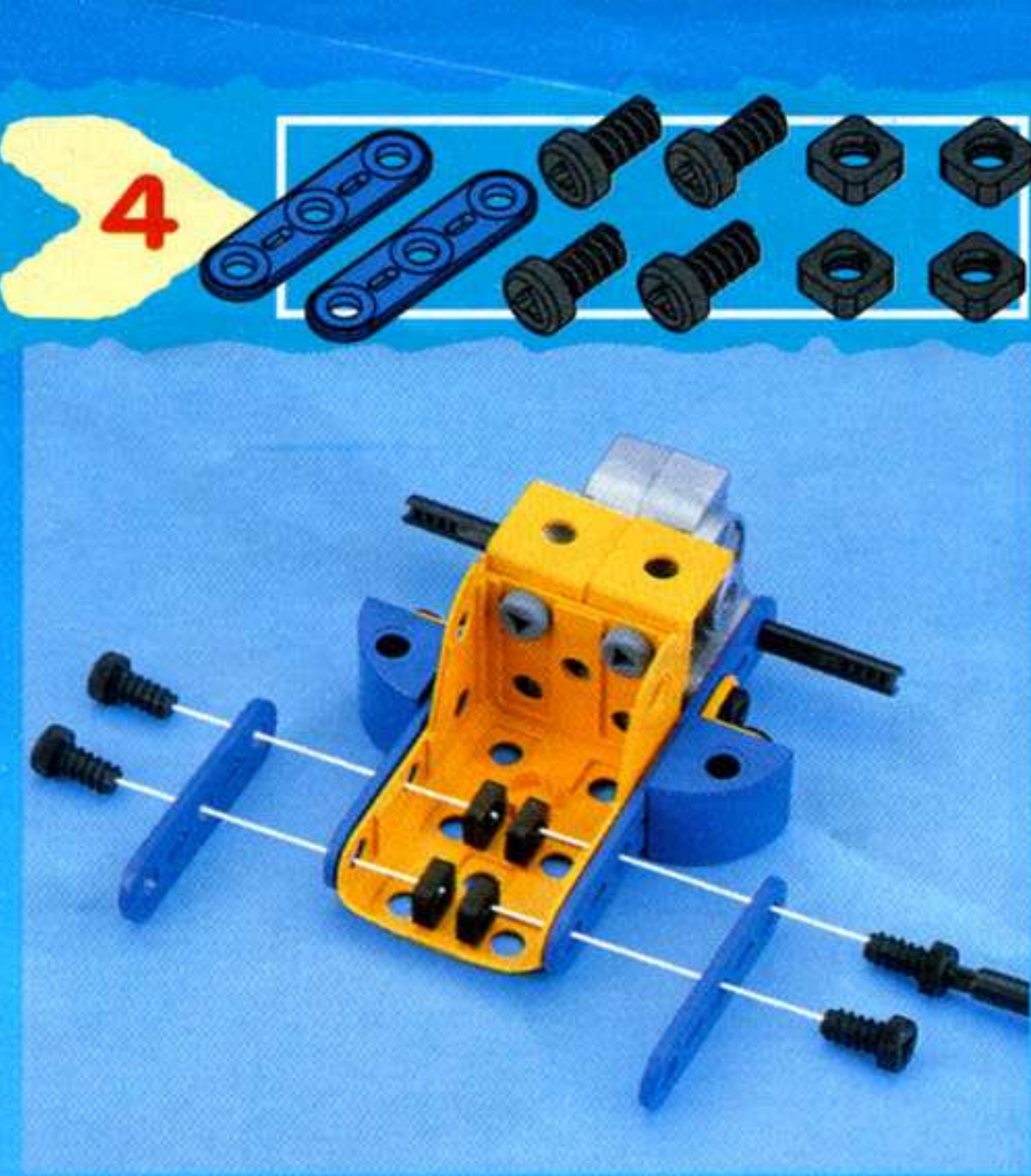
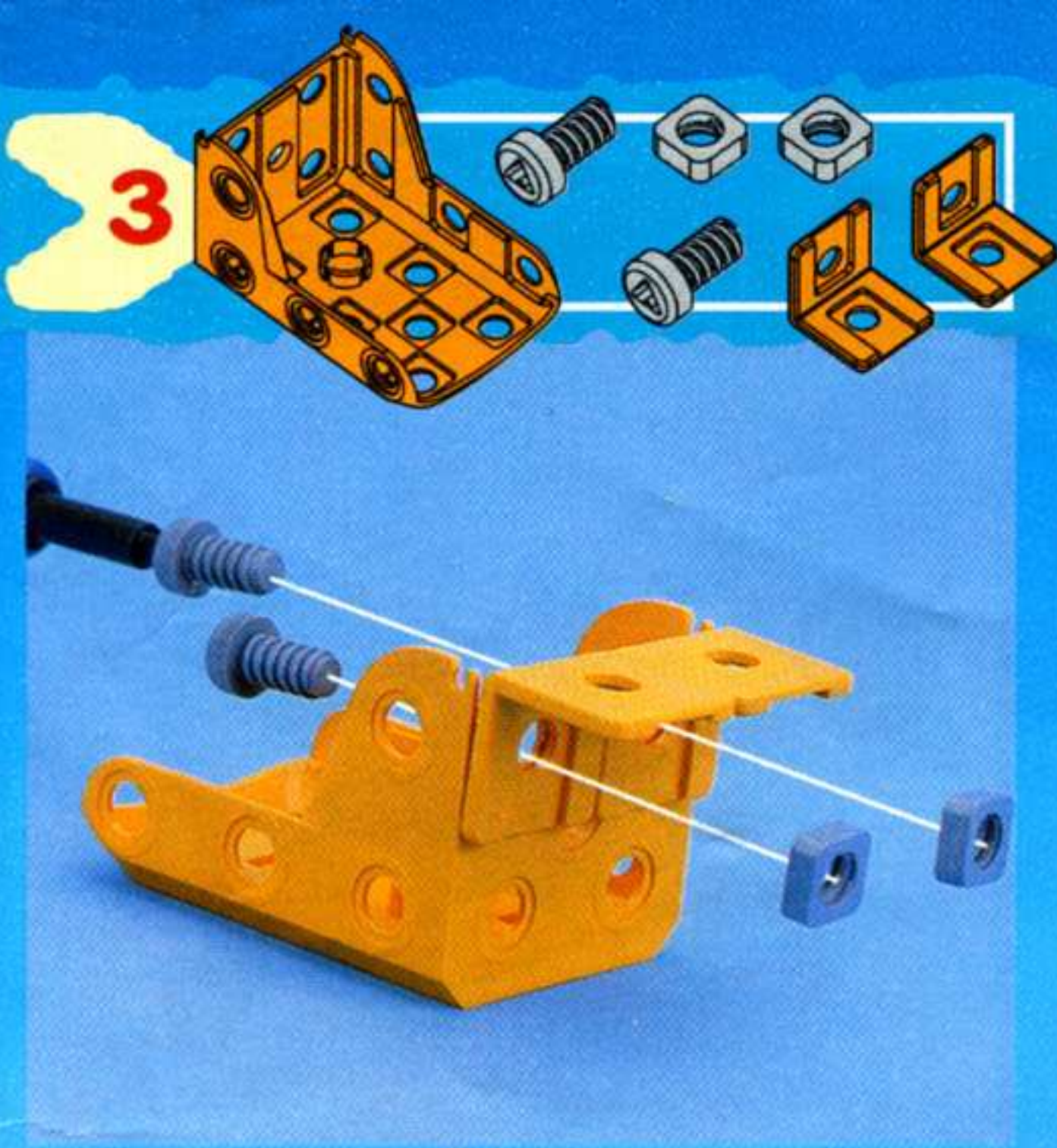

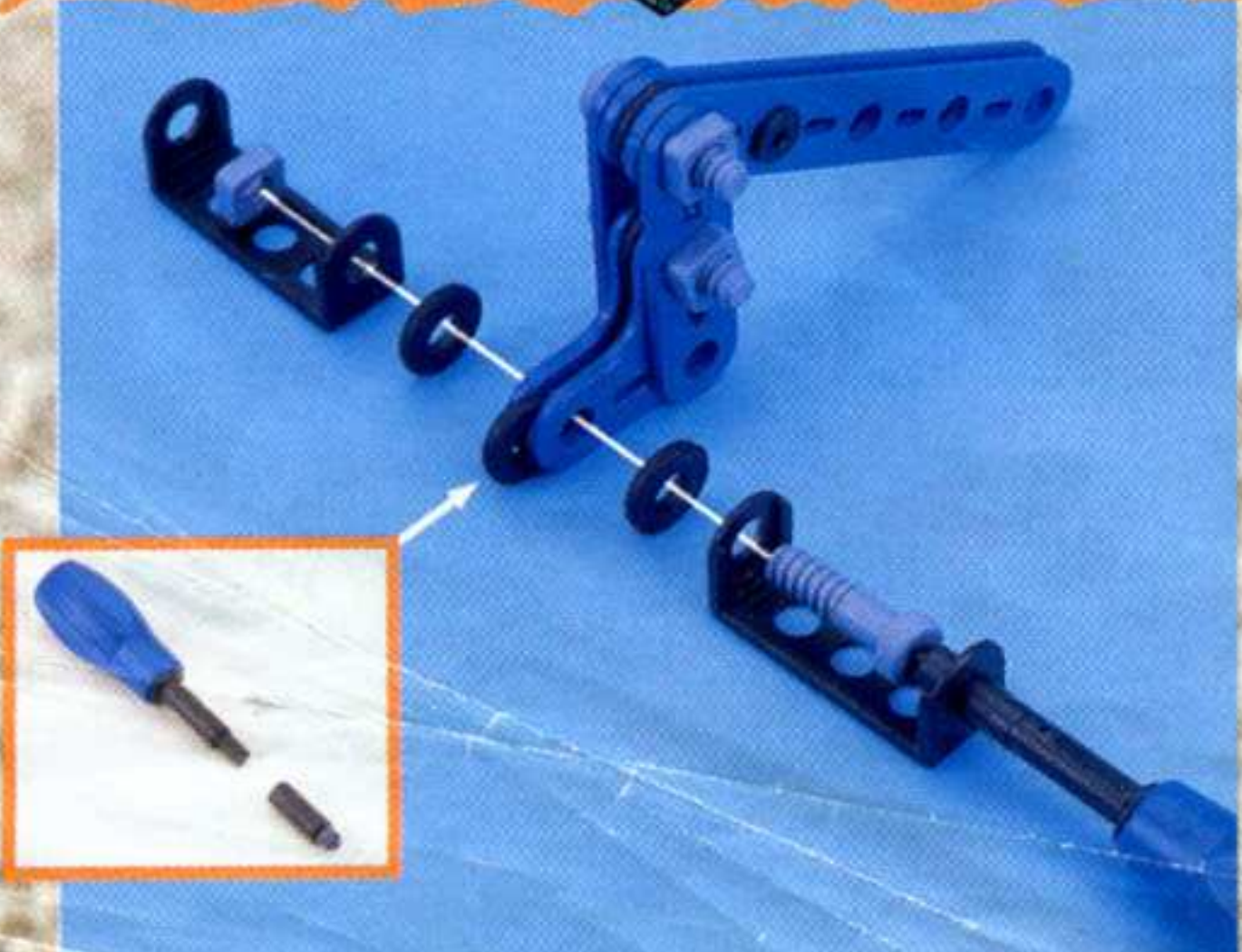
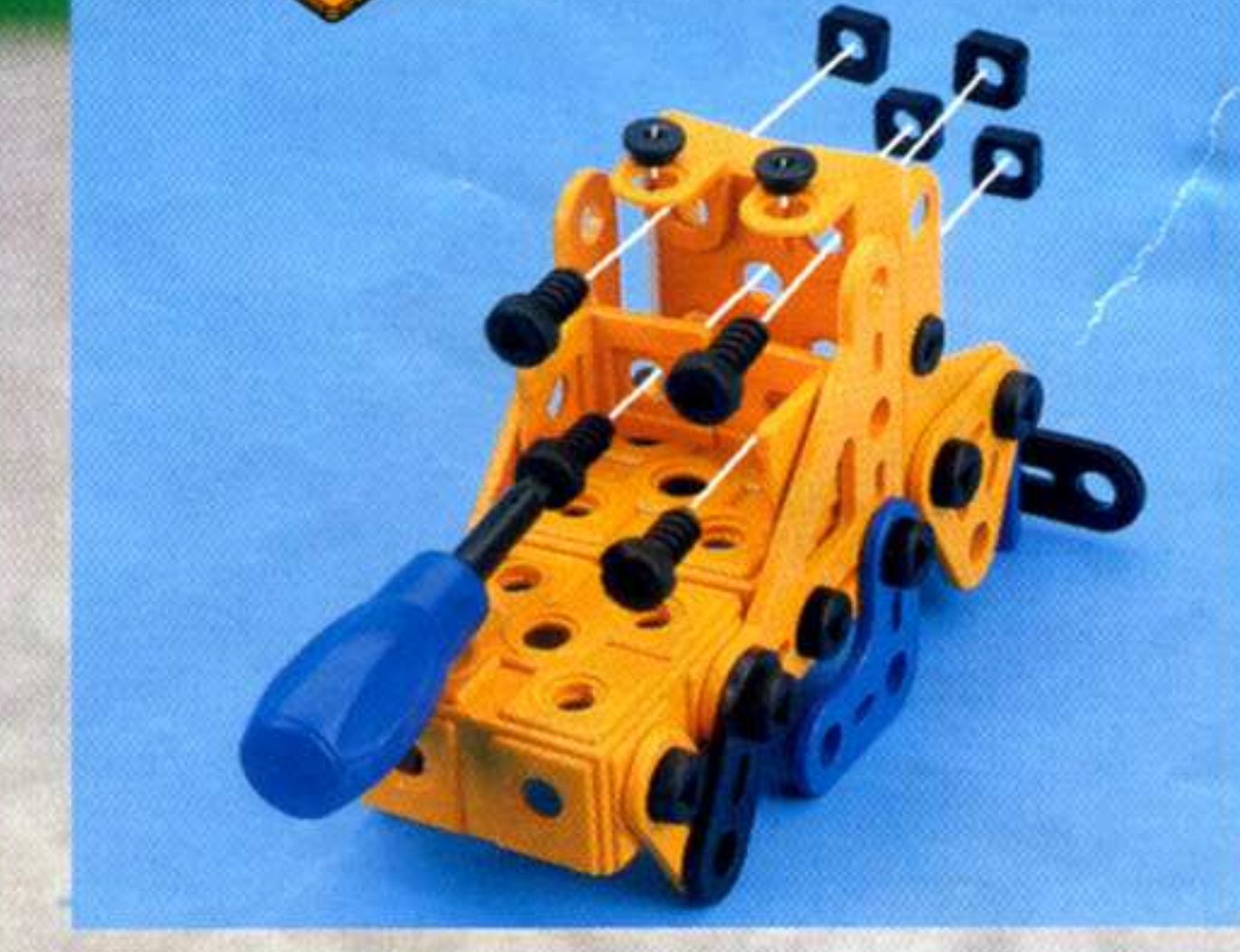
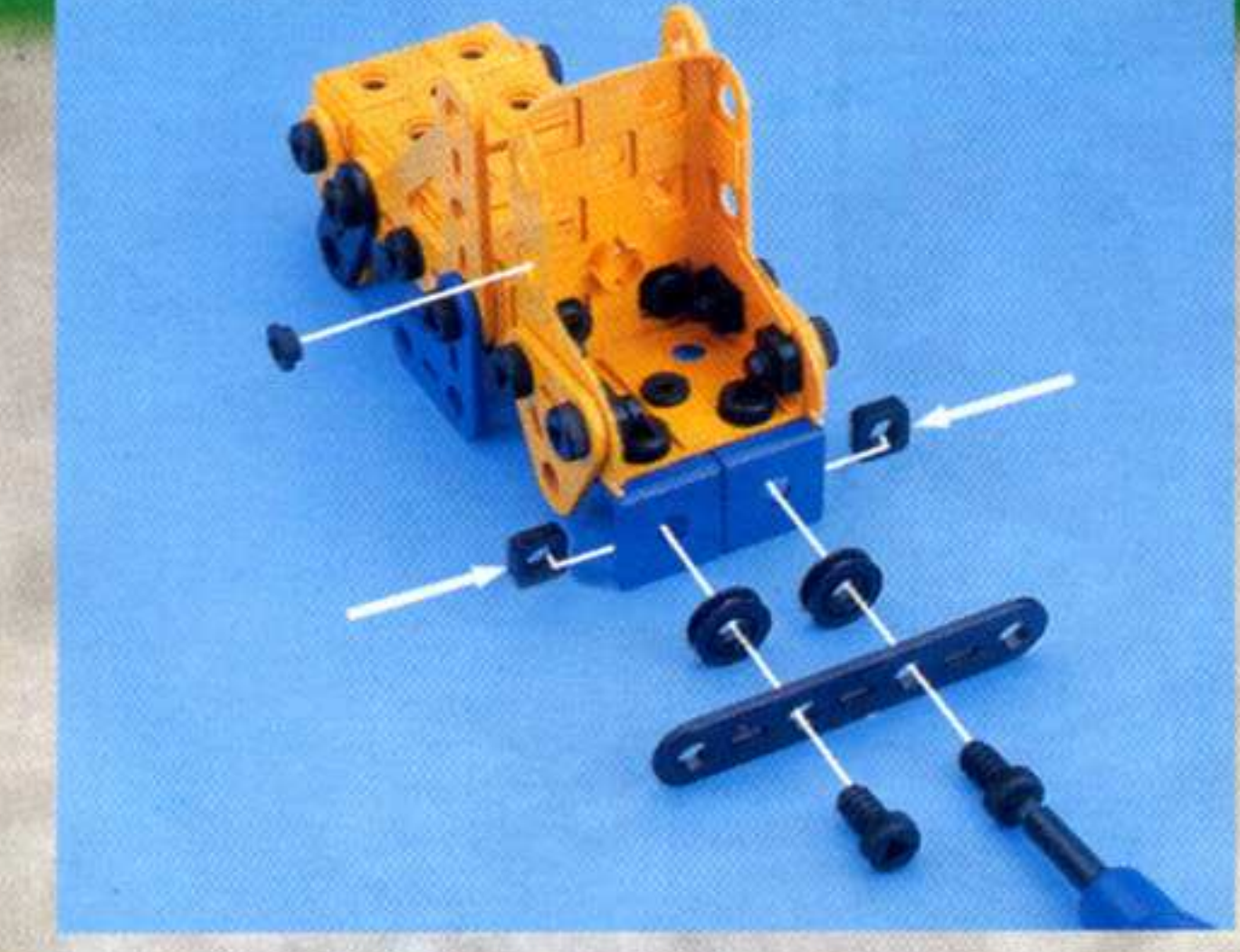
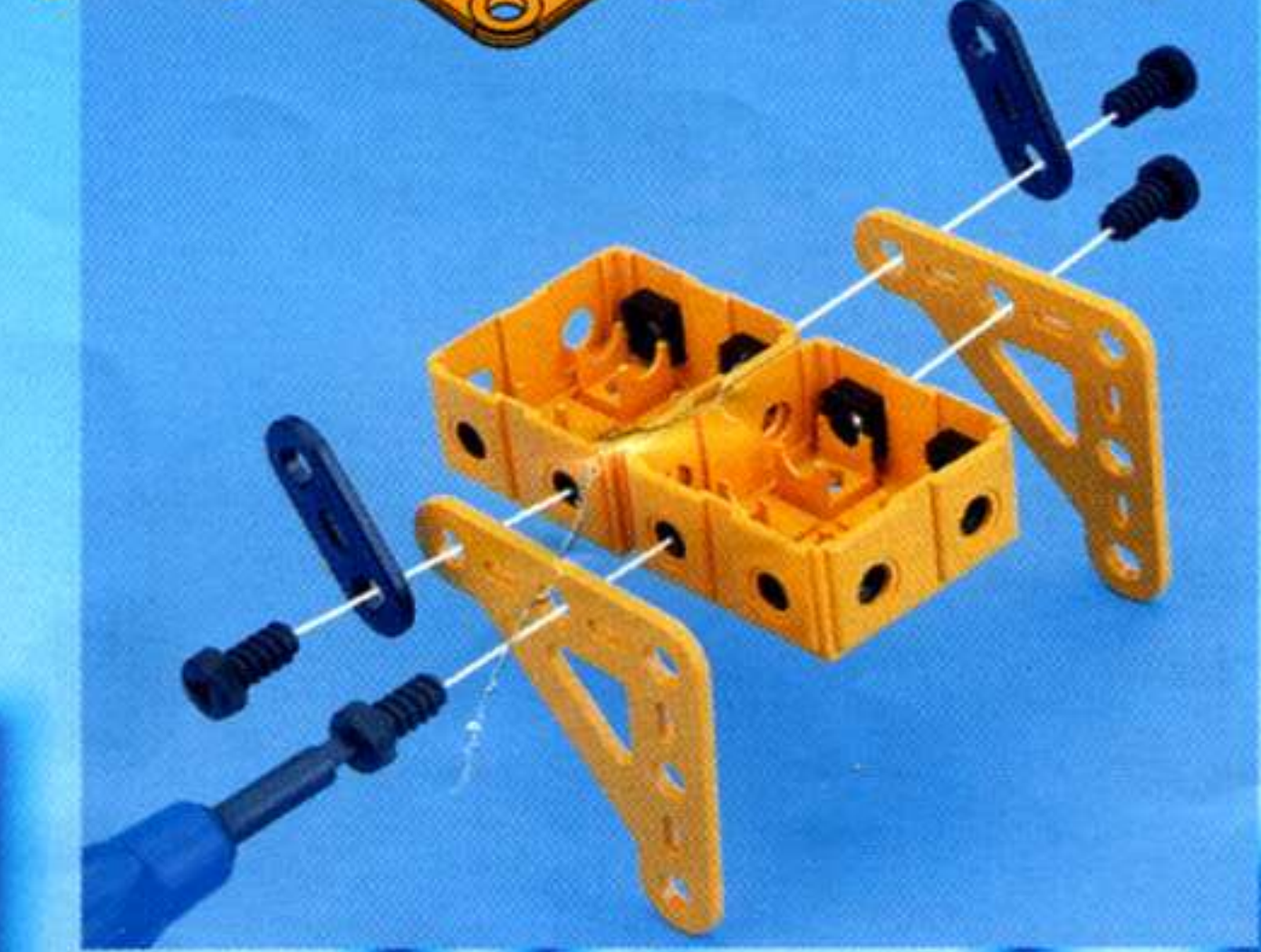
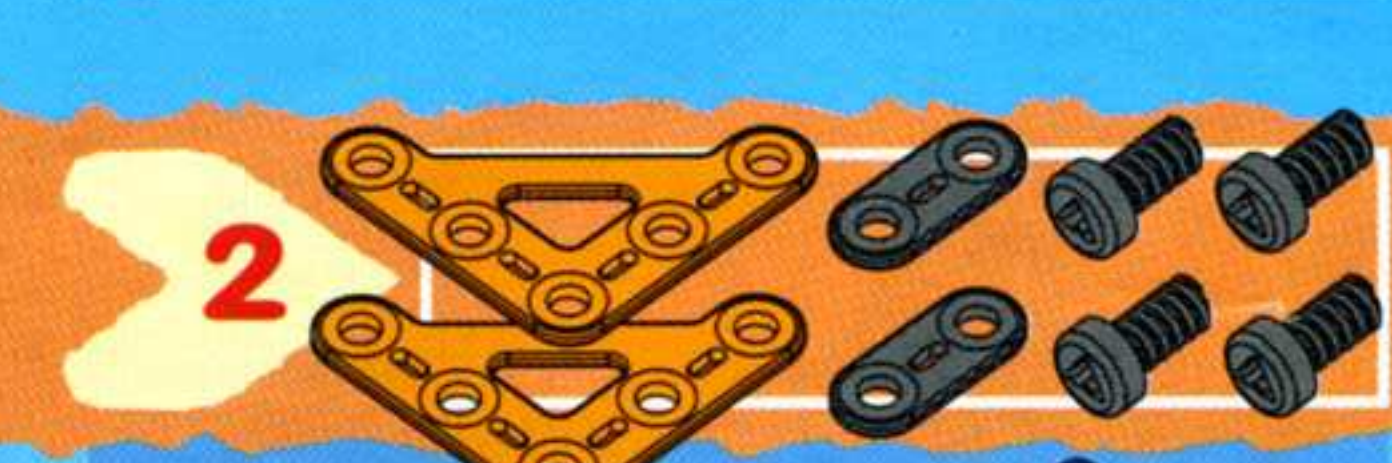
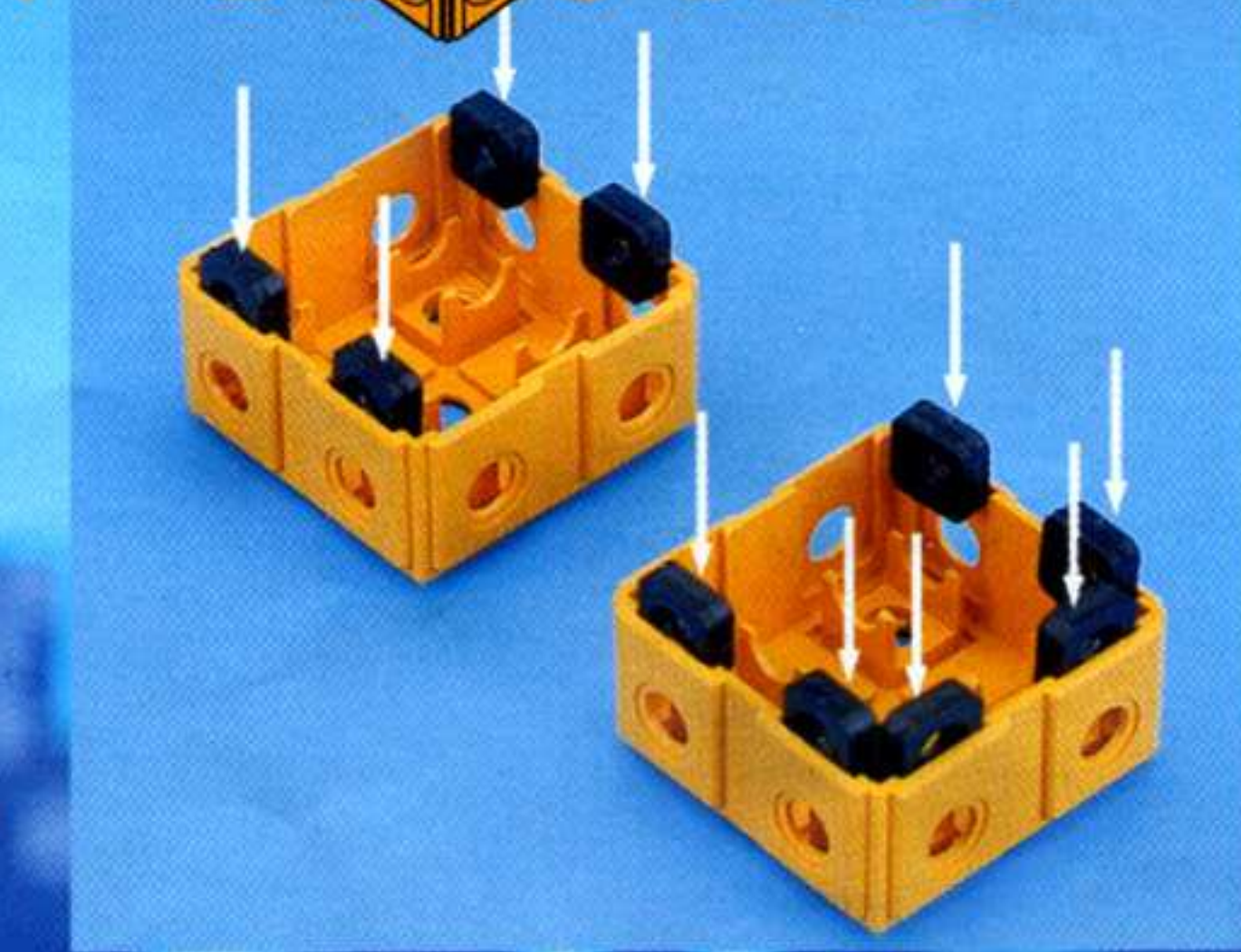
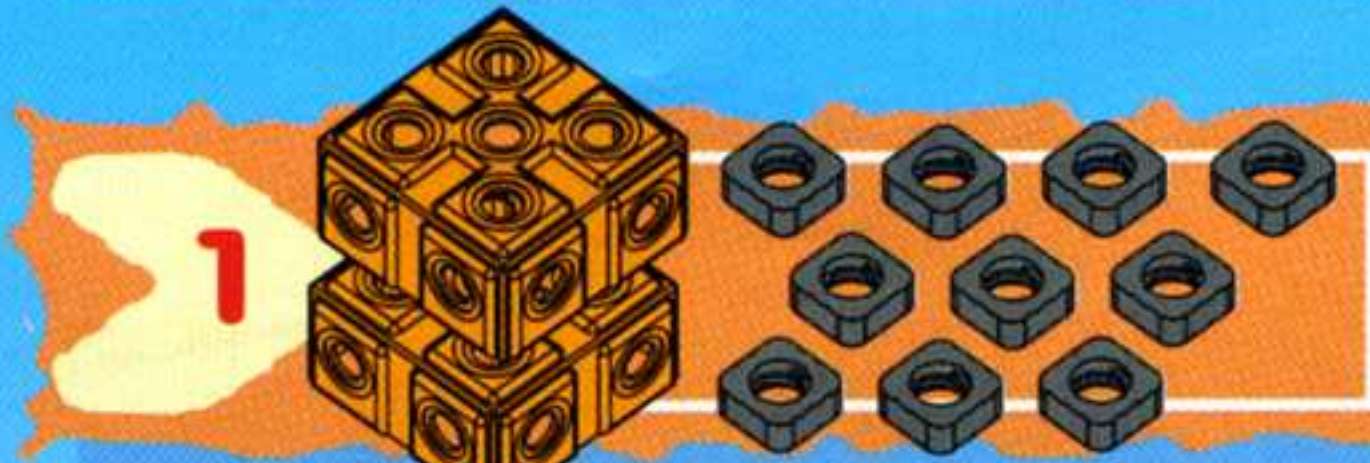
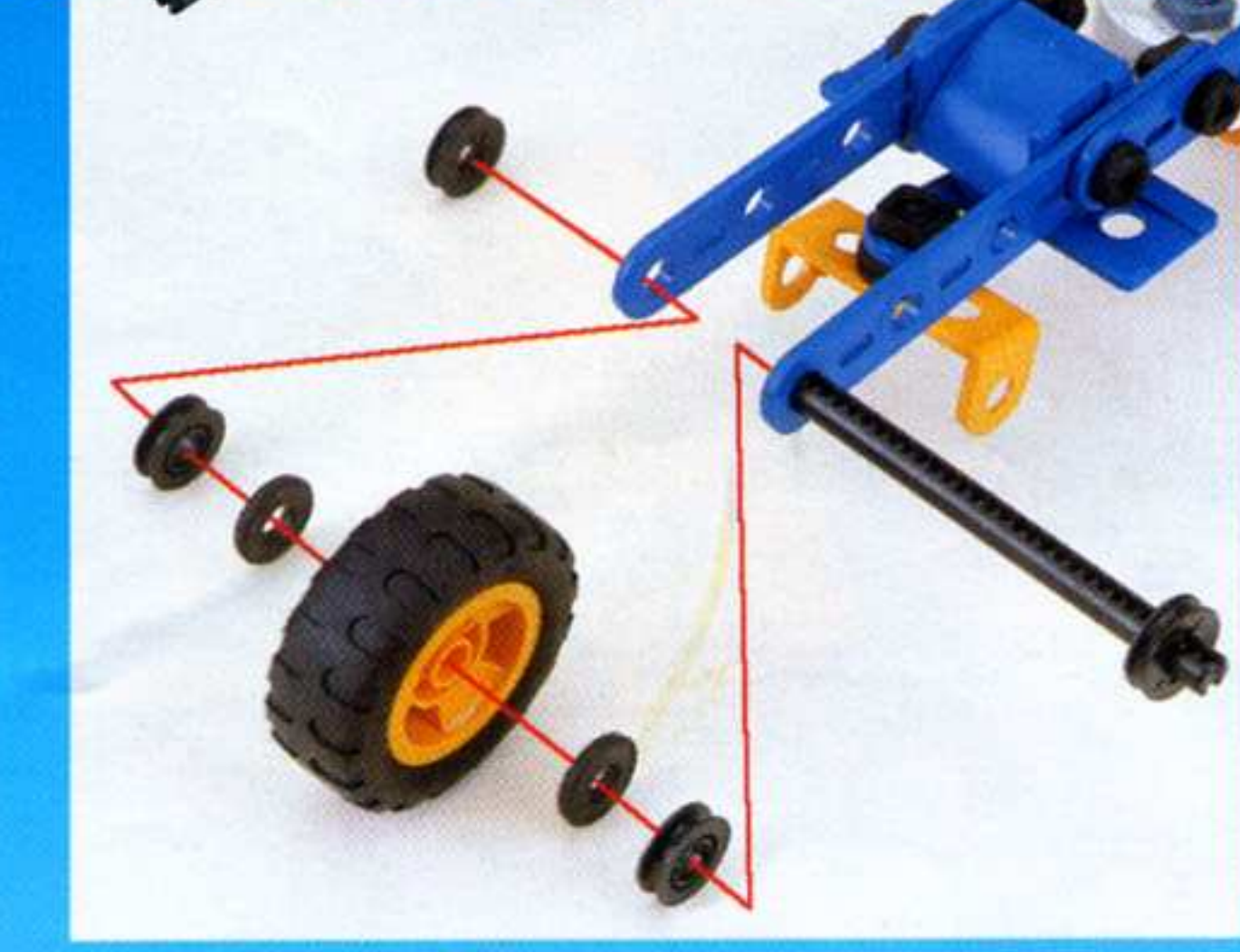

15

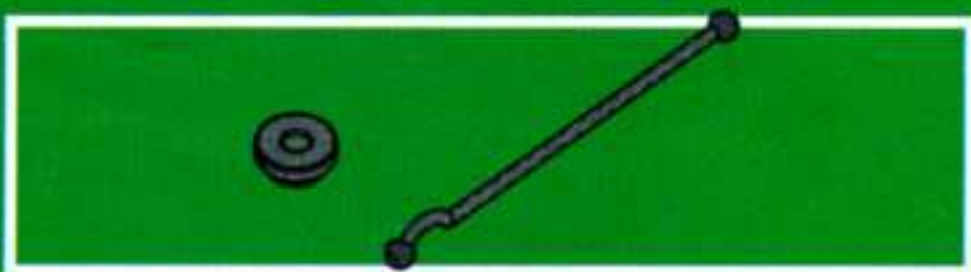

16



3



4

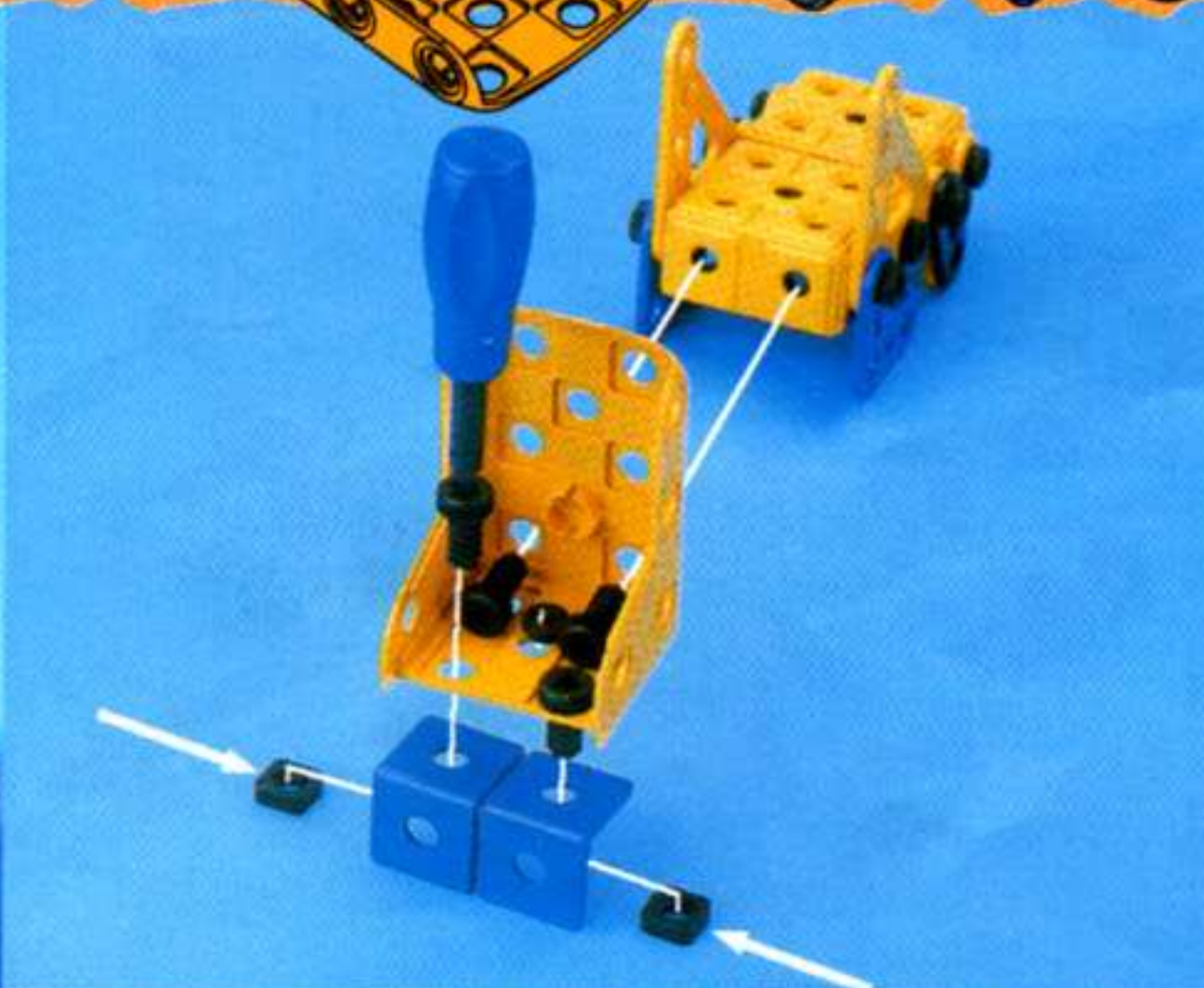

5

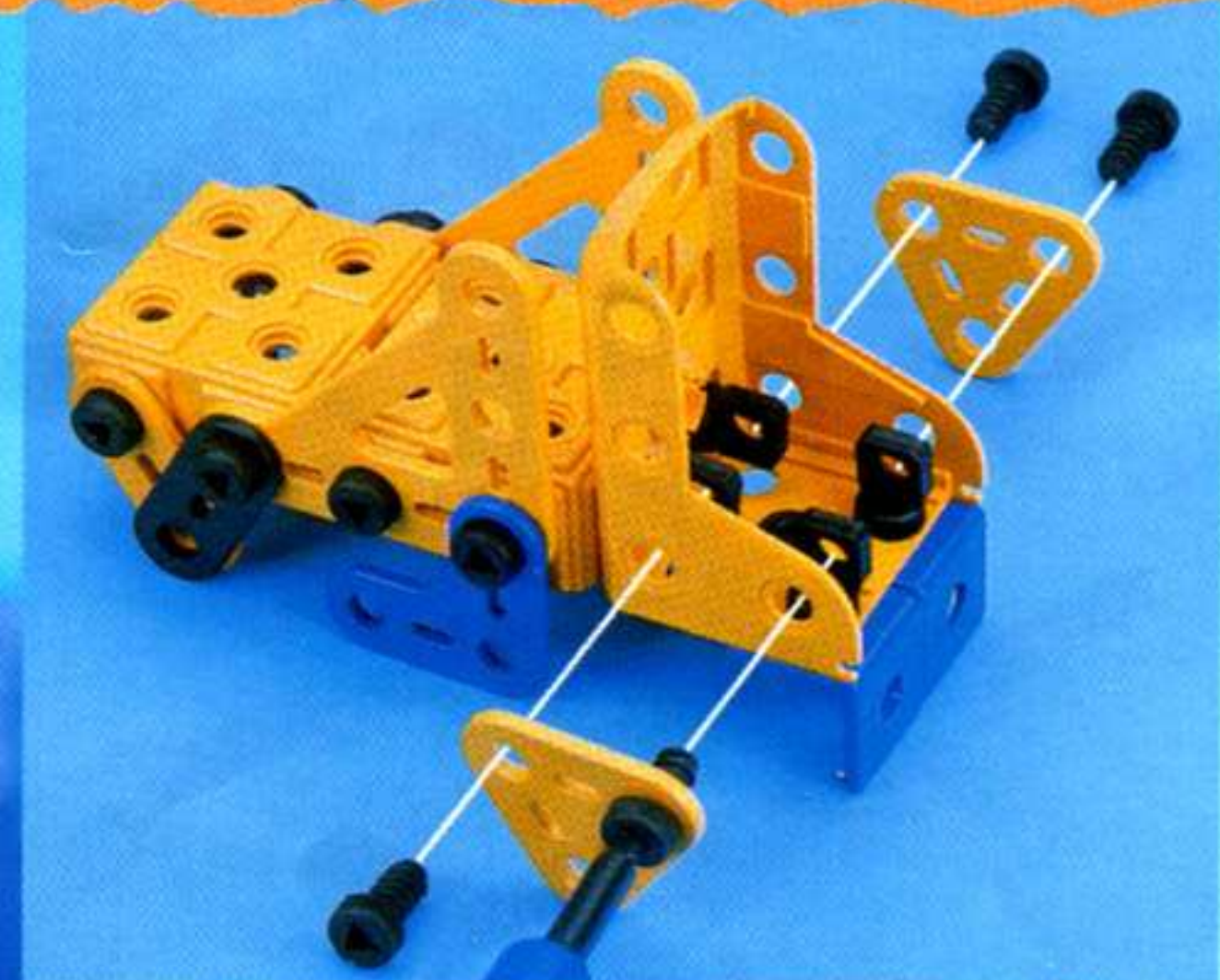

9

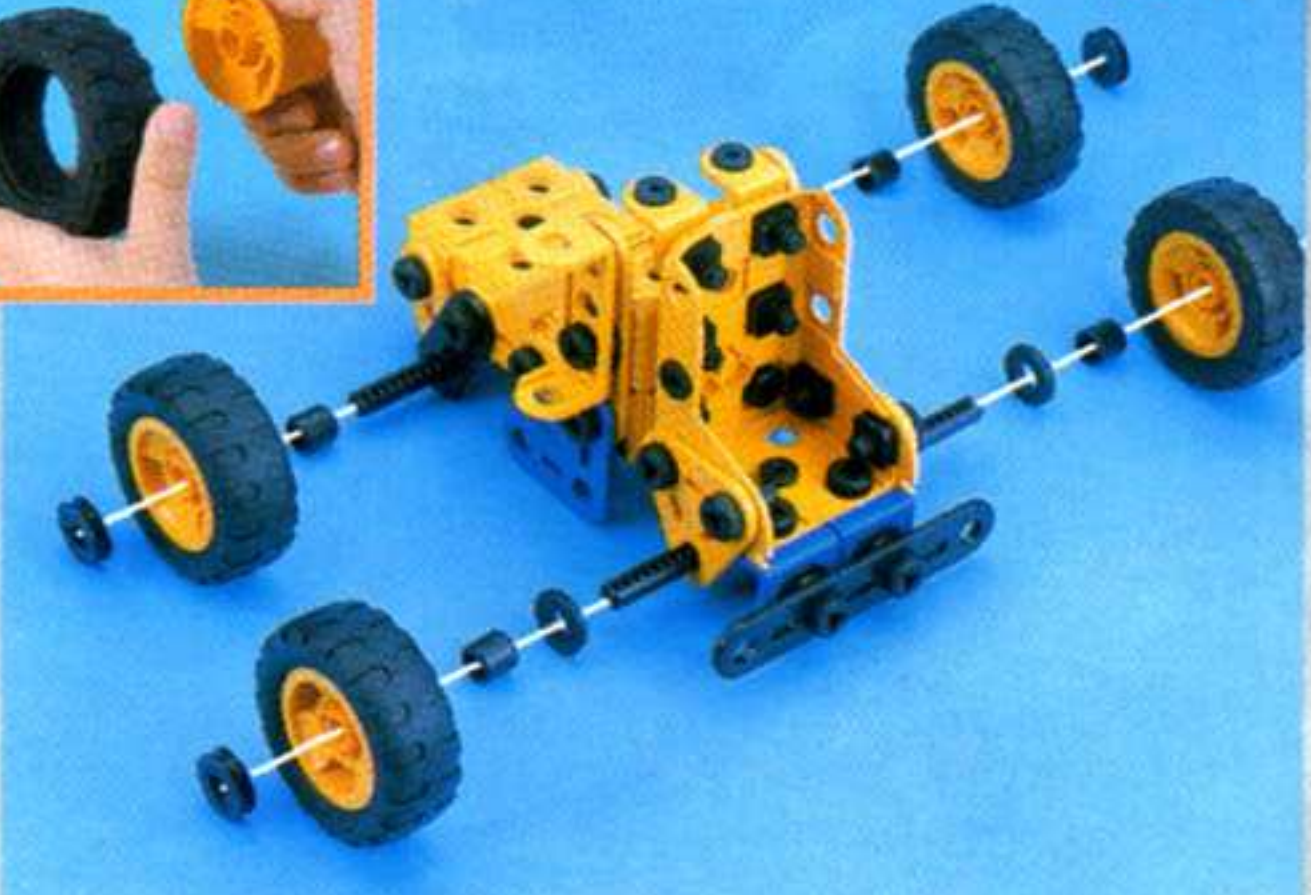

10

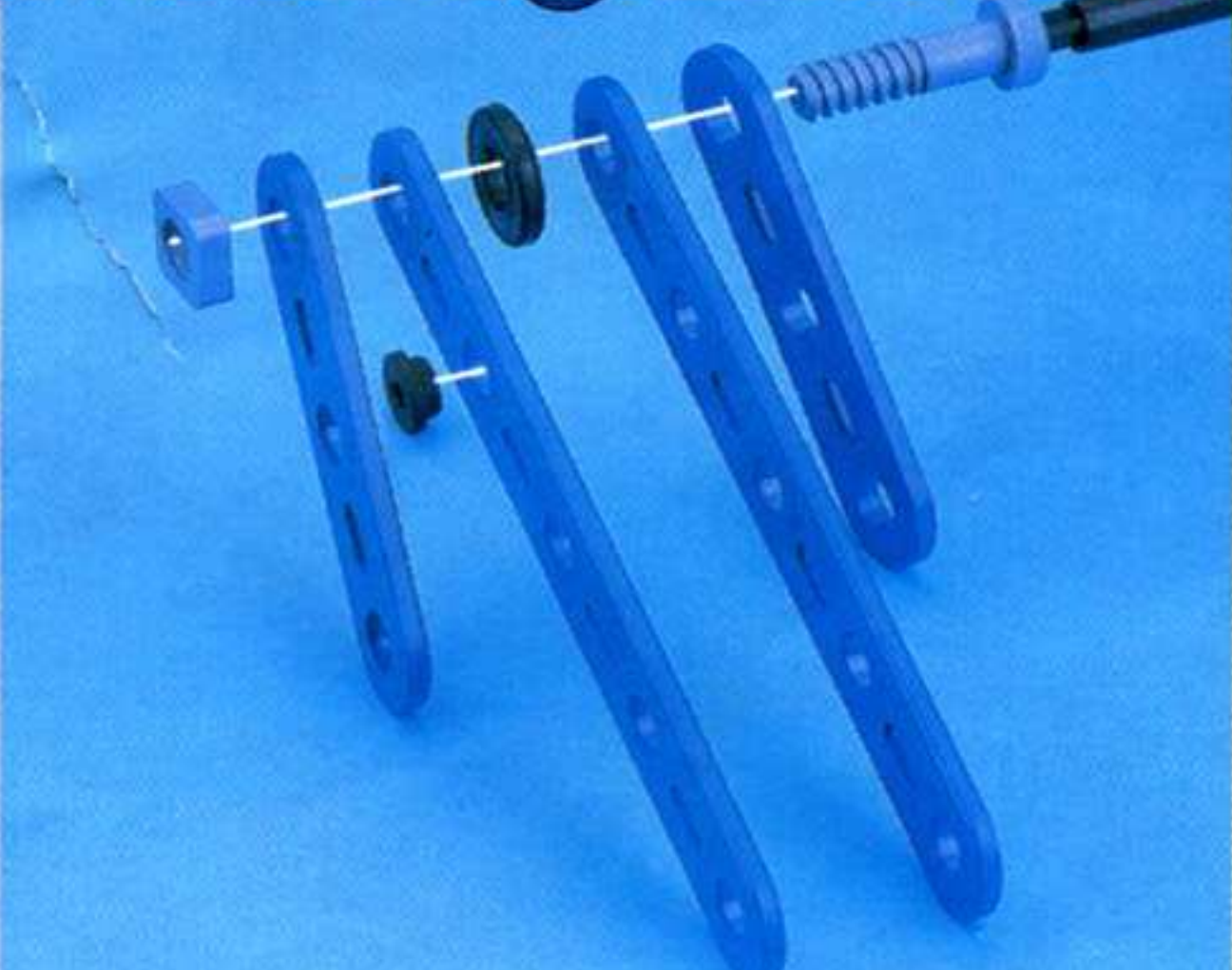

11

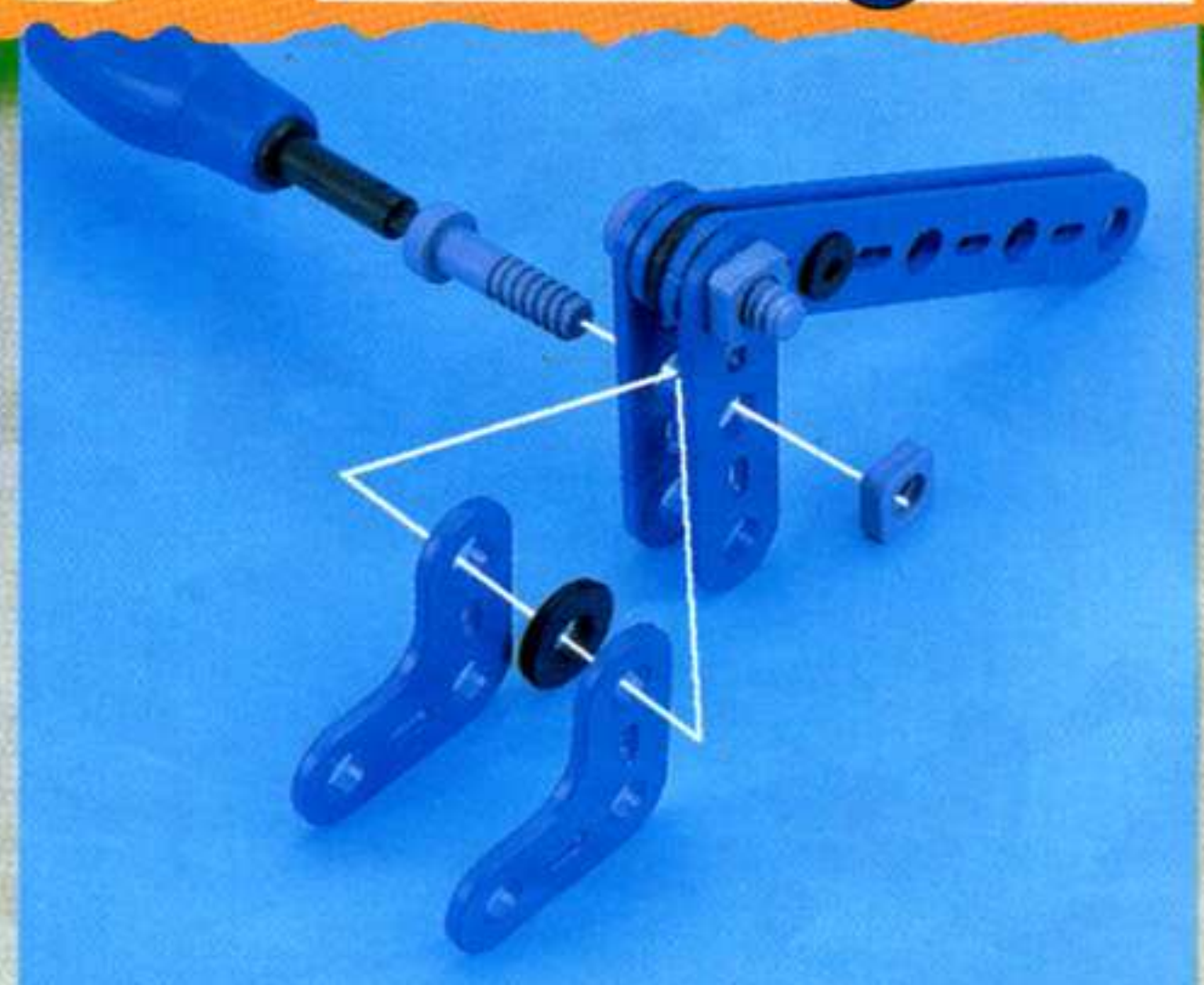

15

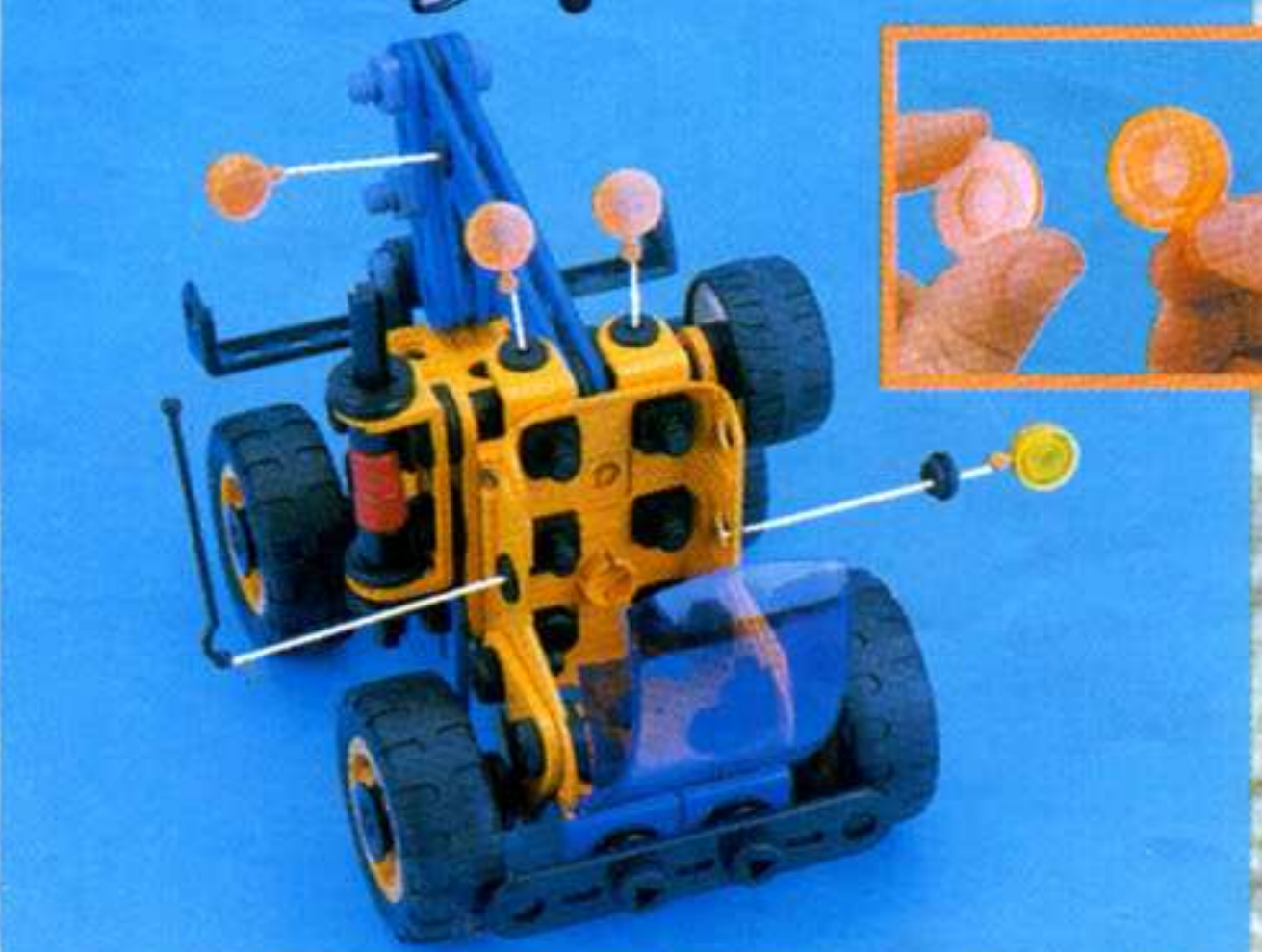

13

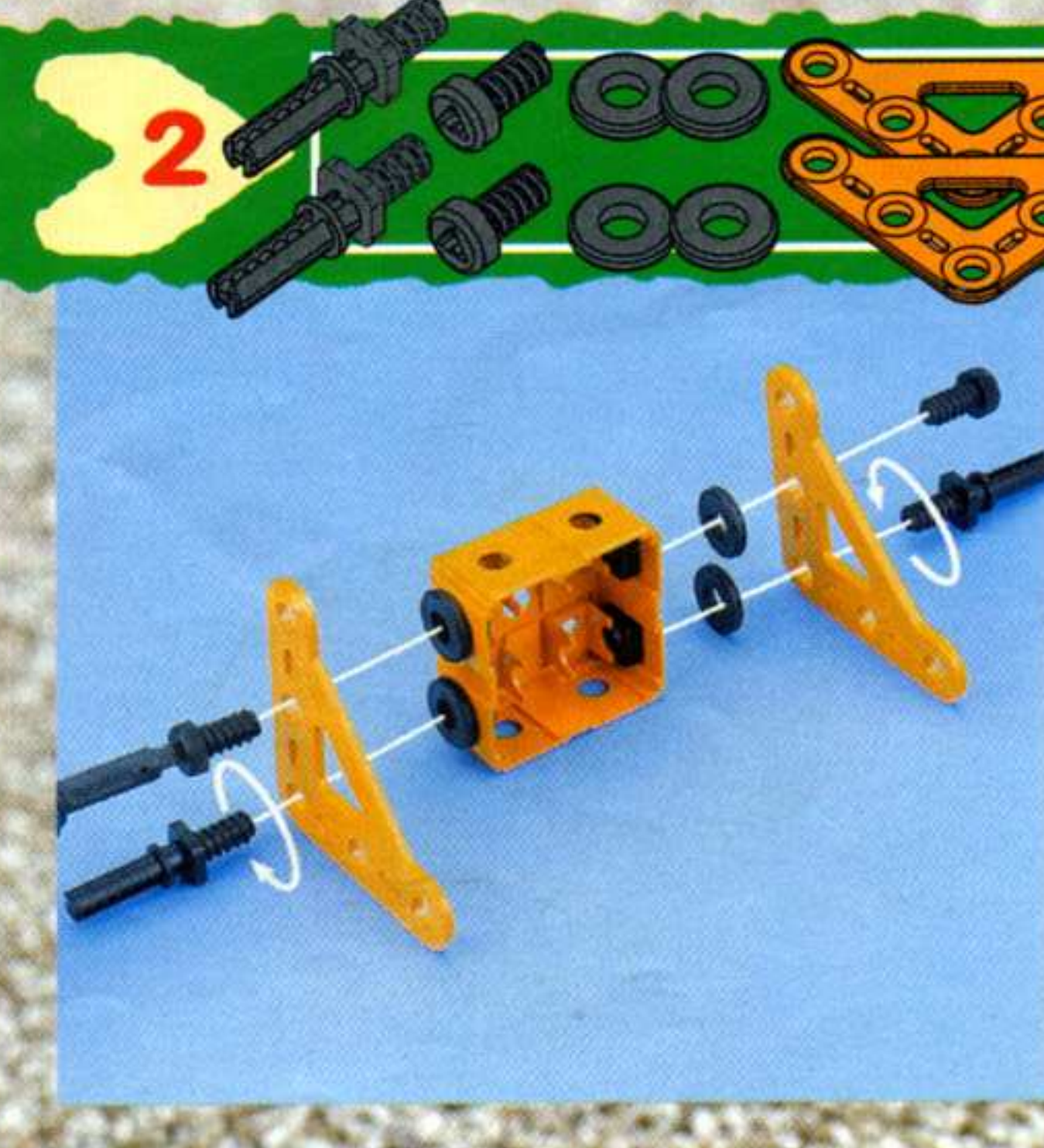
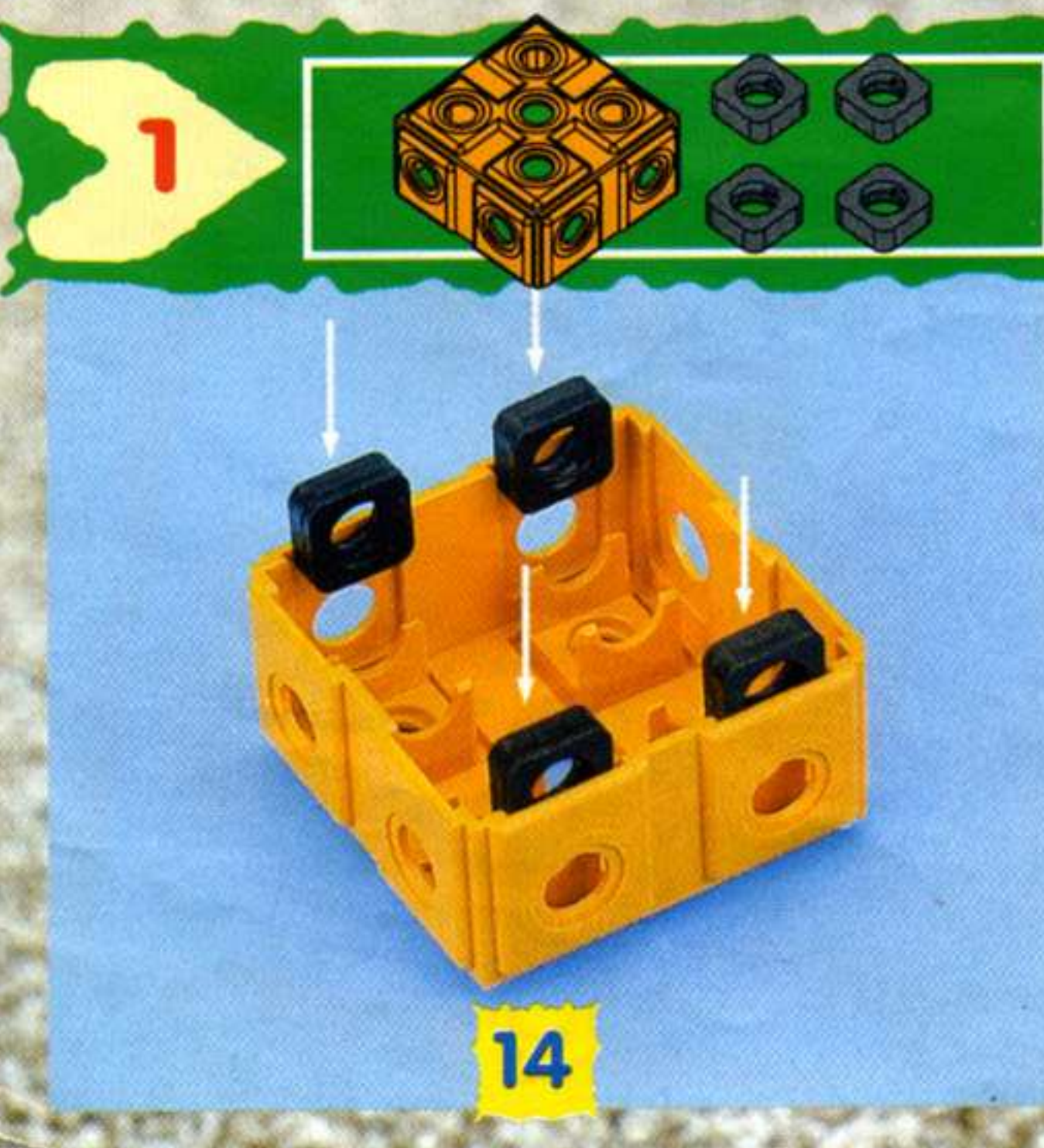
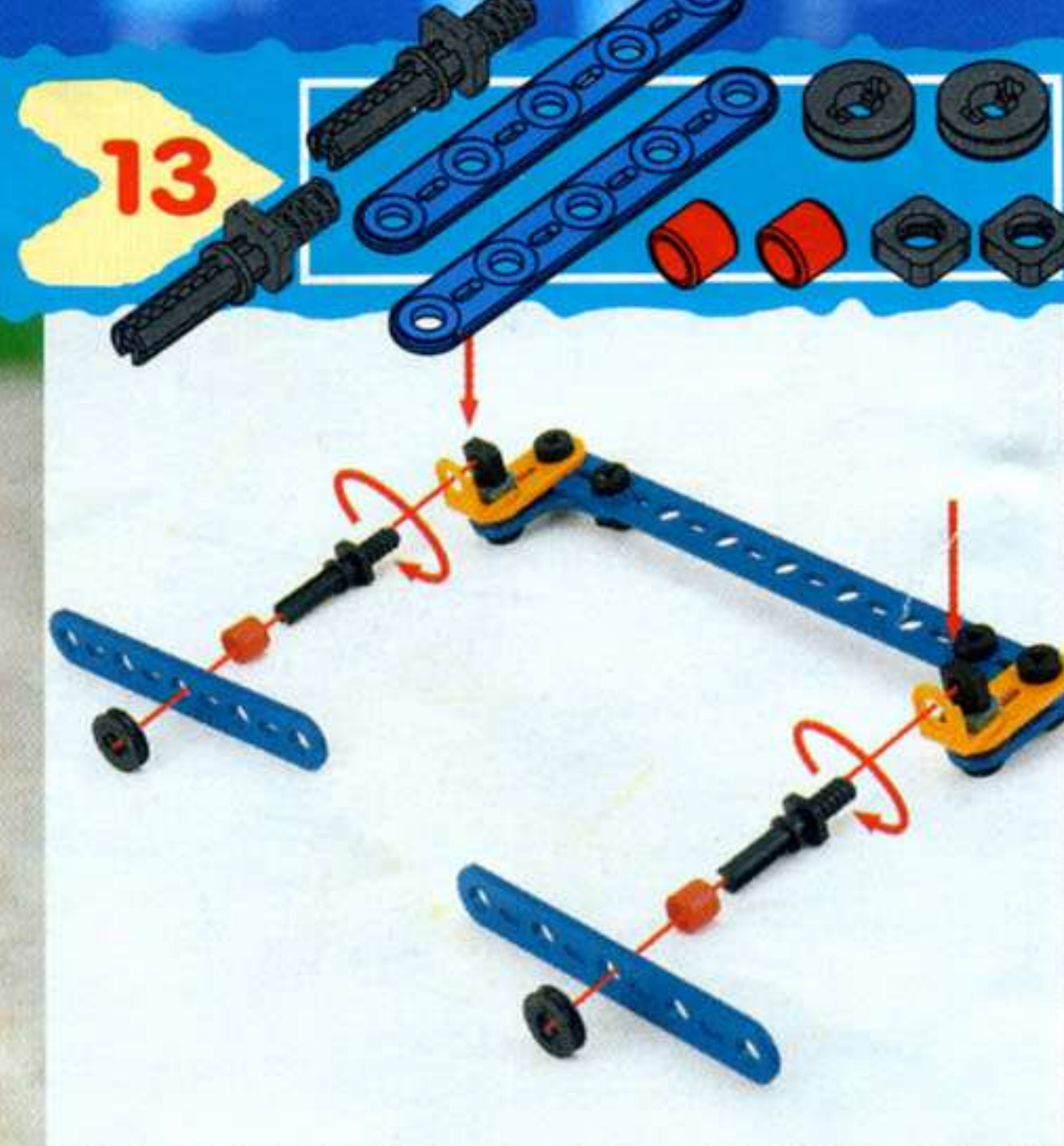
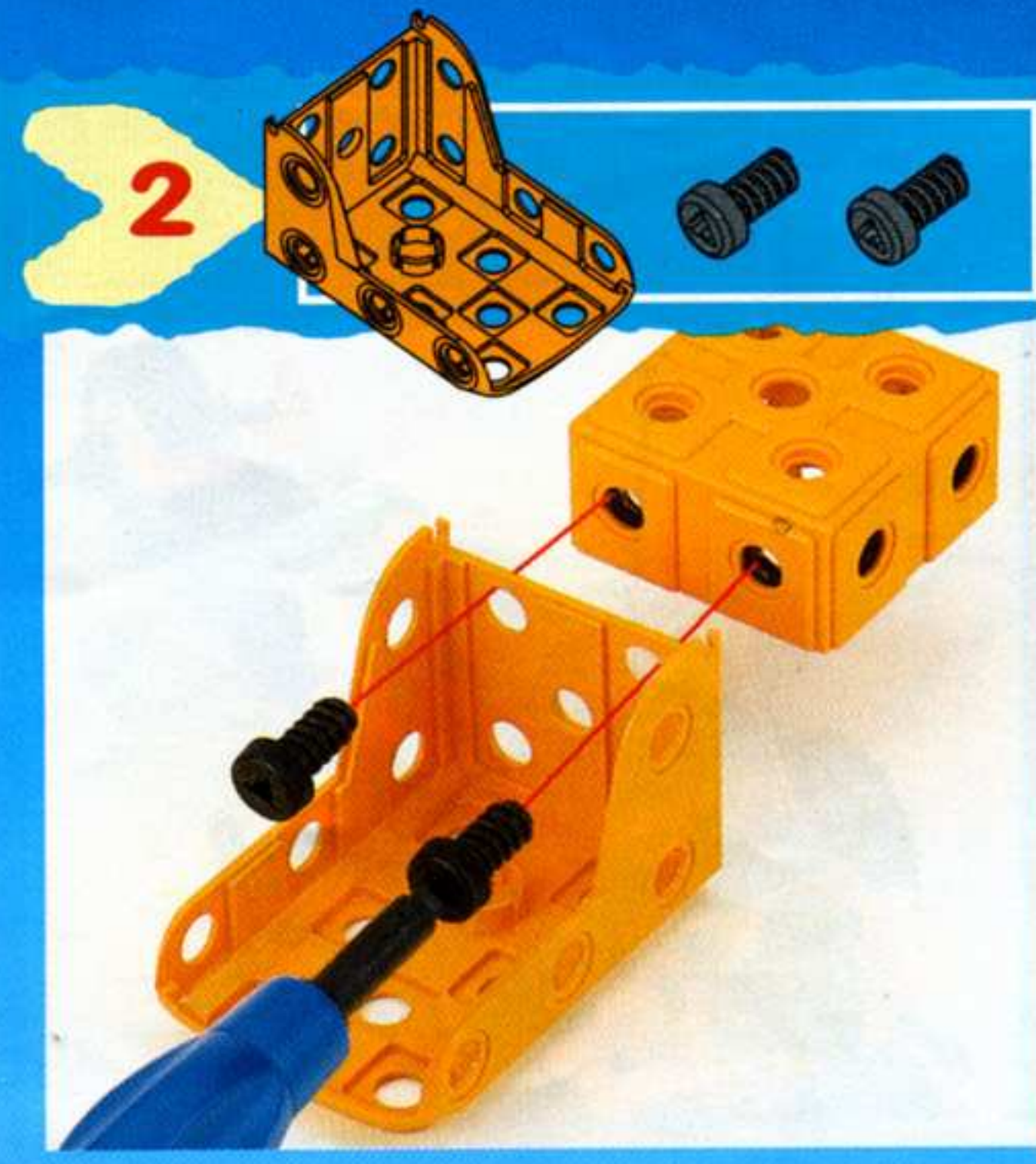
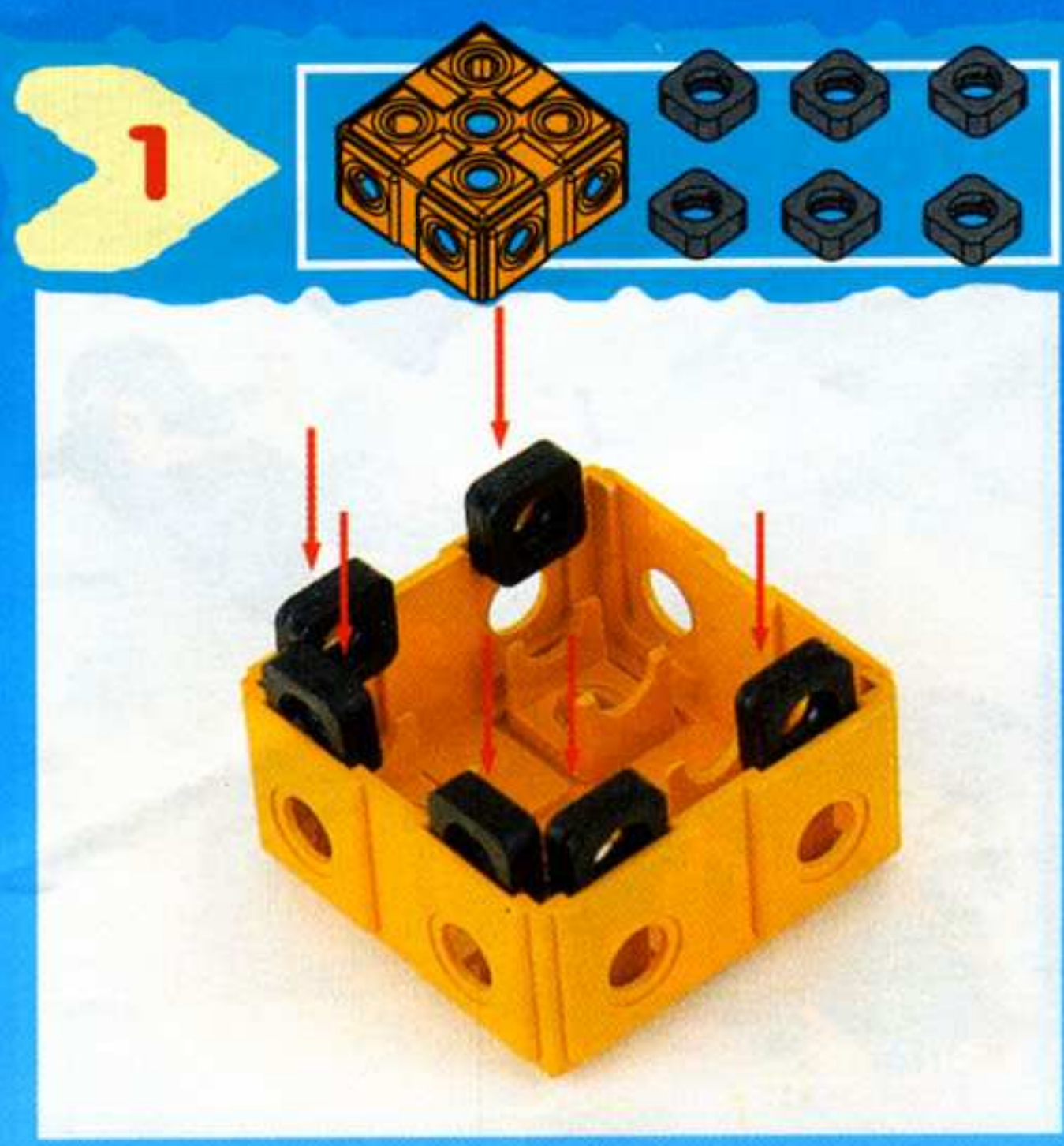

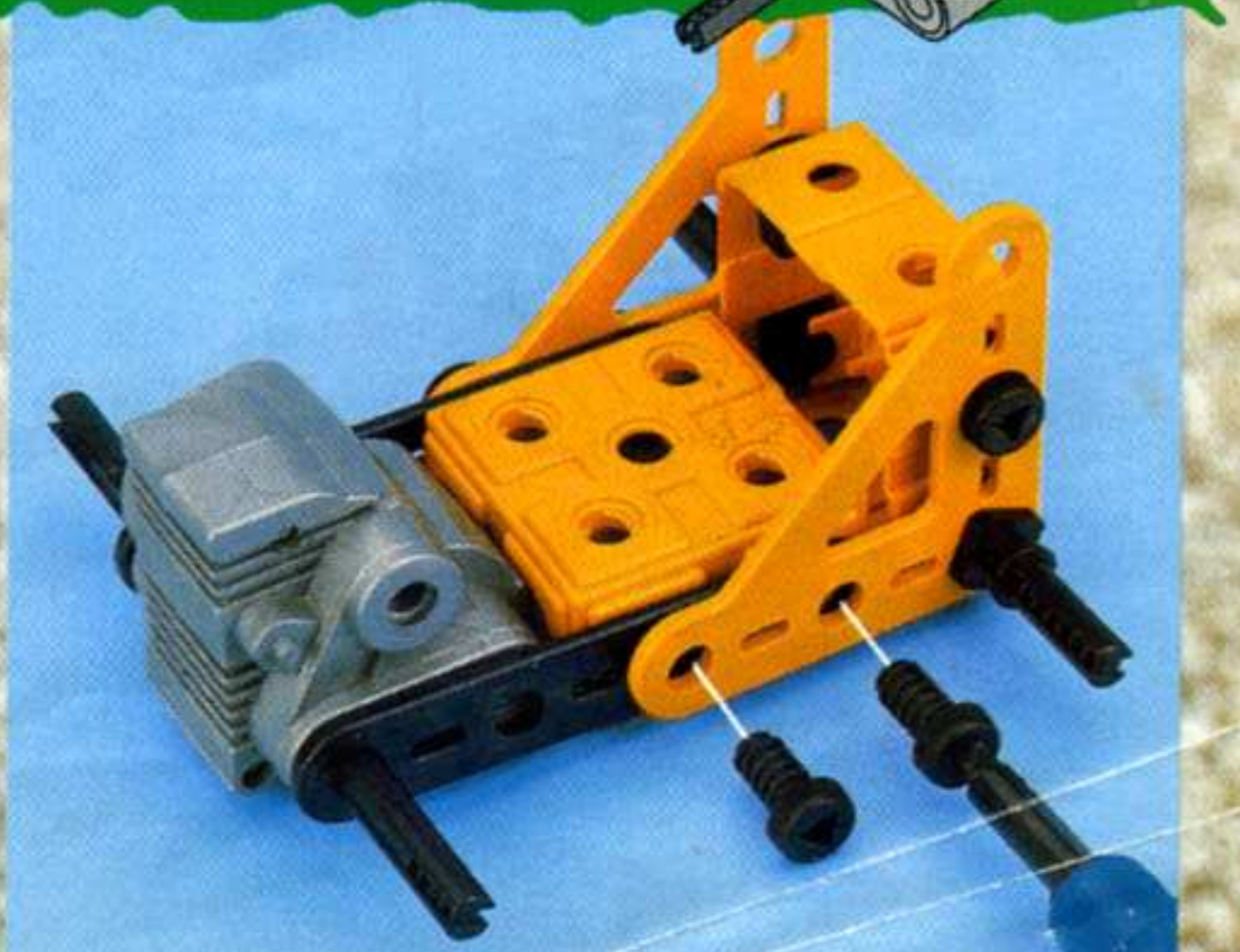
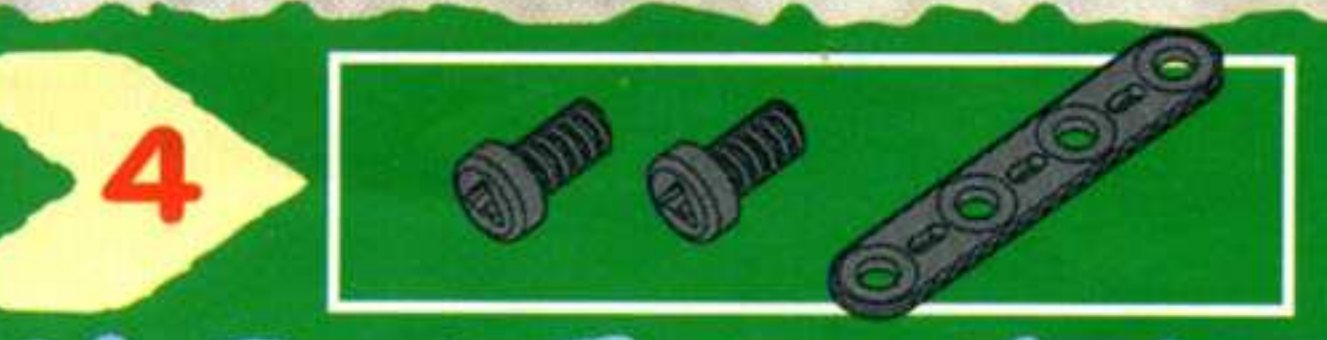
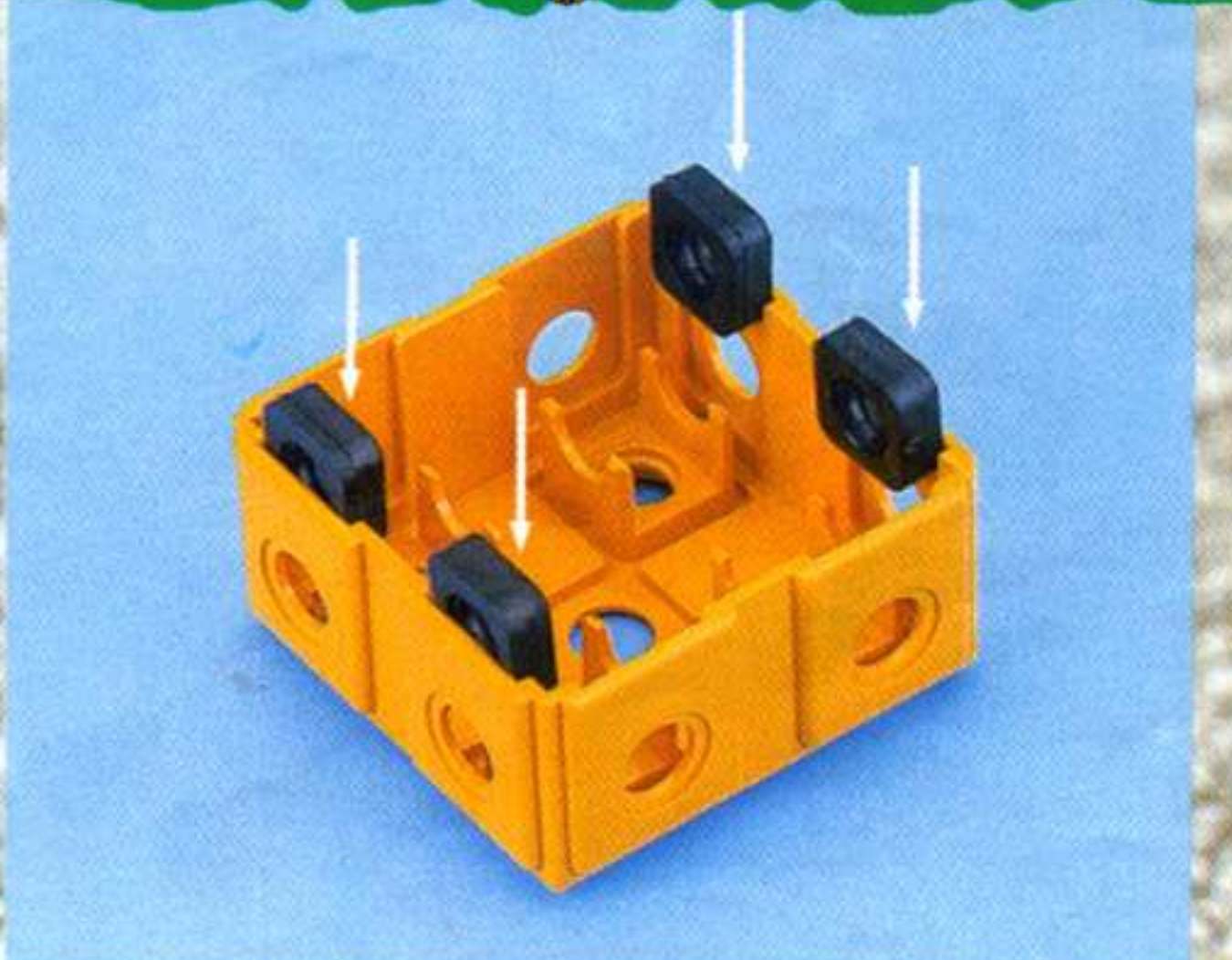
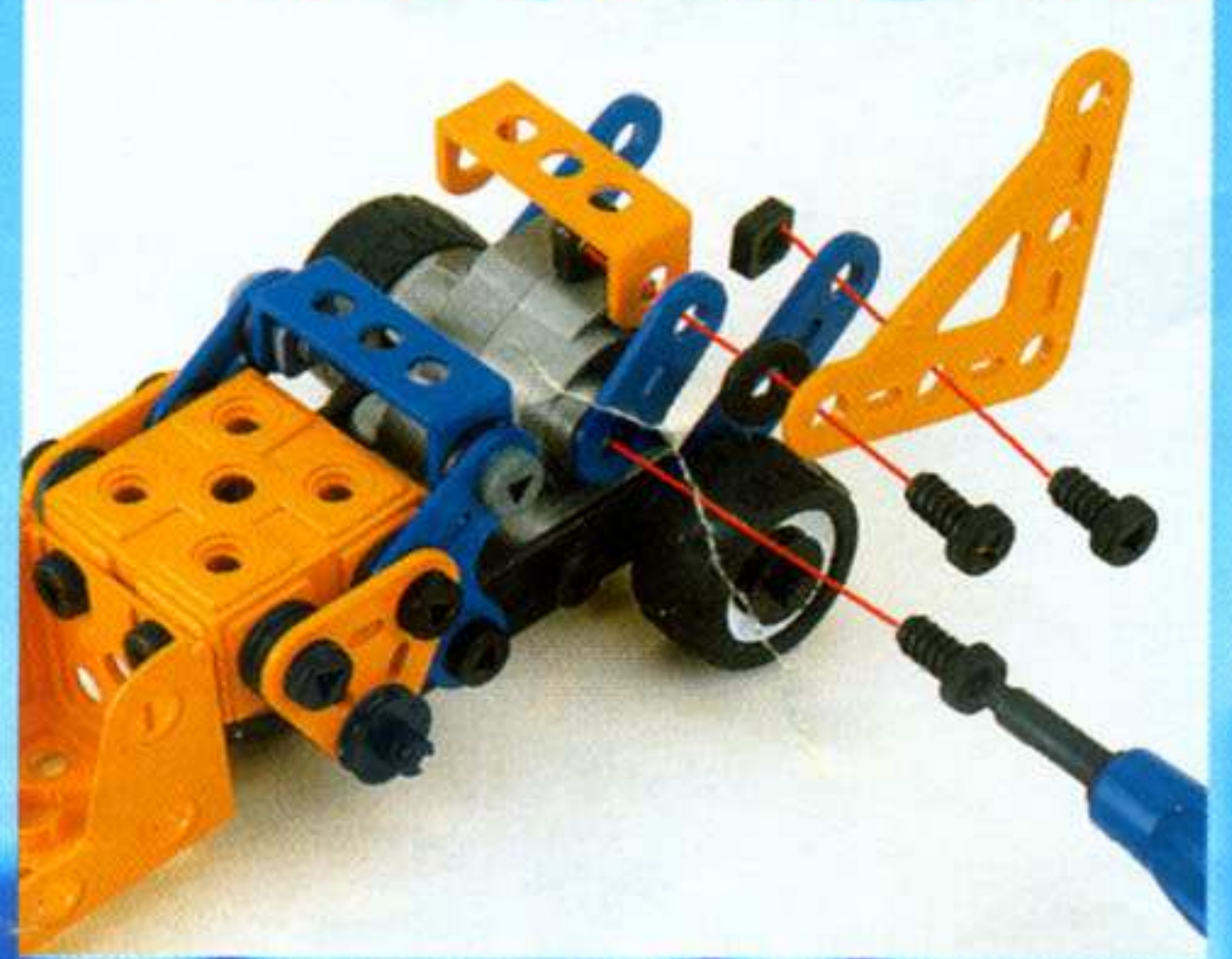
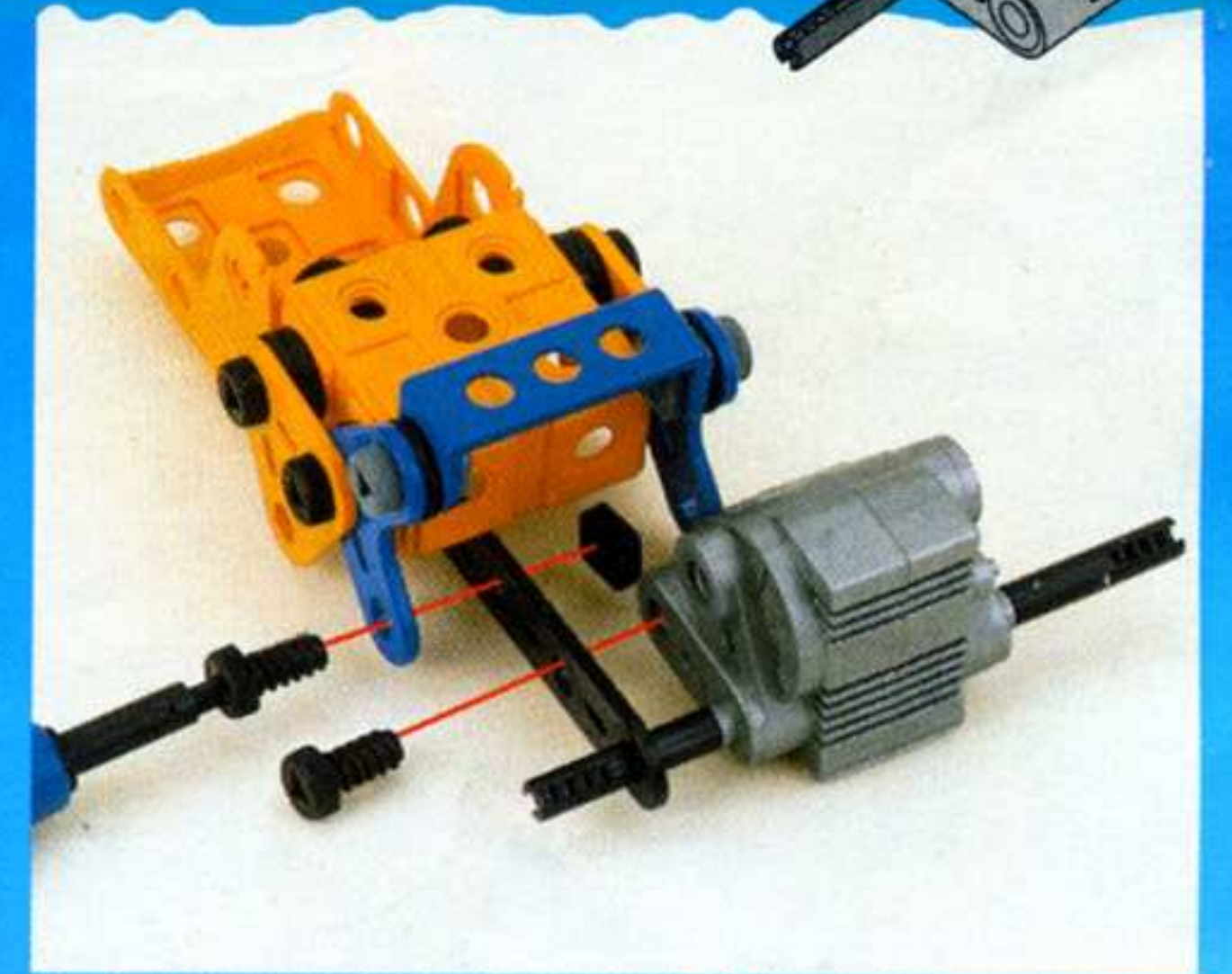
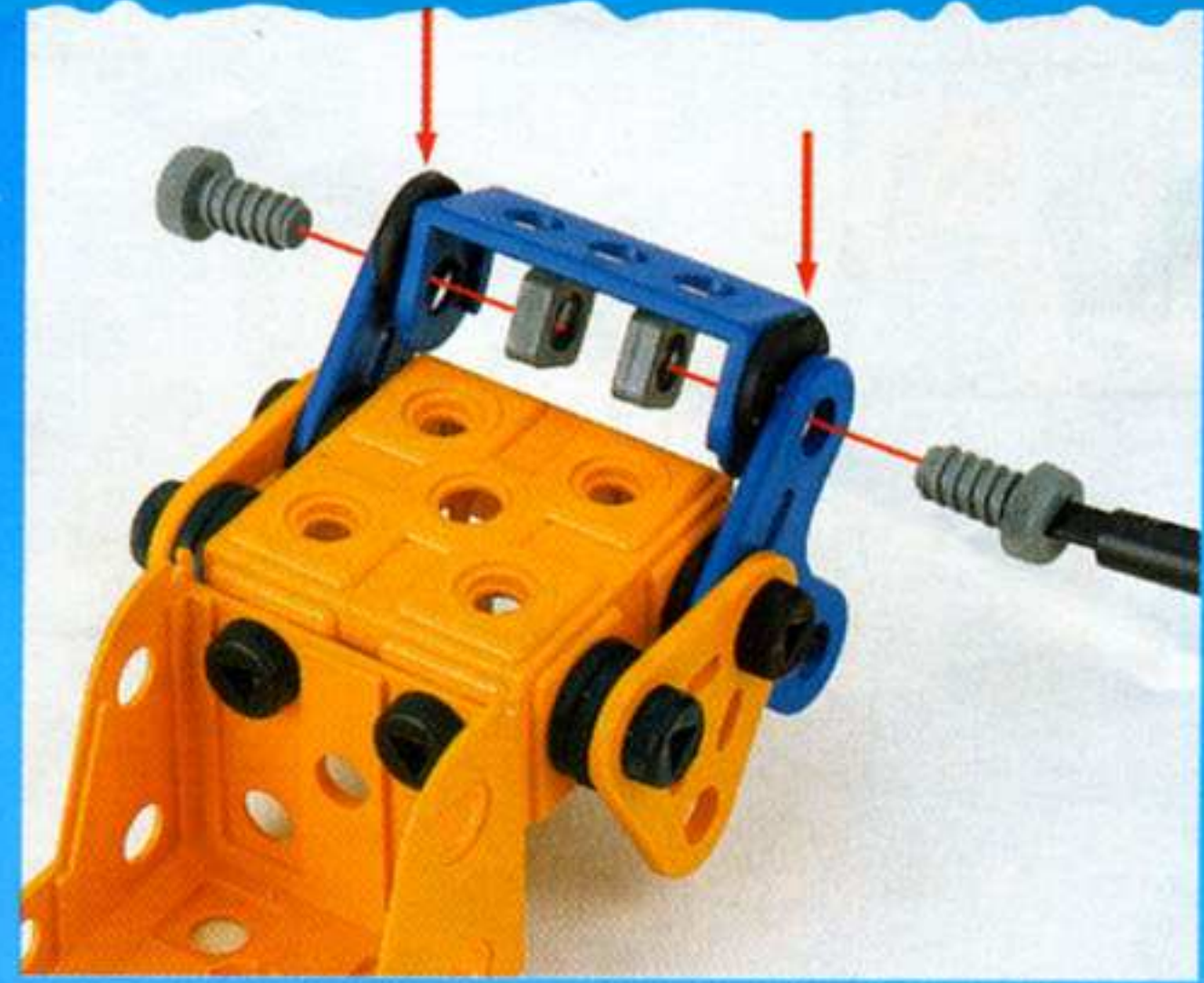
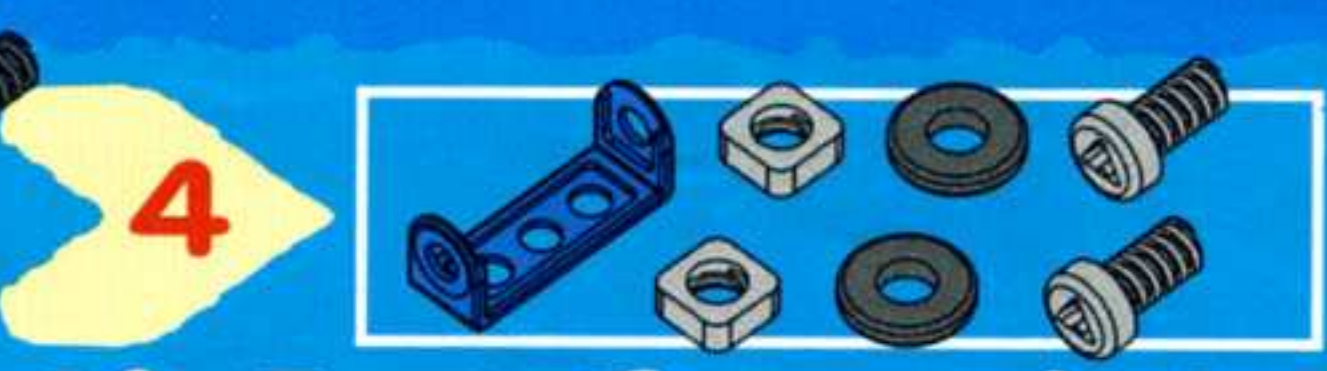

6



7

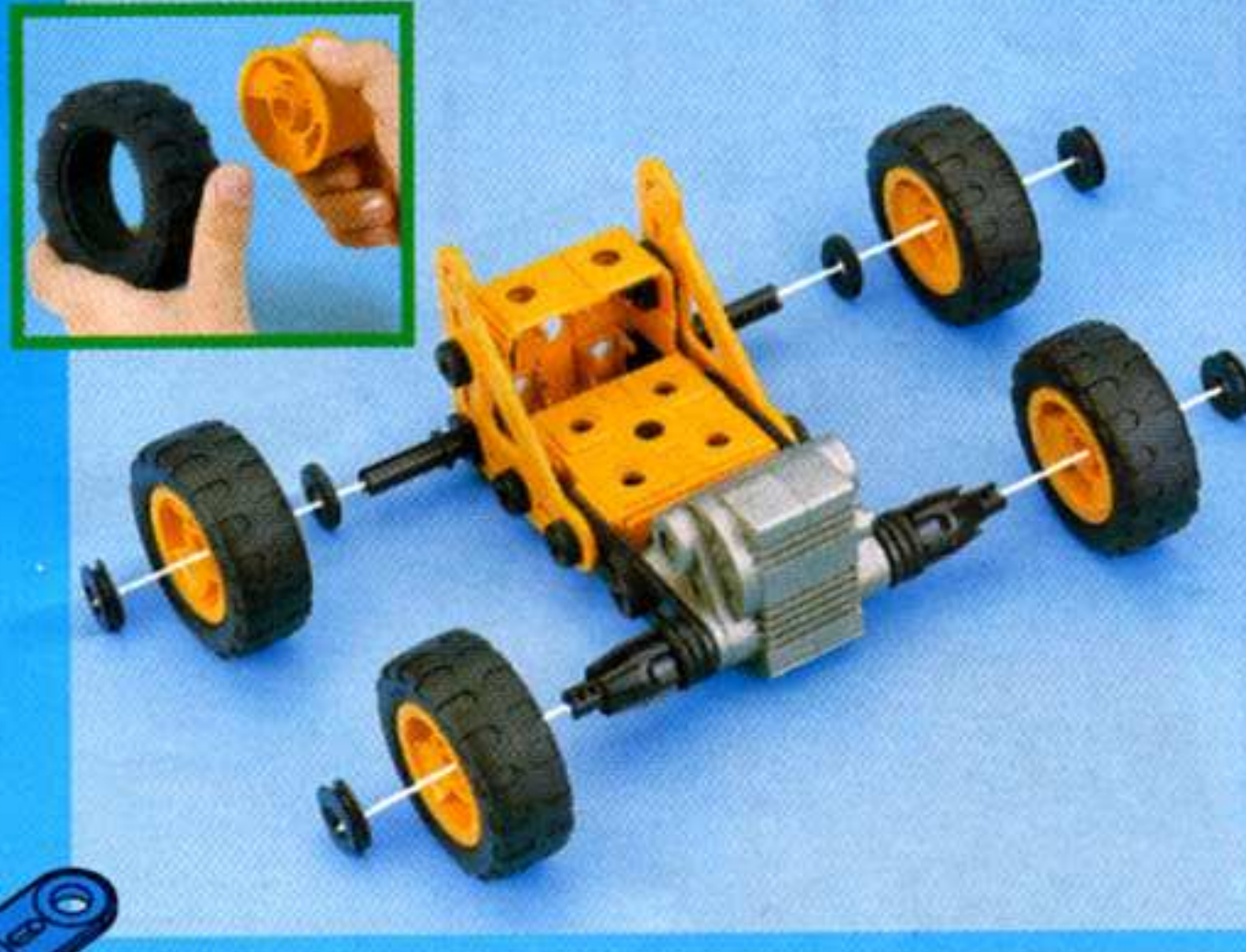

8

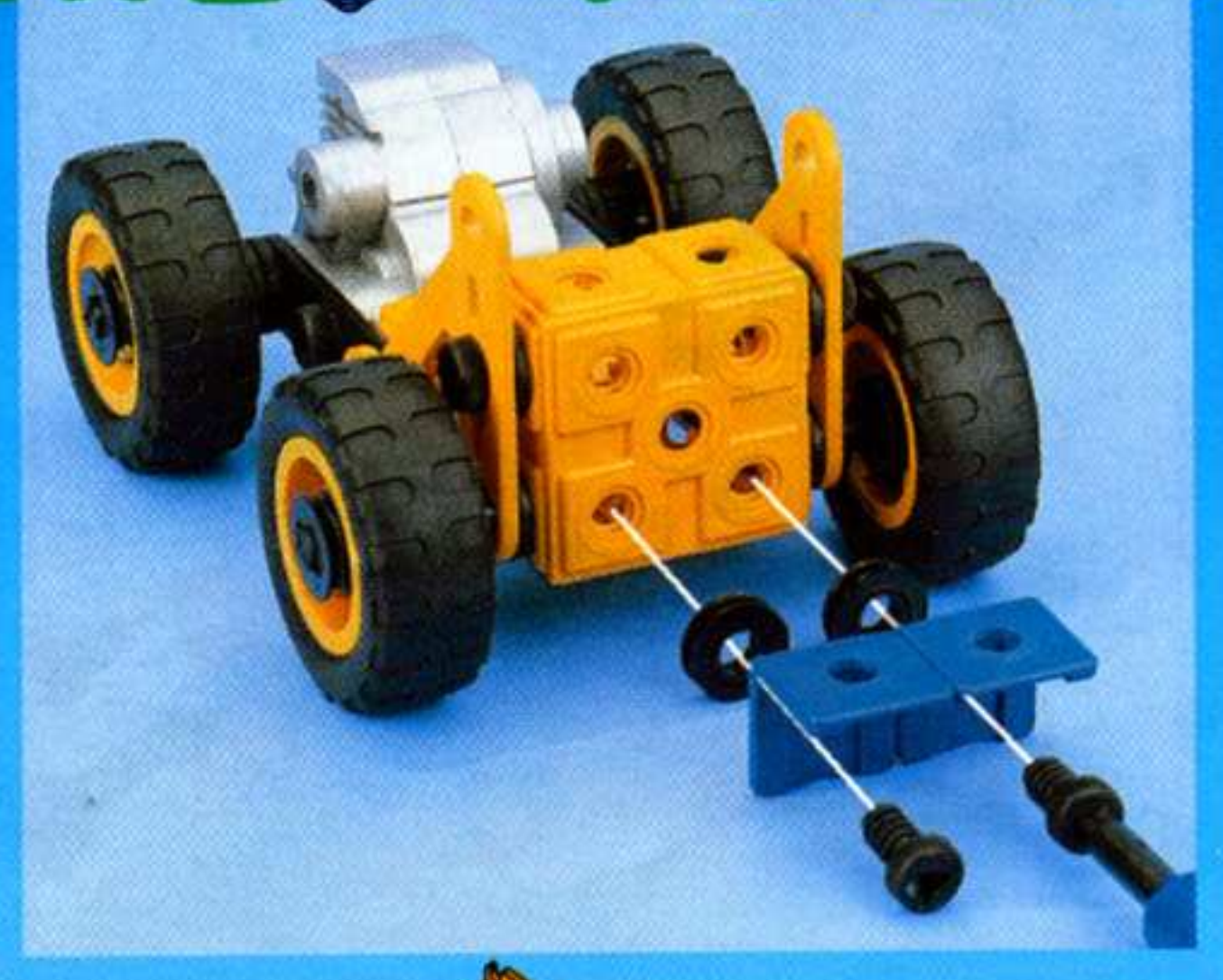
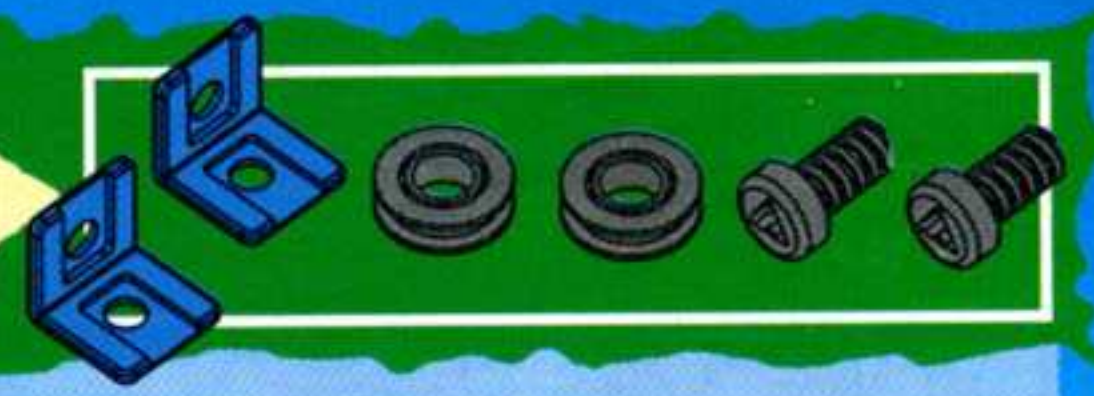

12

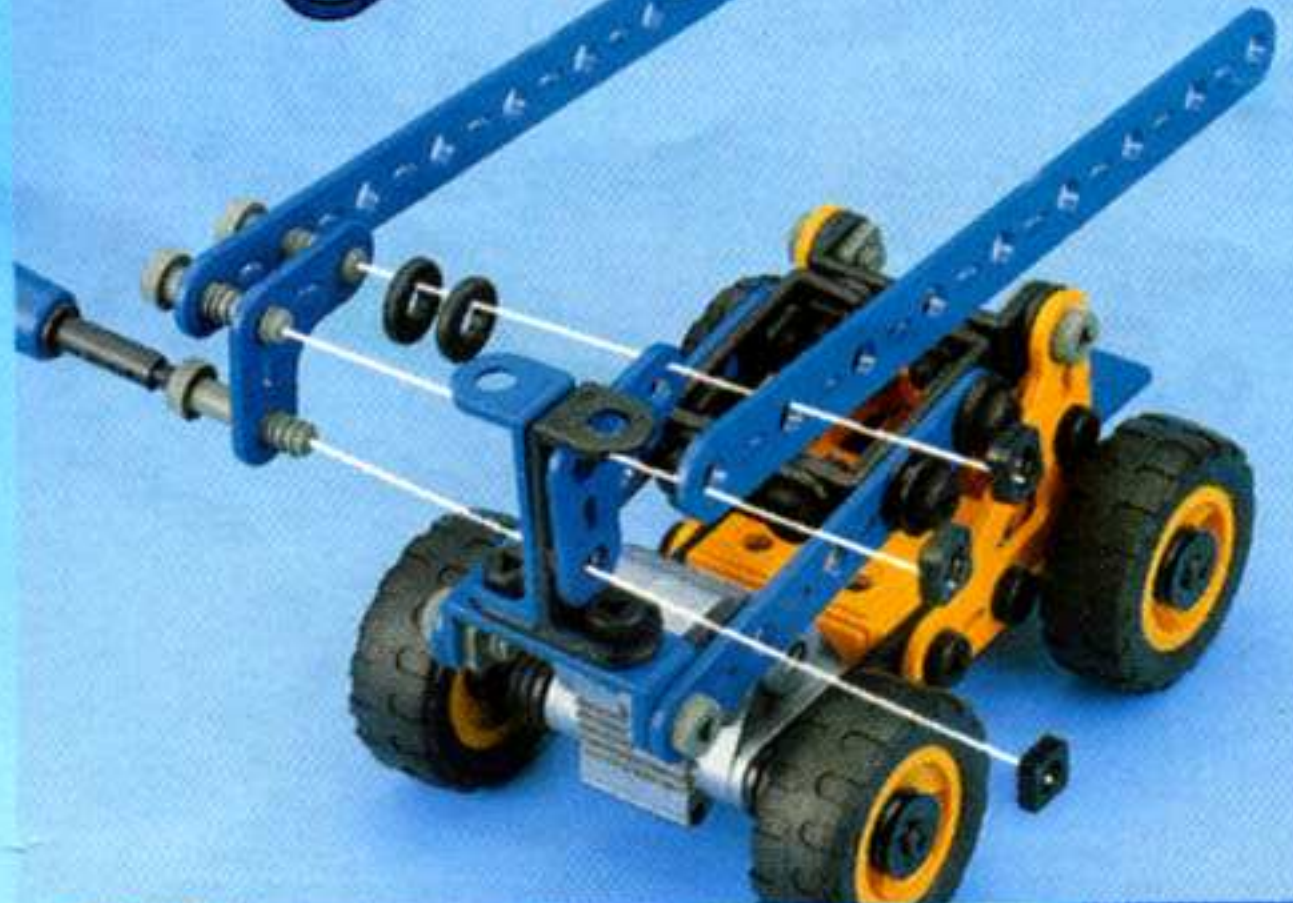
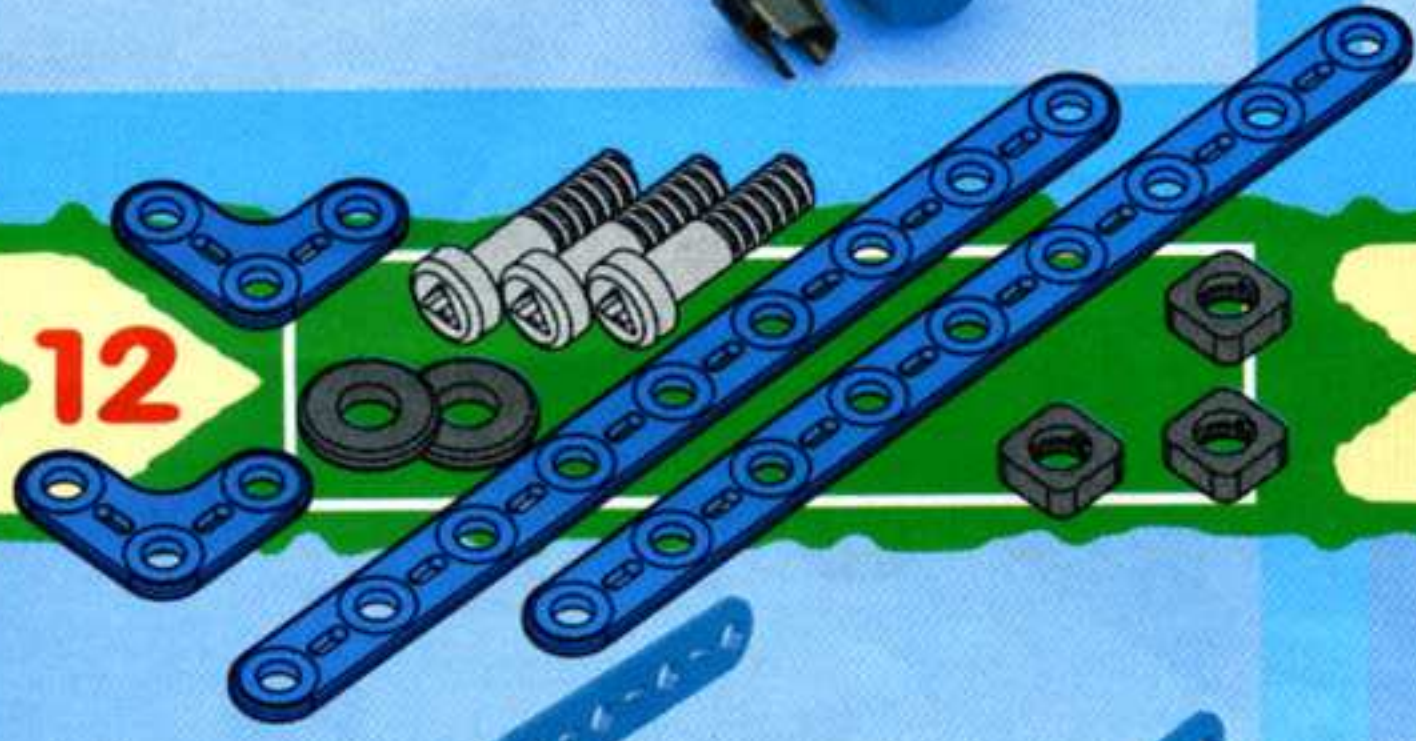

13

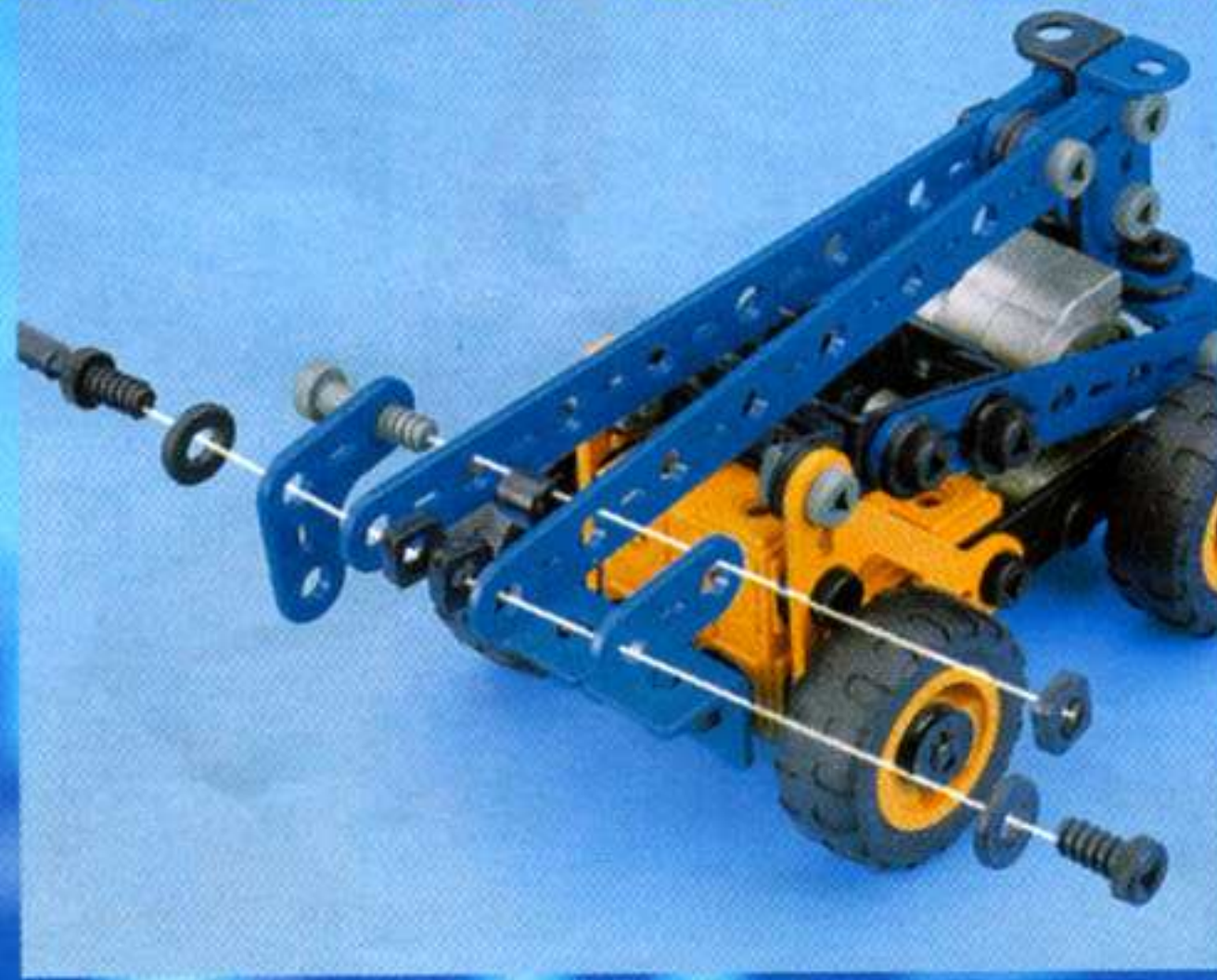

14

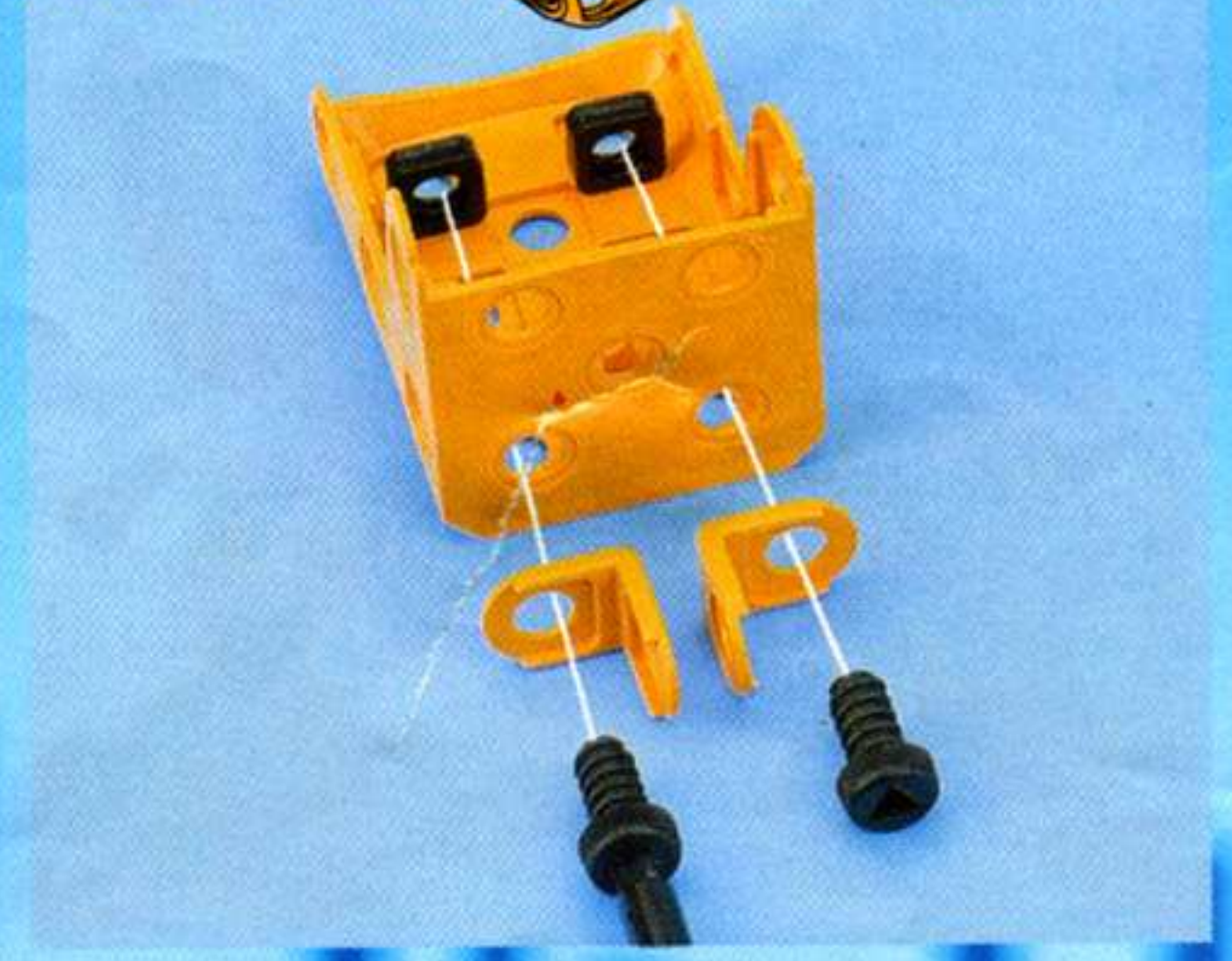

1

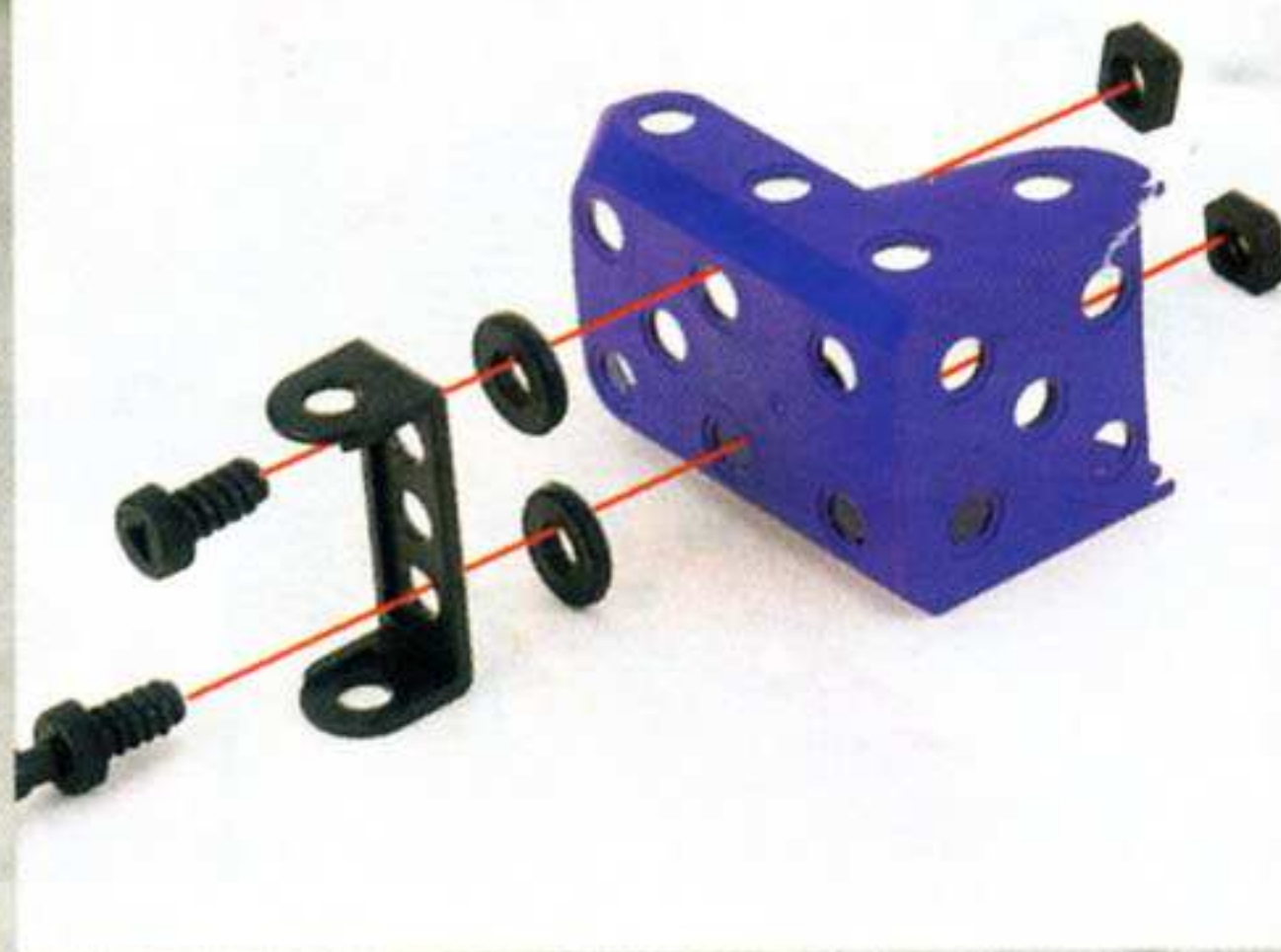

2

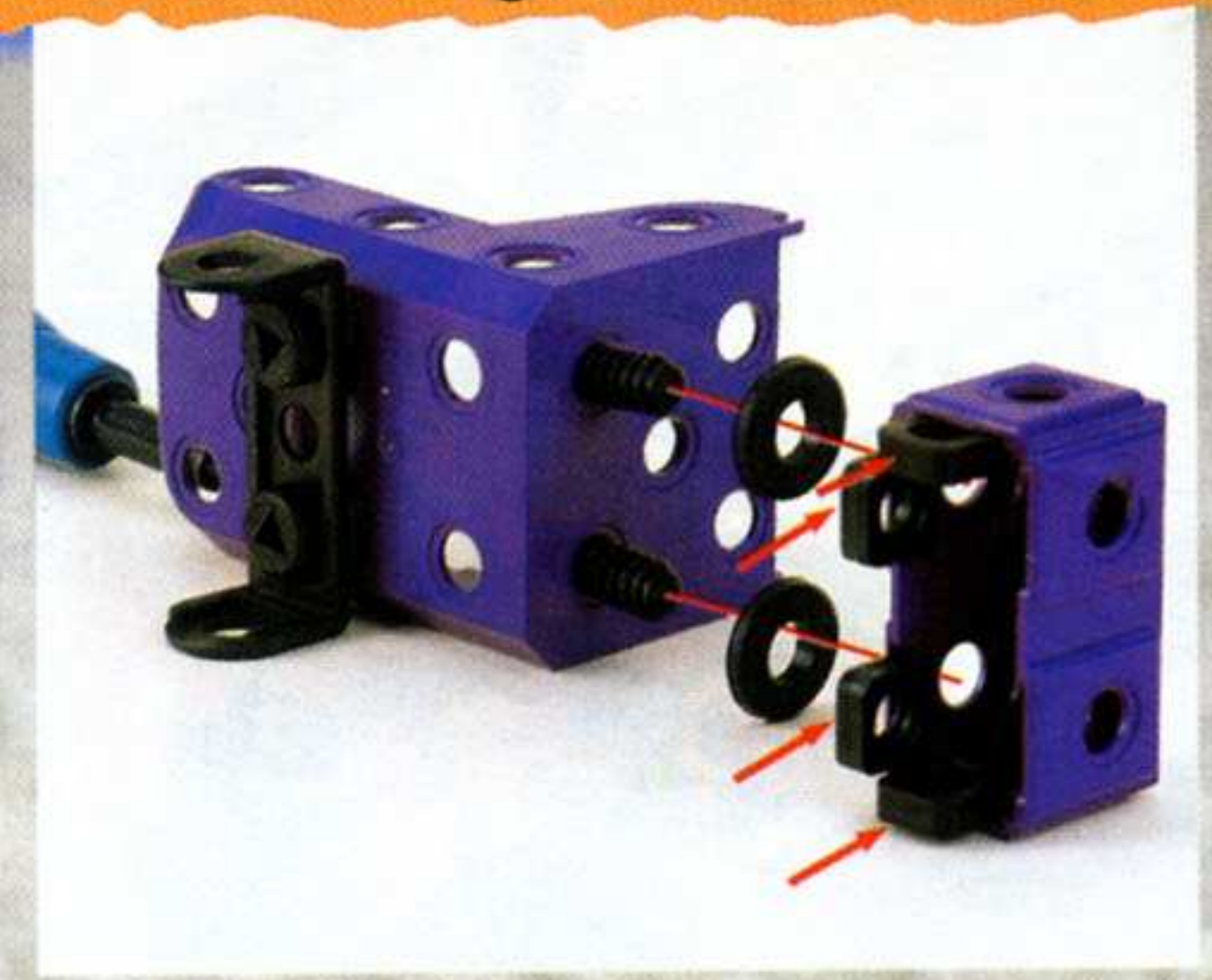

6

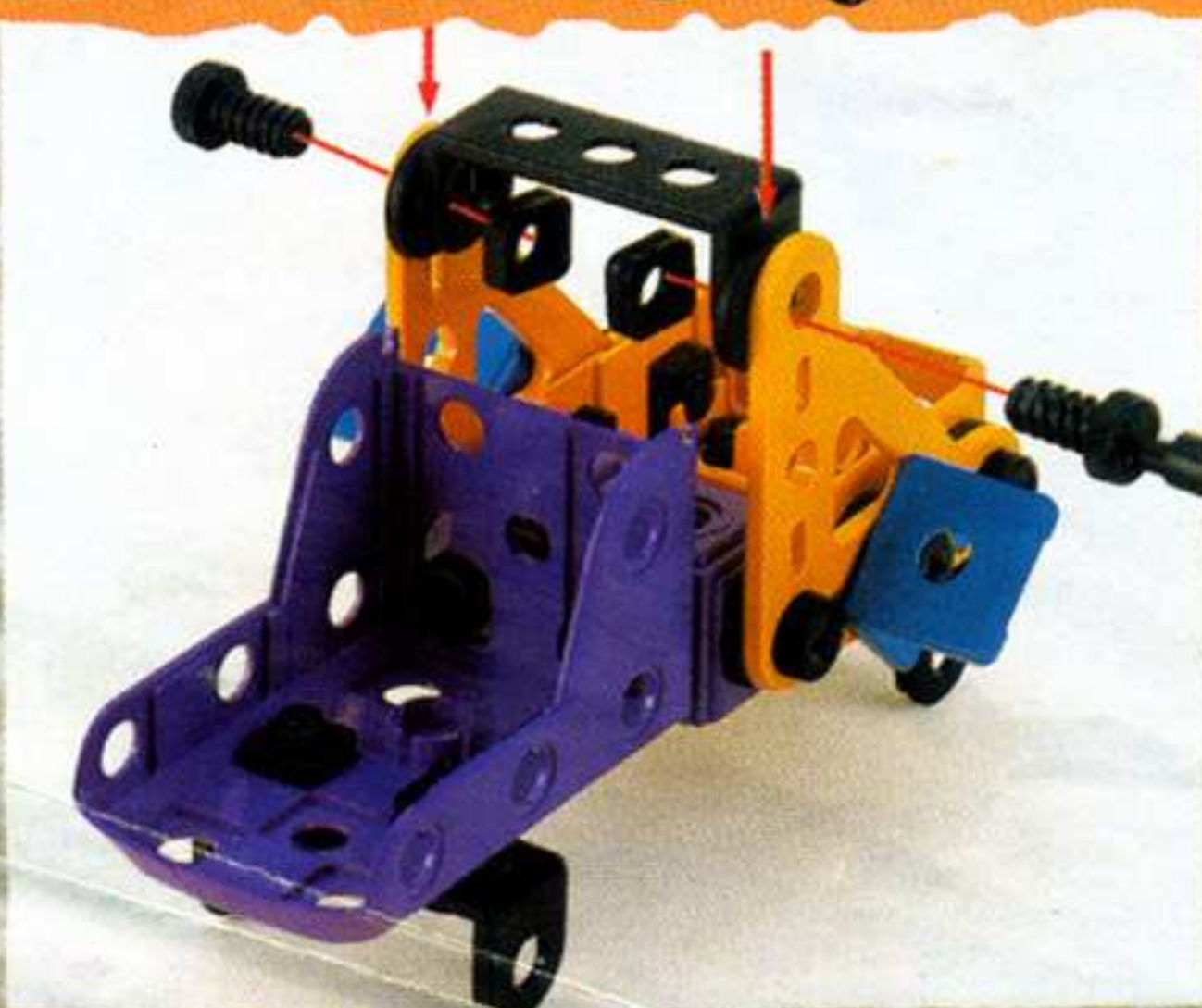

7

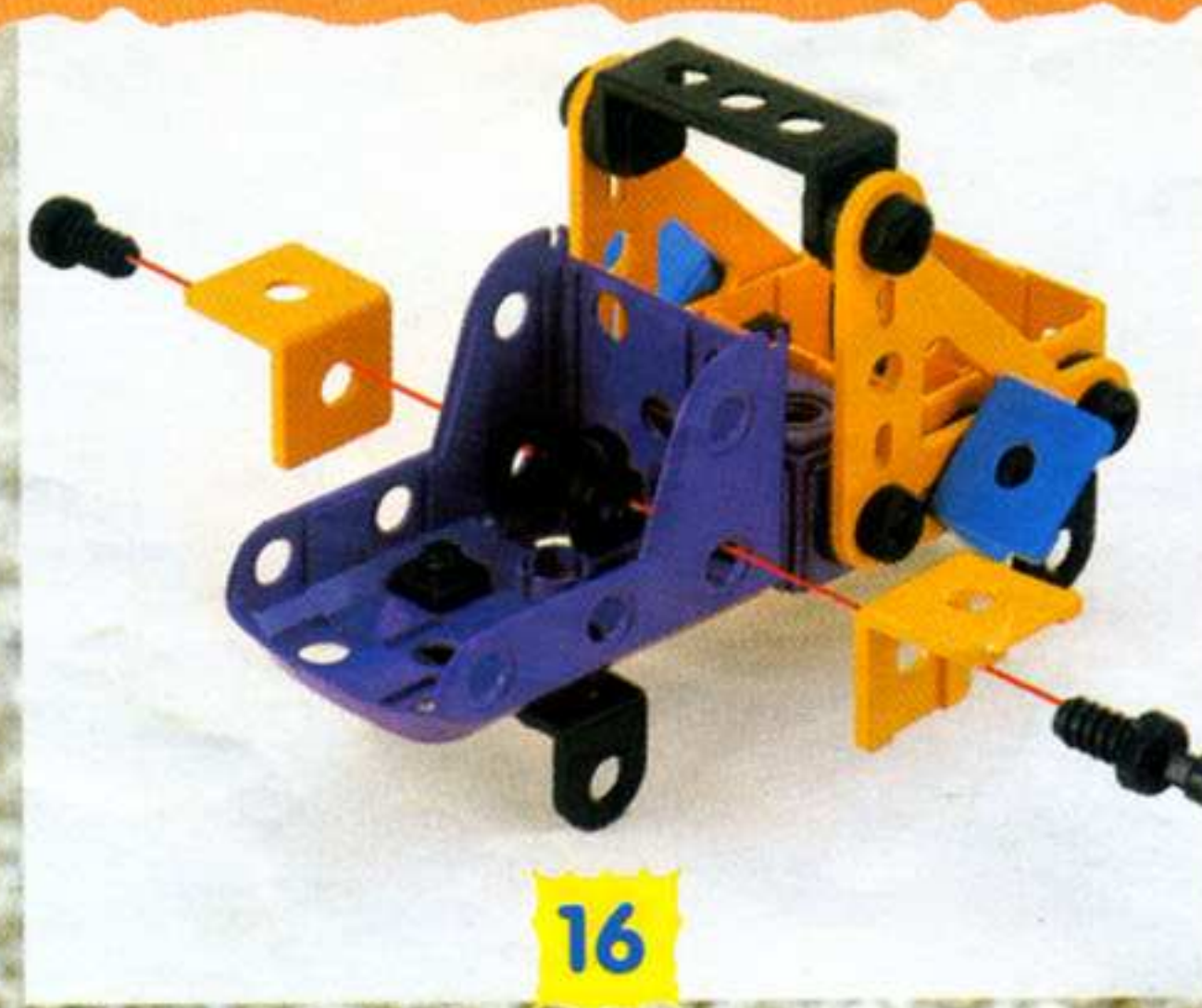

8





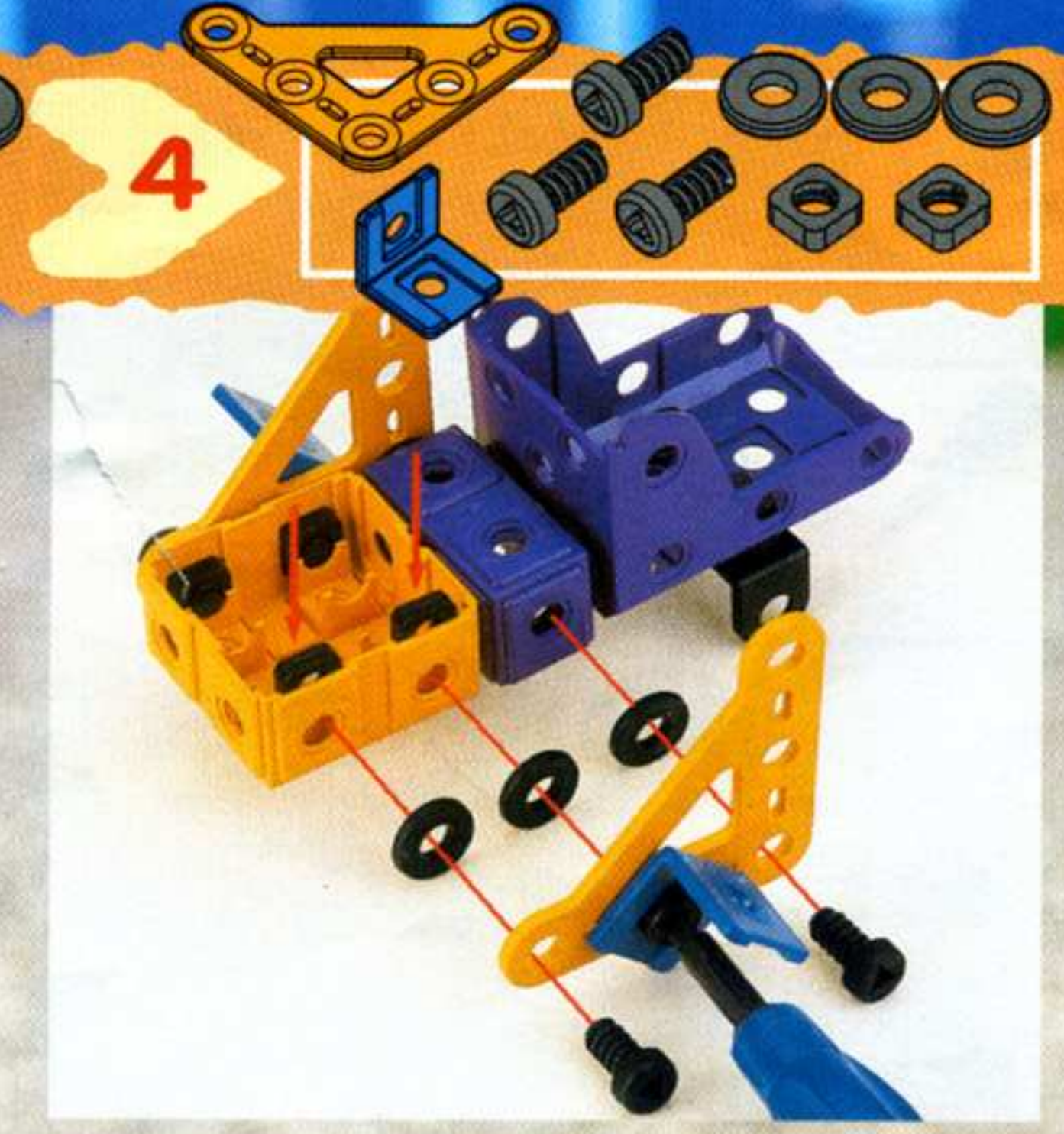
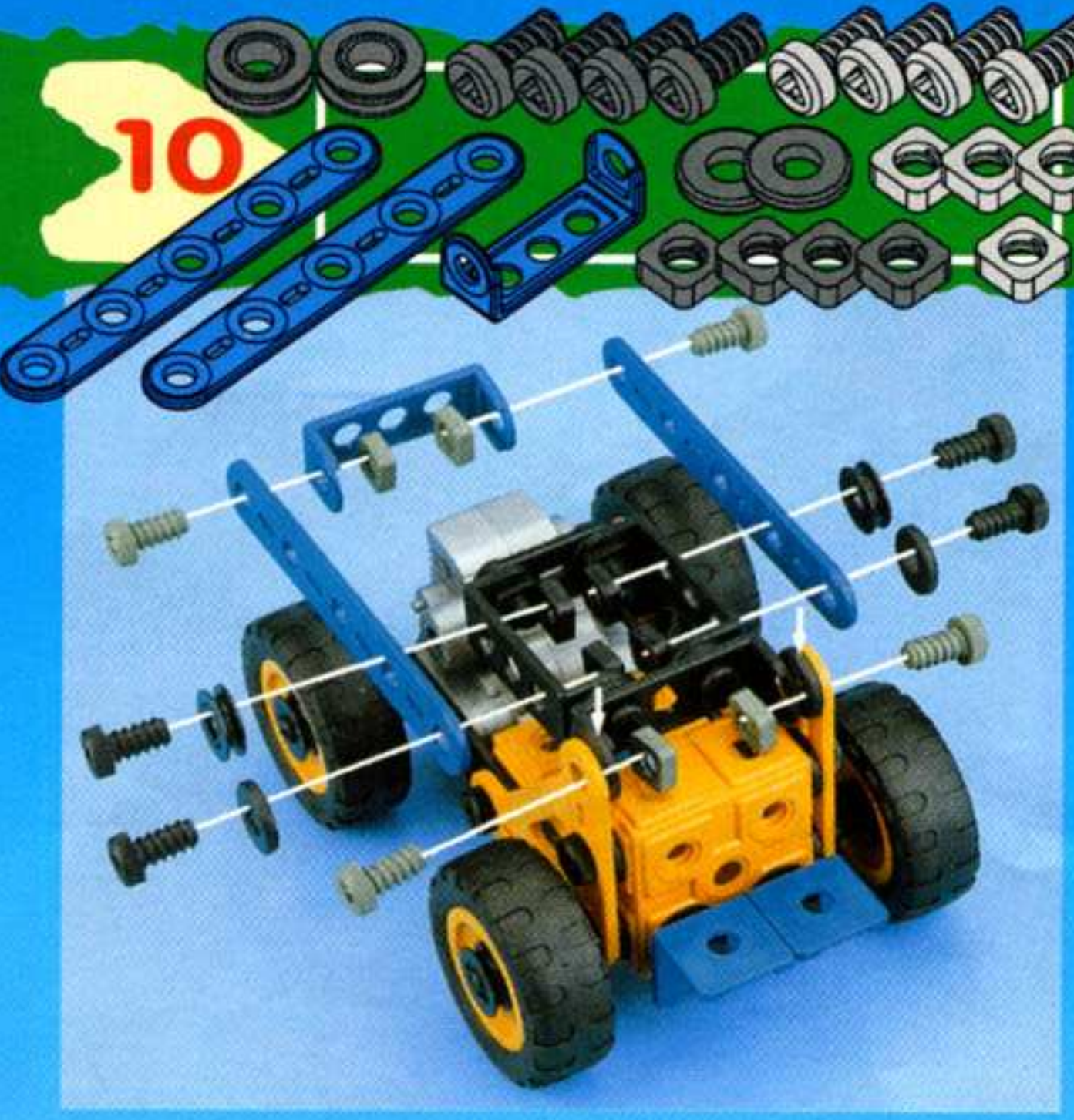
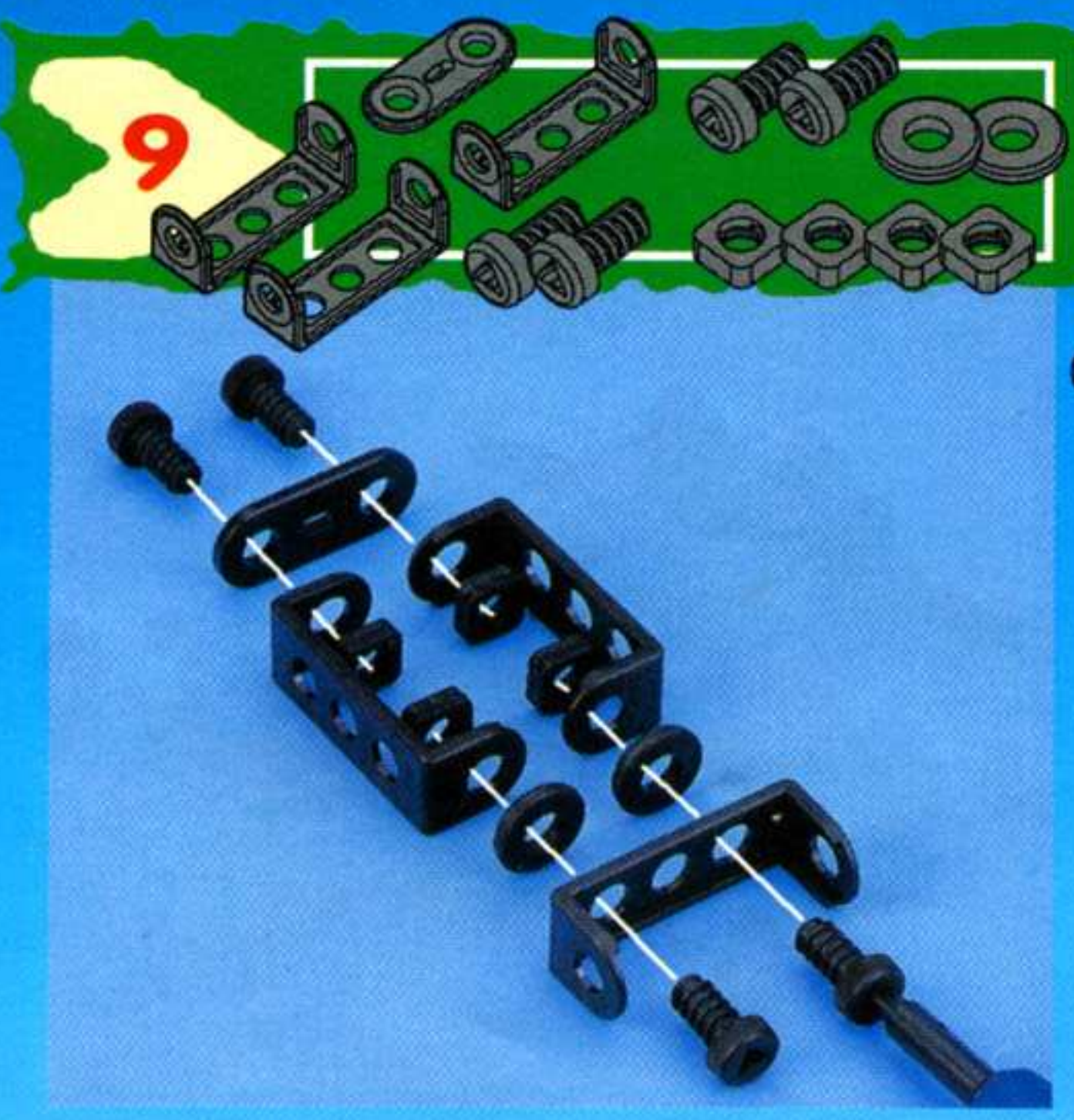

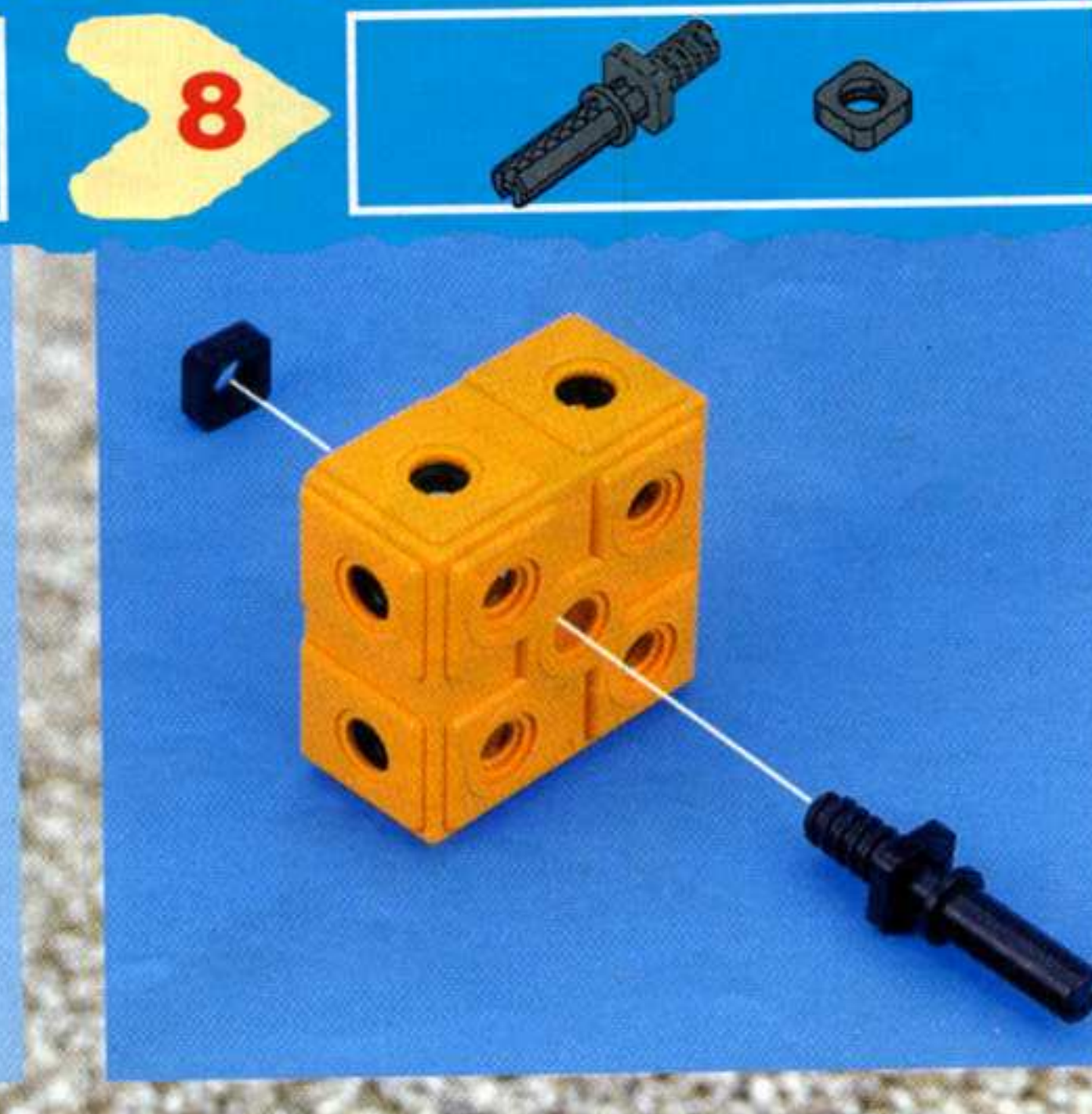
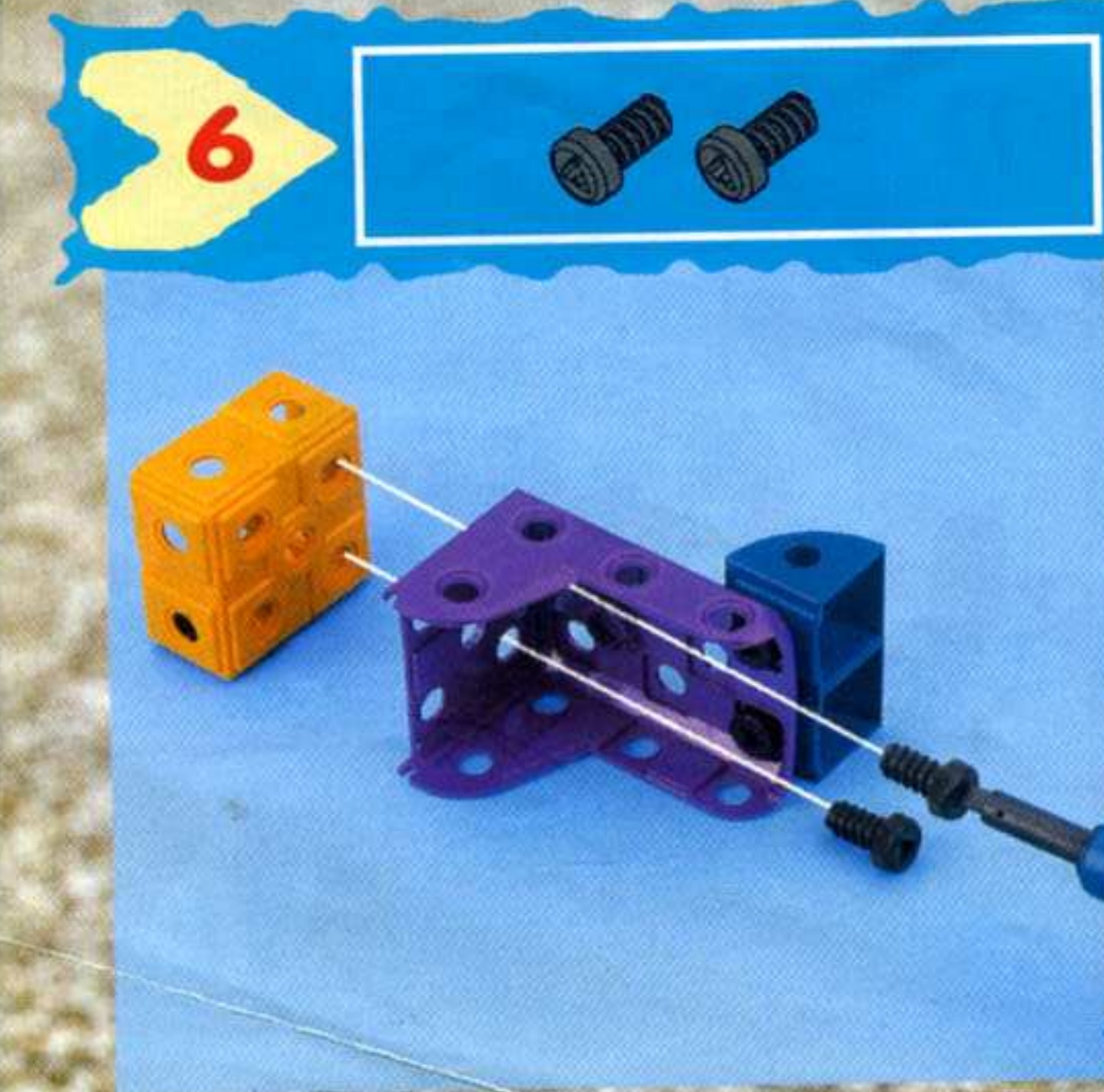
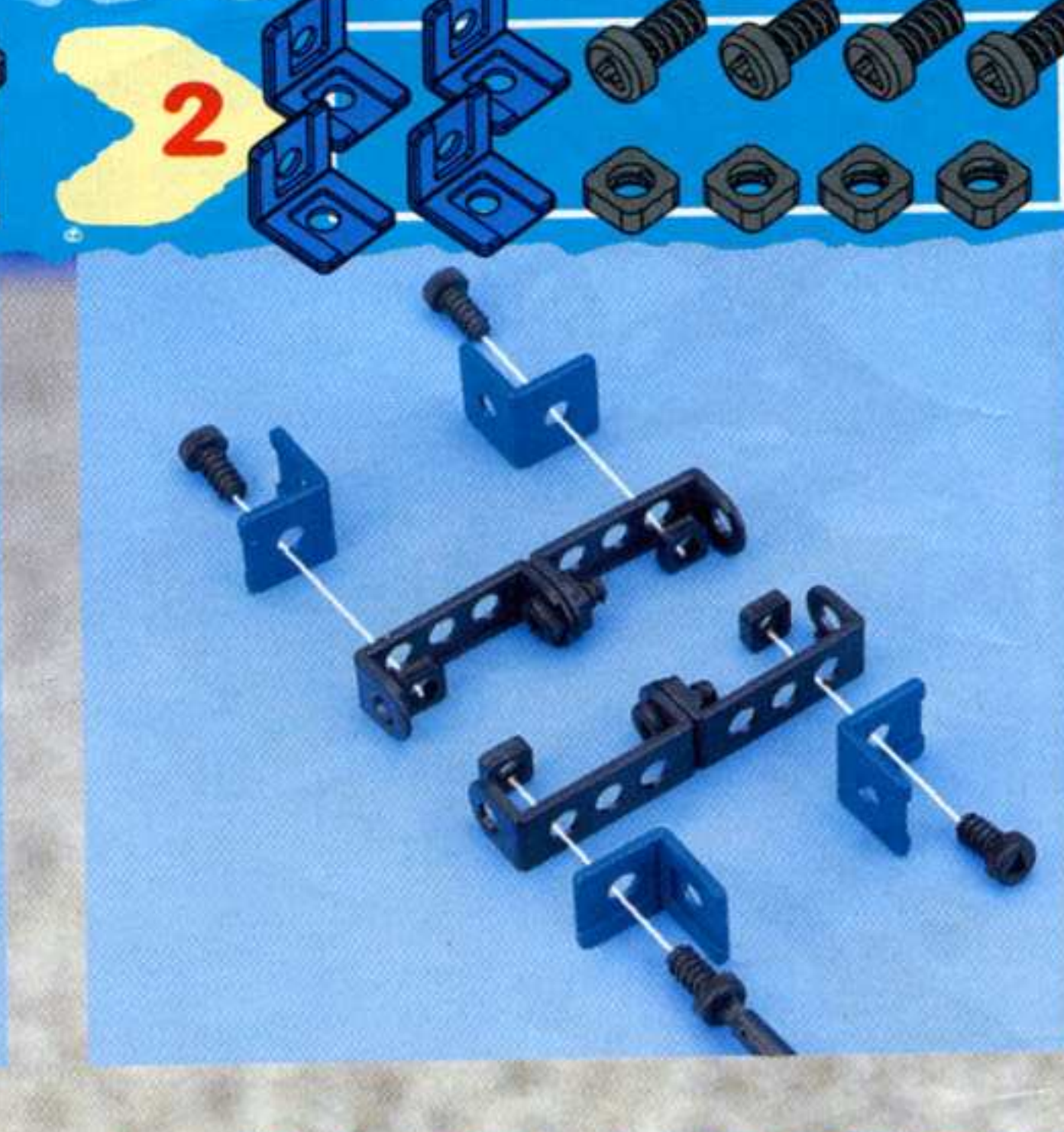

15

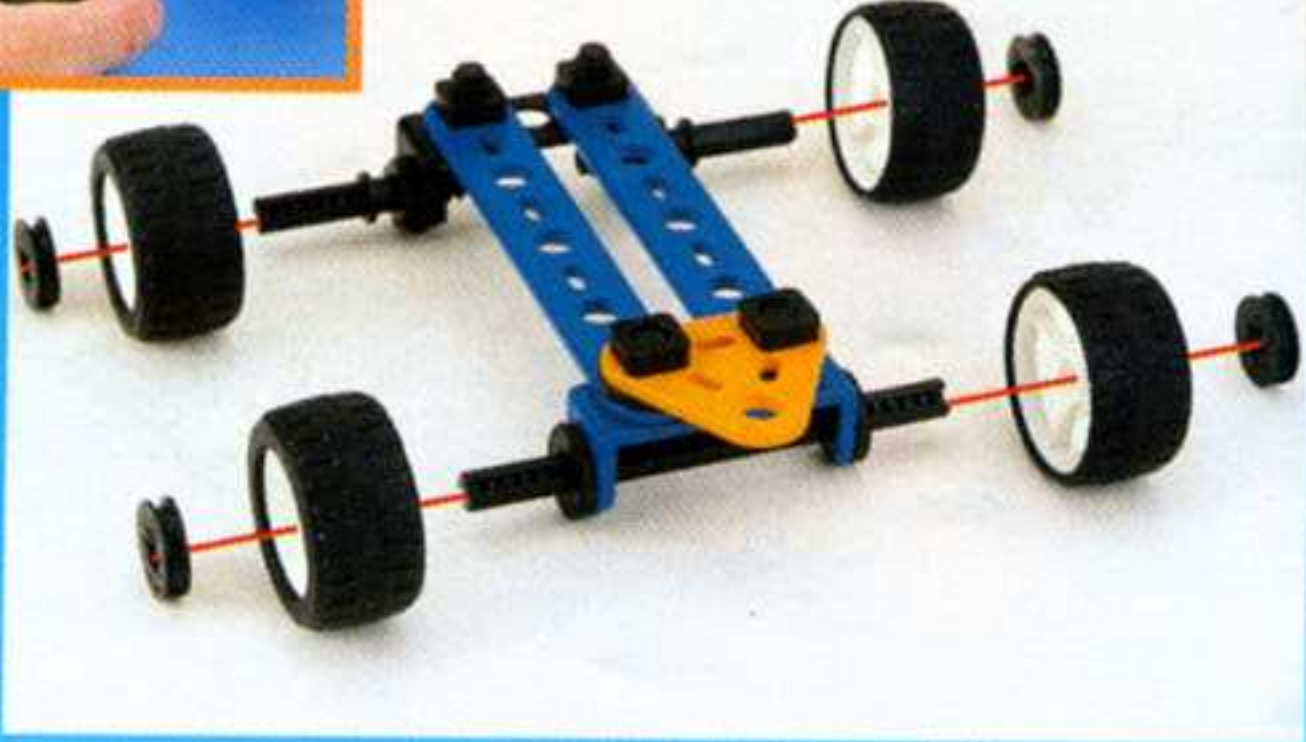
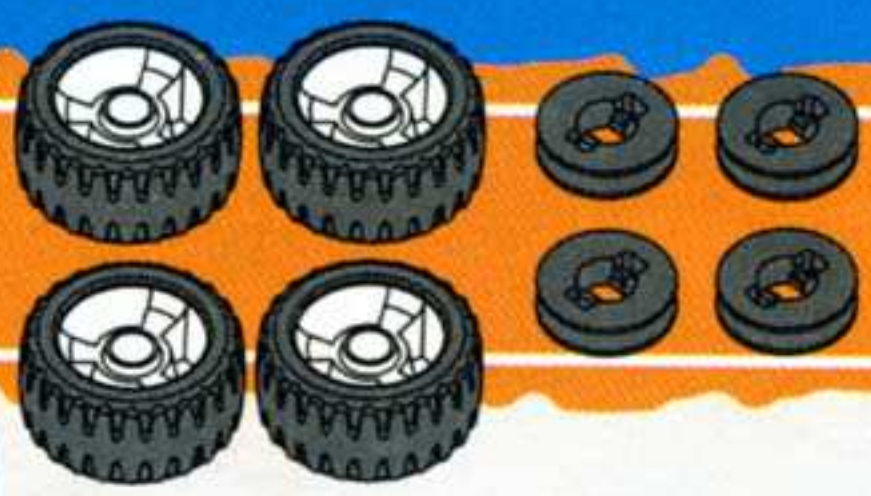

16



17



3

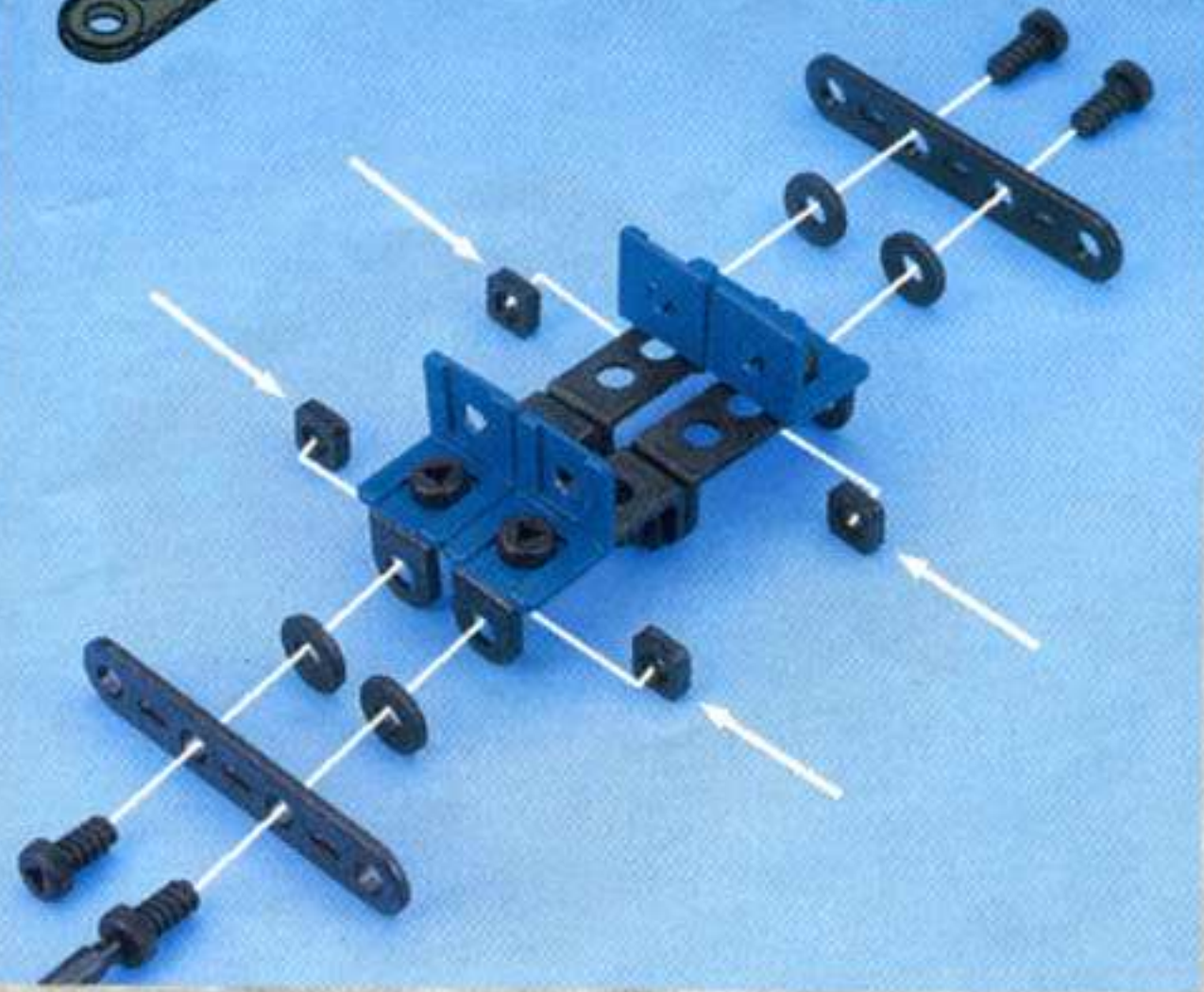

4



5

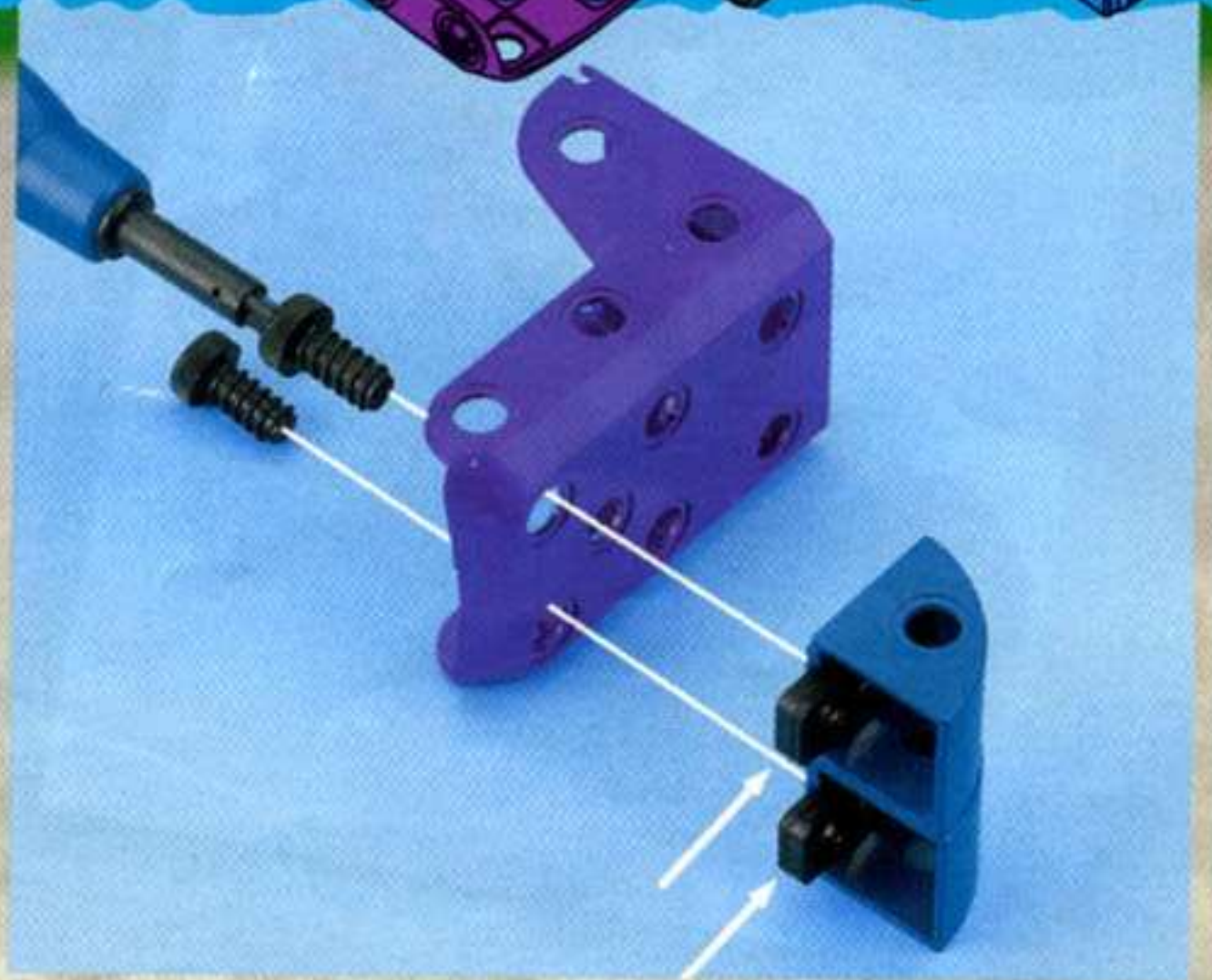

9

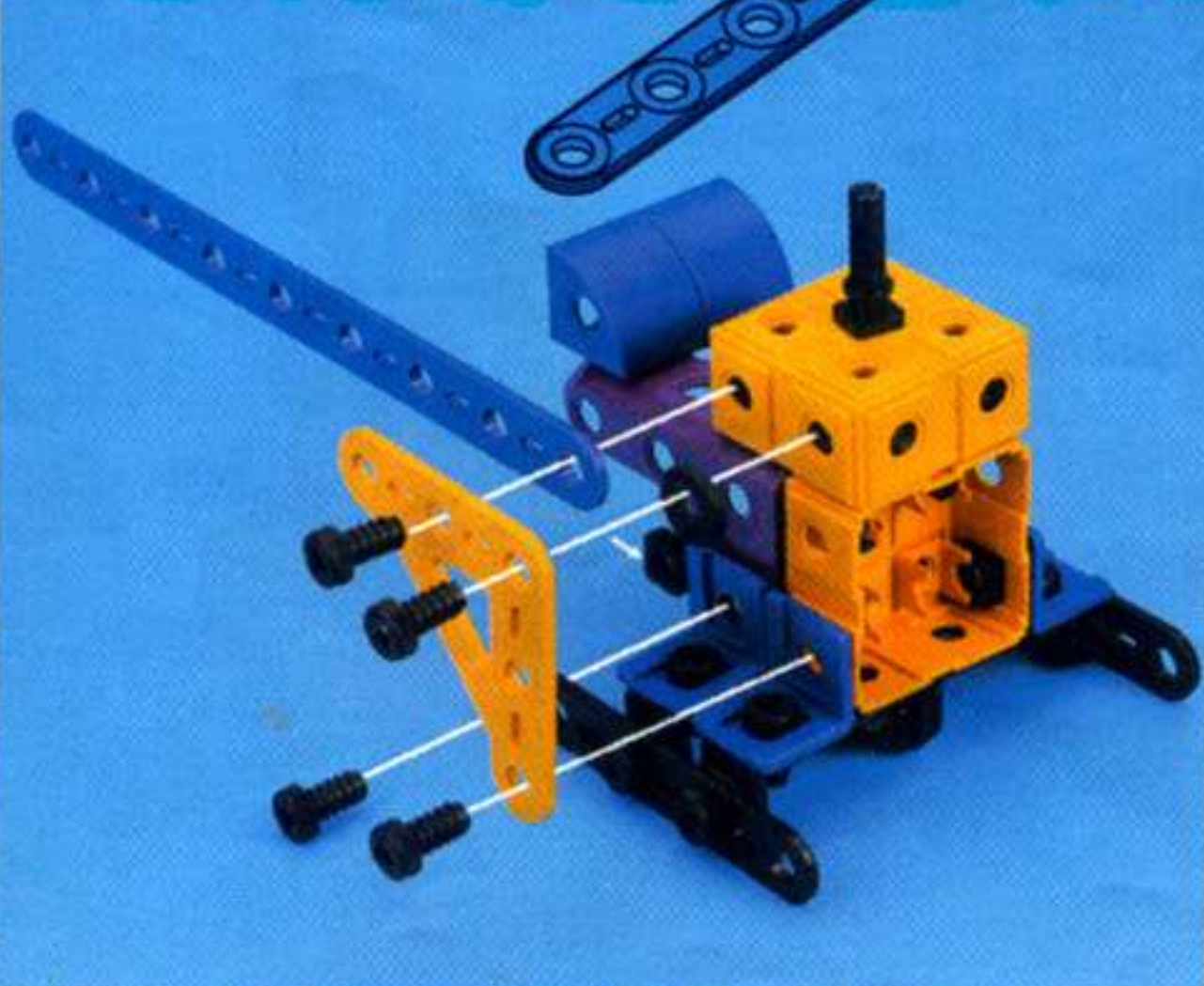

10

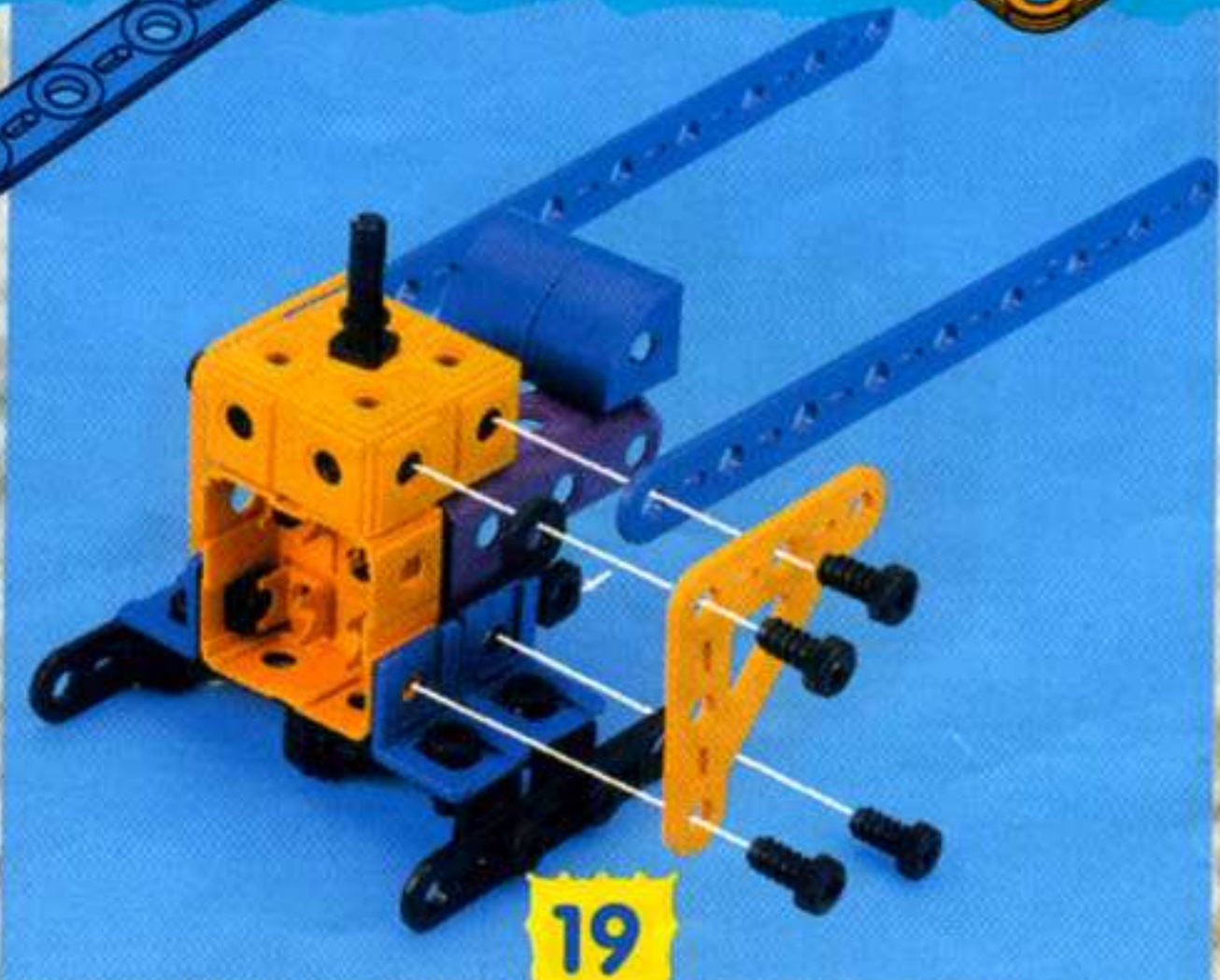

11

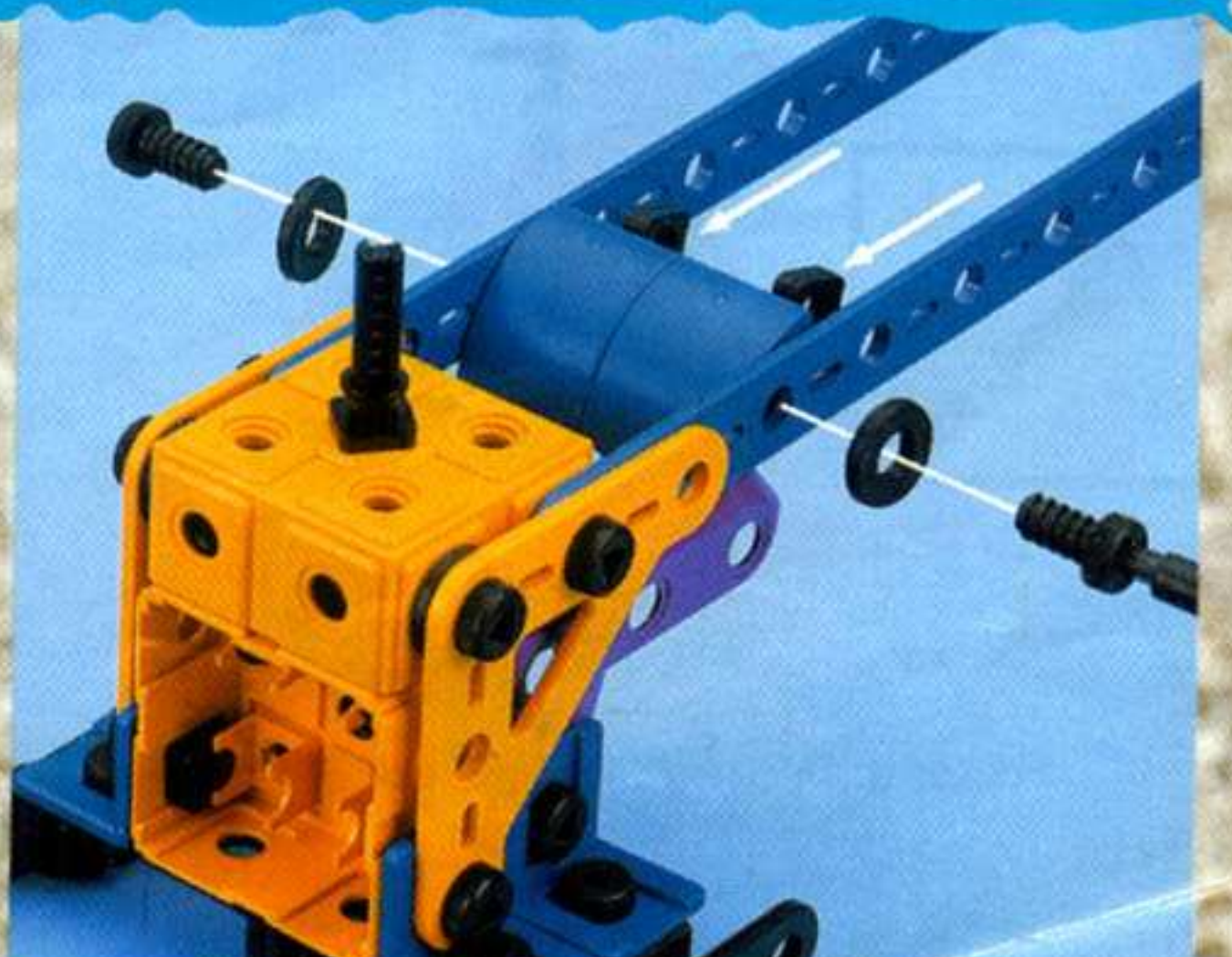

19

12

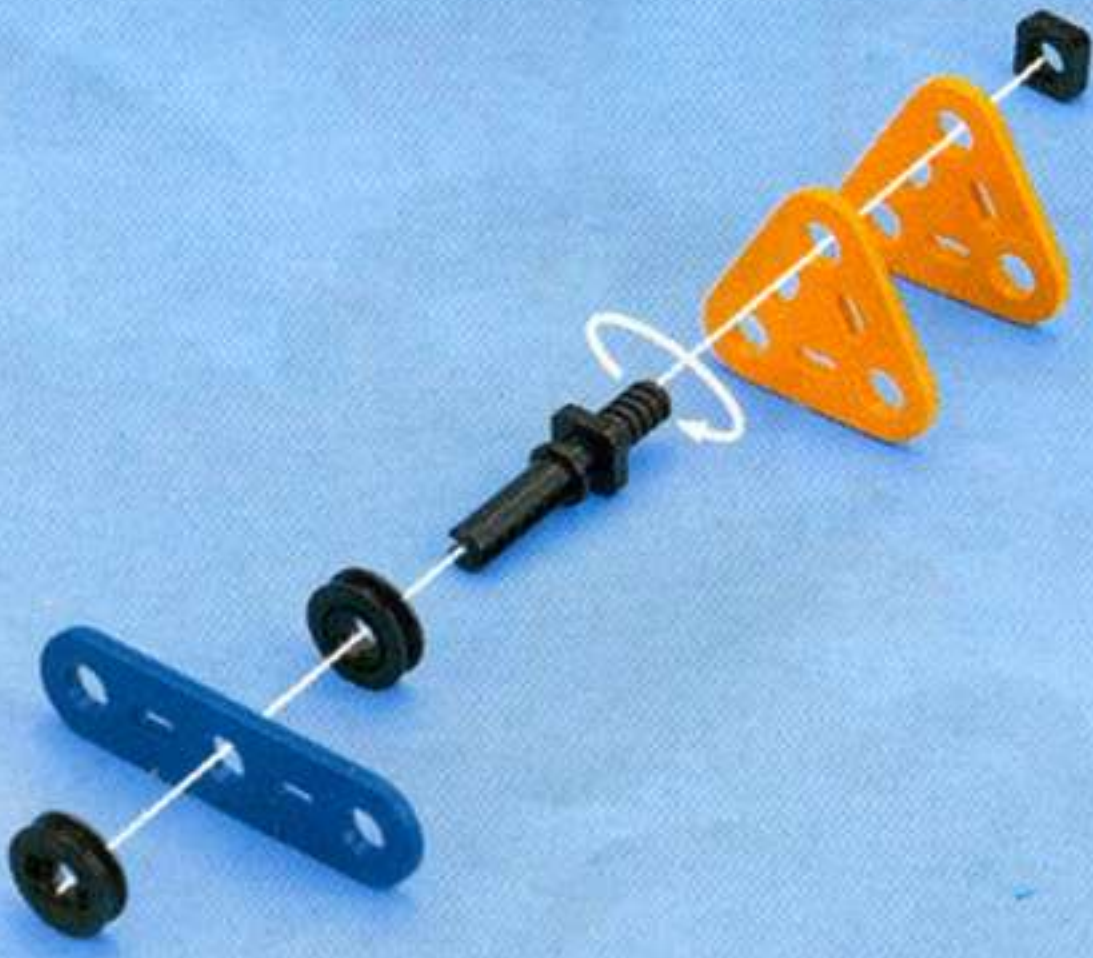

13

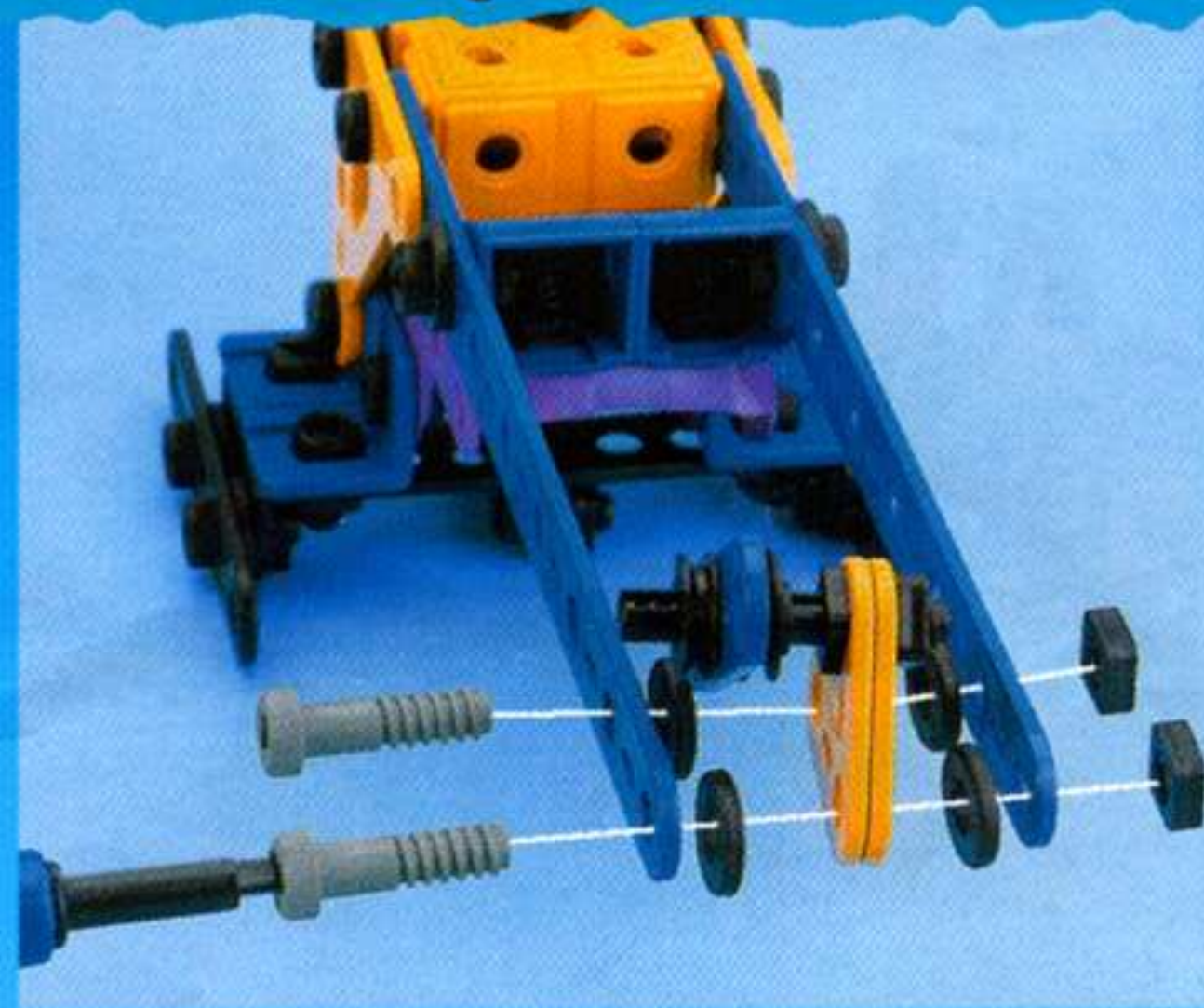

14

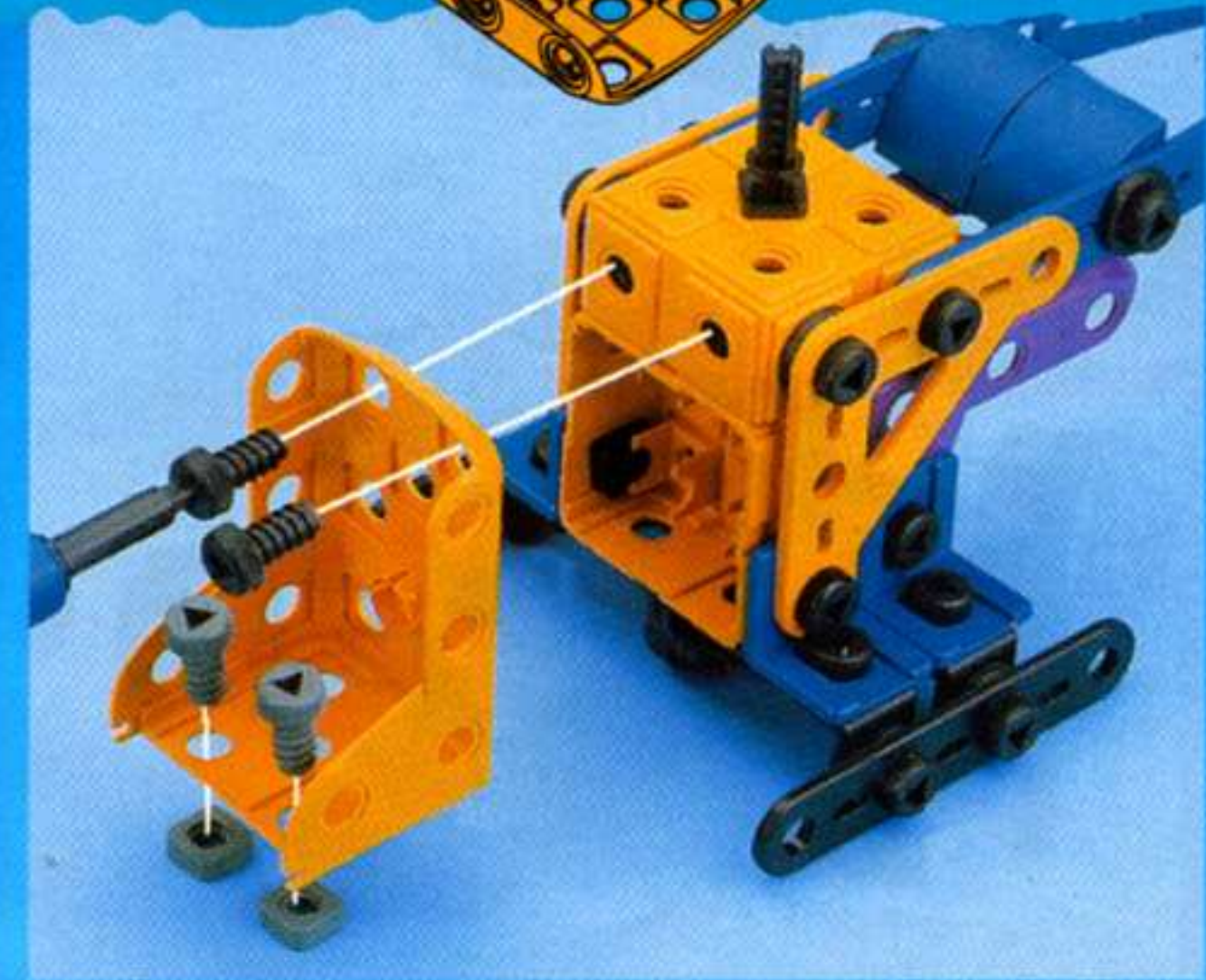

18



19



20



1

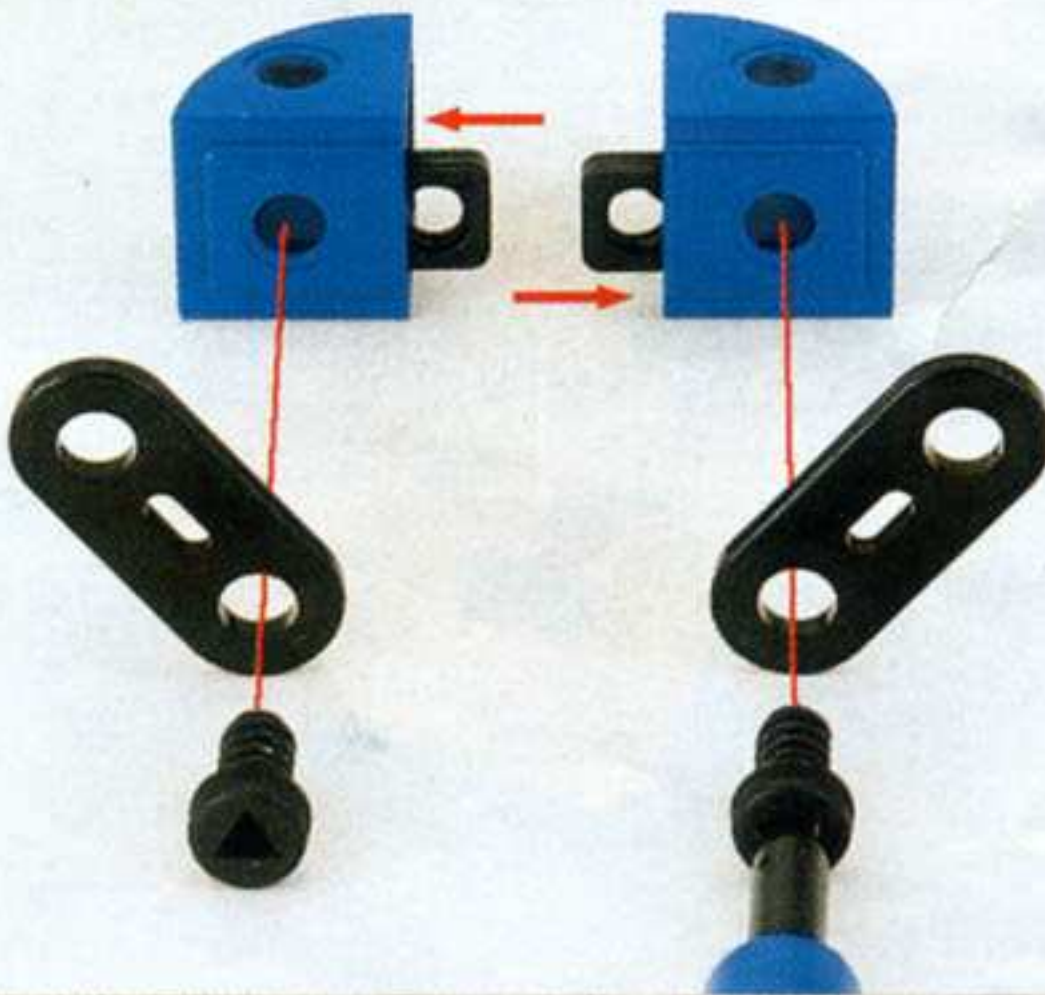

2

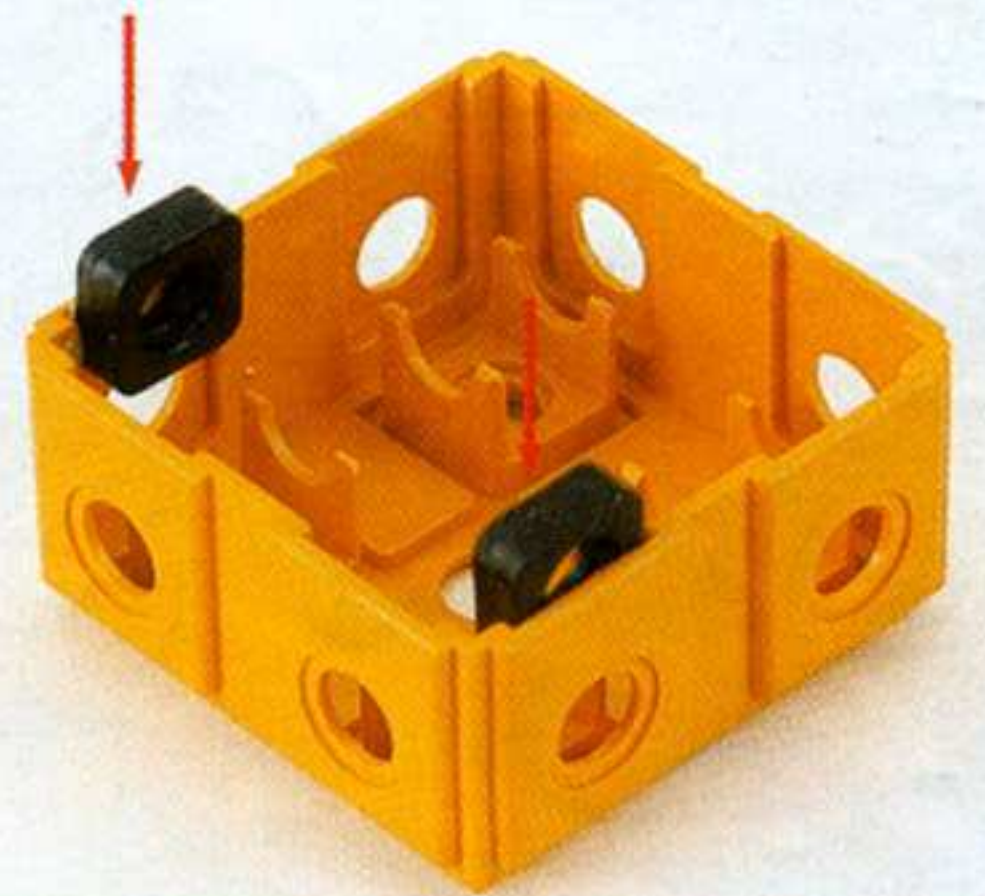

6

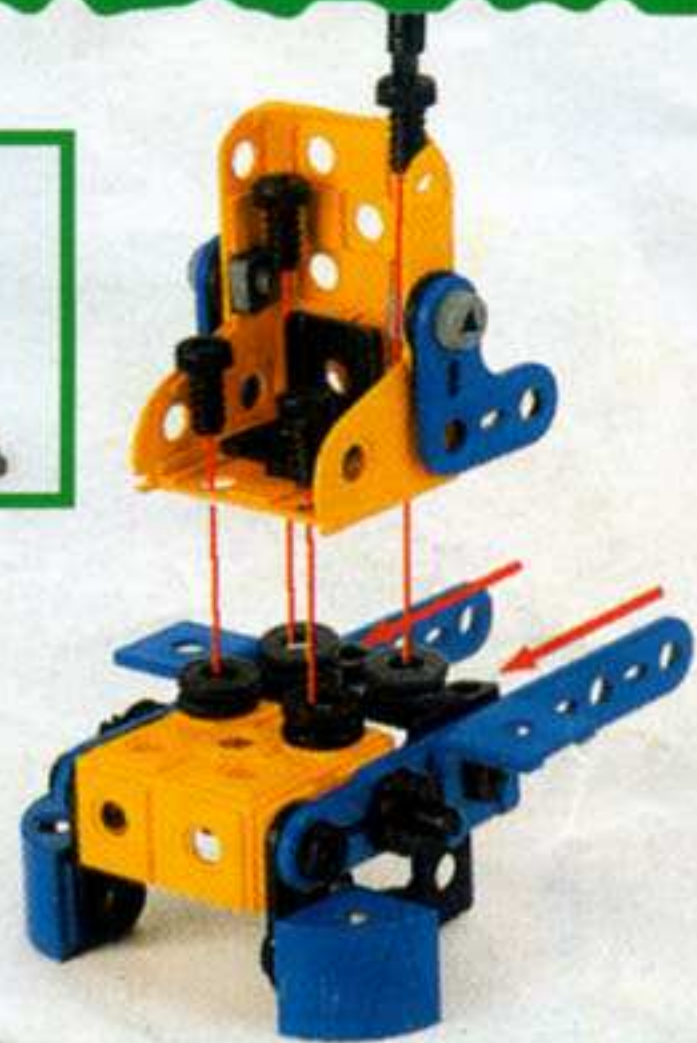

7

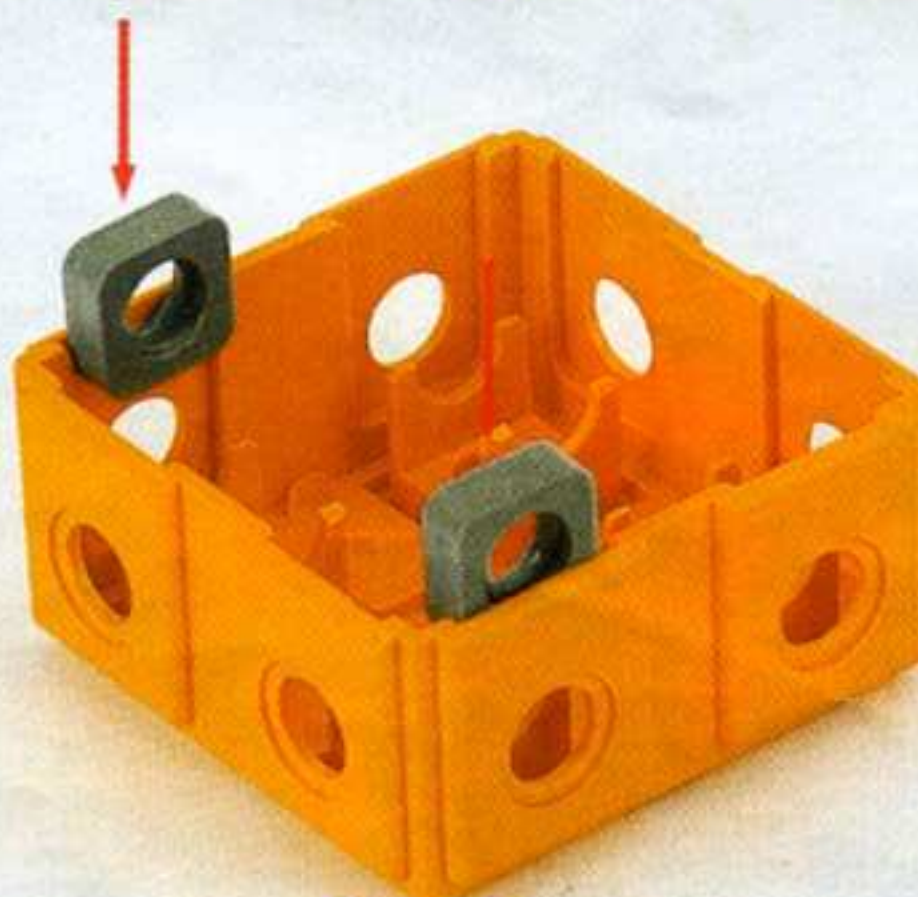

8

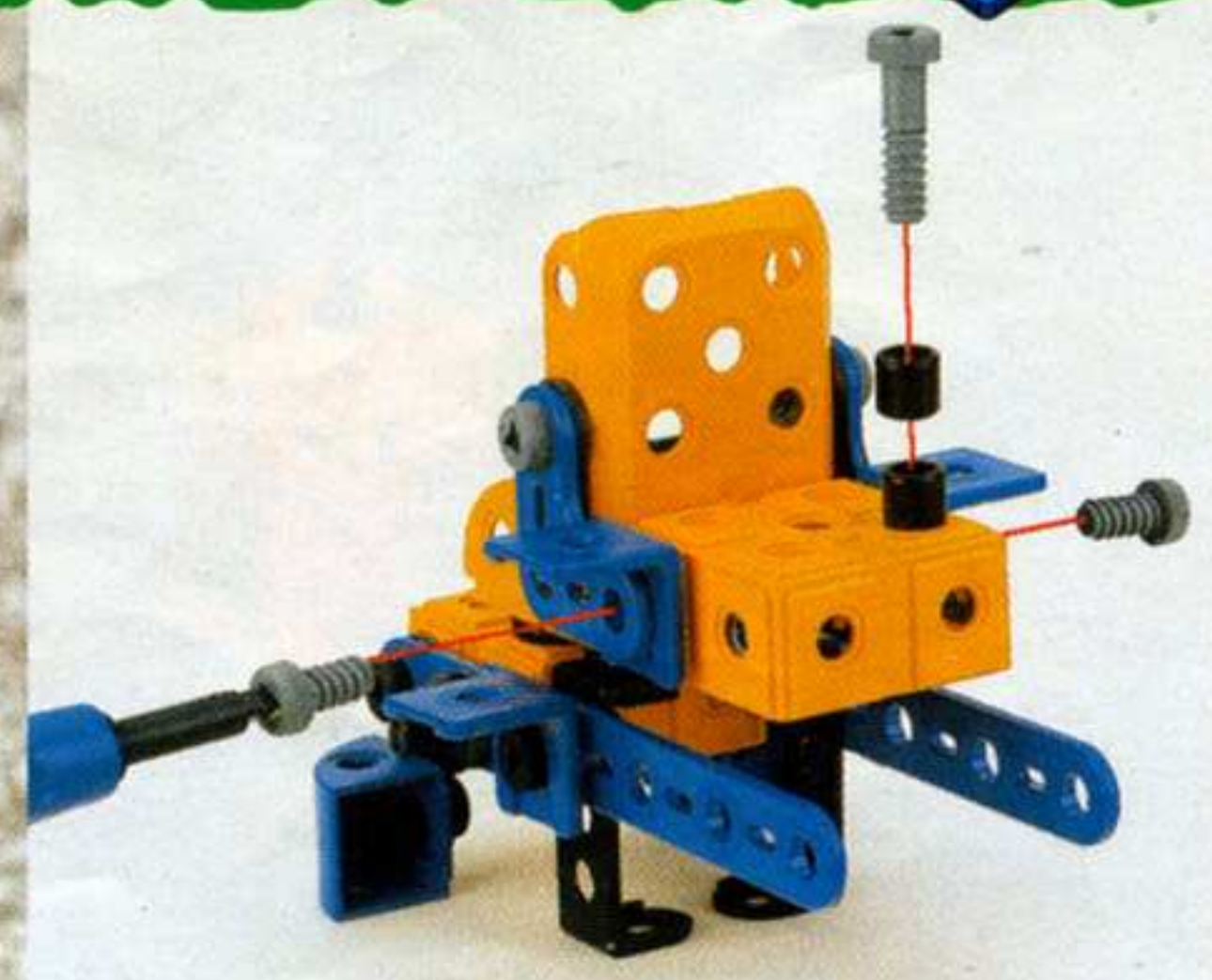

15

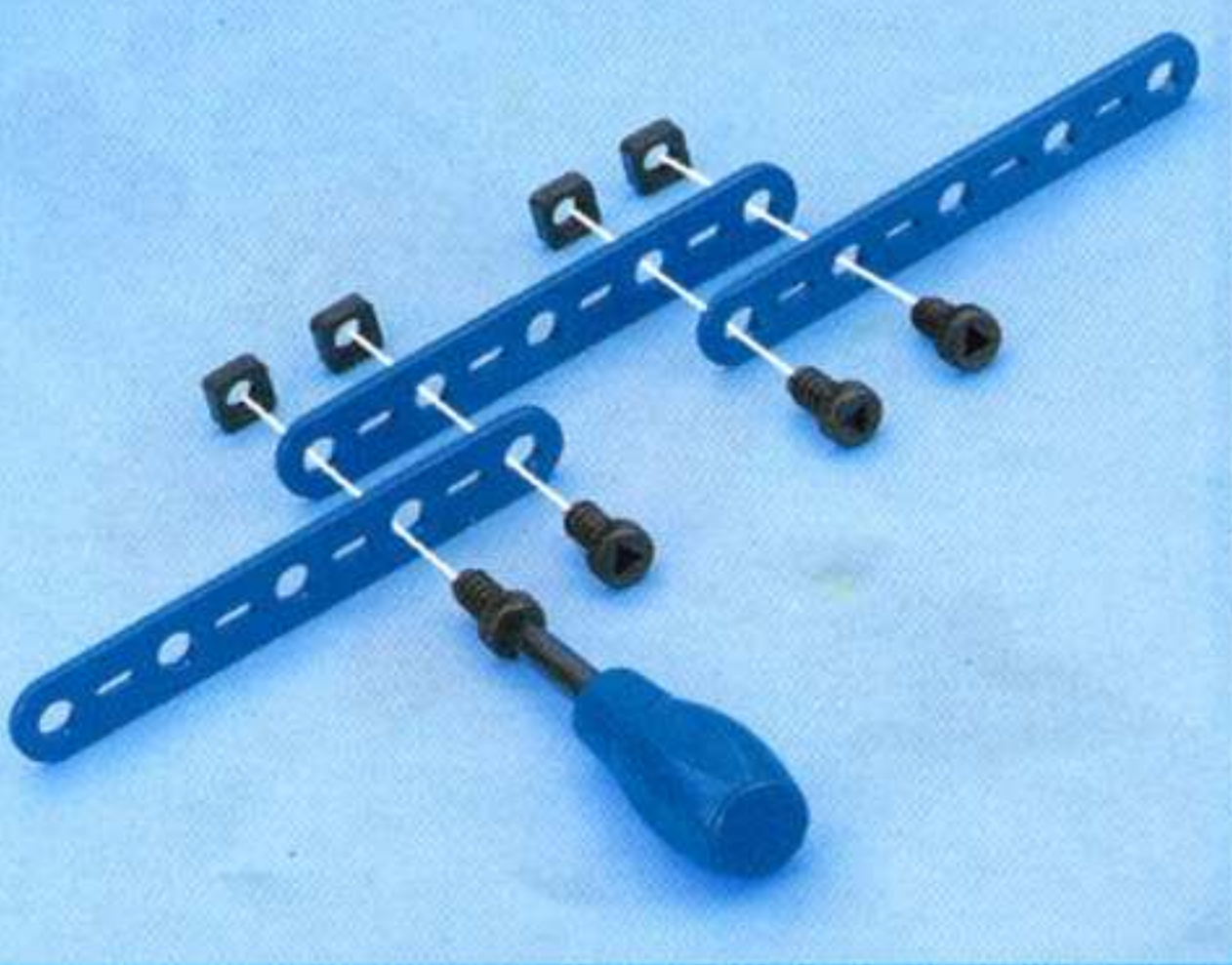
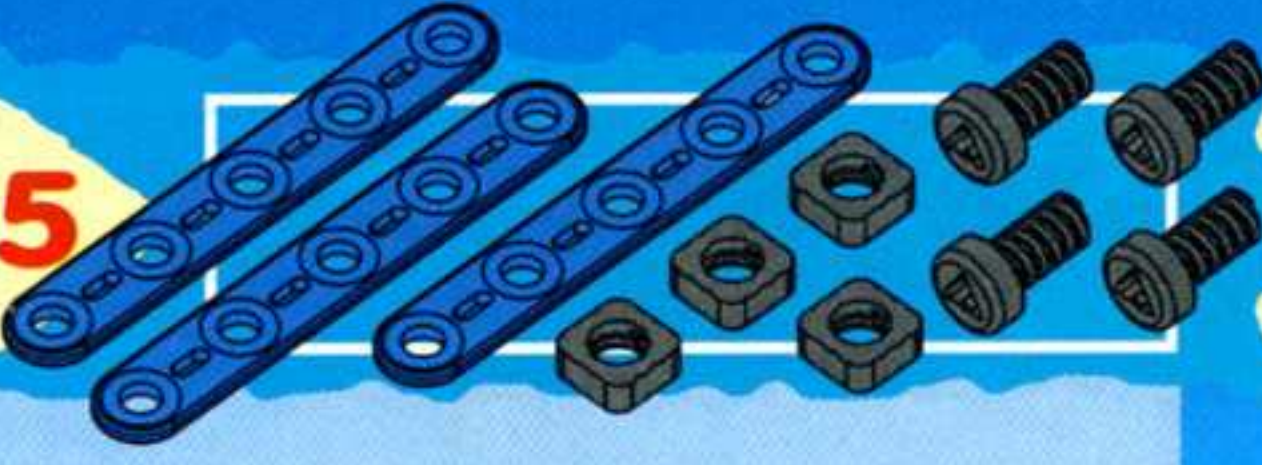

16

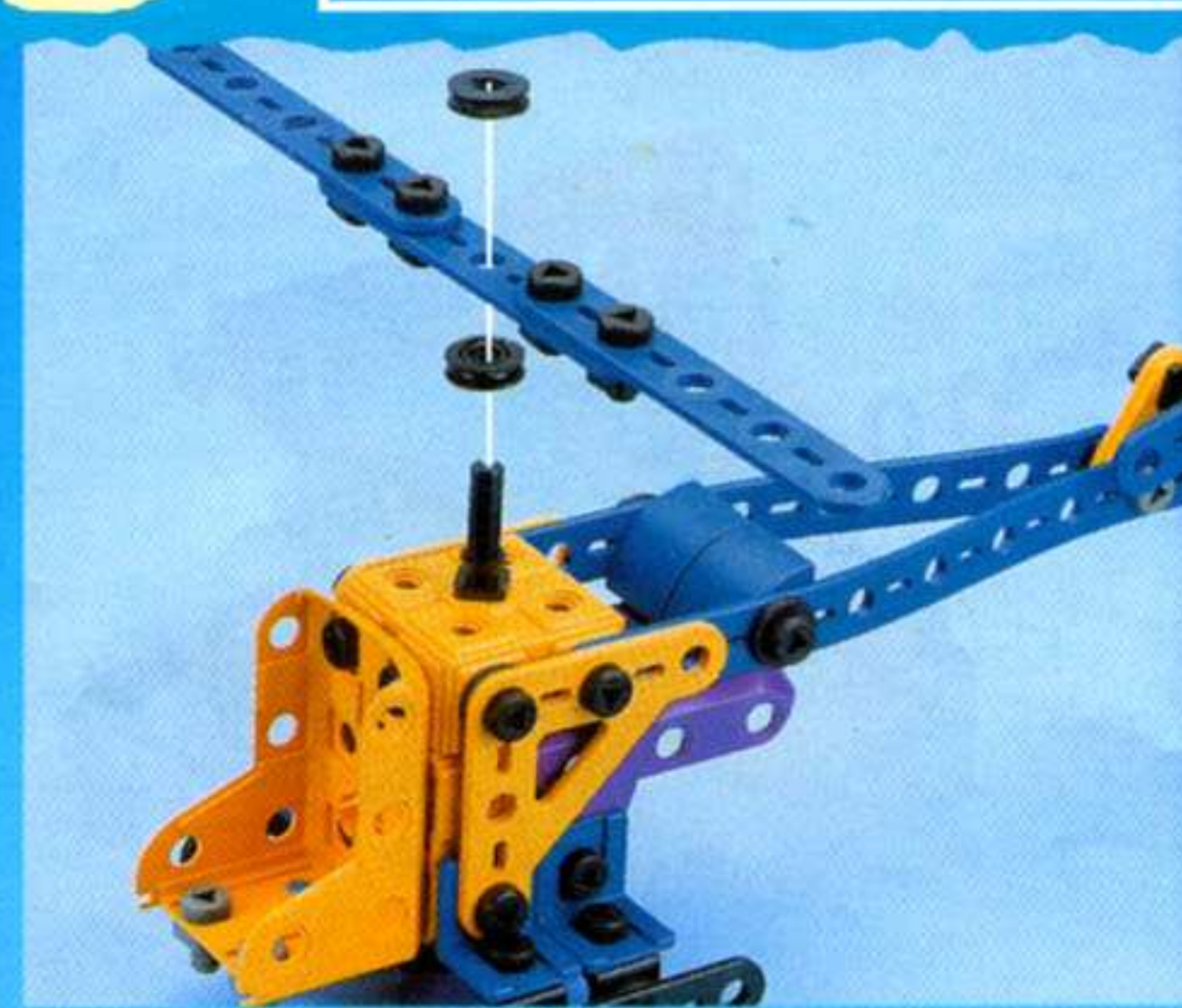

17



21

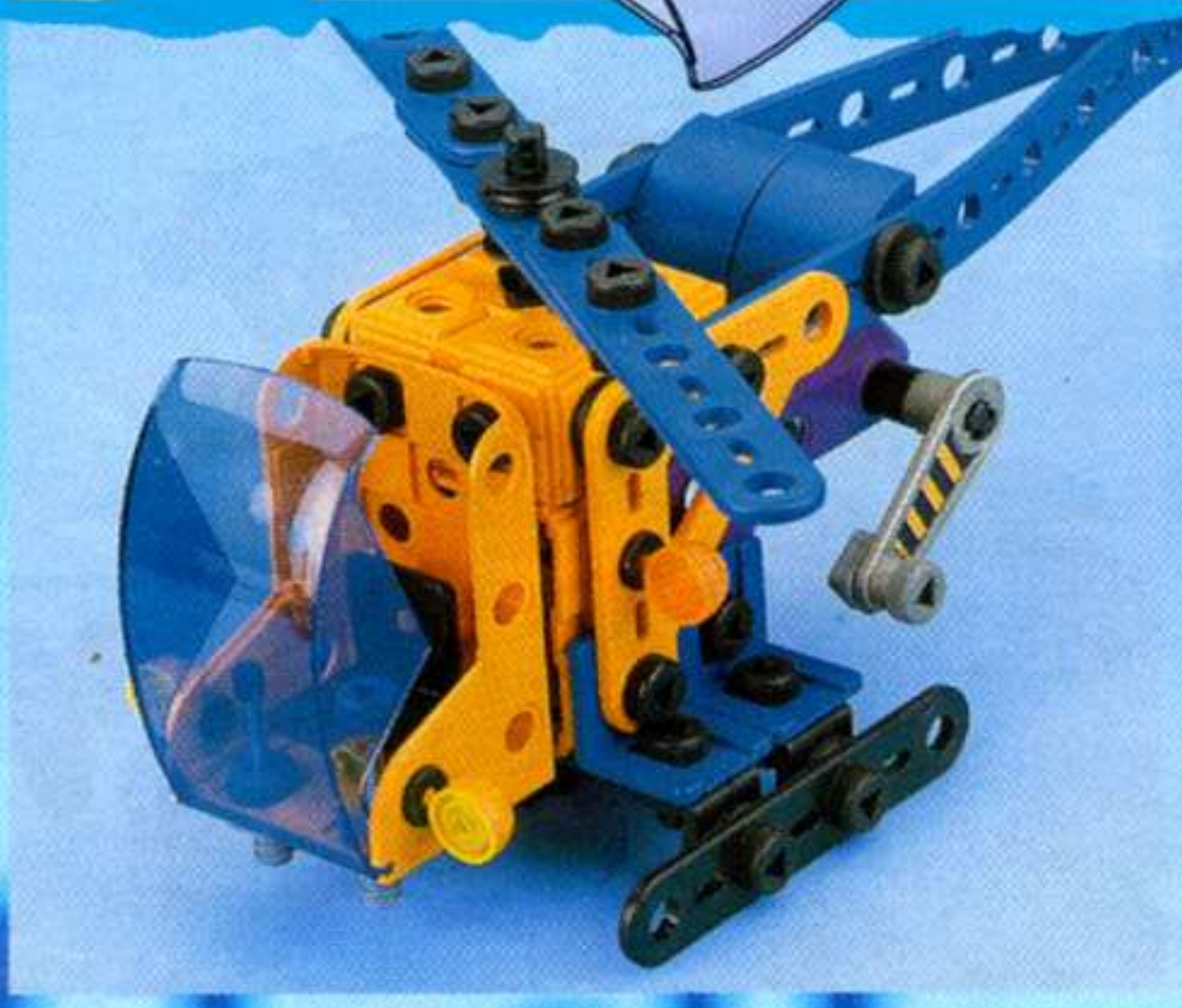

3

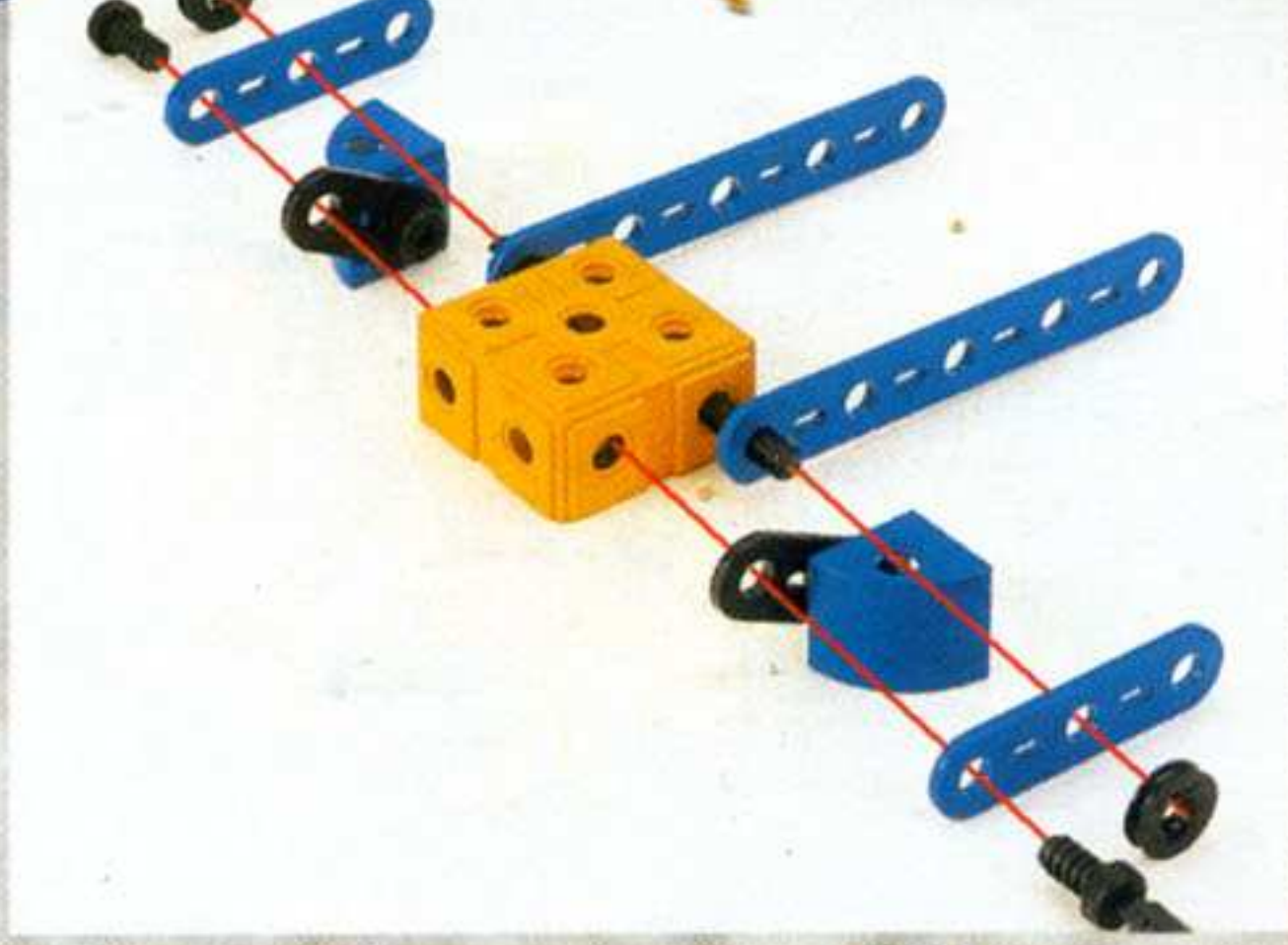

4

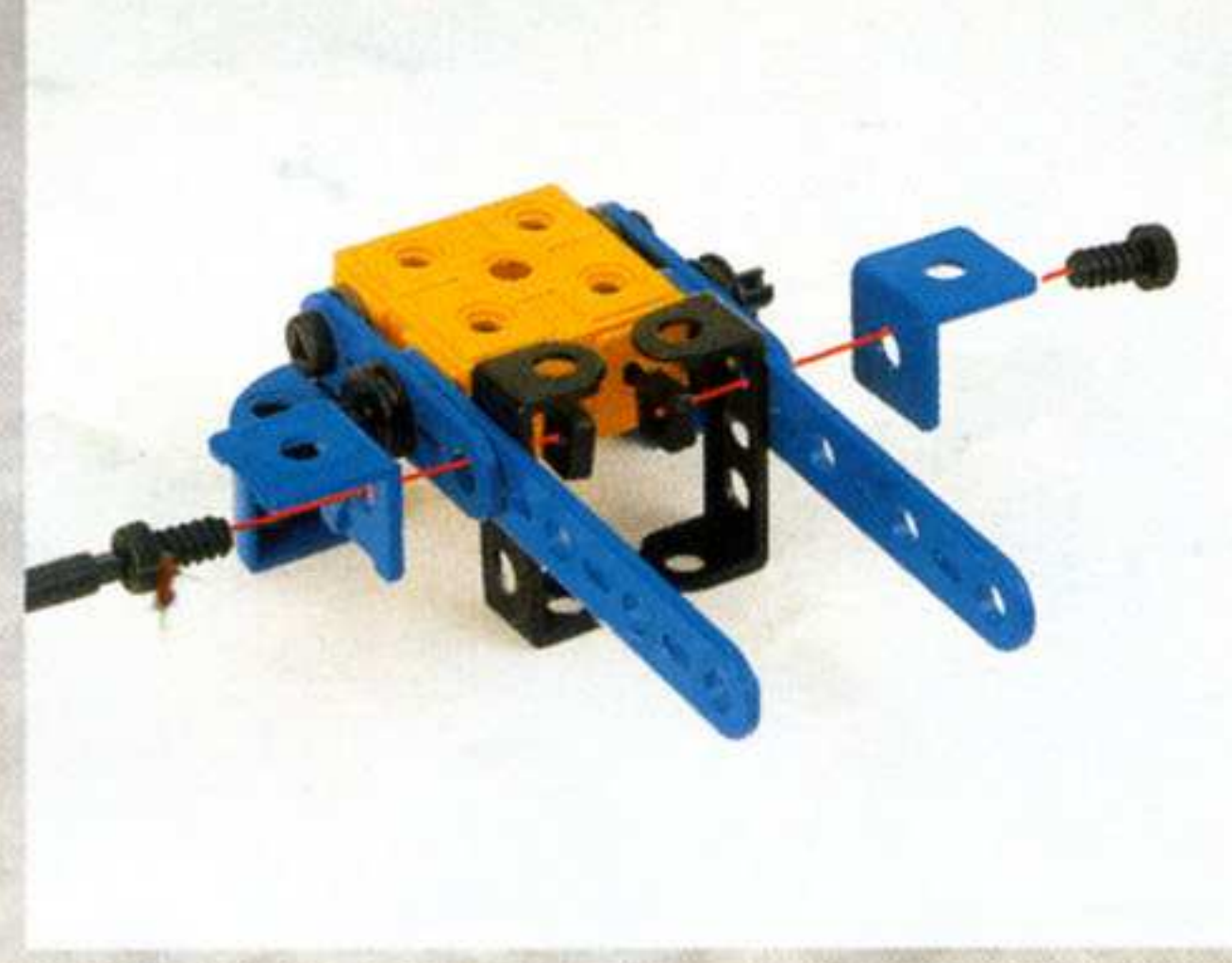
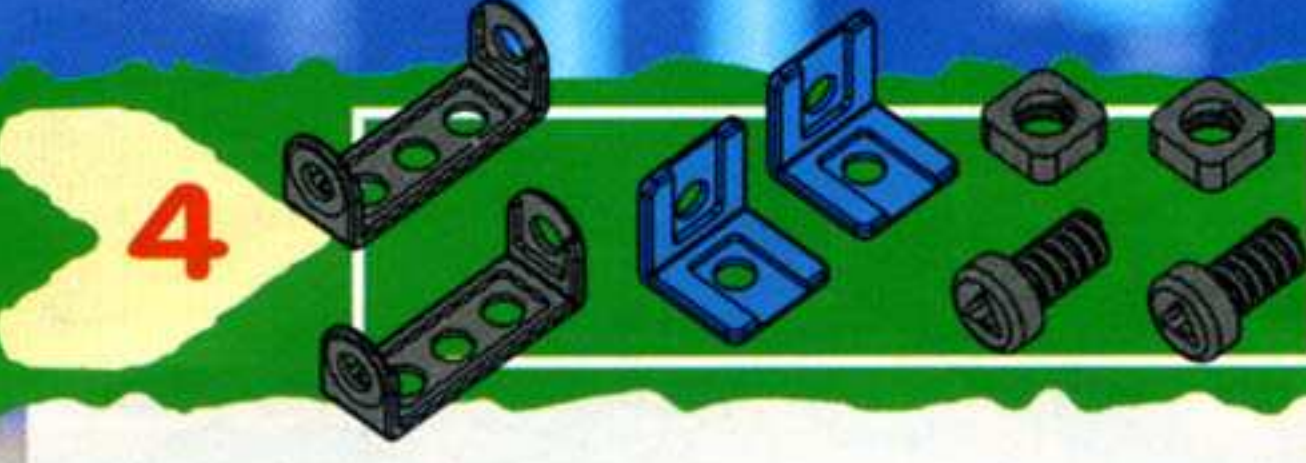

5



9

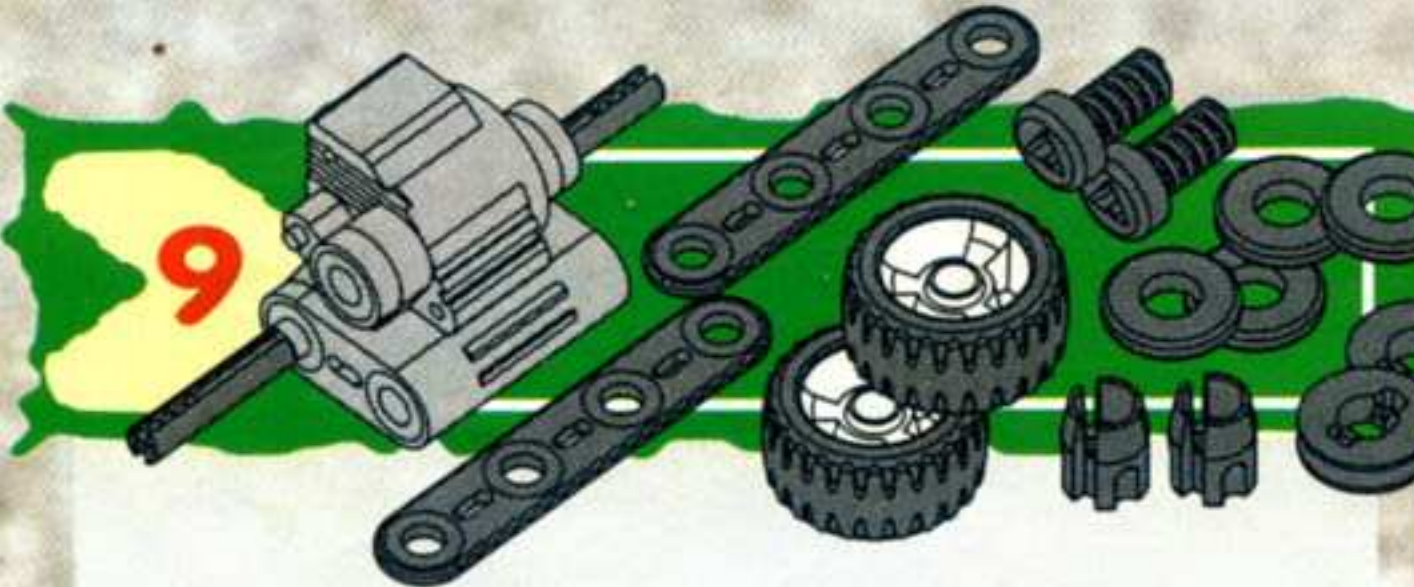

10

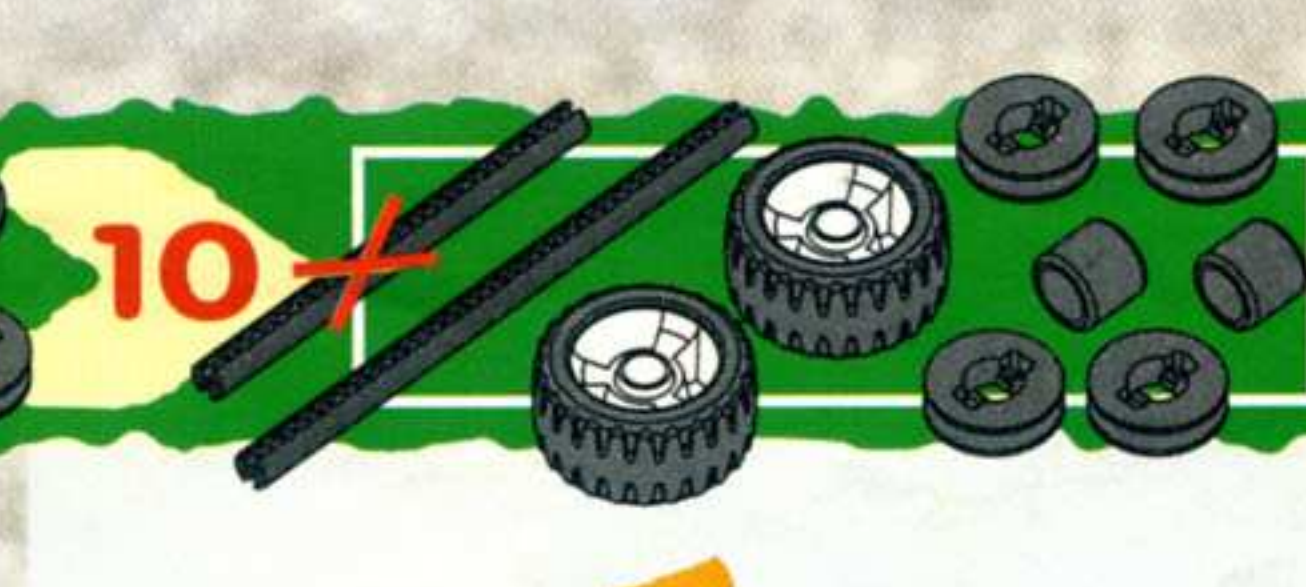

11

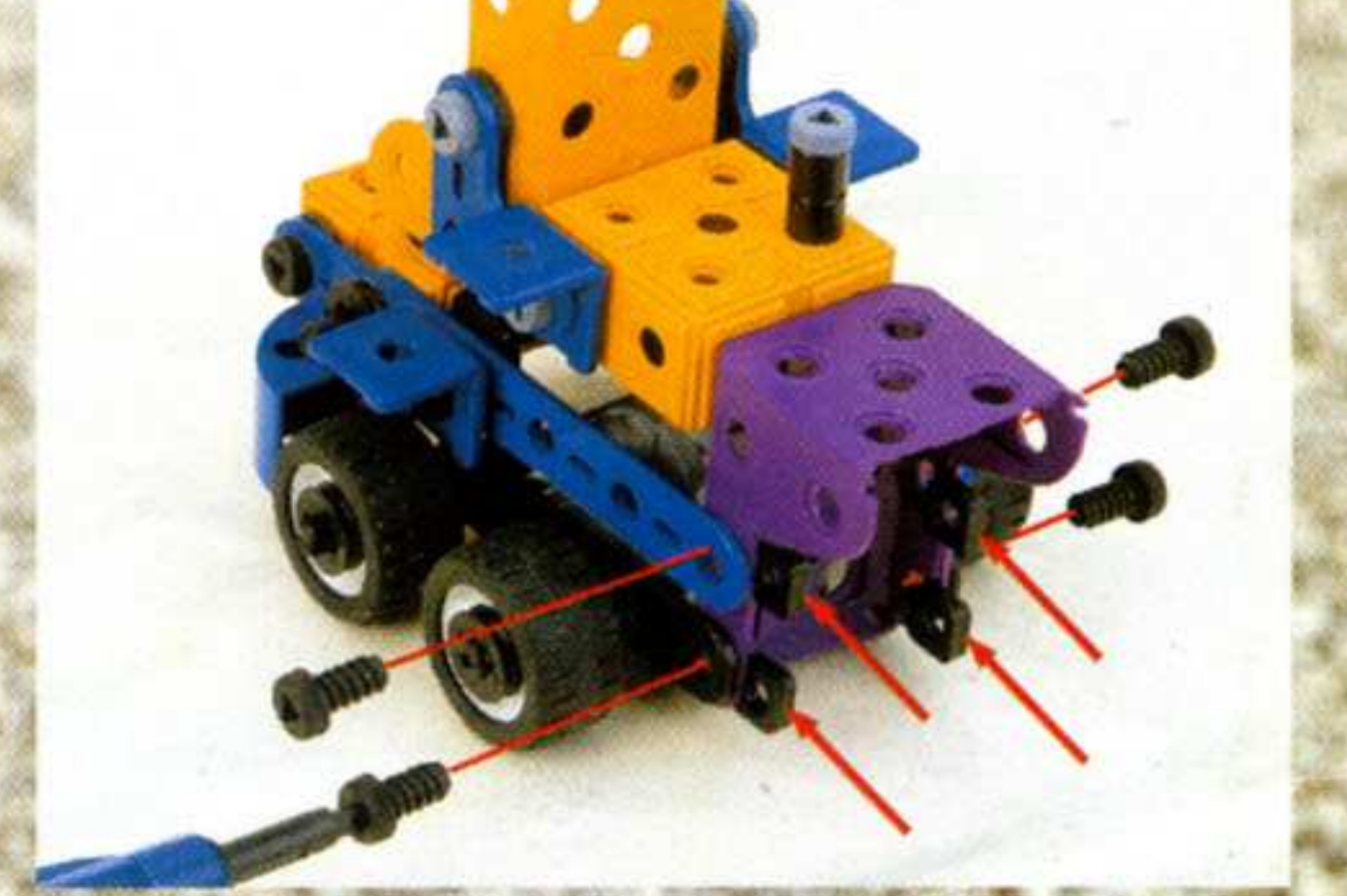

21

12

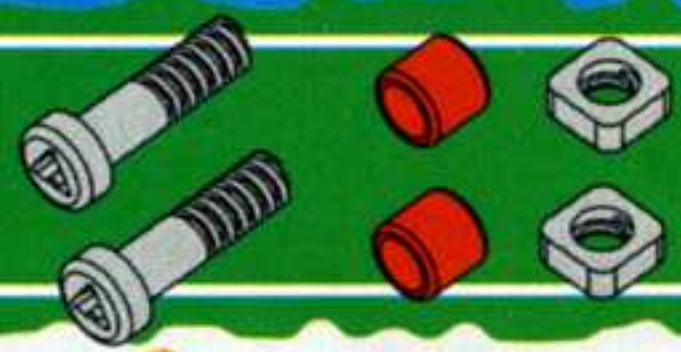

13



14



18

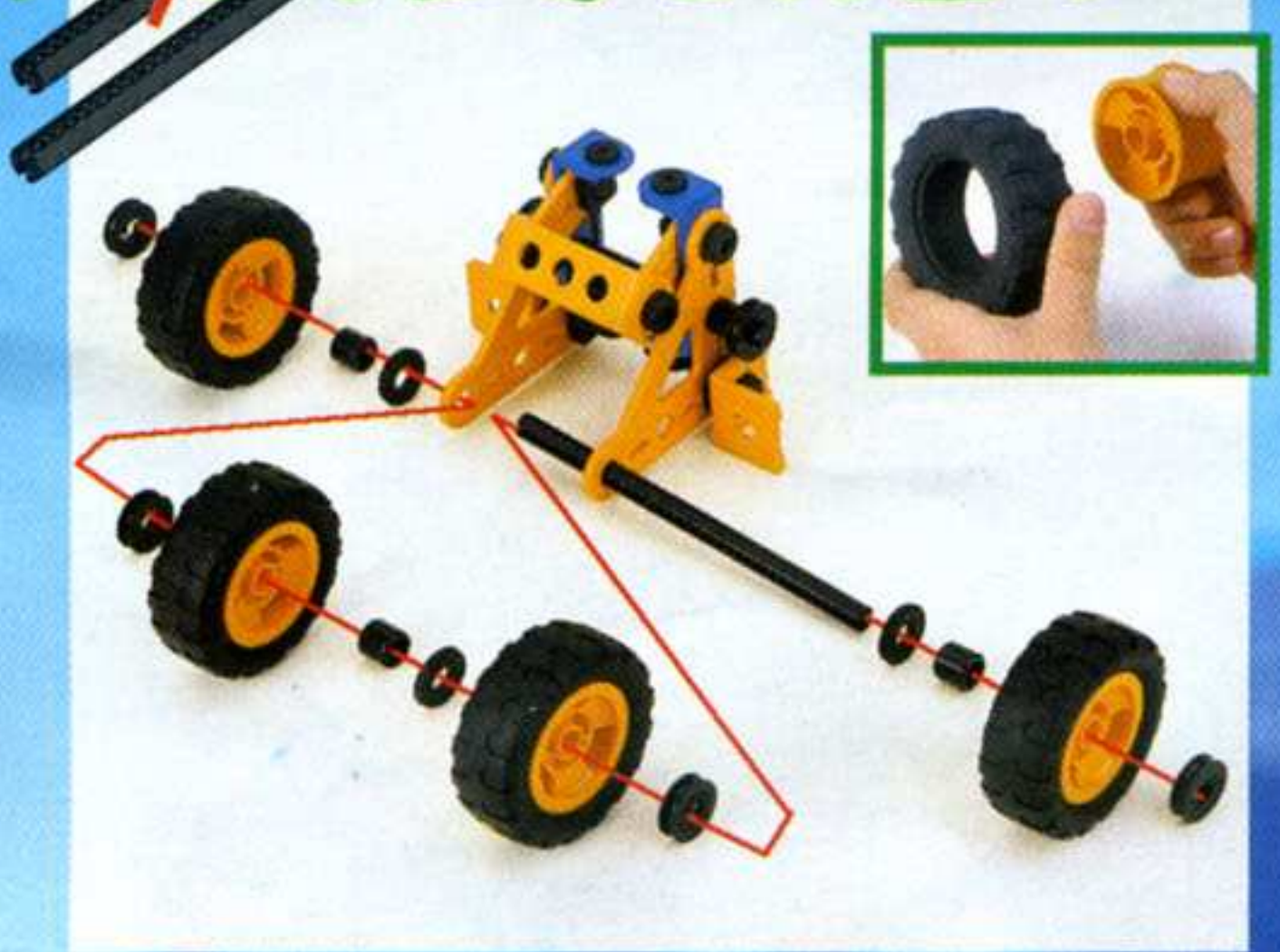

19



20



1

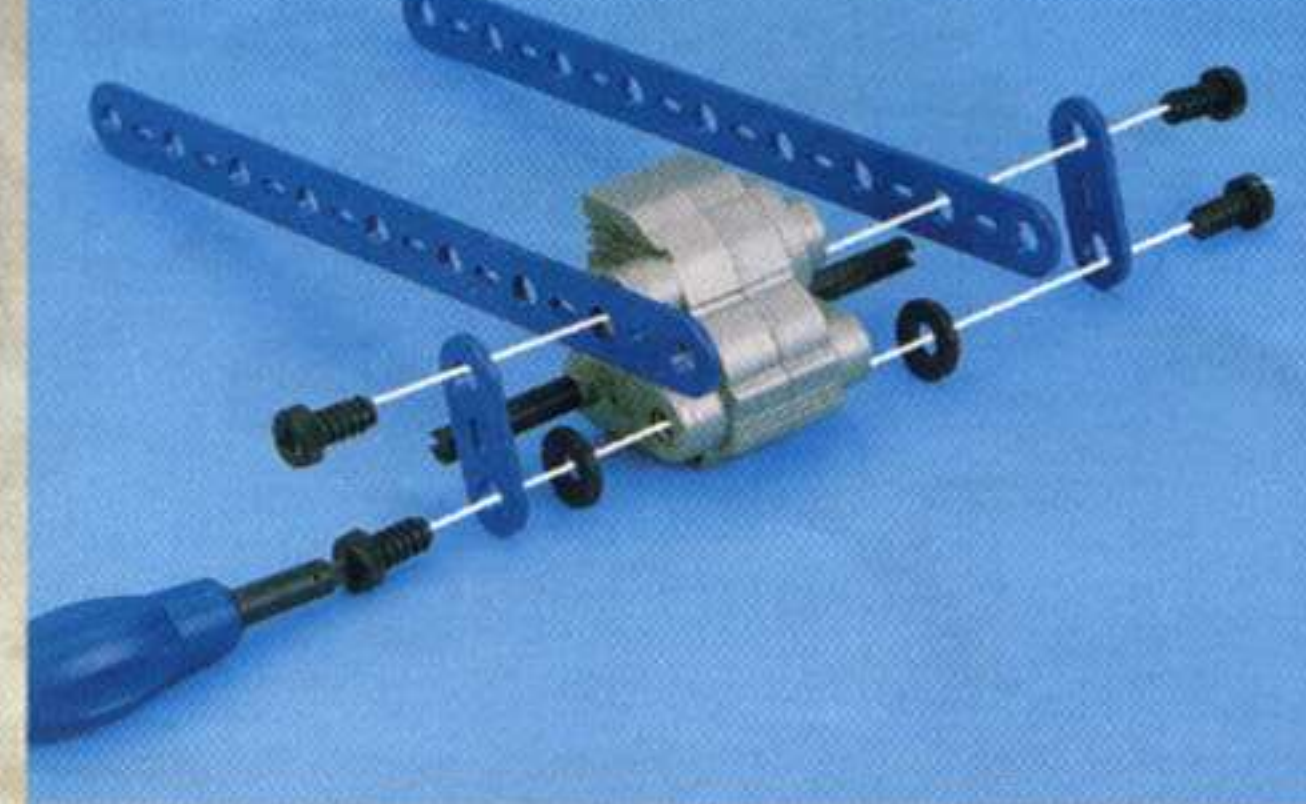
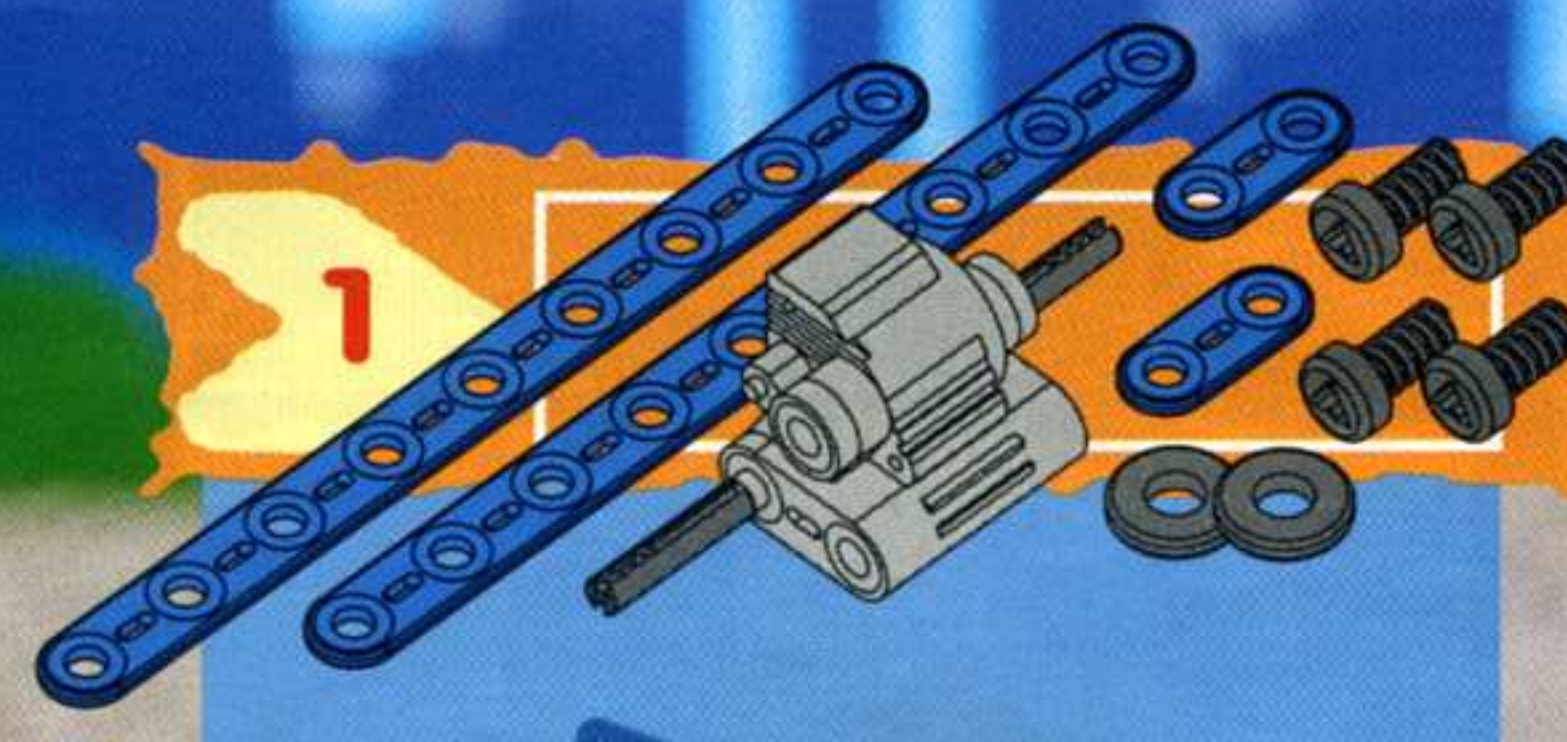

2



6

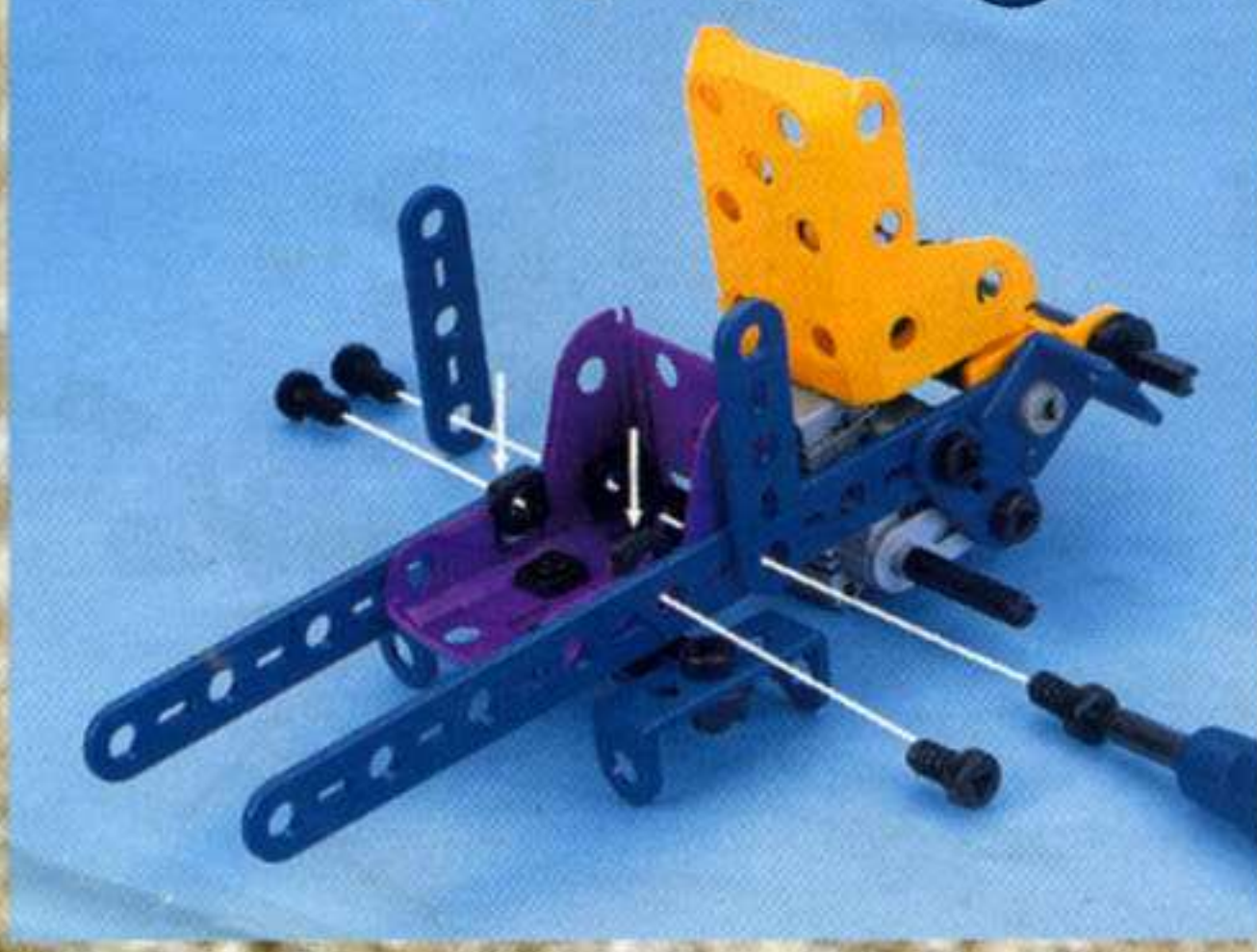

7

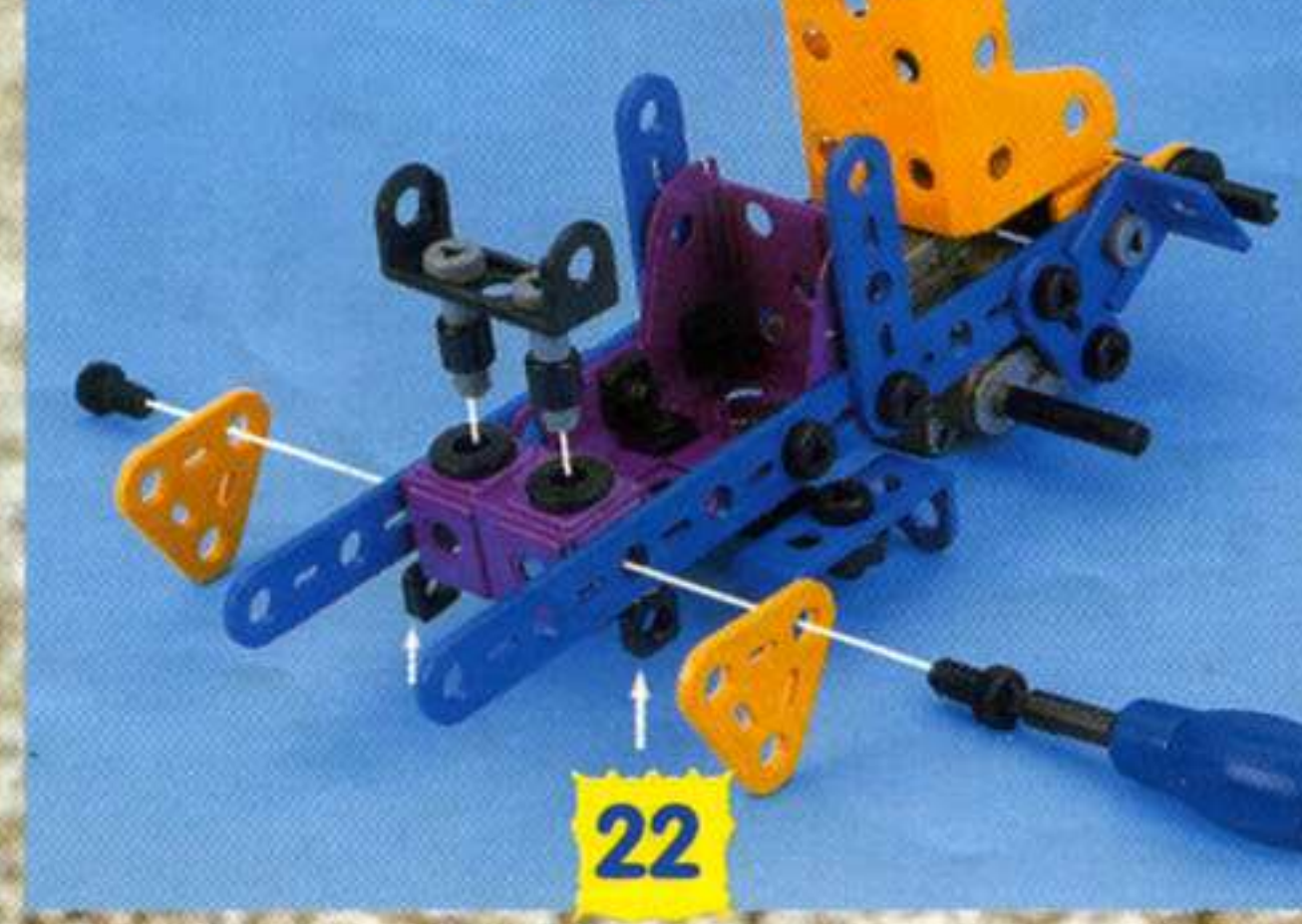

8

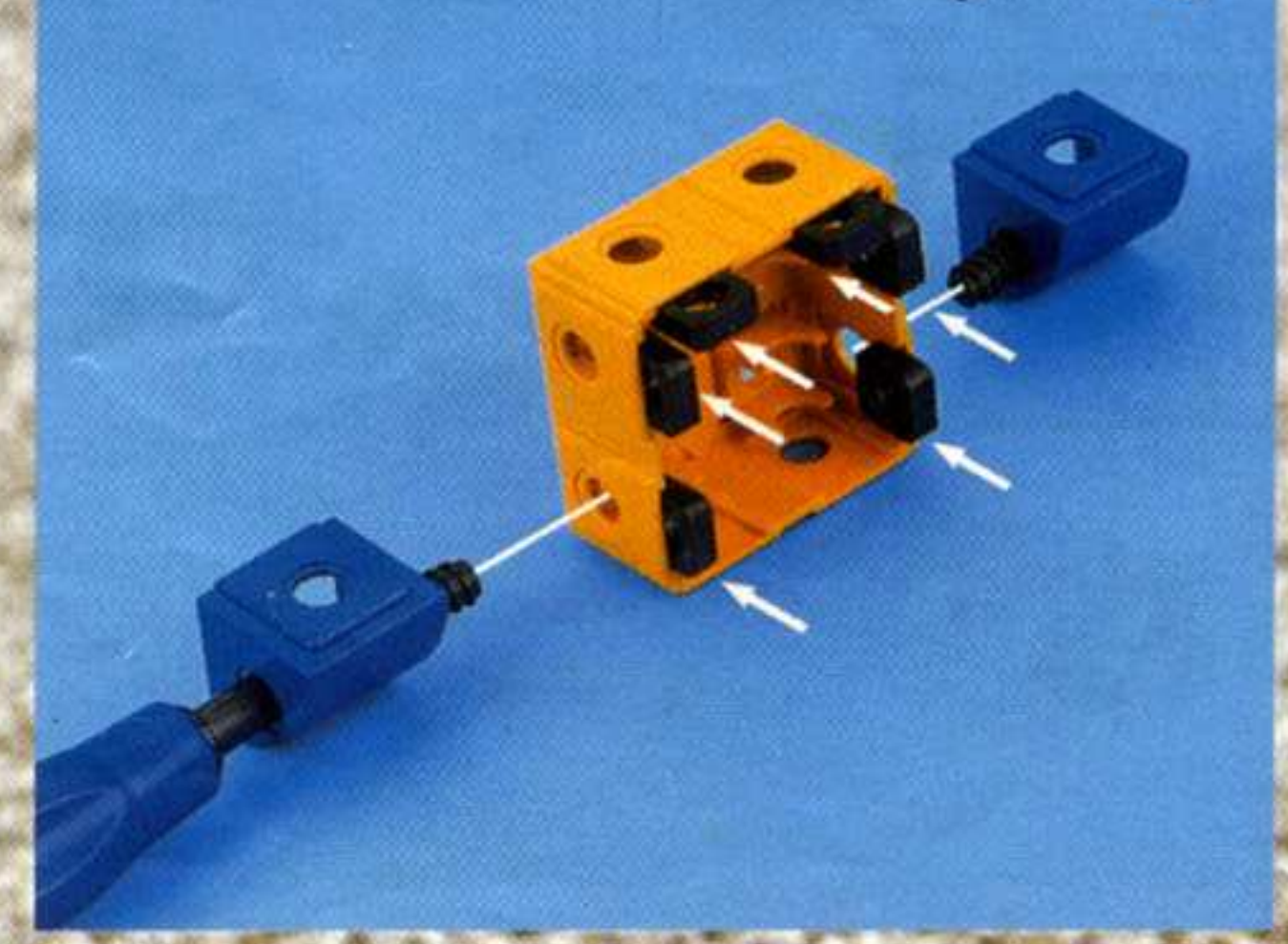

22

15

16

17

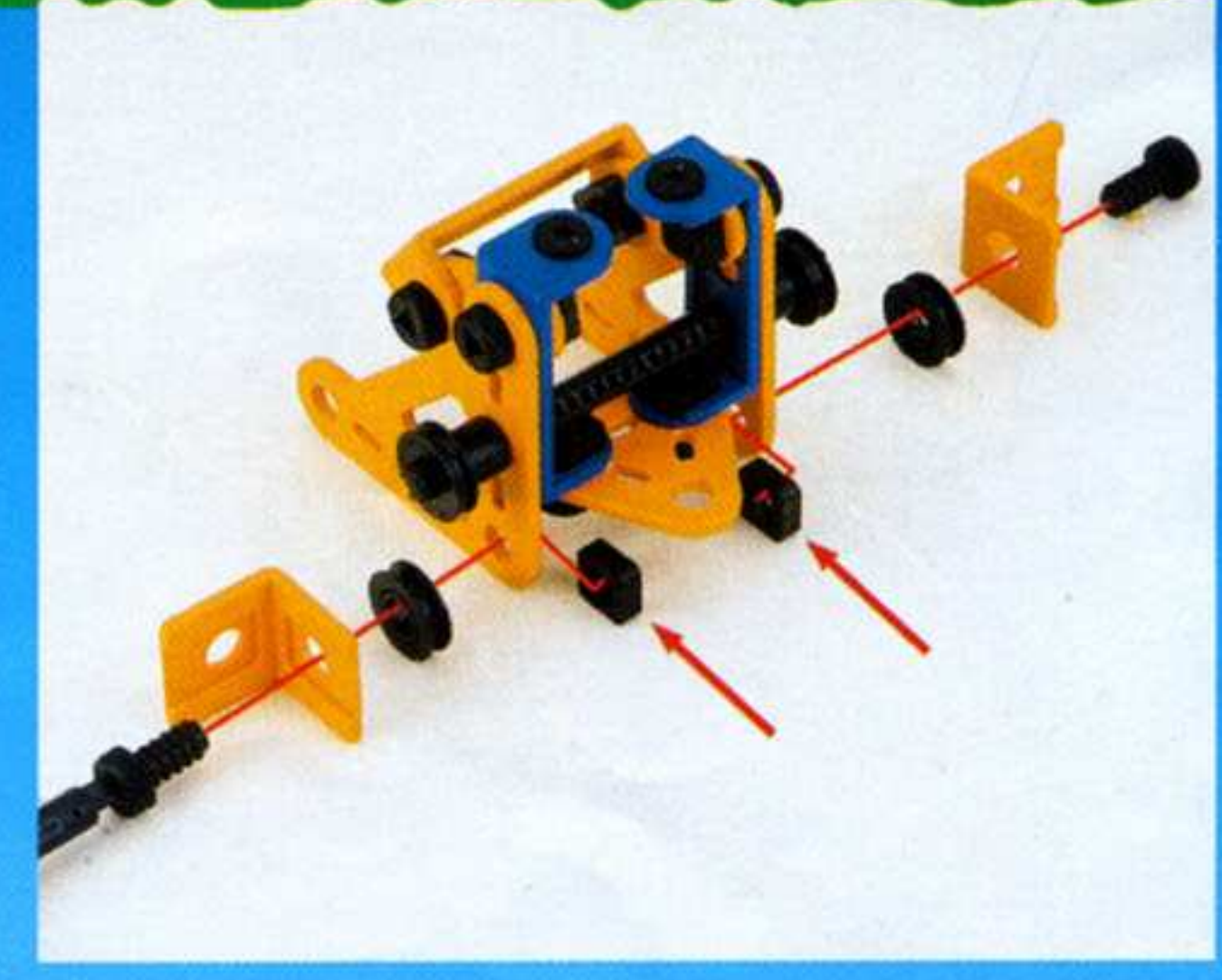
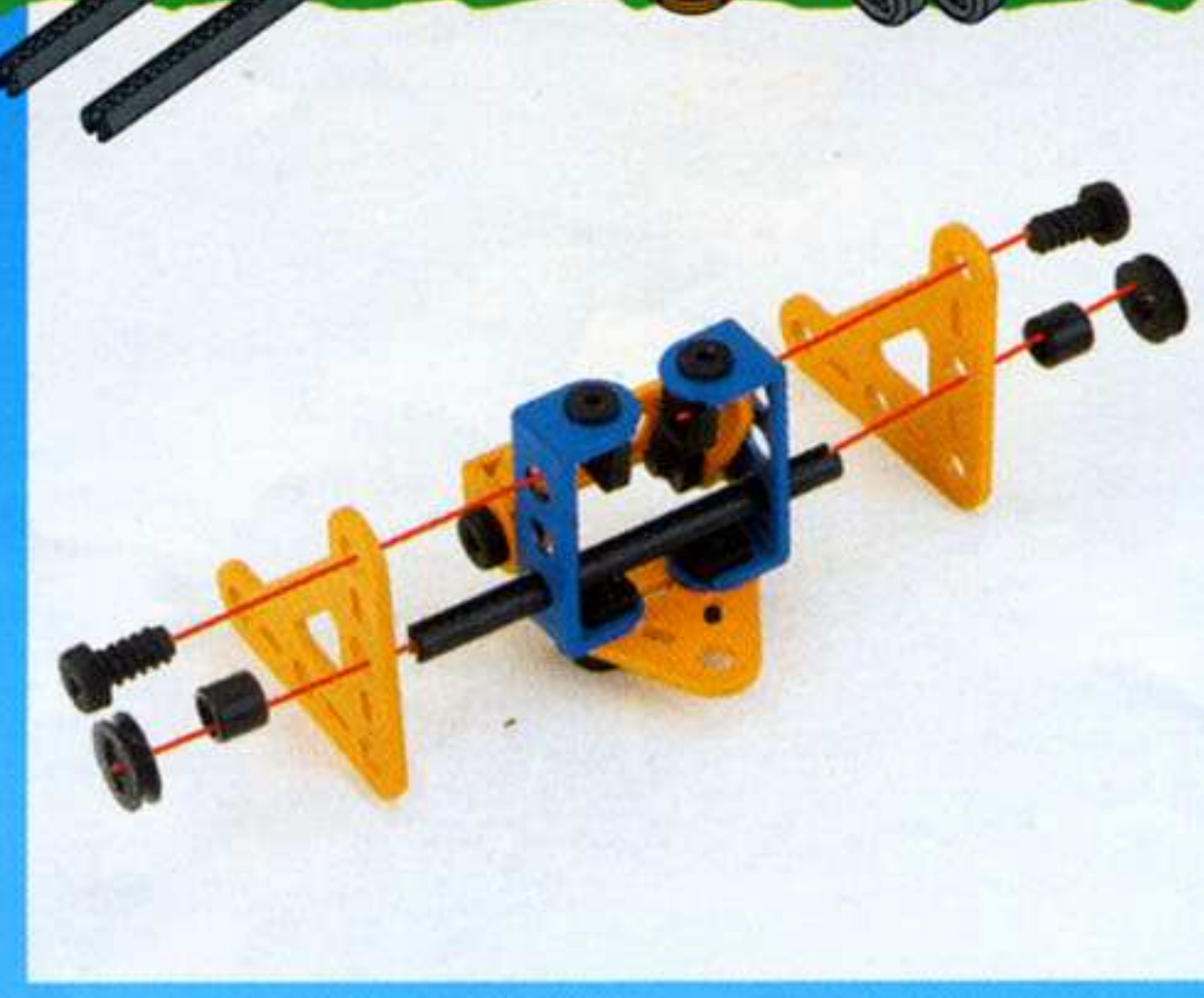
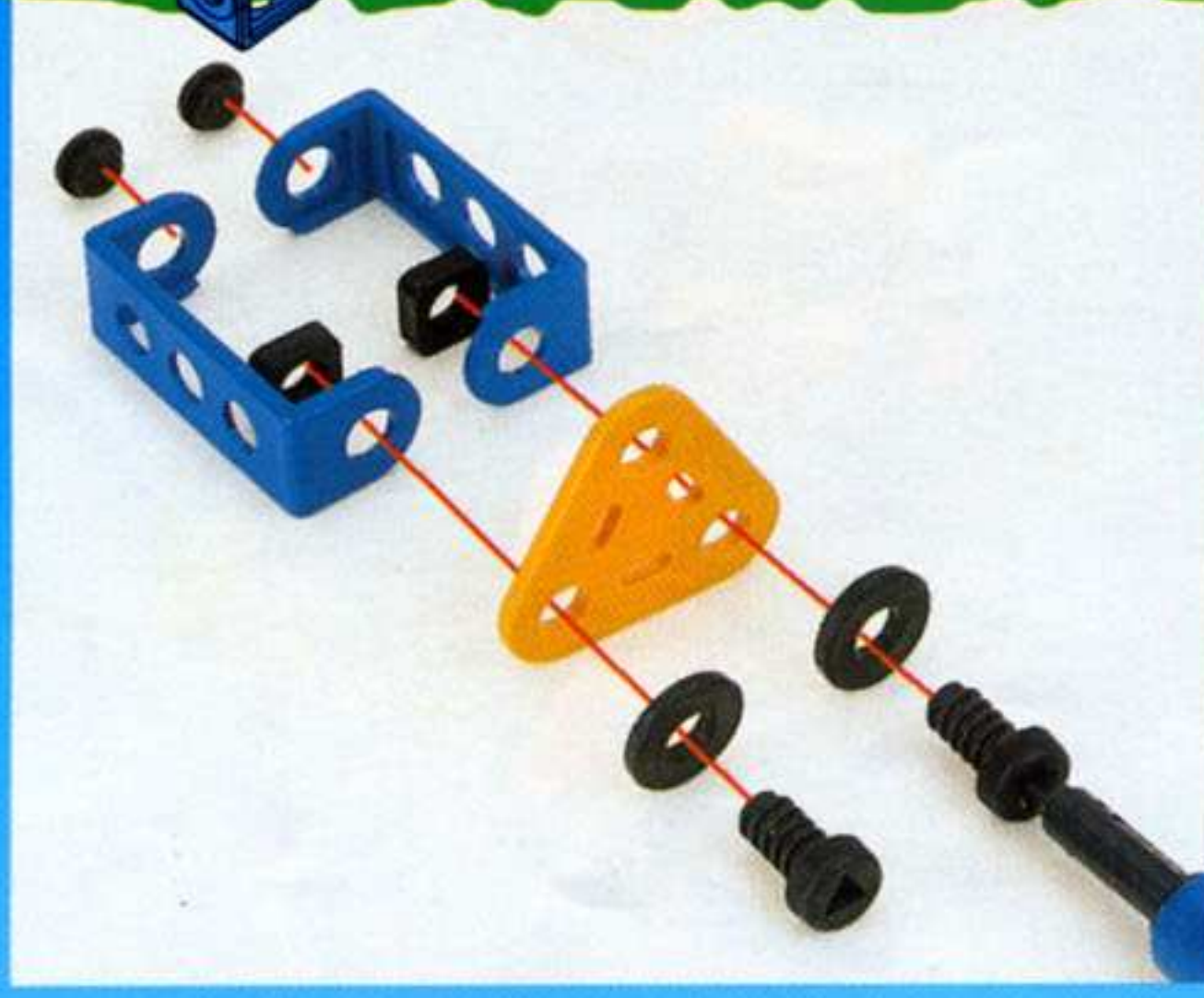

21



3

4

5

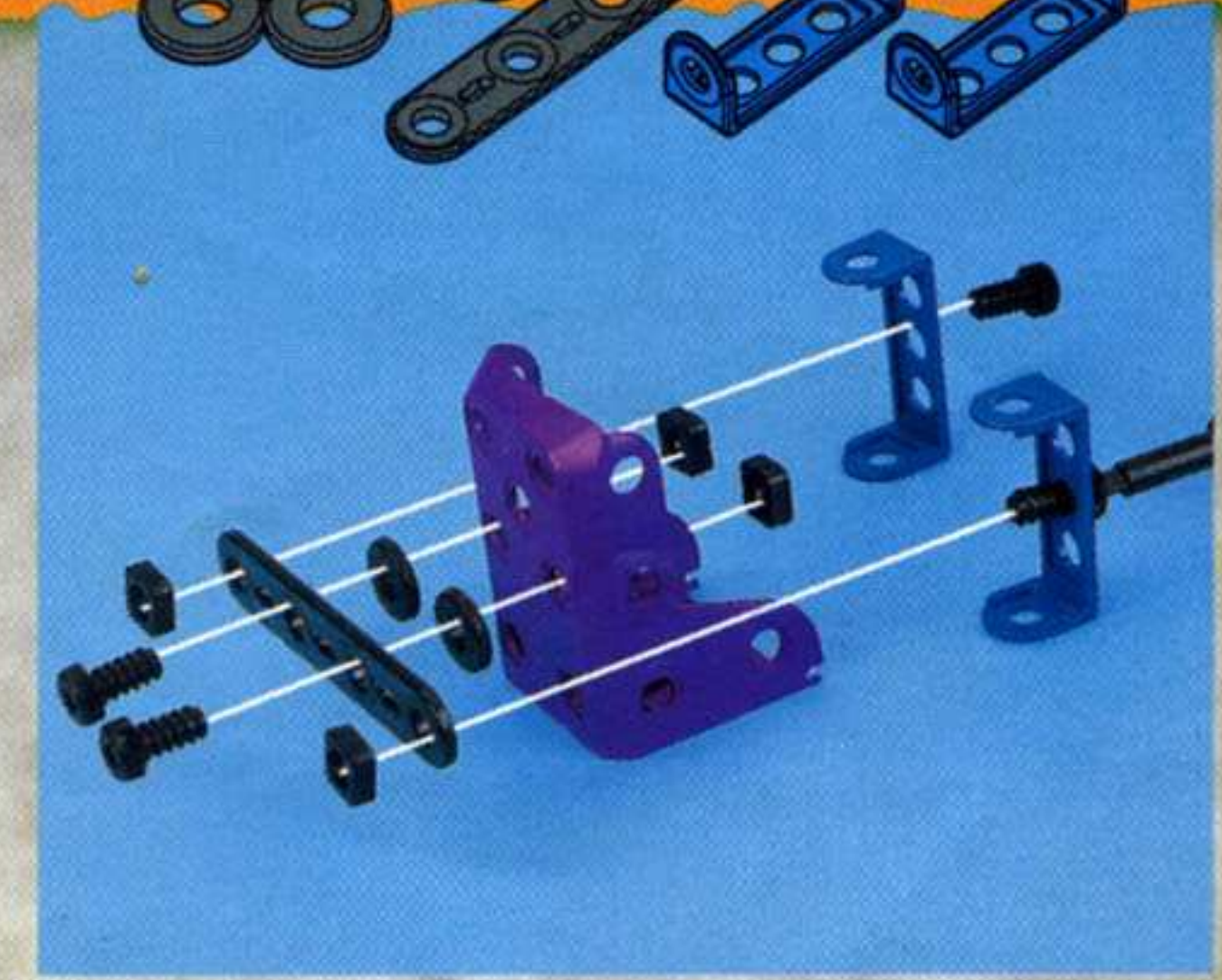
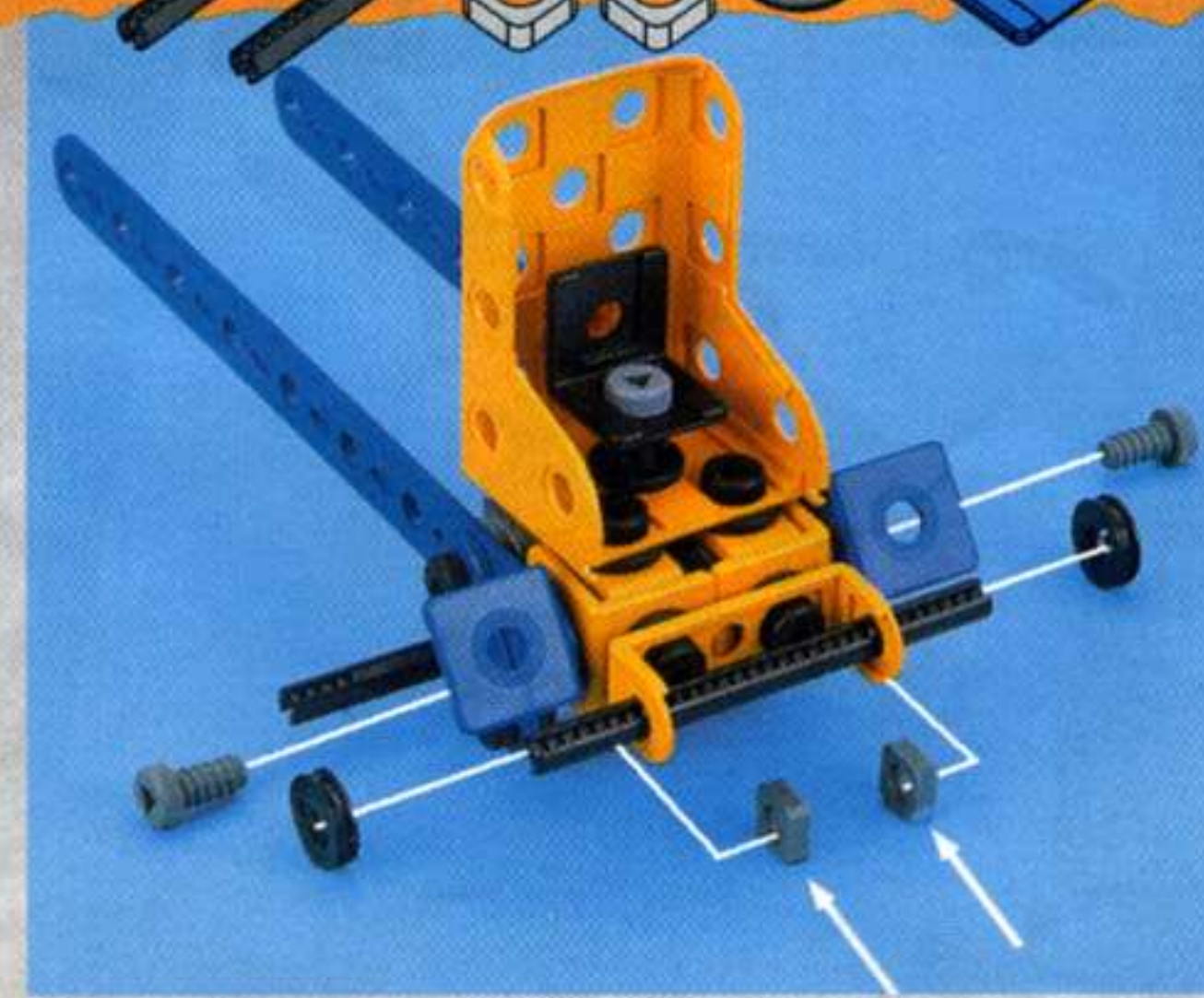
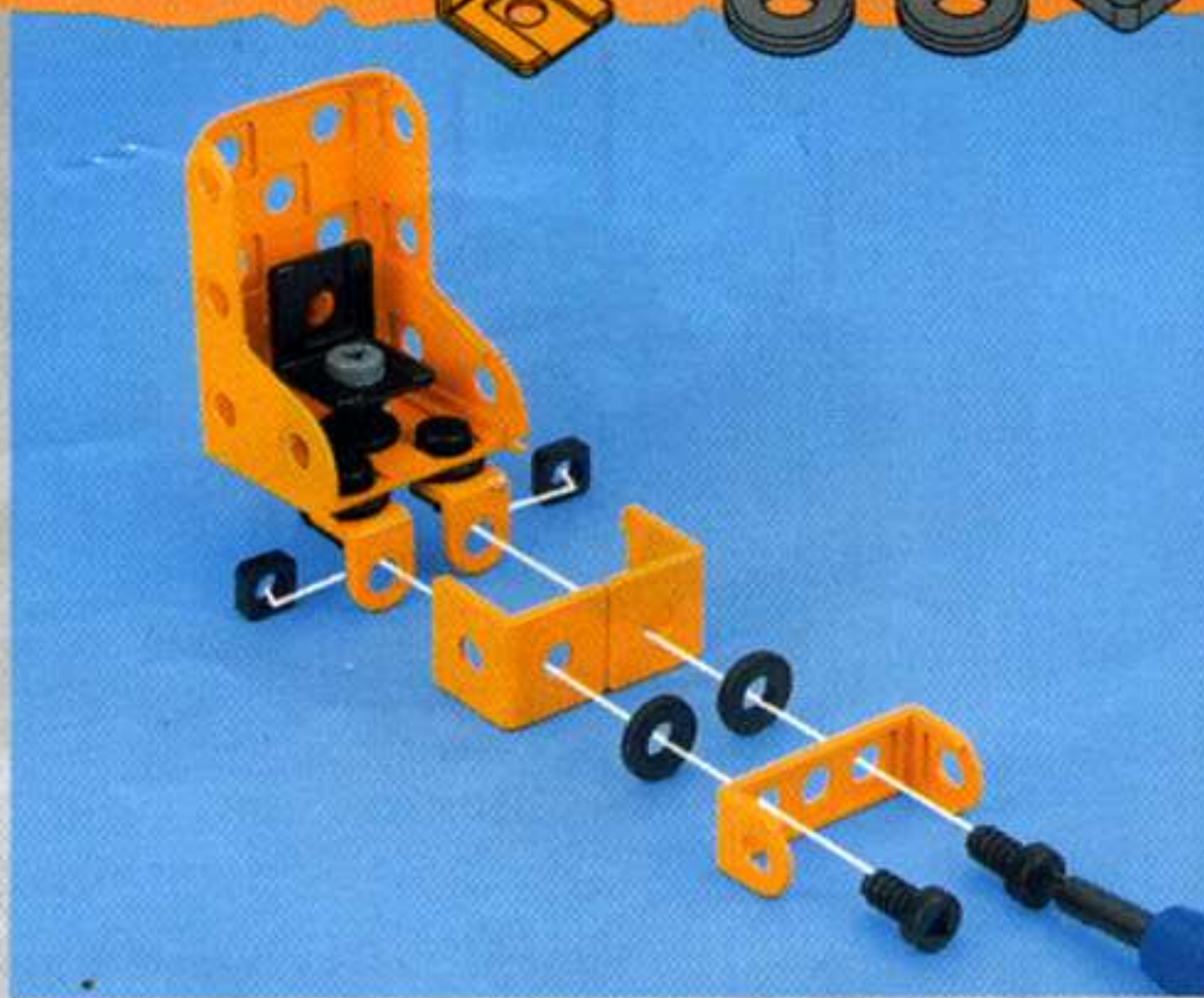

9

10

11

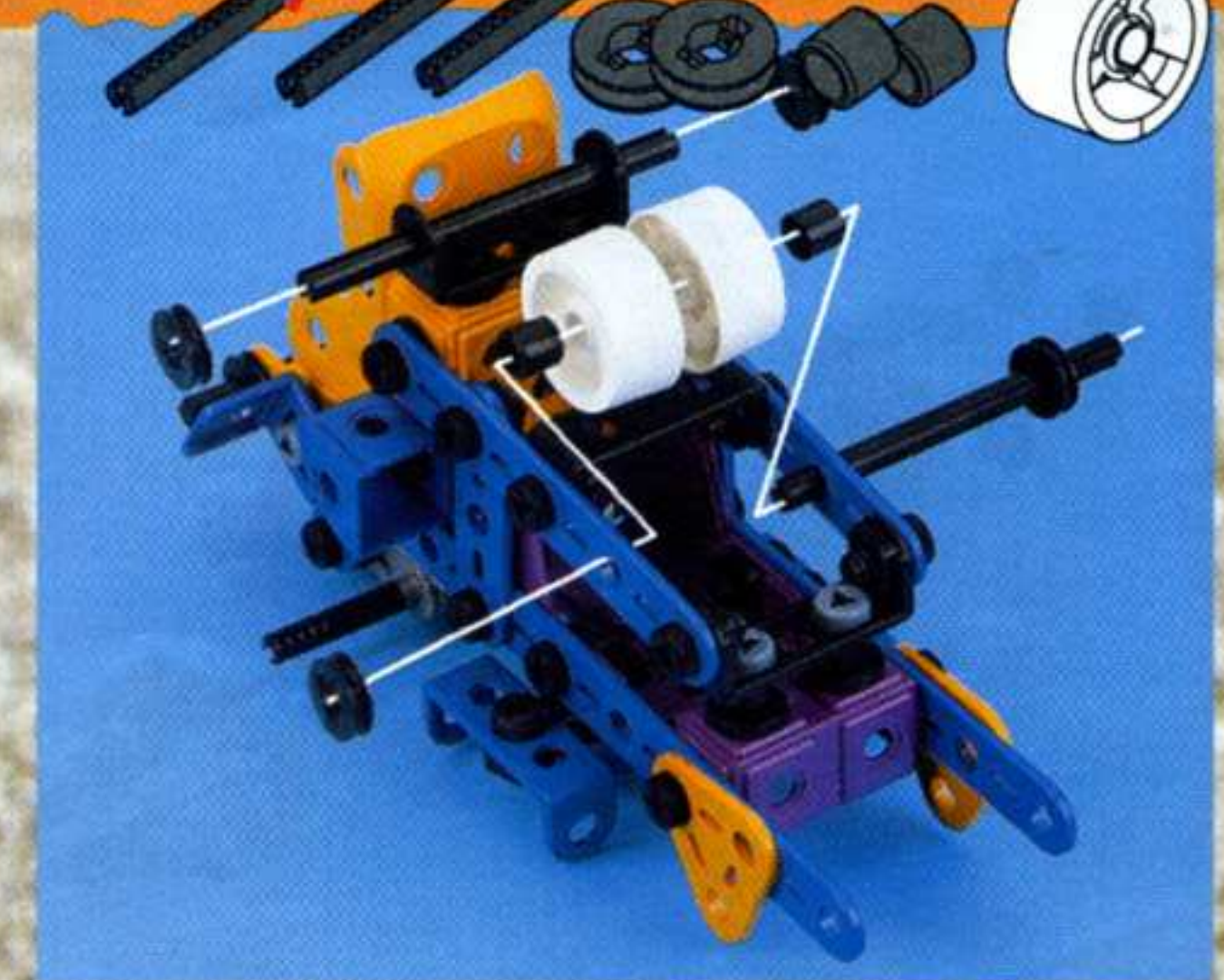
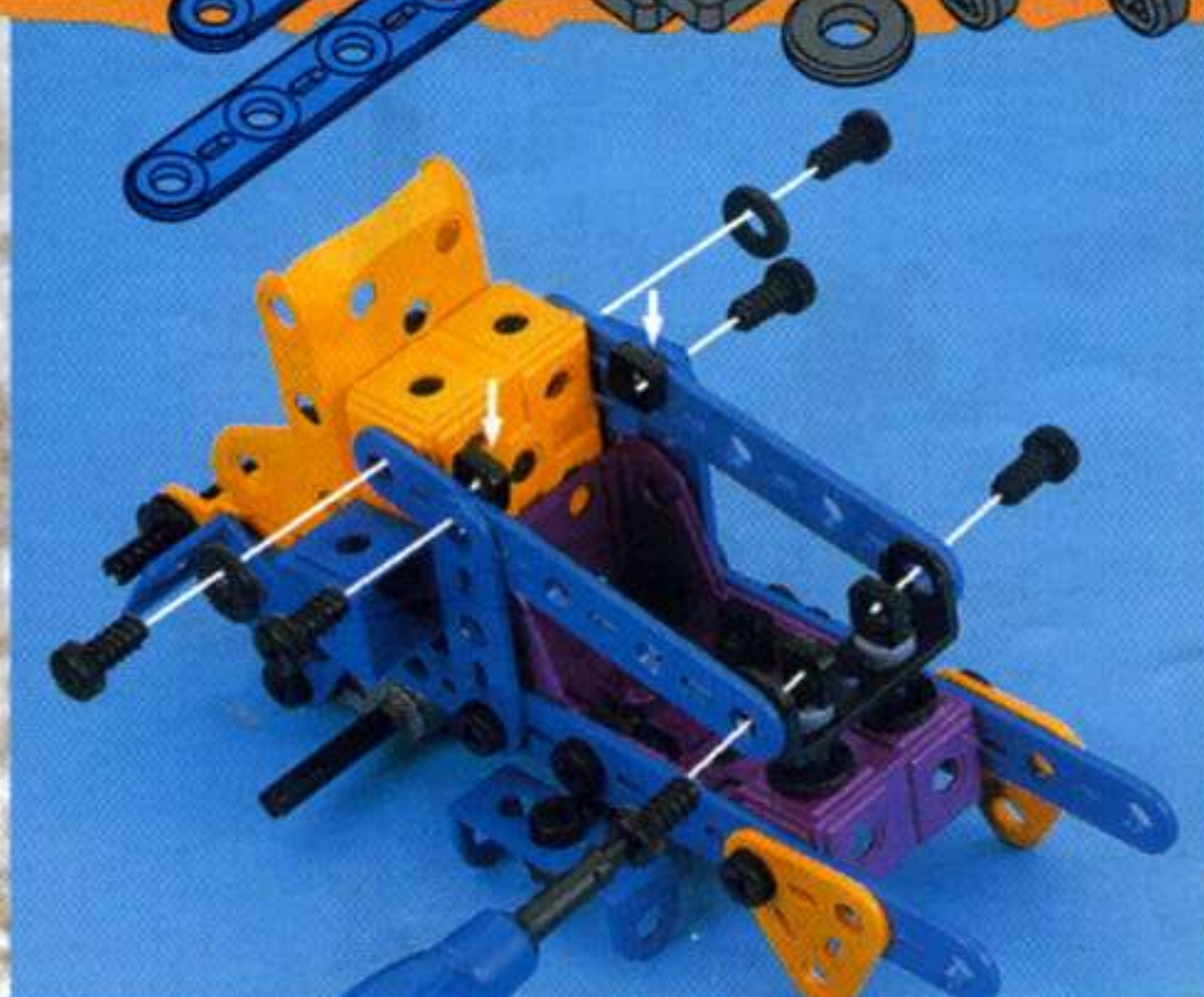

23

12

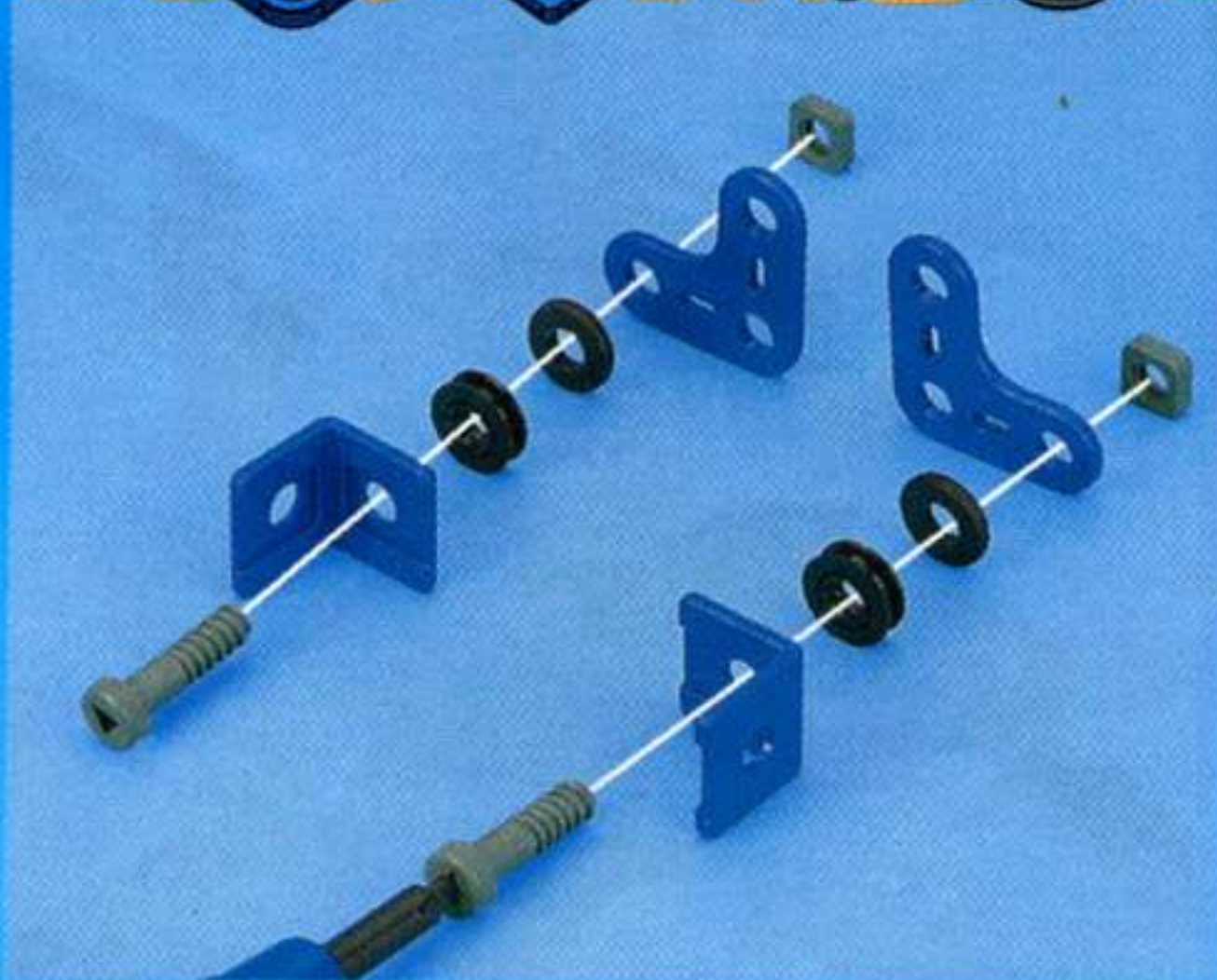
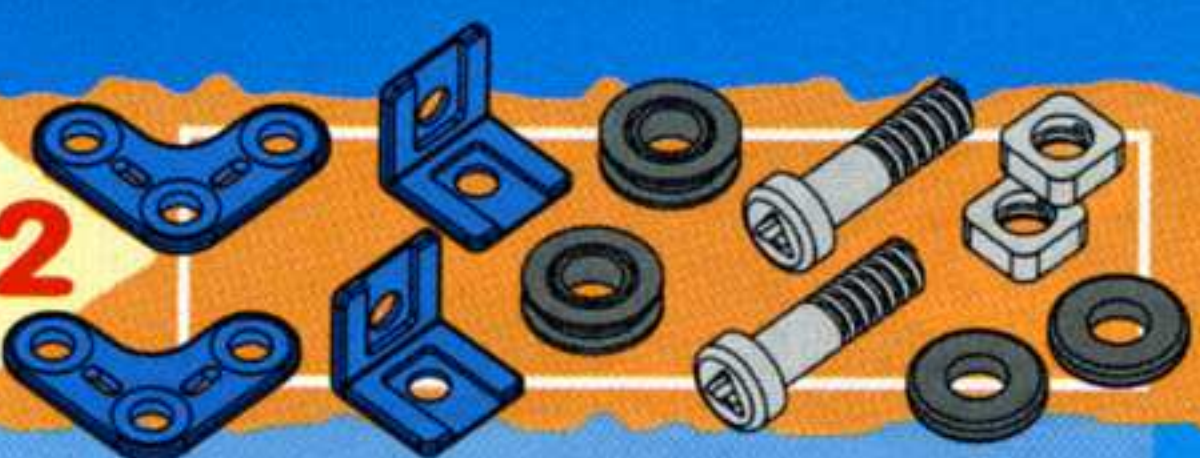

13



14

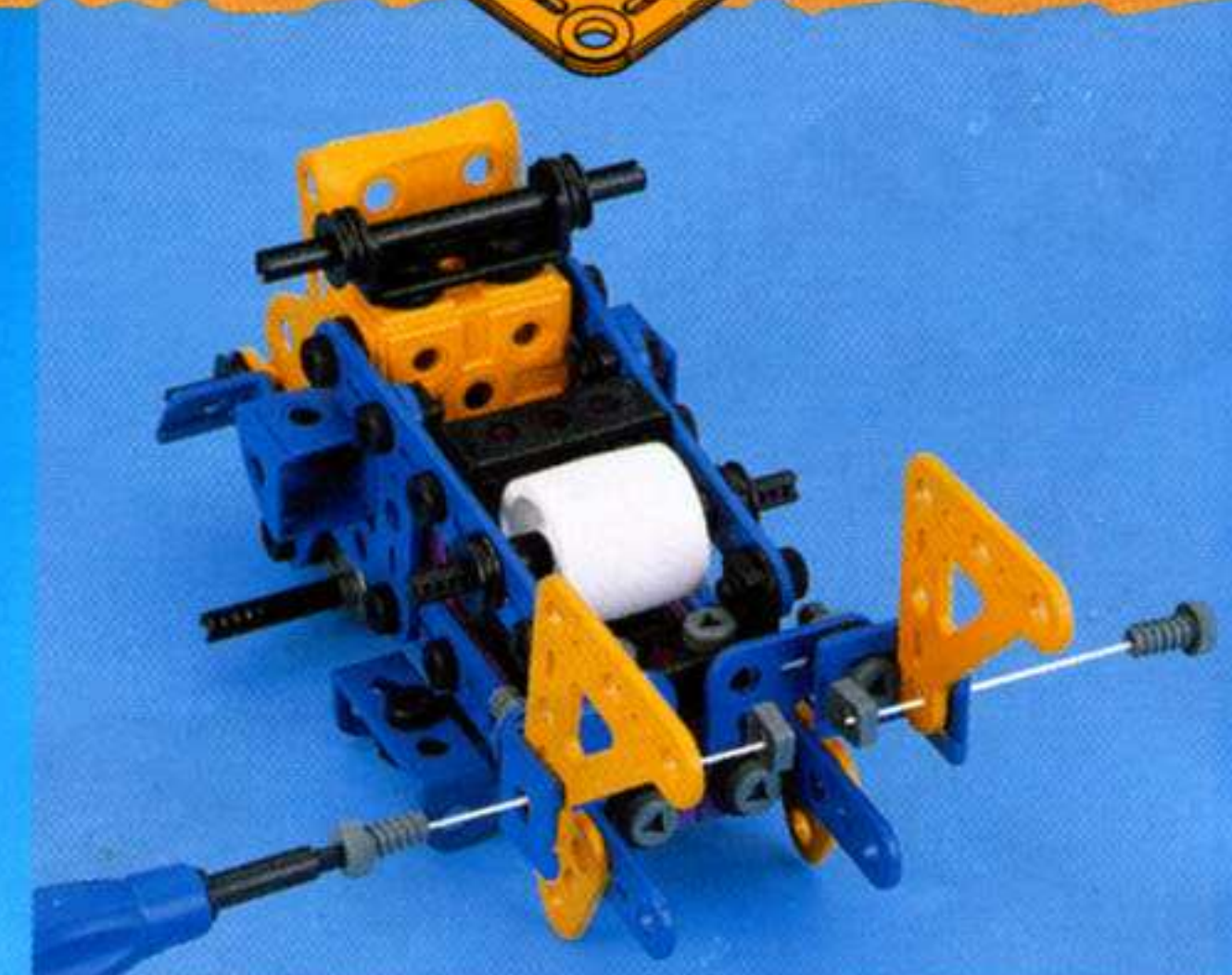
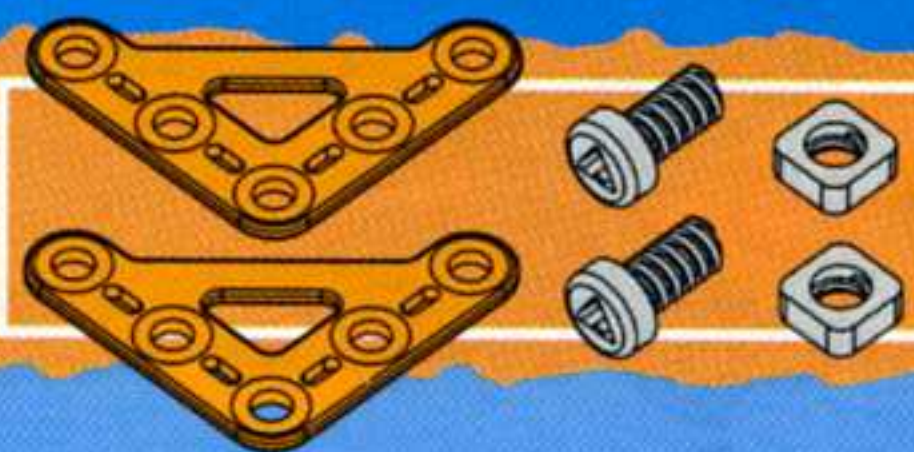

18

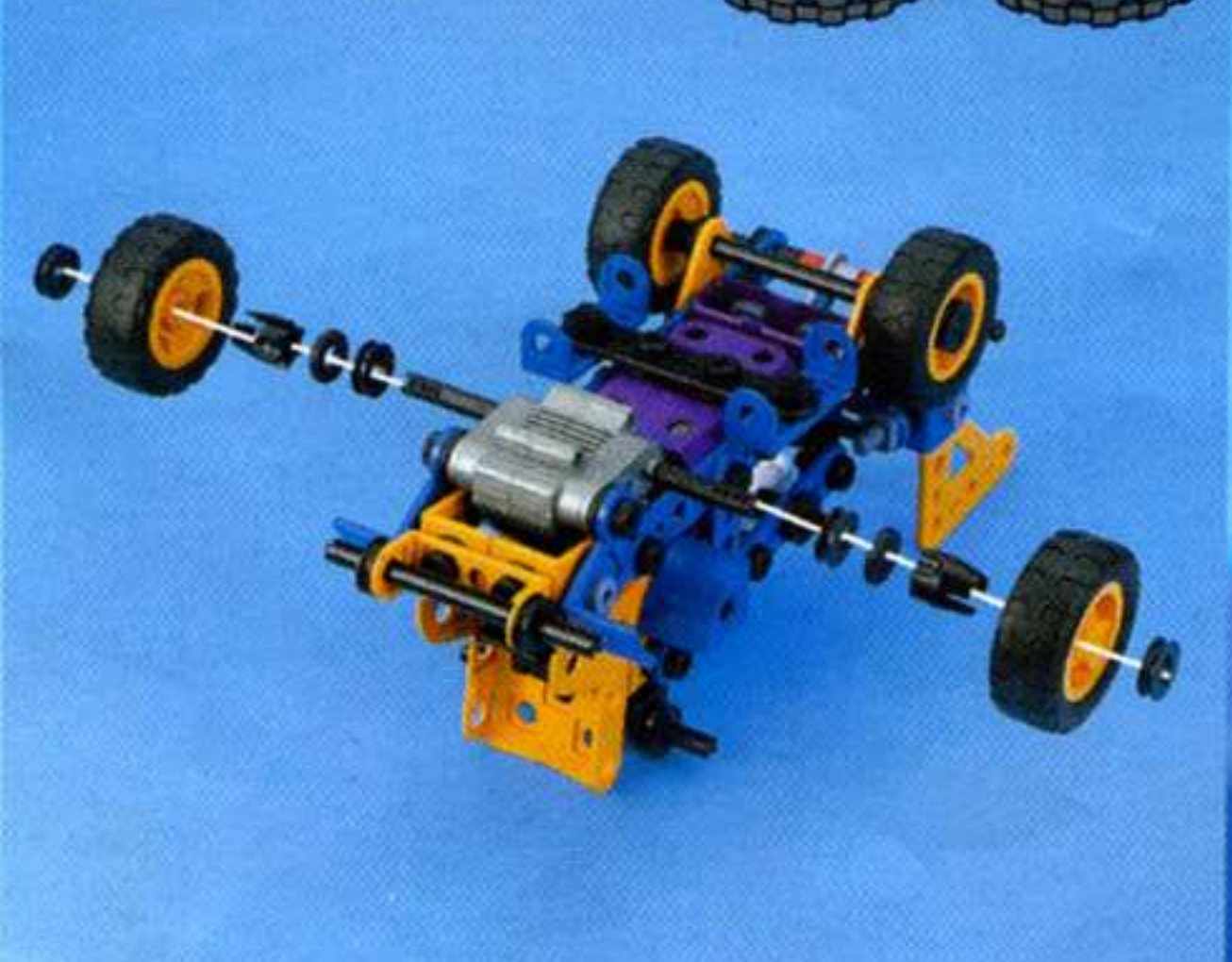
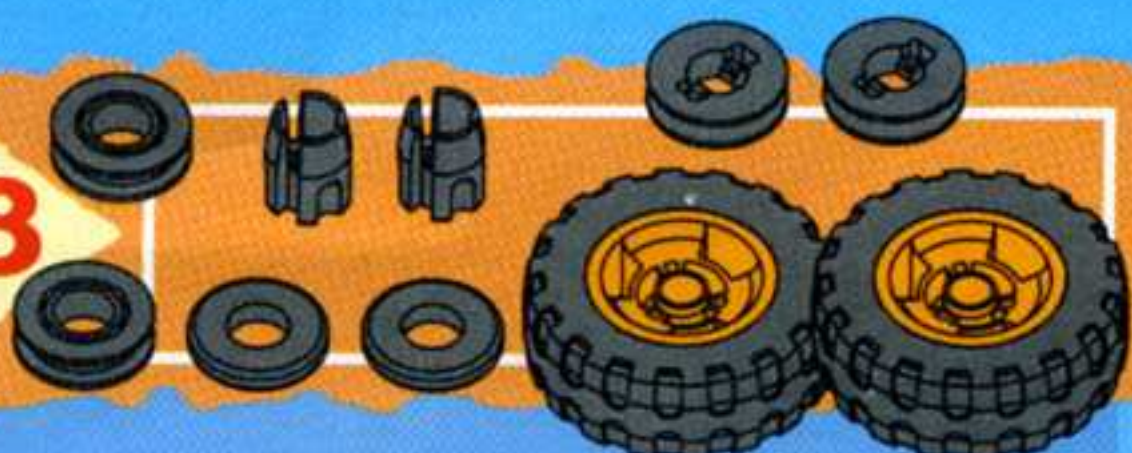

19

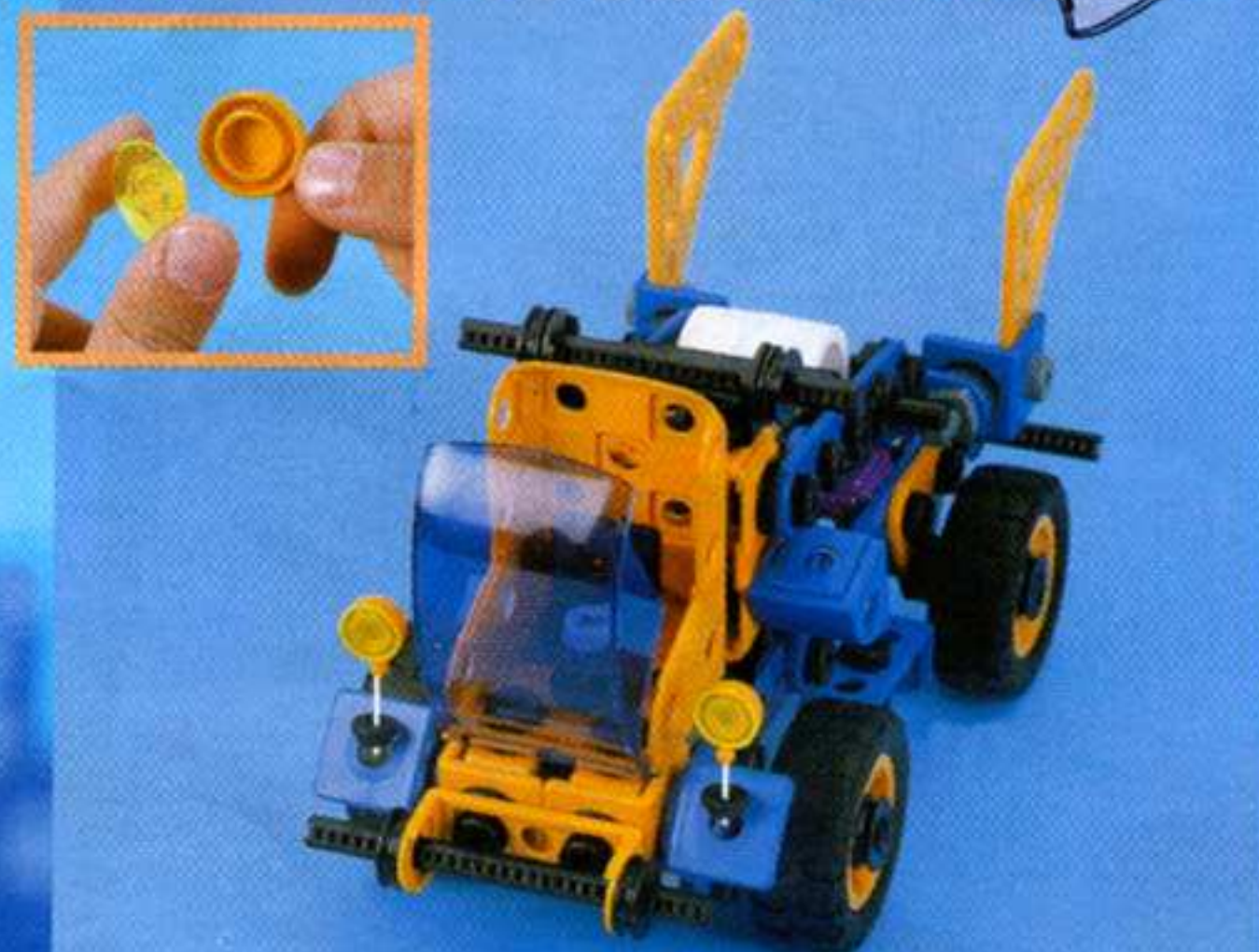
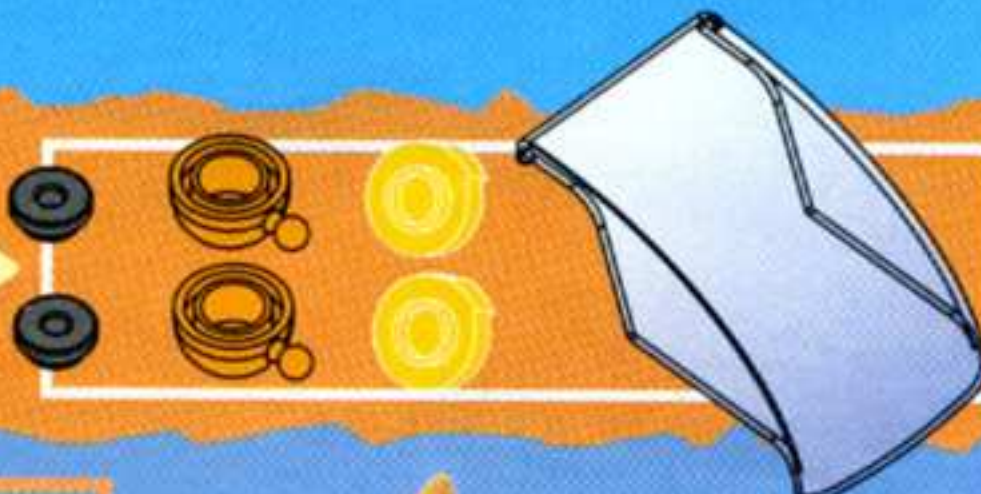

20

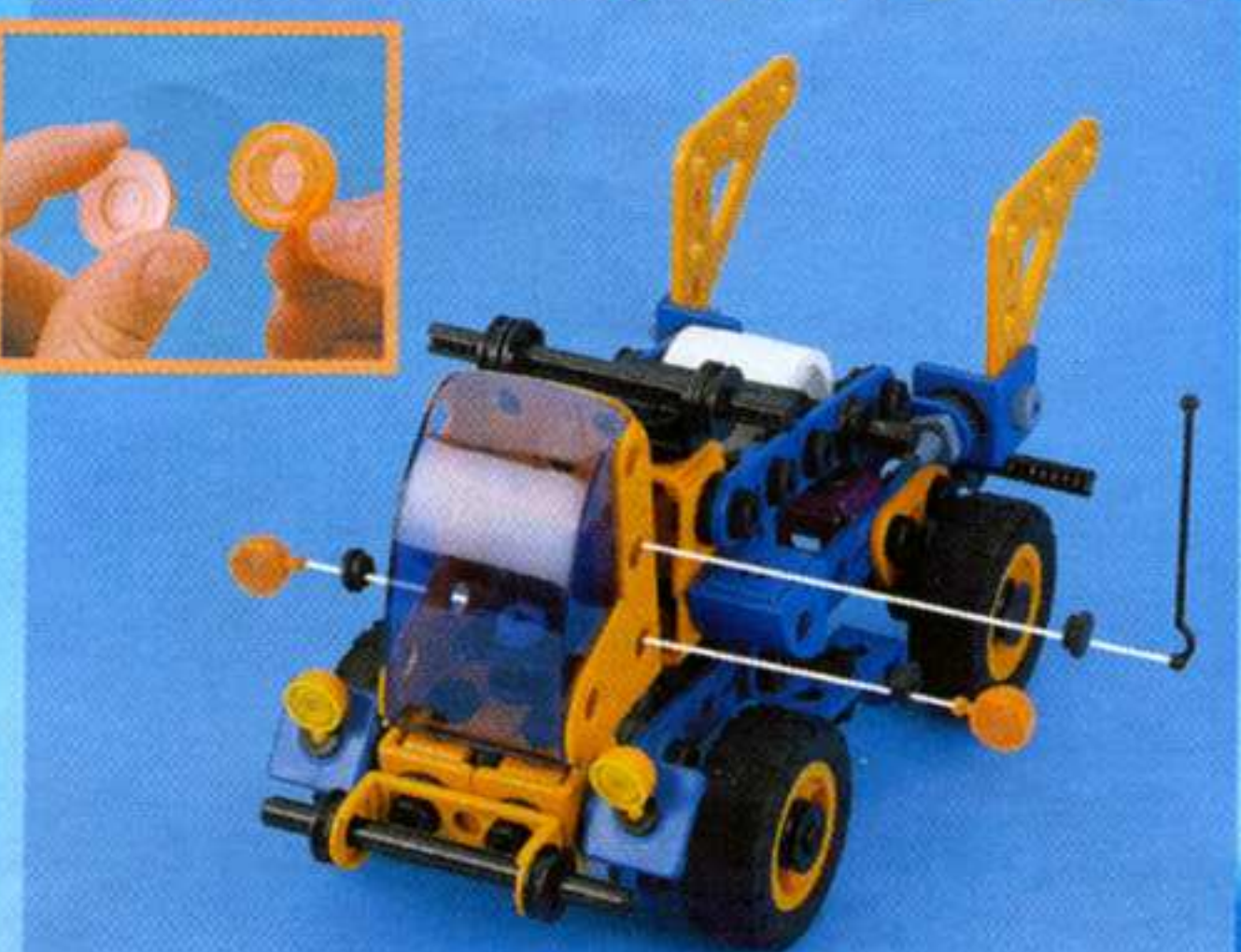

1



5

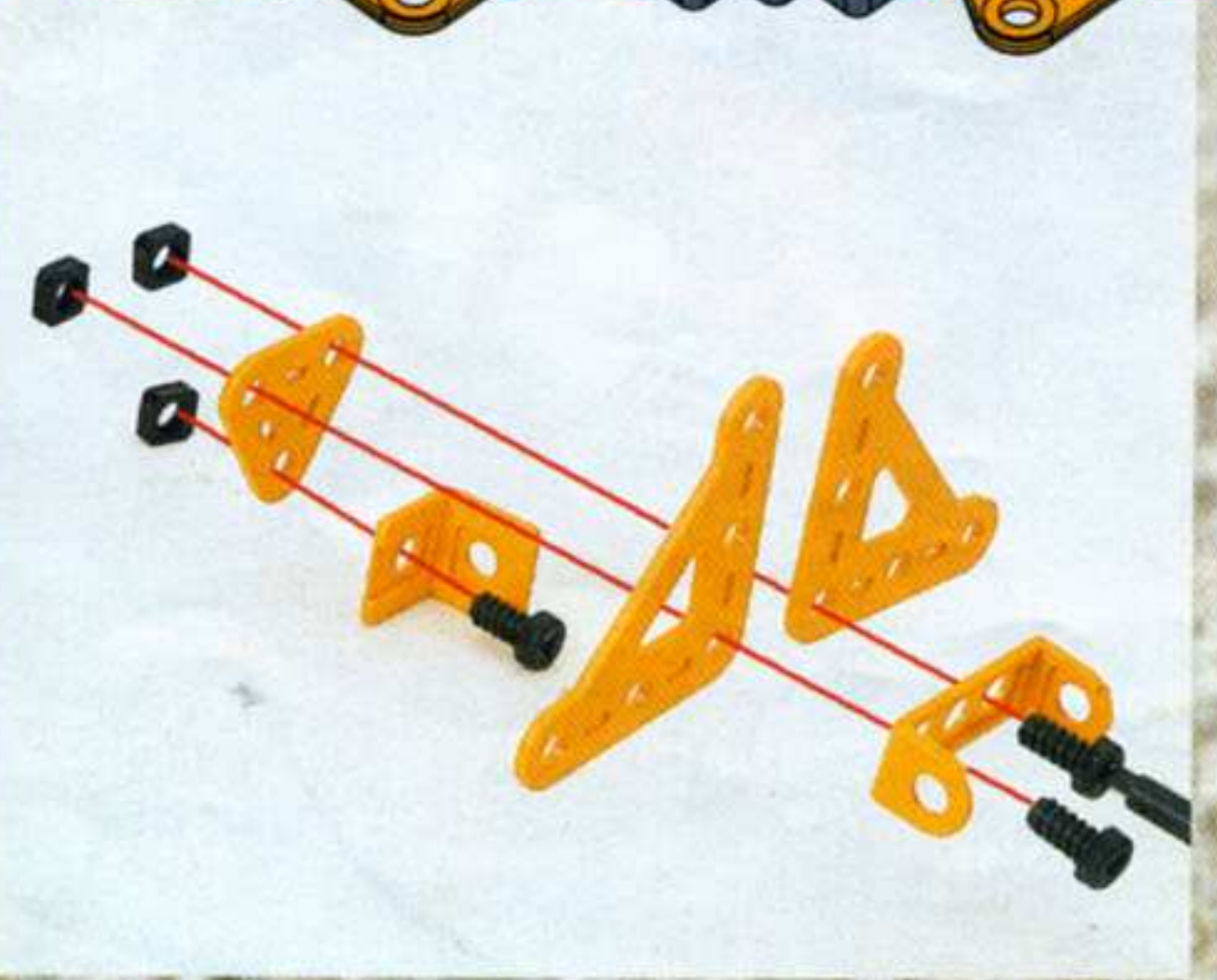

6



7





15



16

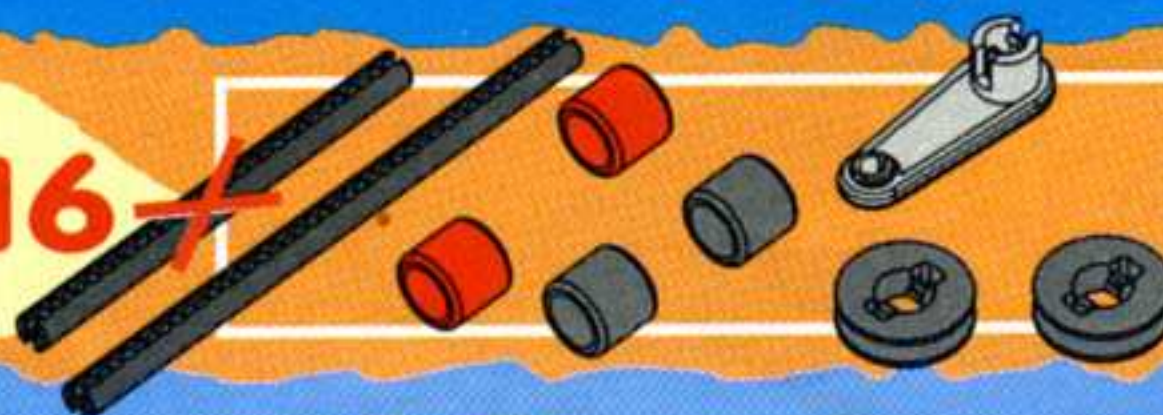

17

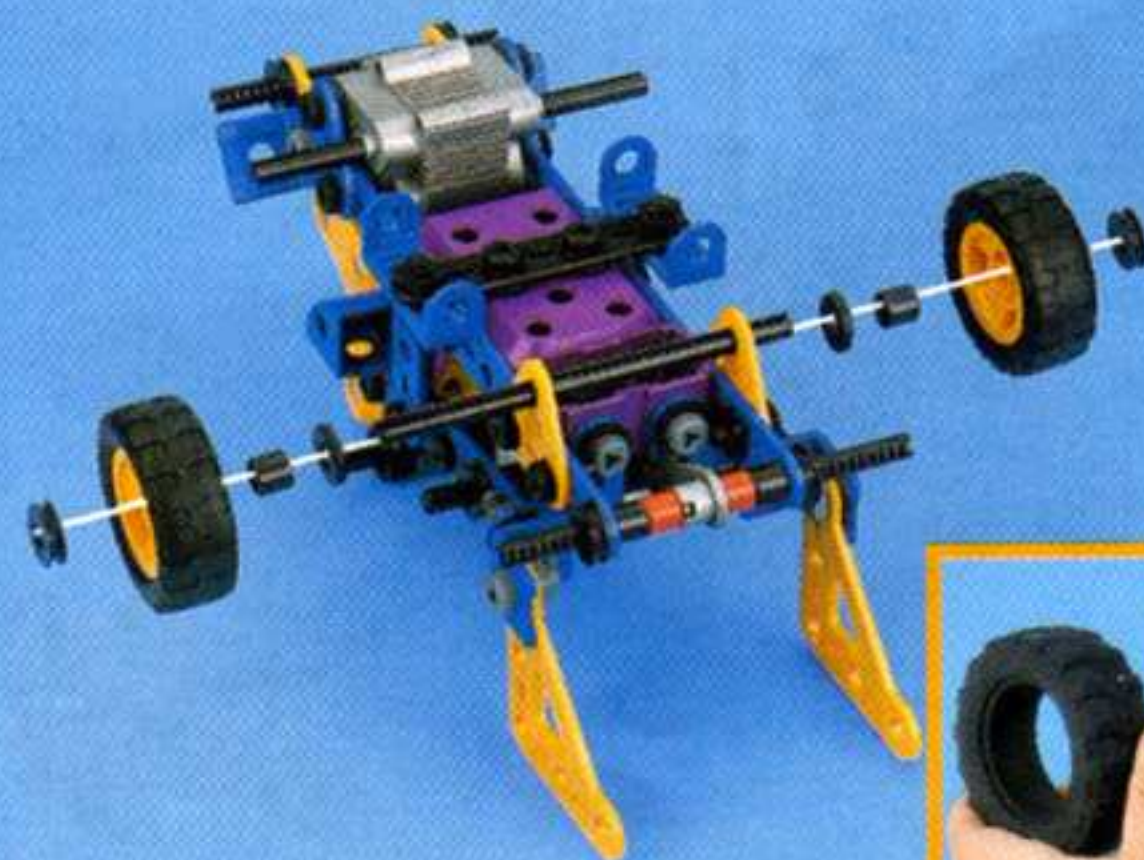
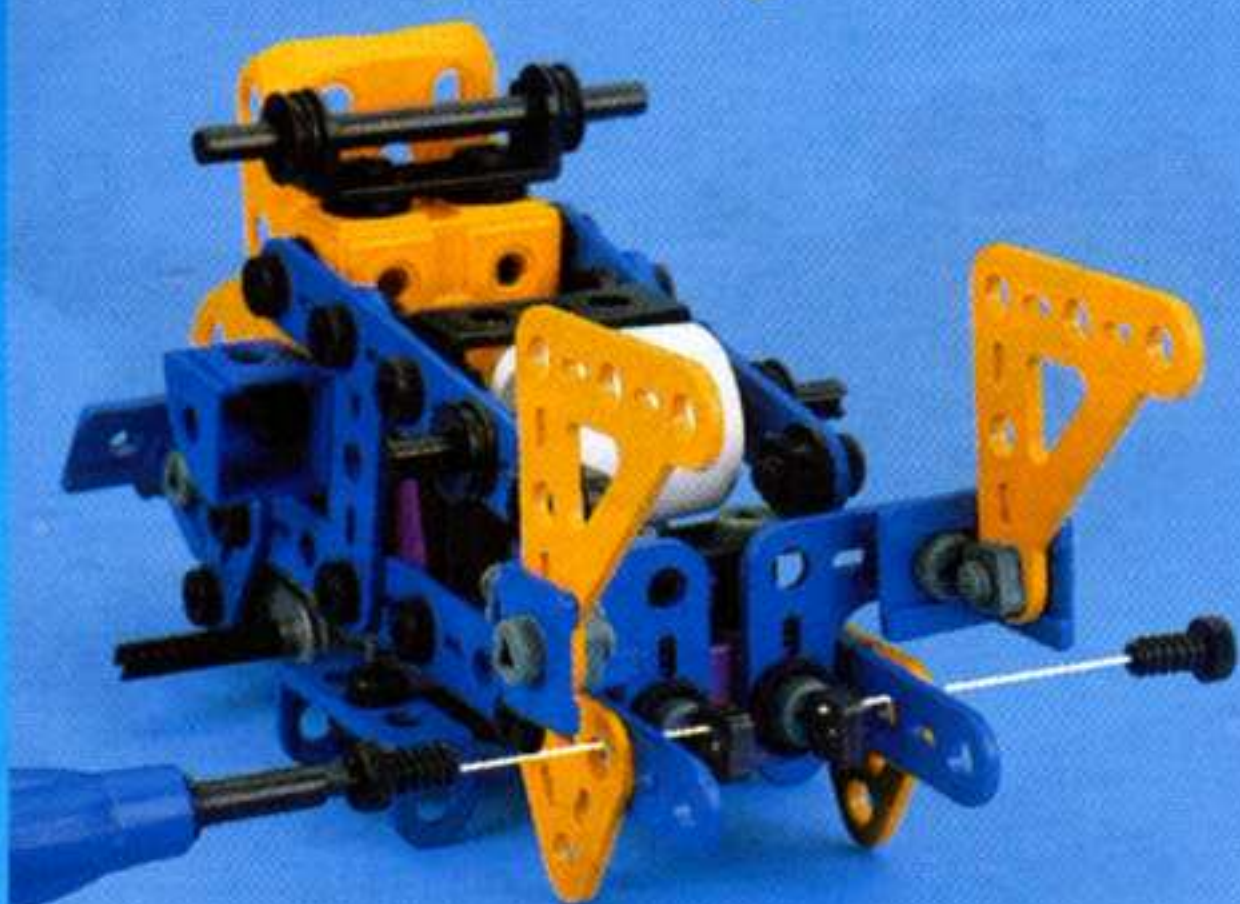
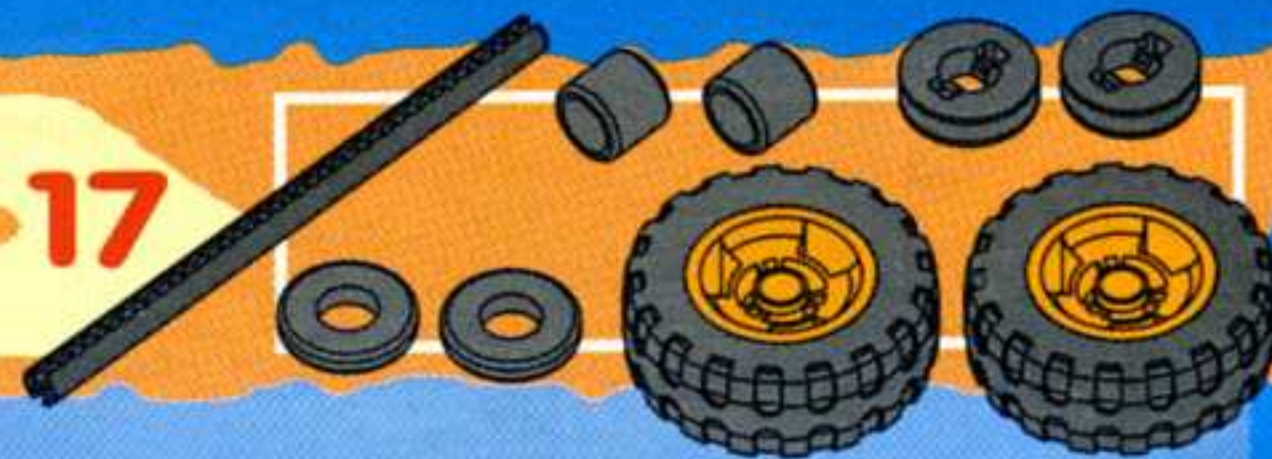

21



22



2



3



4

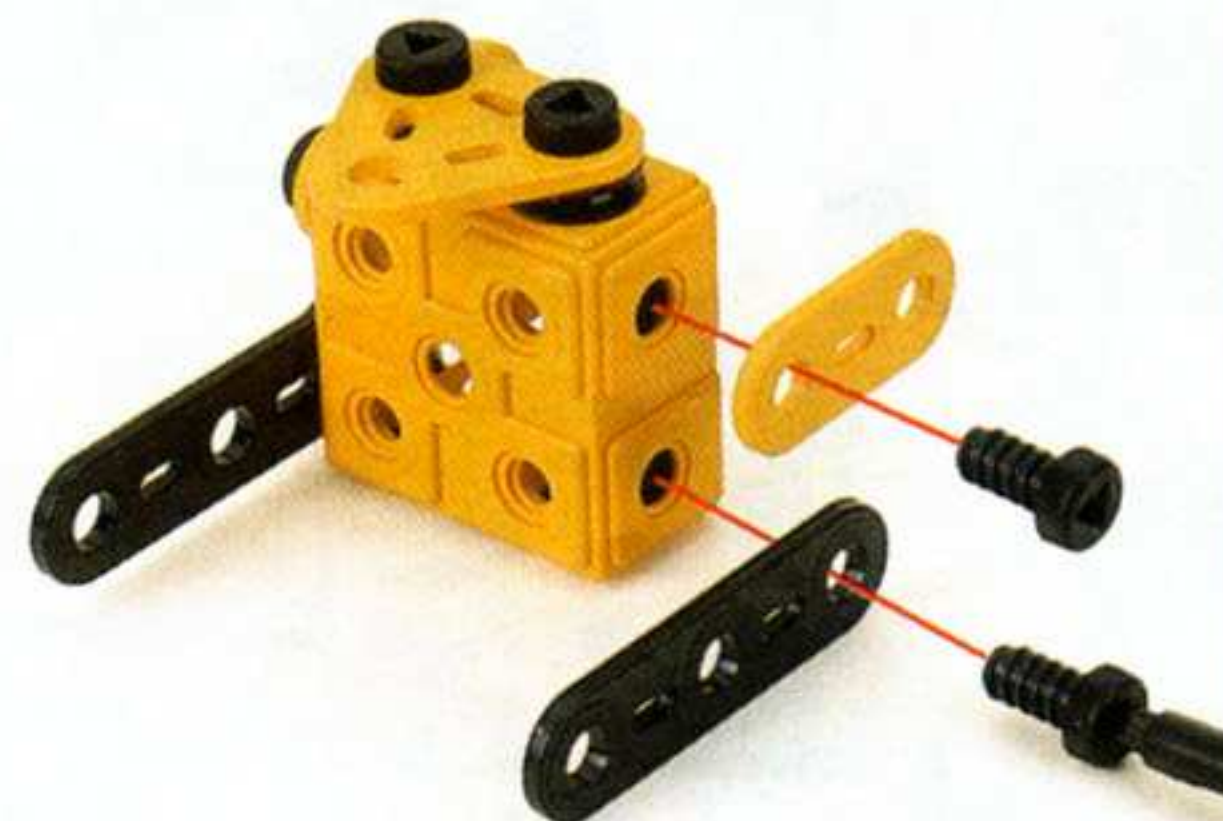
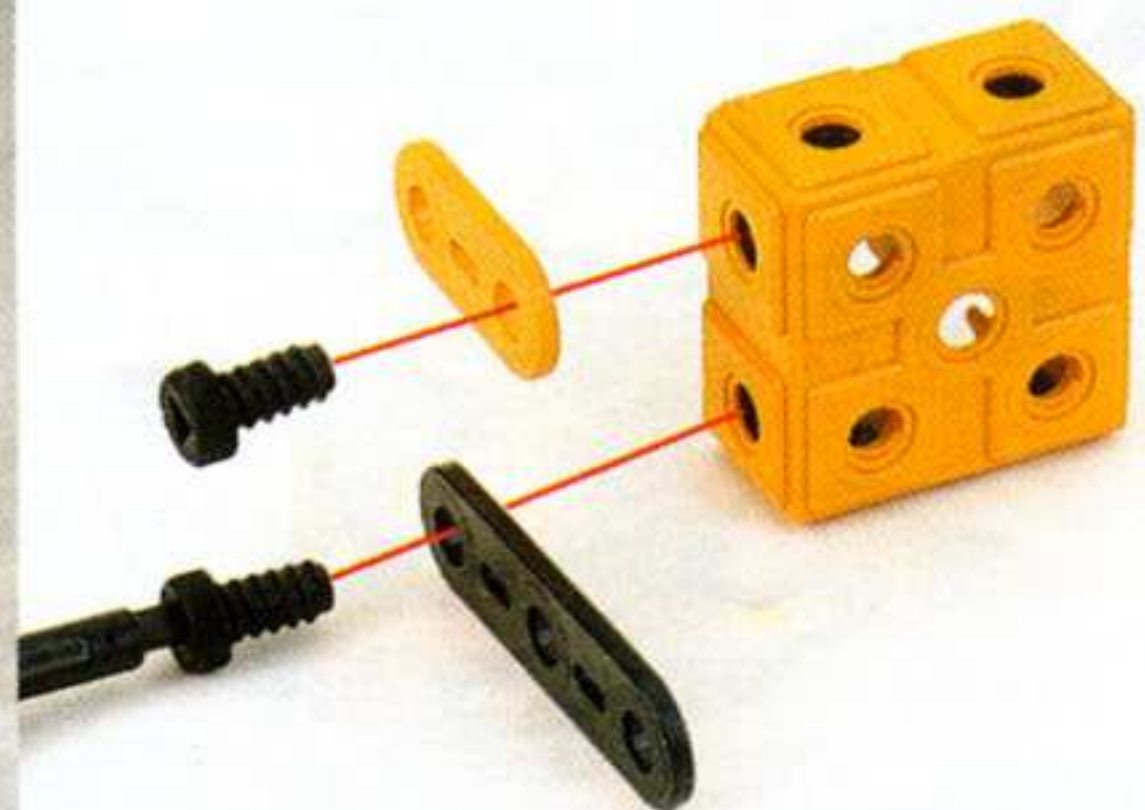

8



9

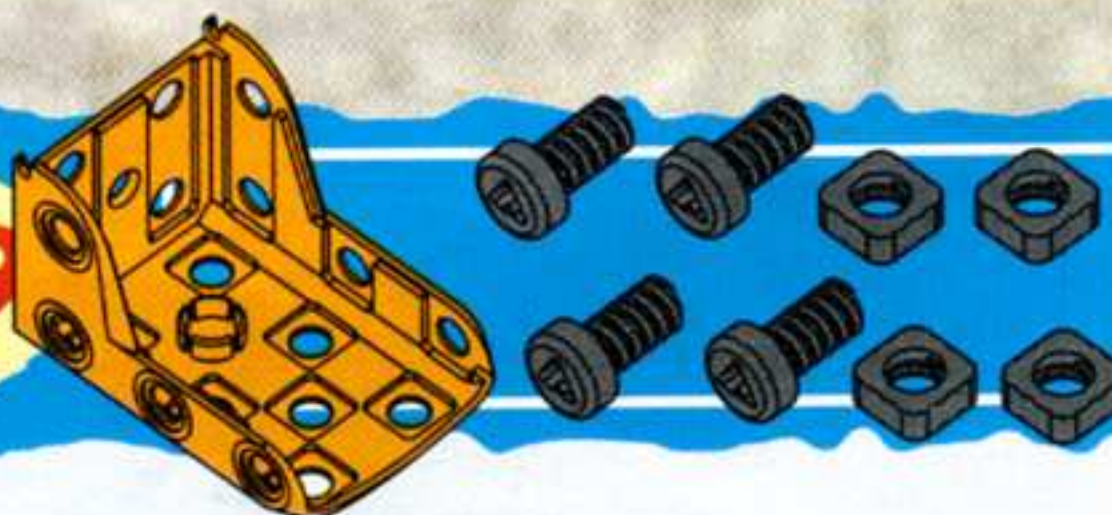

10

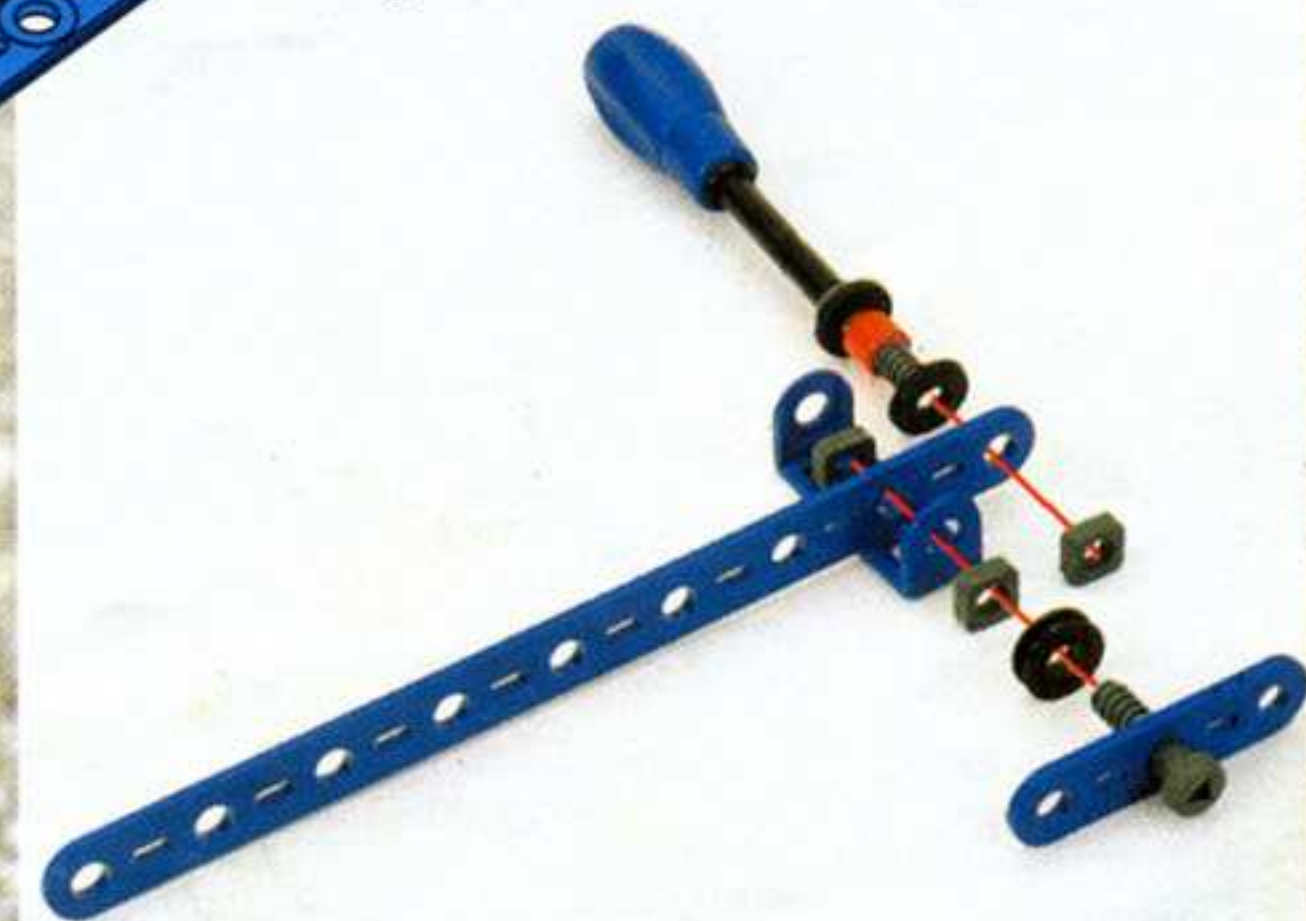
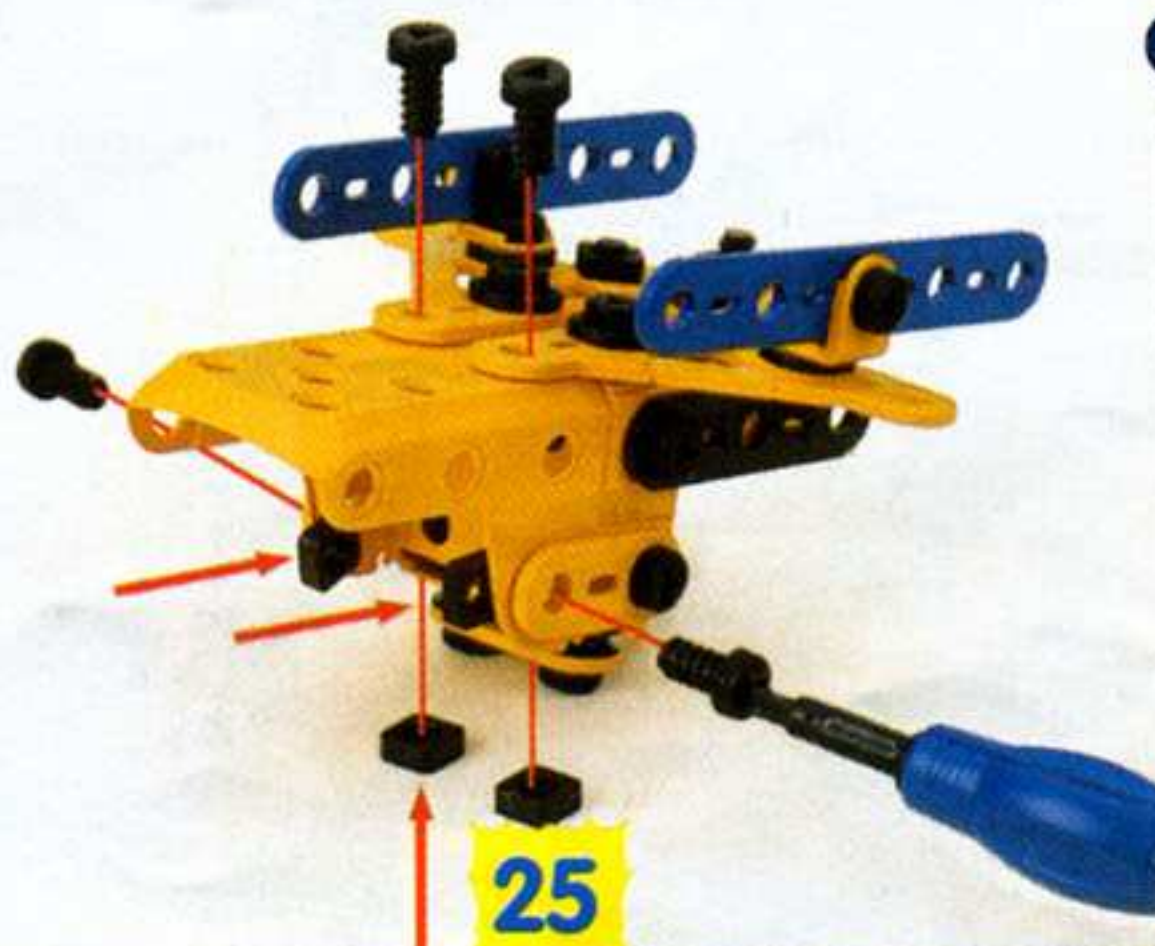
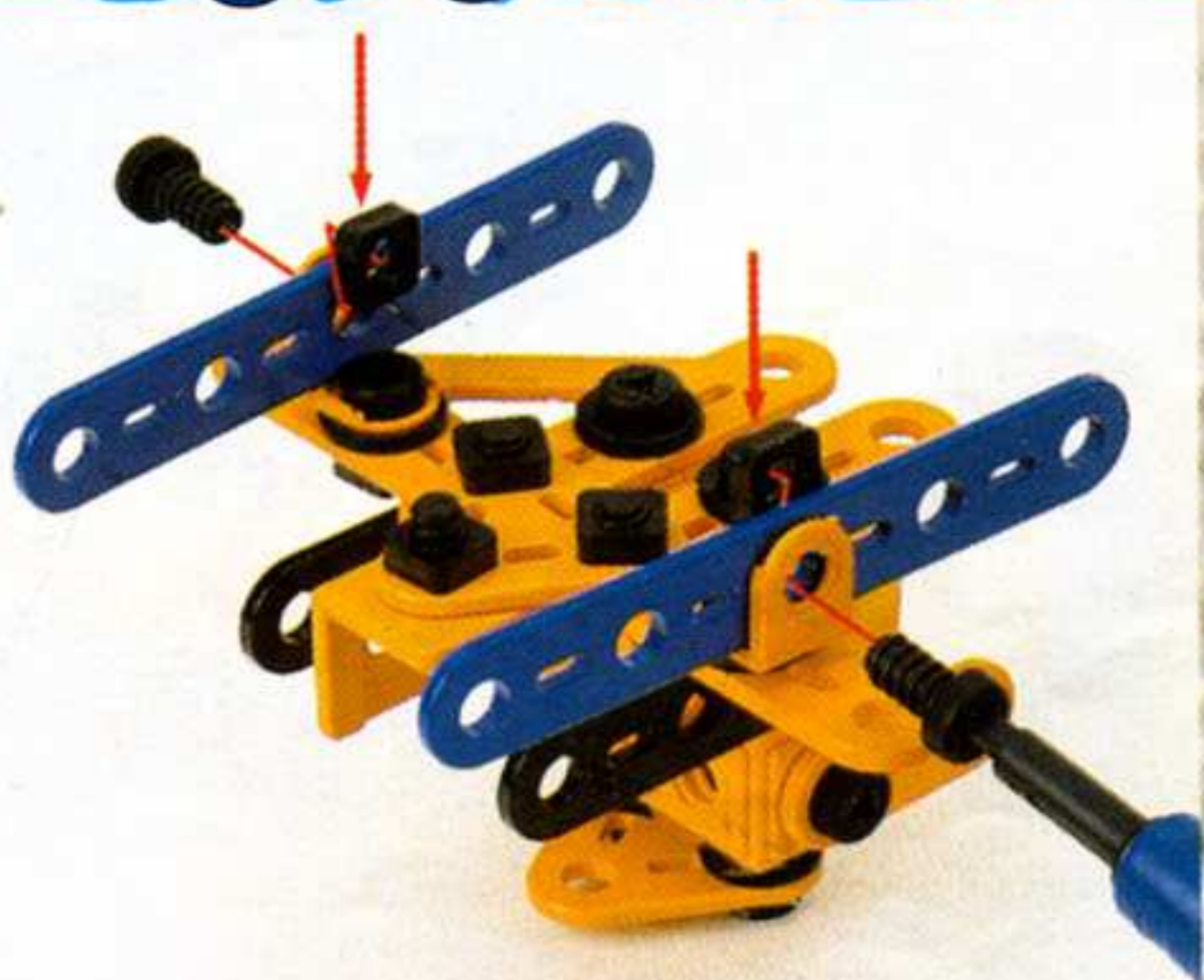

11



12

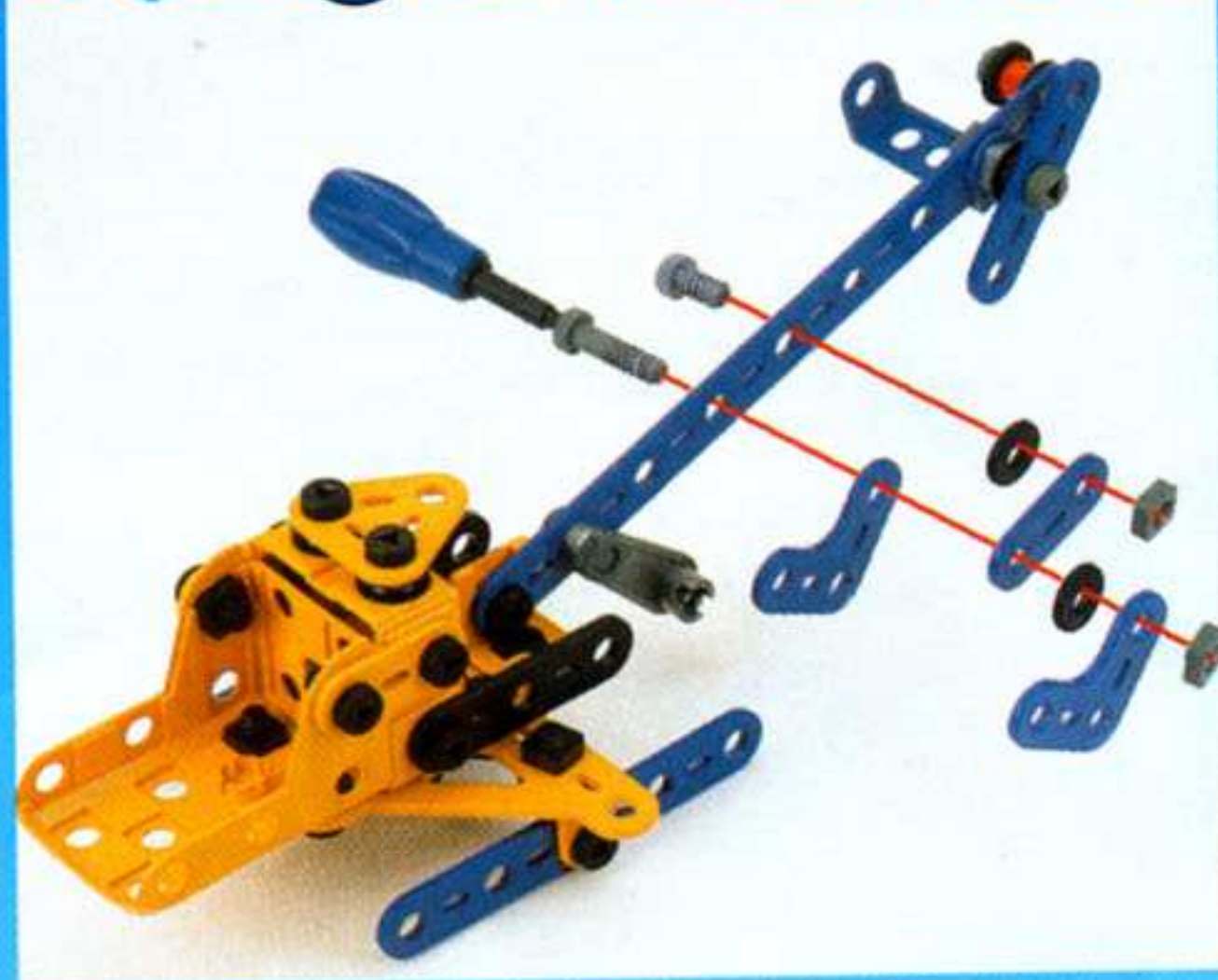

13



17



18



19



23



24



25

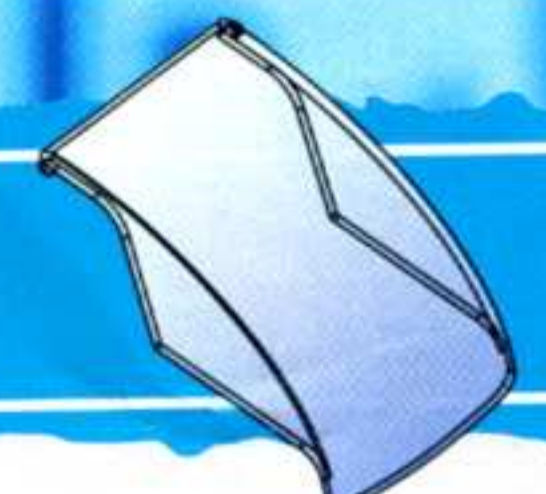

26

1

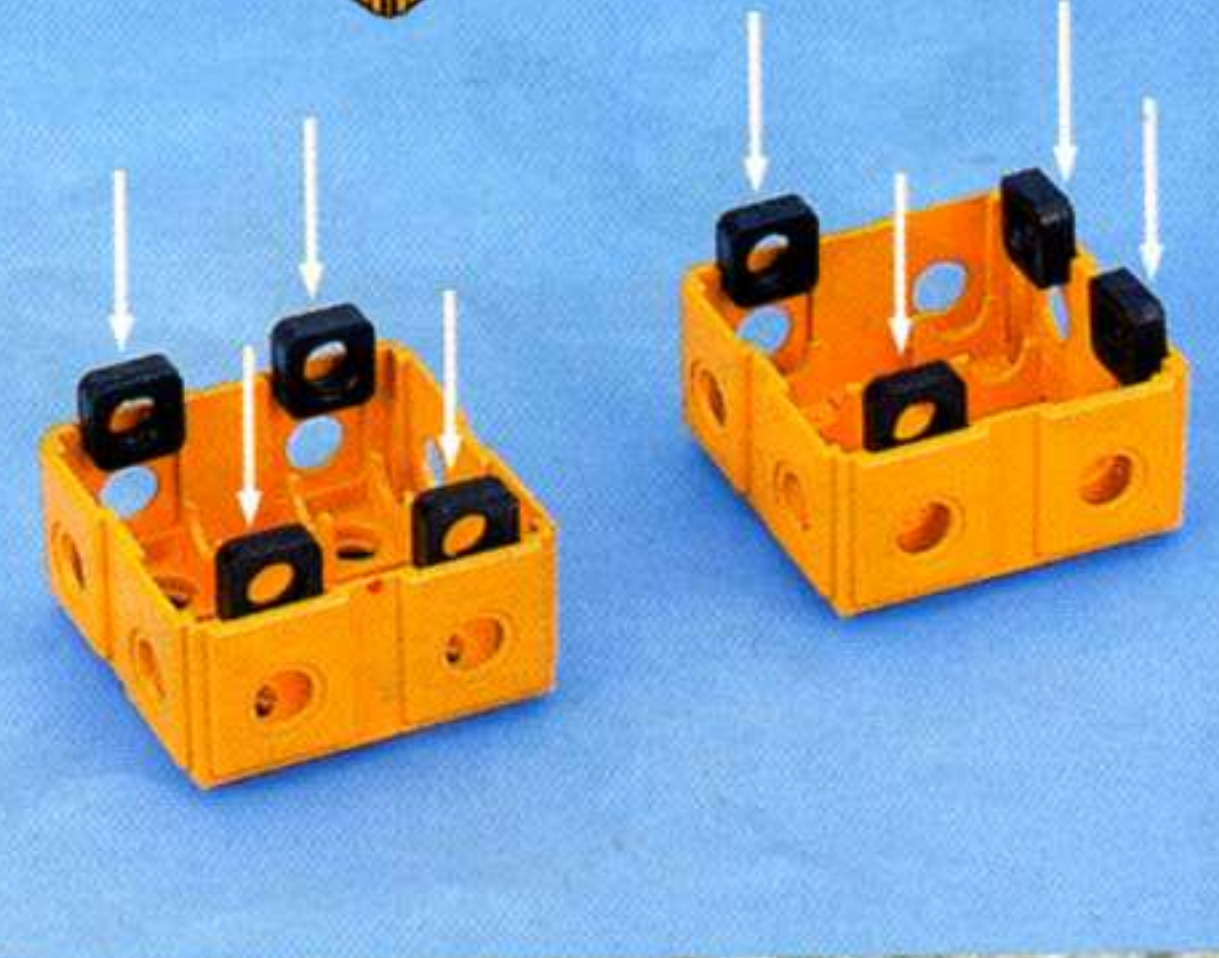
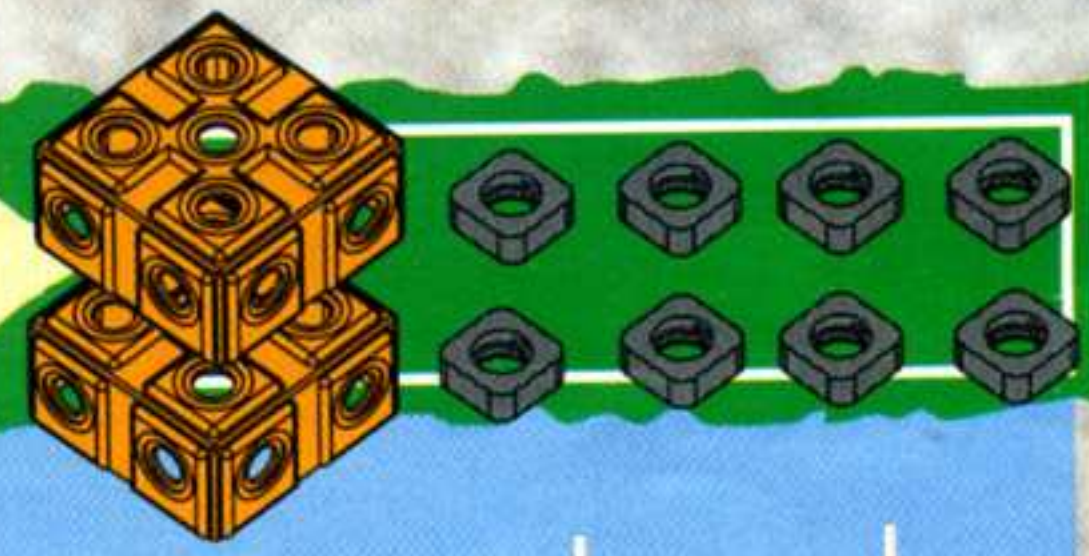

14



15



16



20



21



22



2



3



4

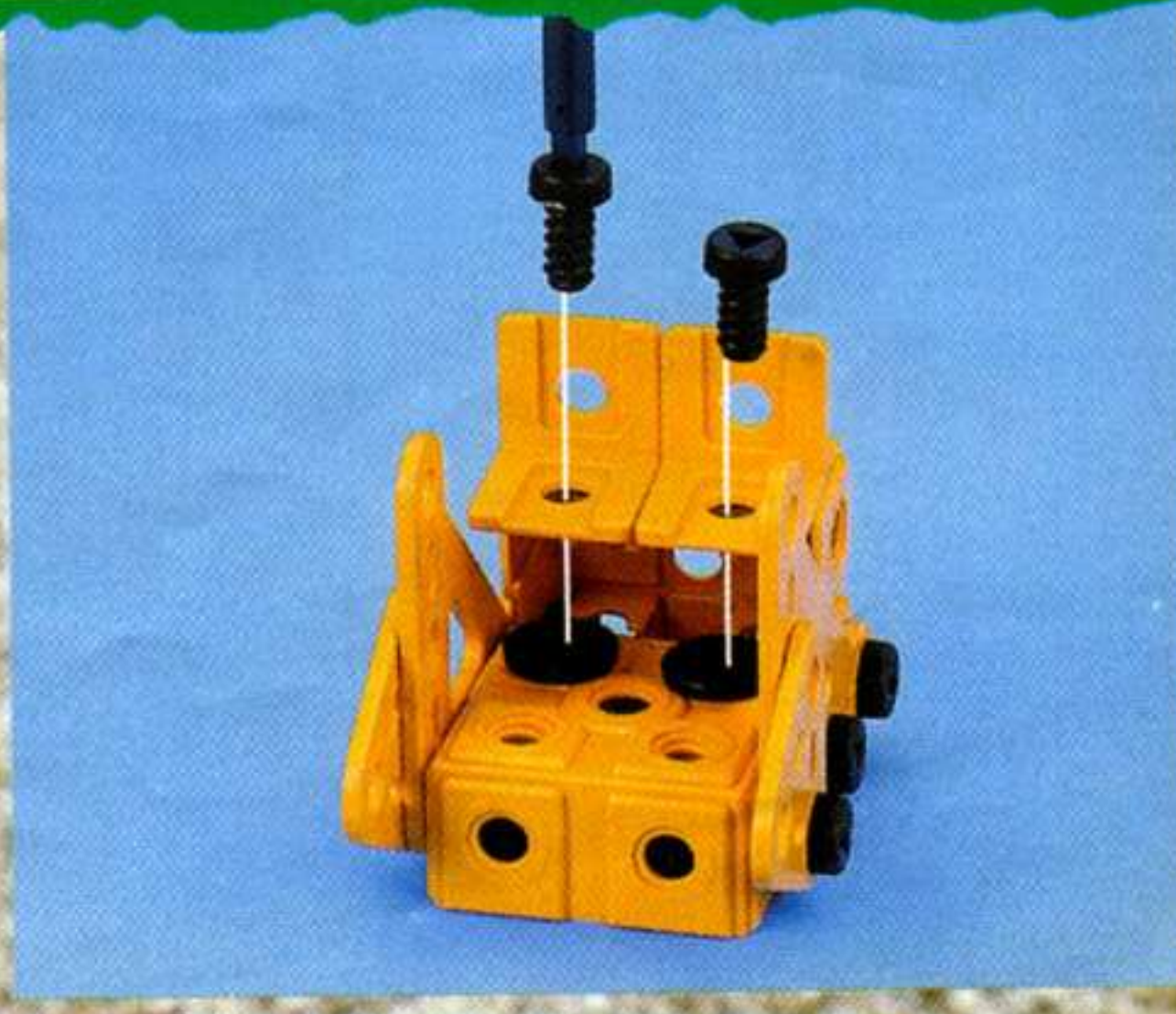
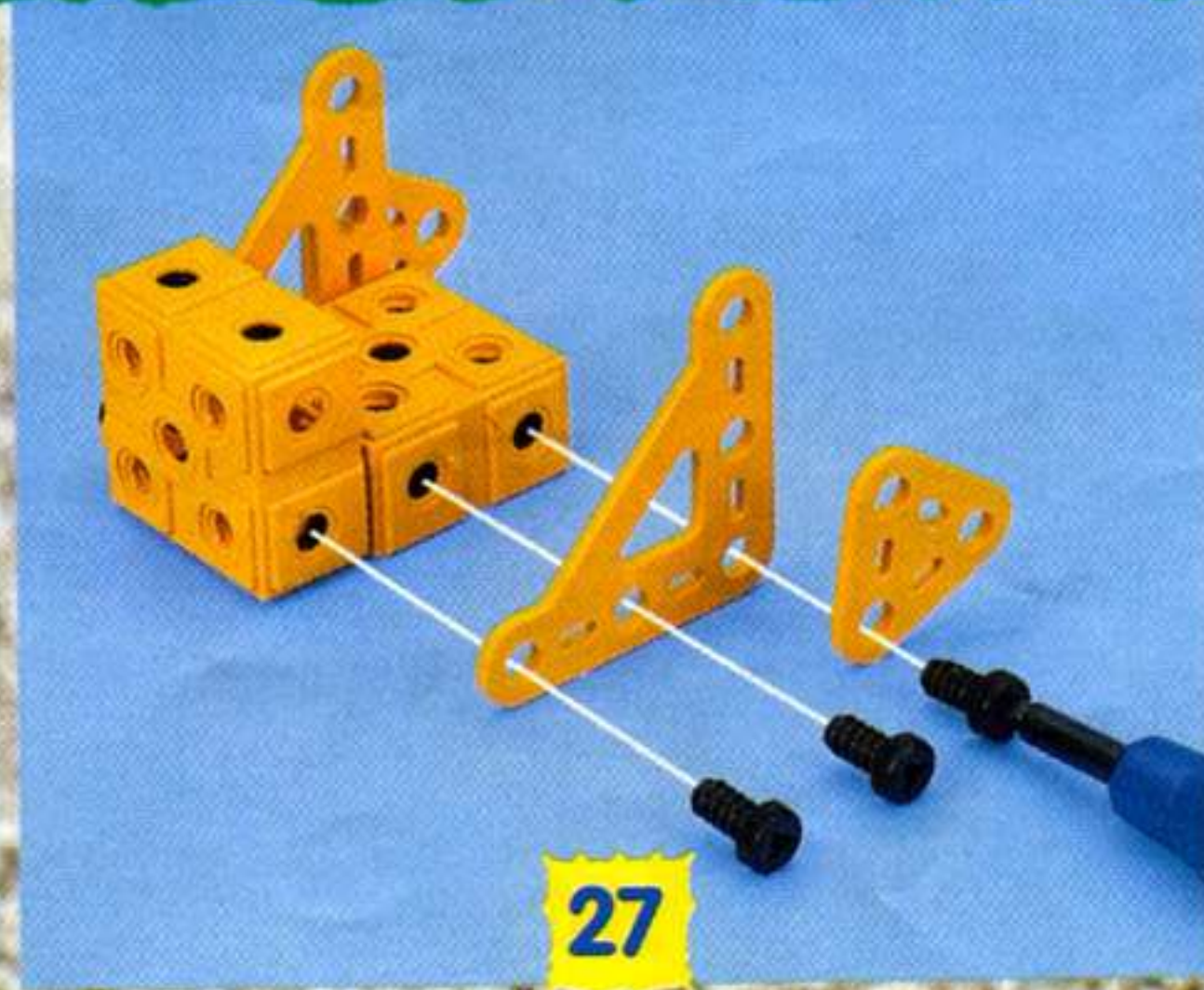
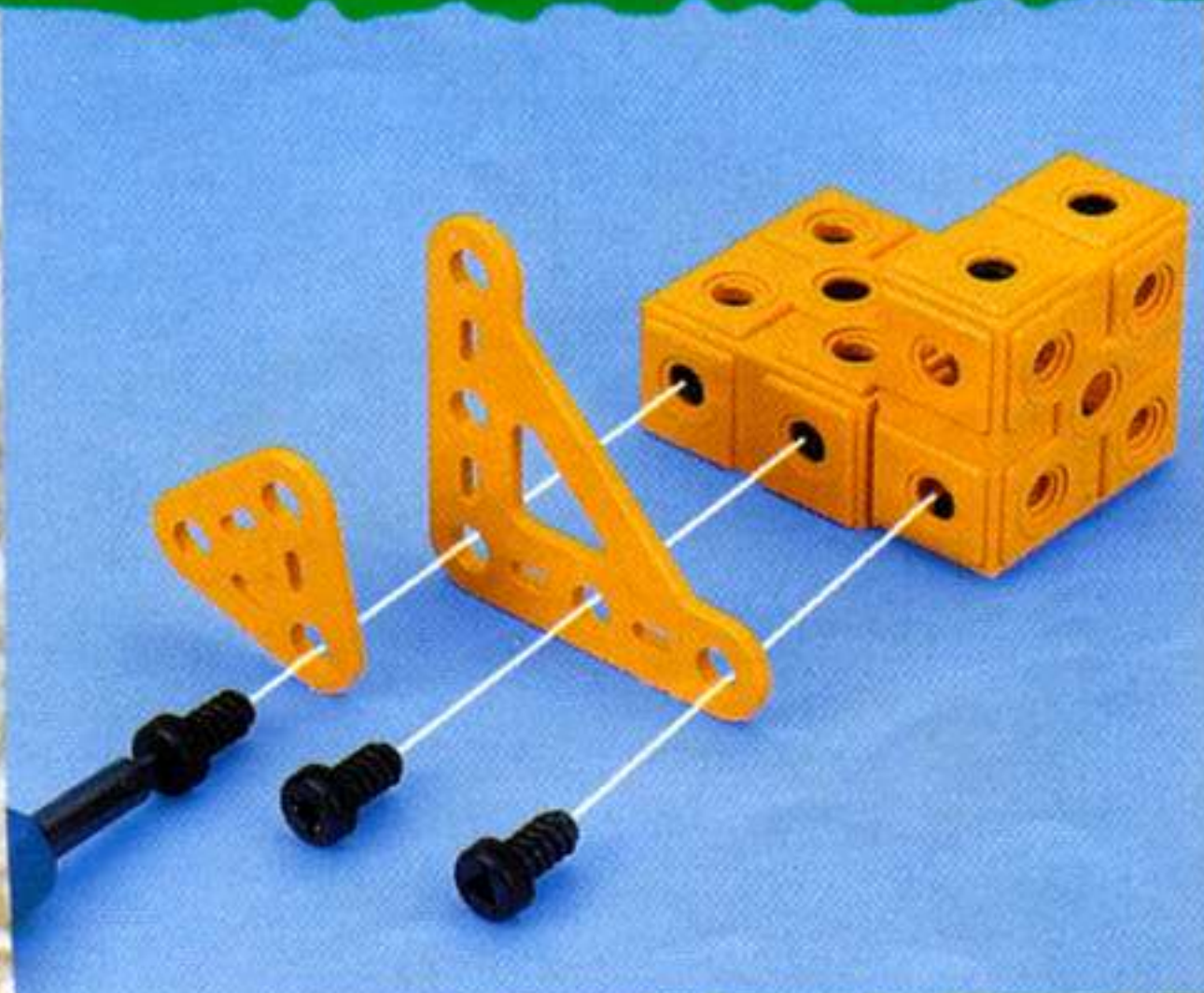

27

5

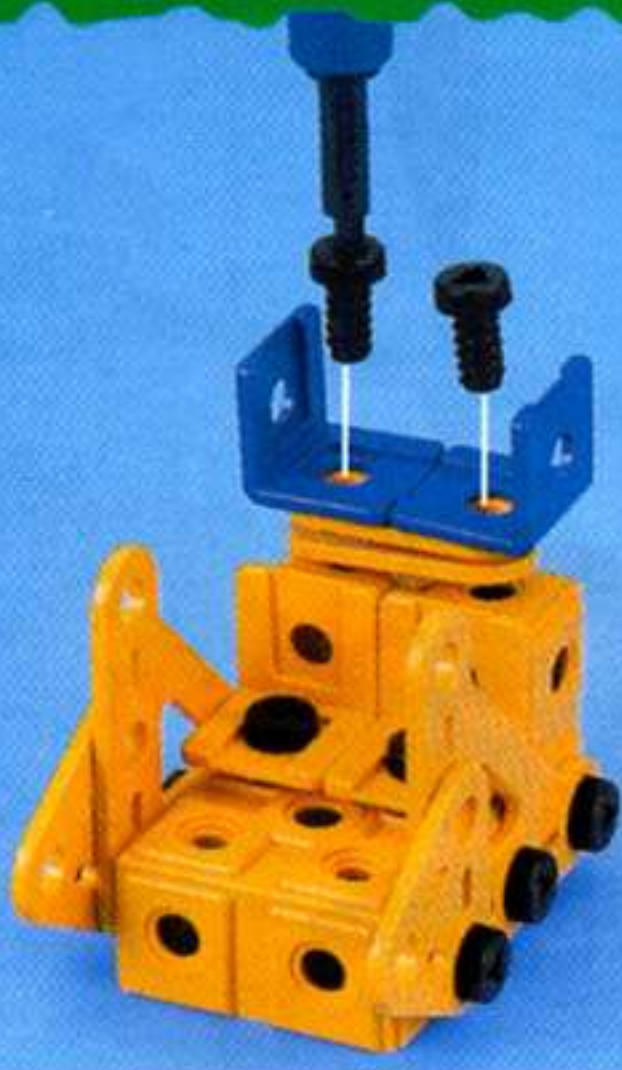

6

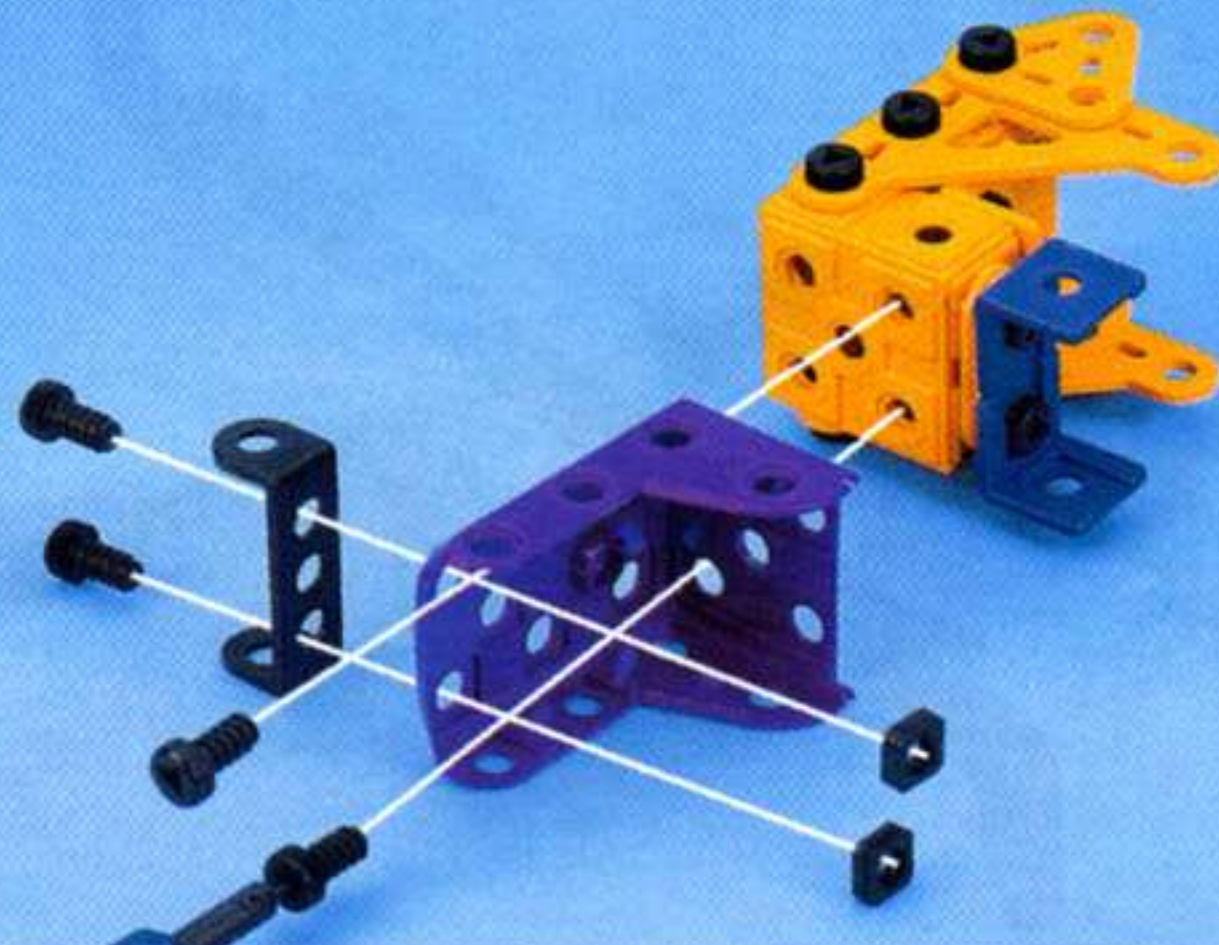
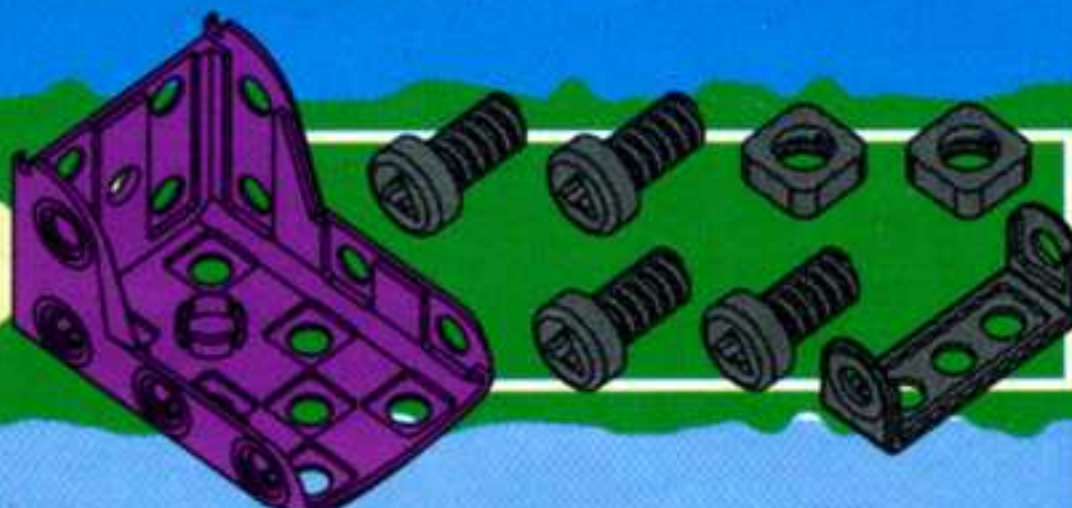

7

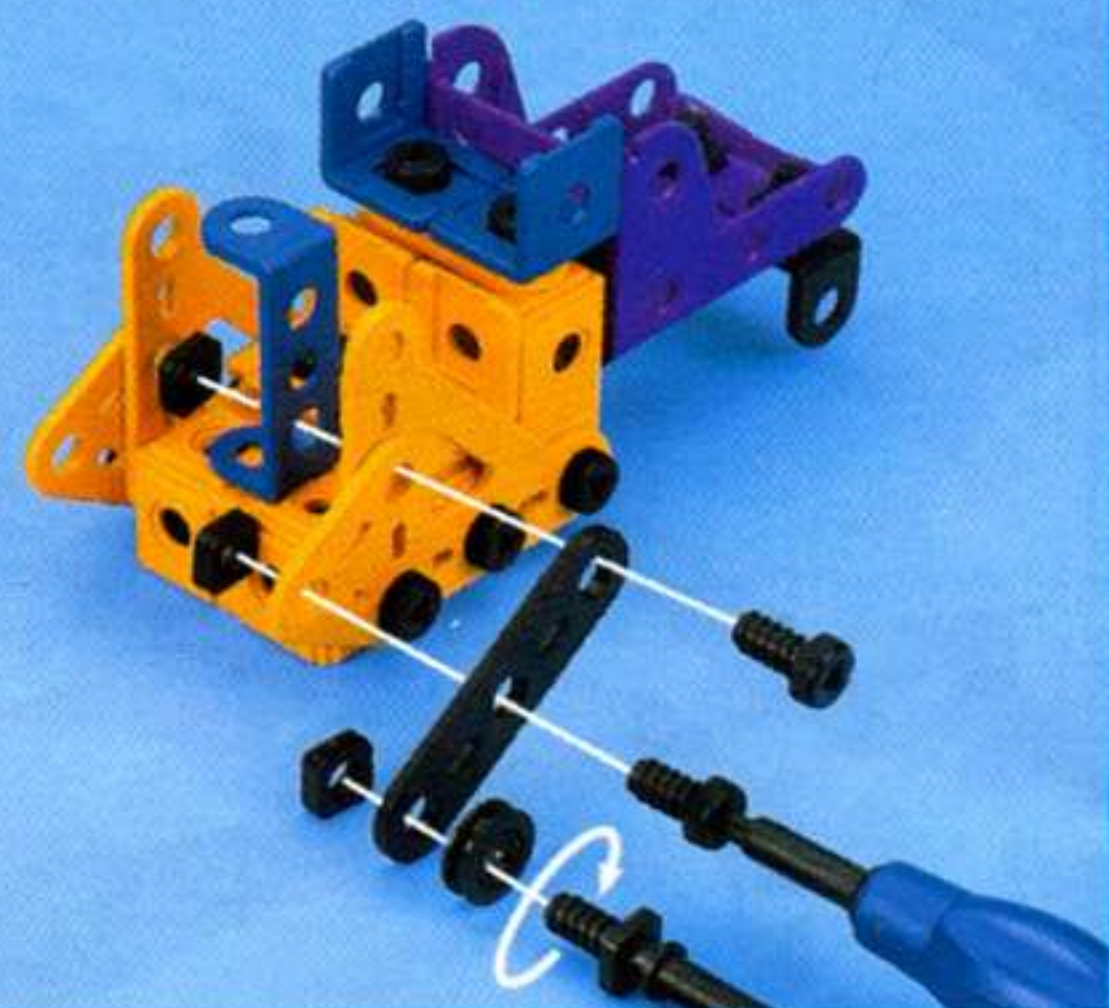

11



12

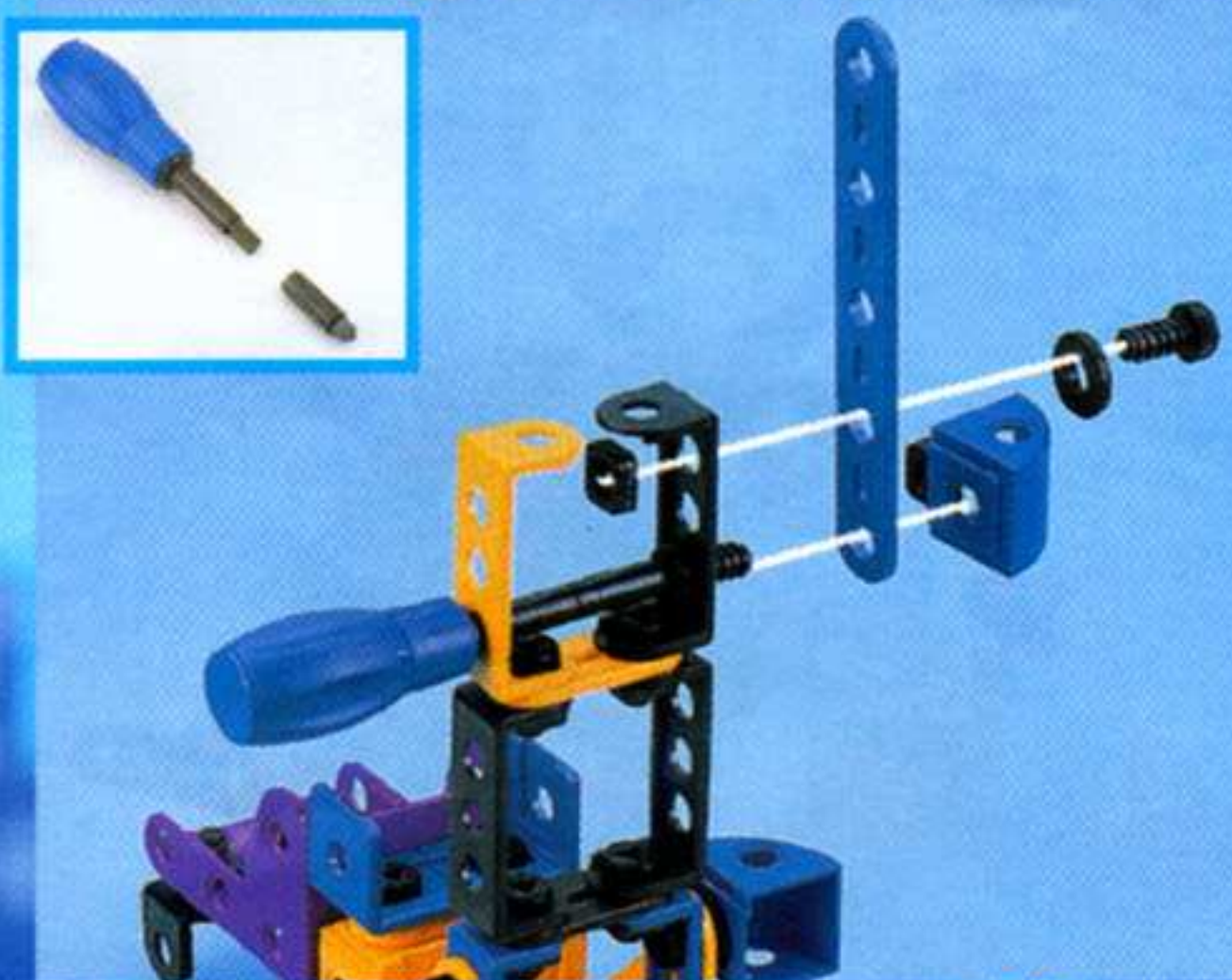

13

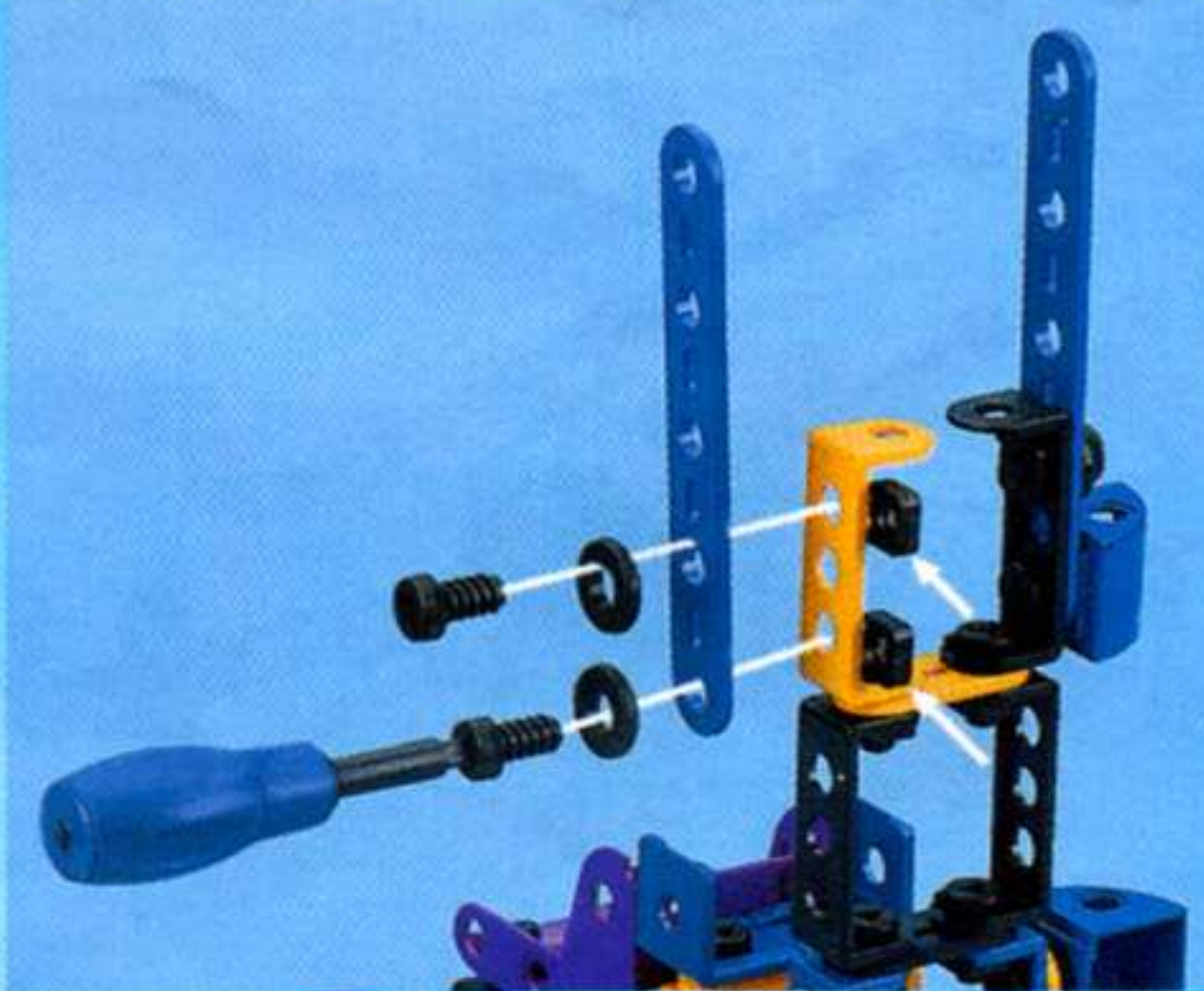

17

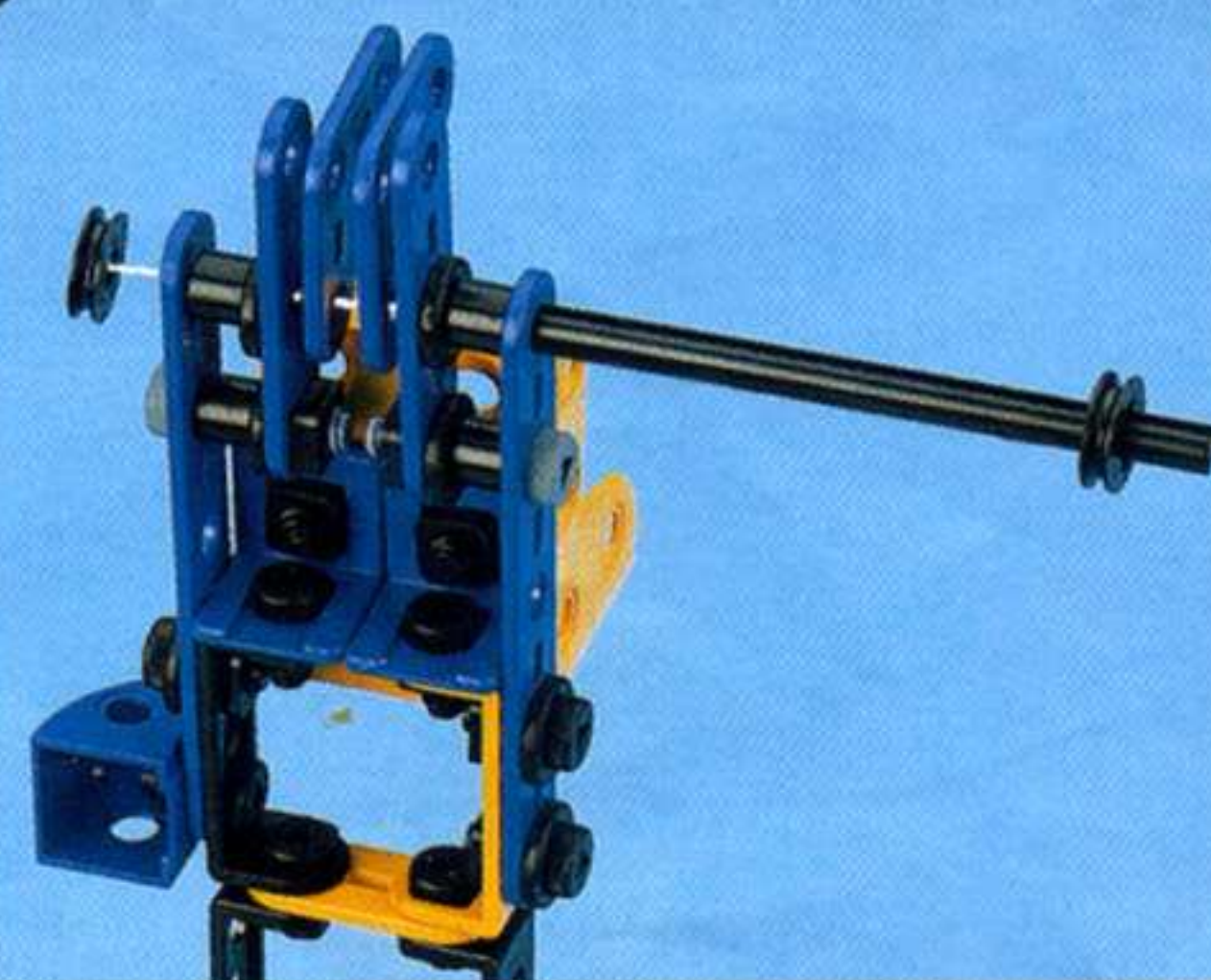

18

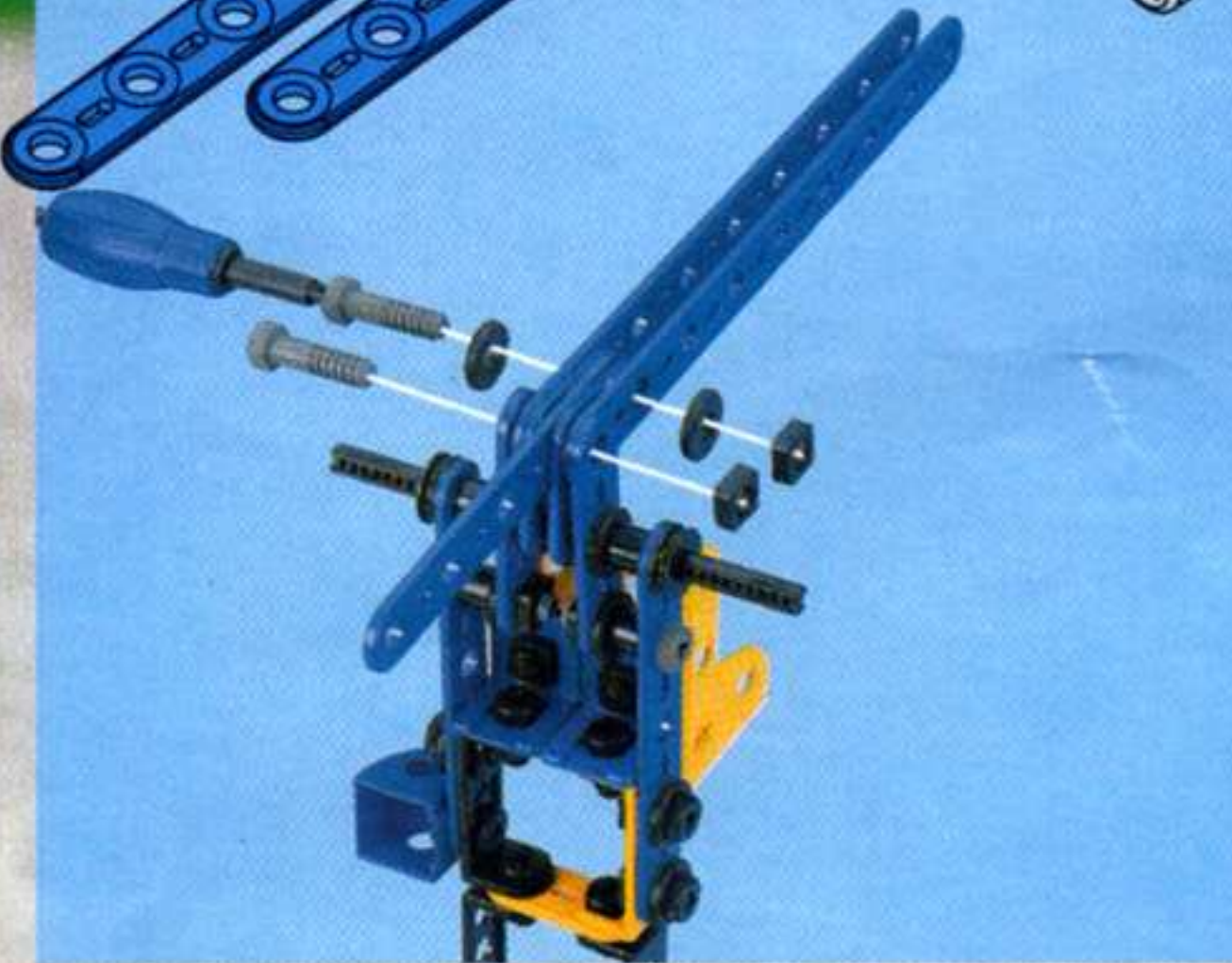

19

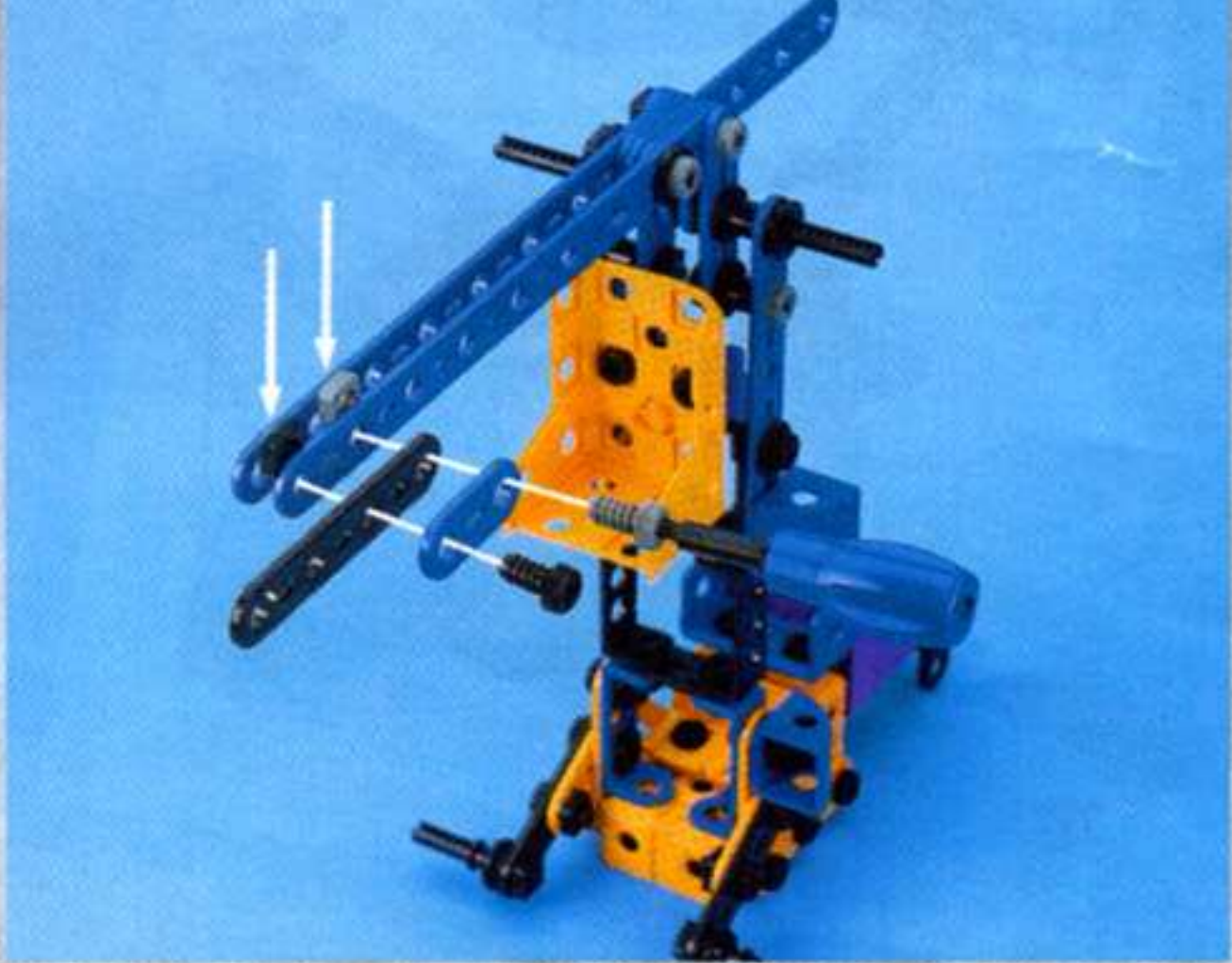

23

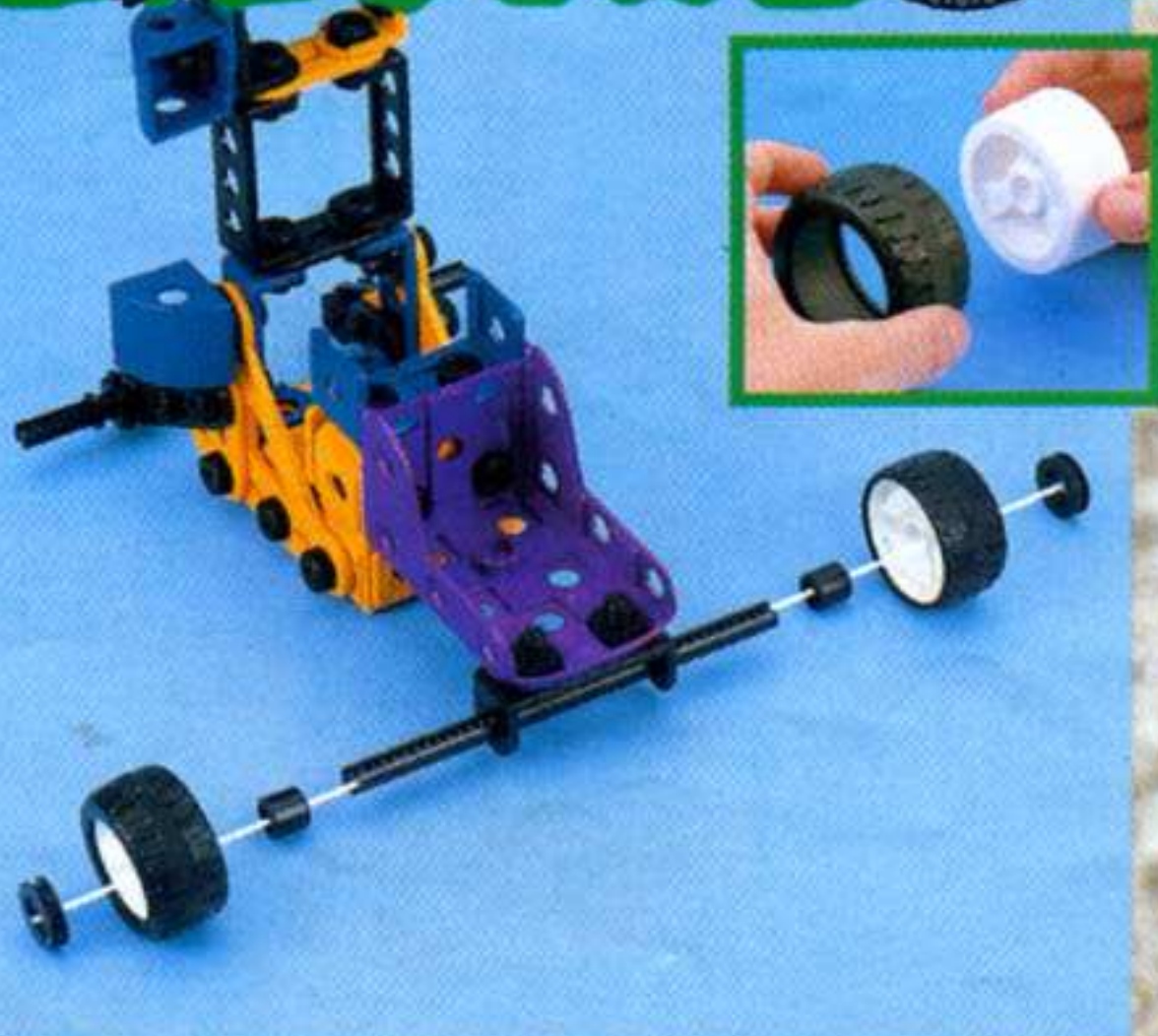
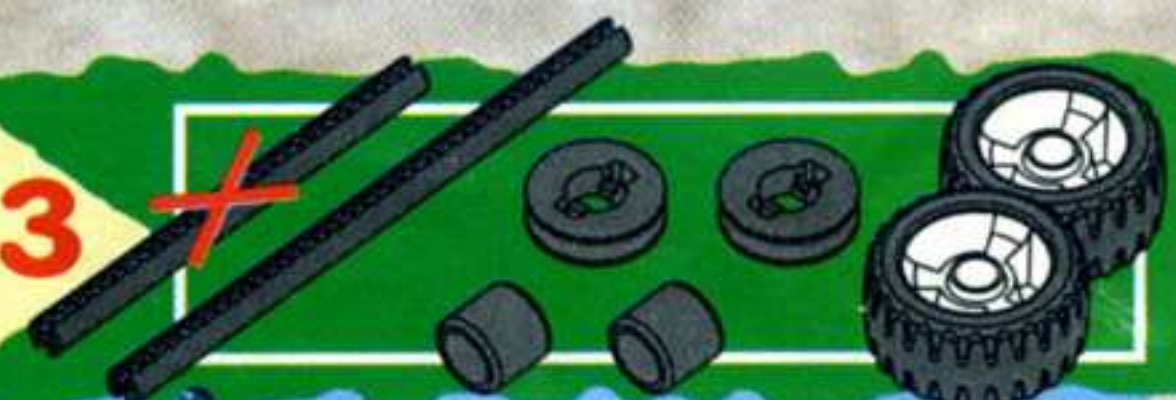

24

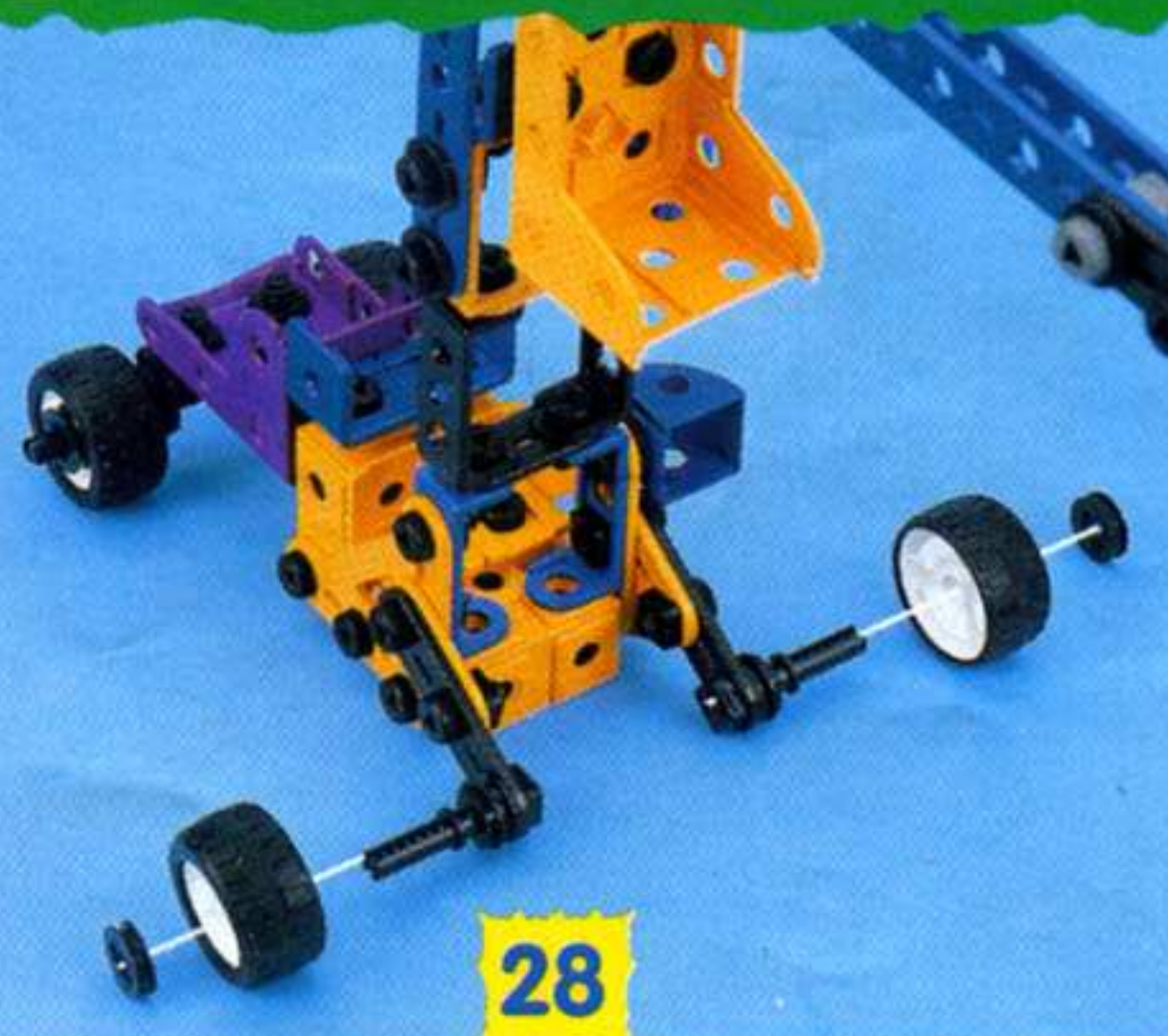

25



8

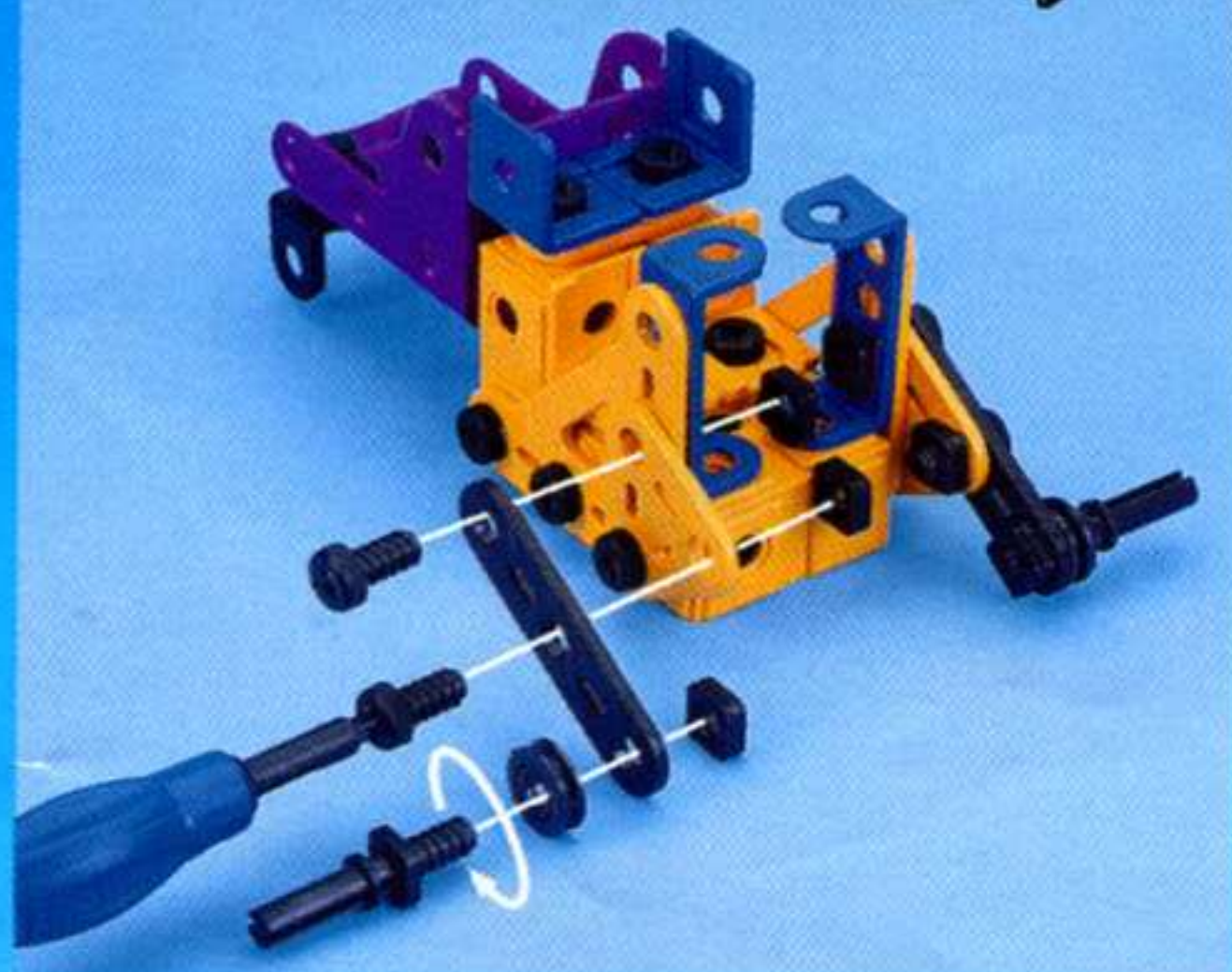

9

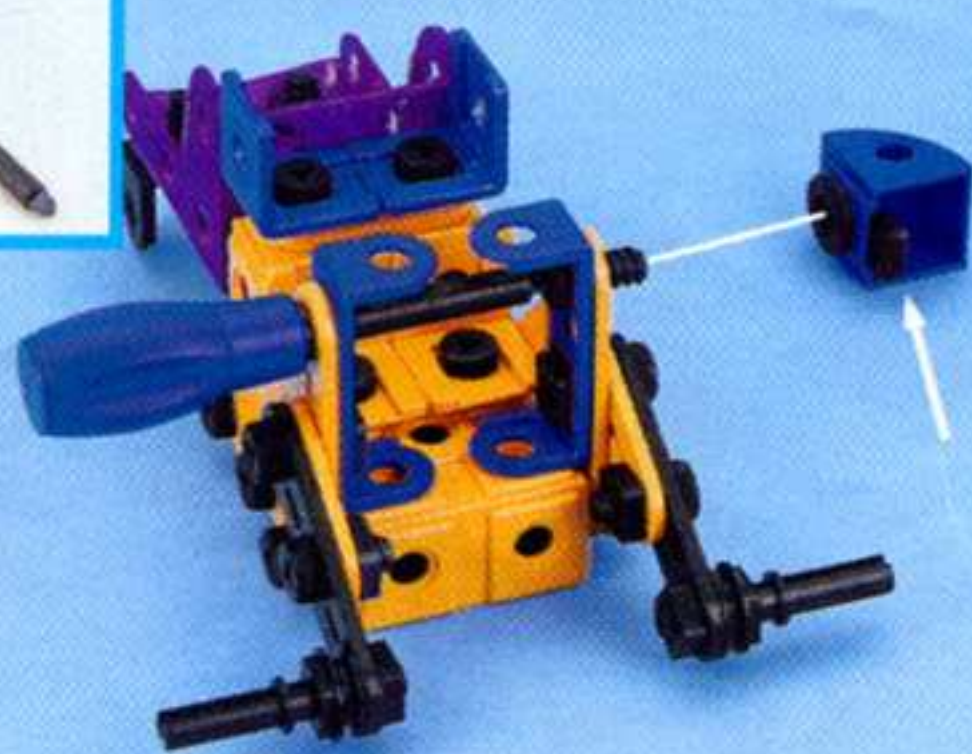

10

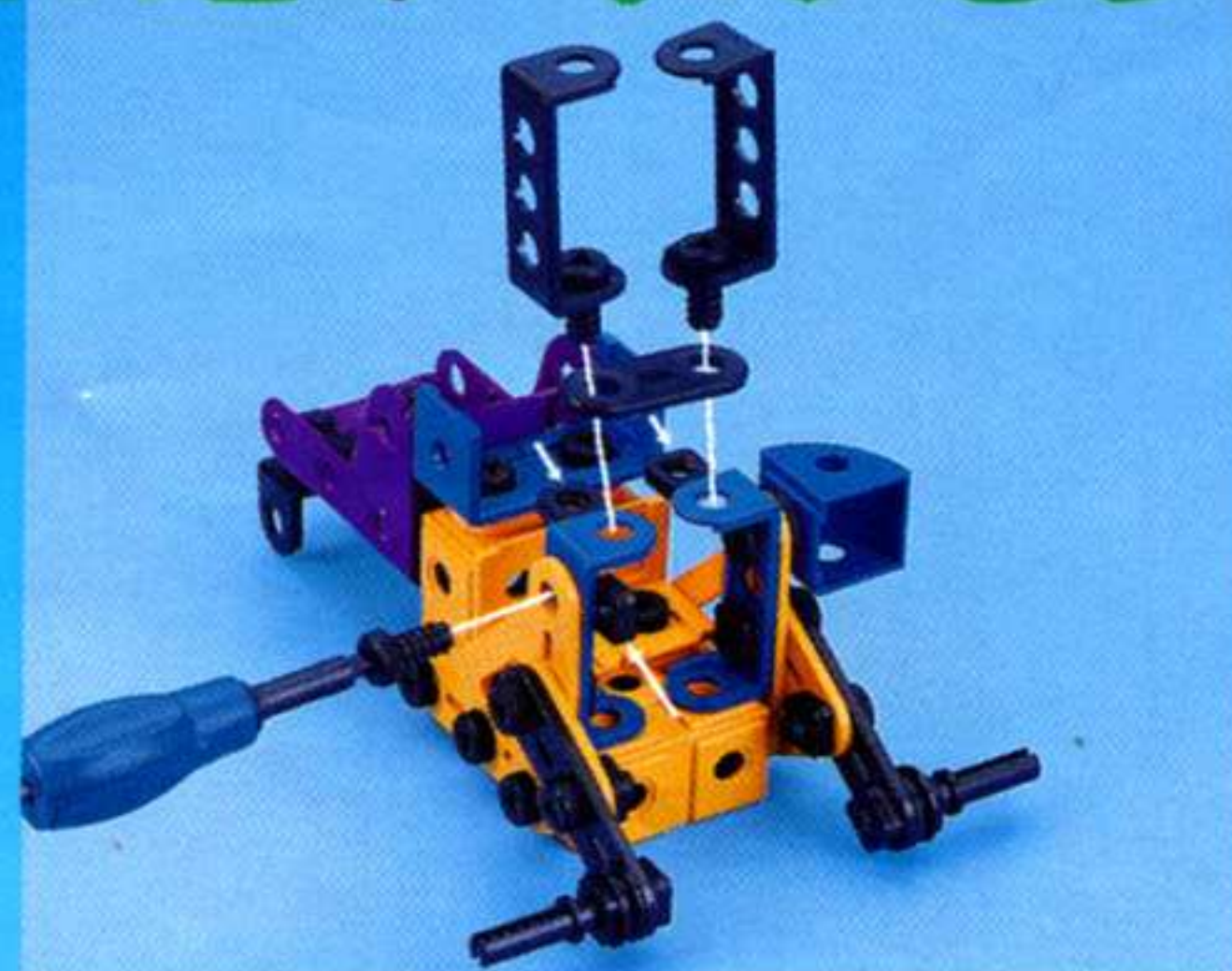

14



15

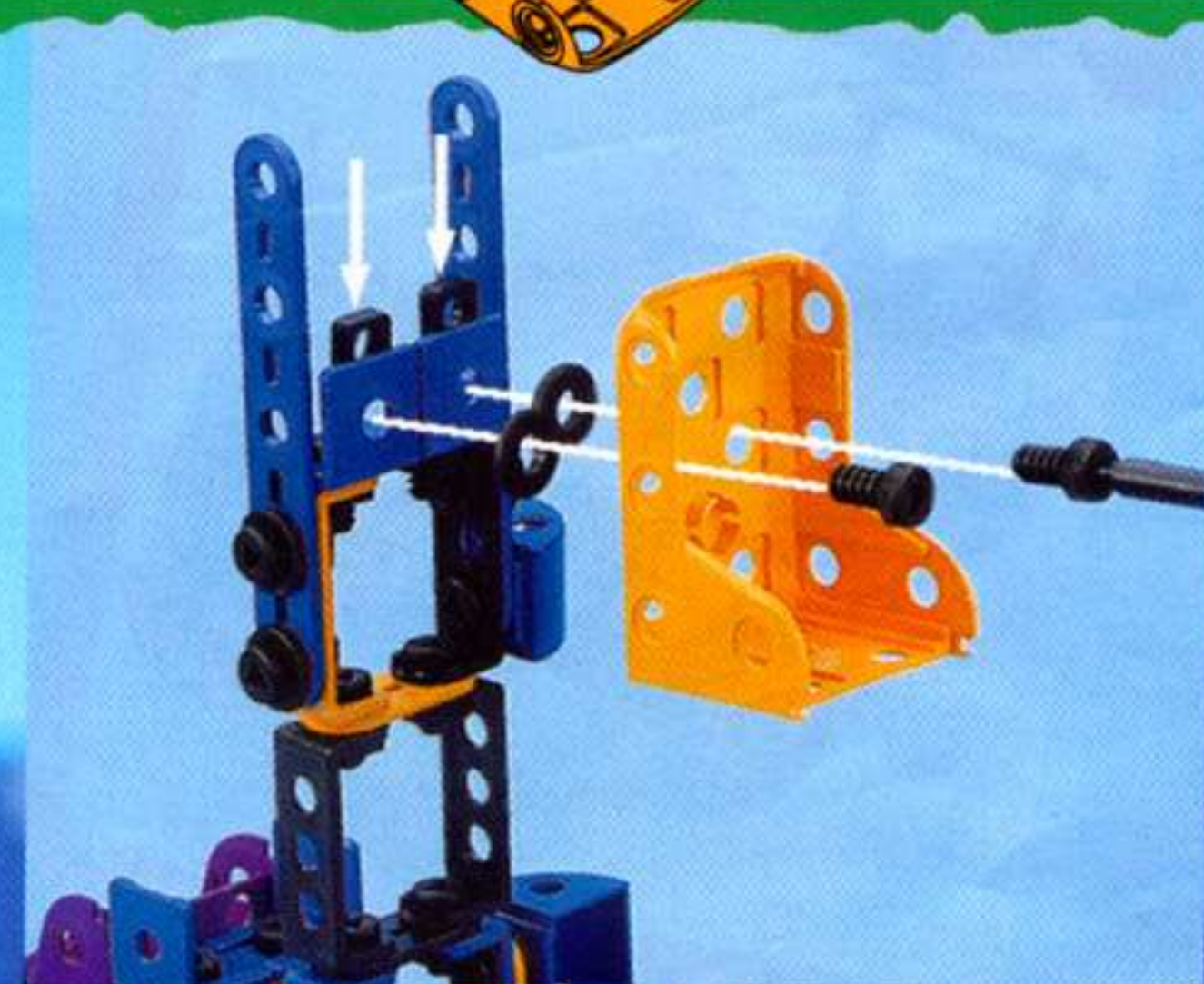

16

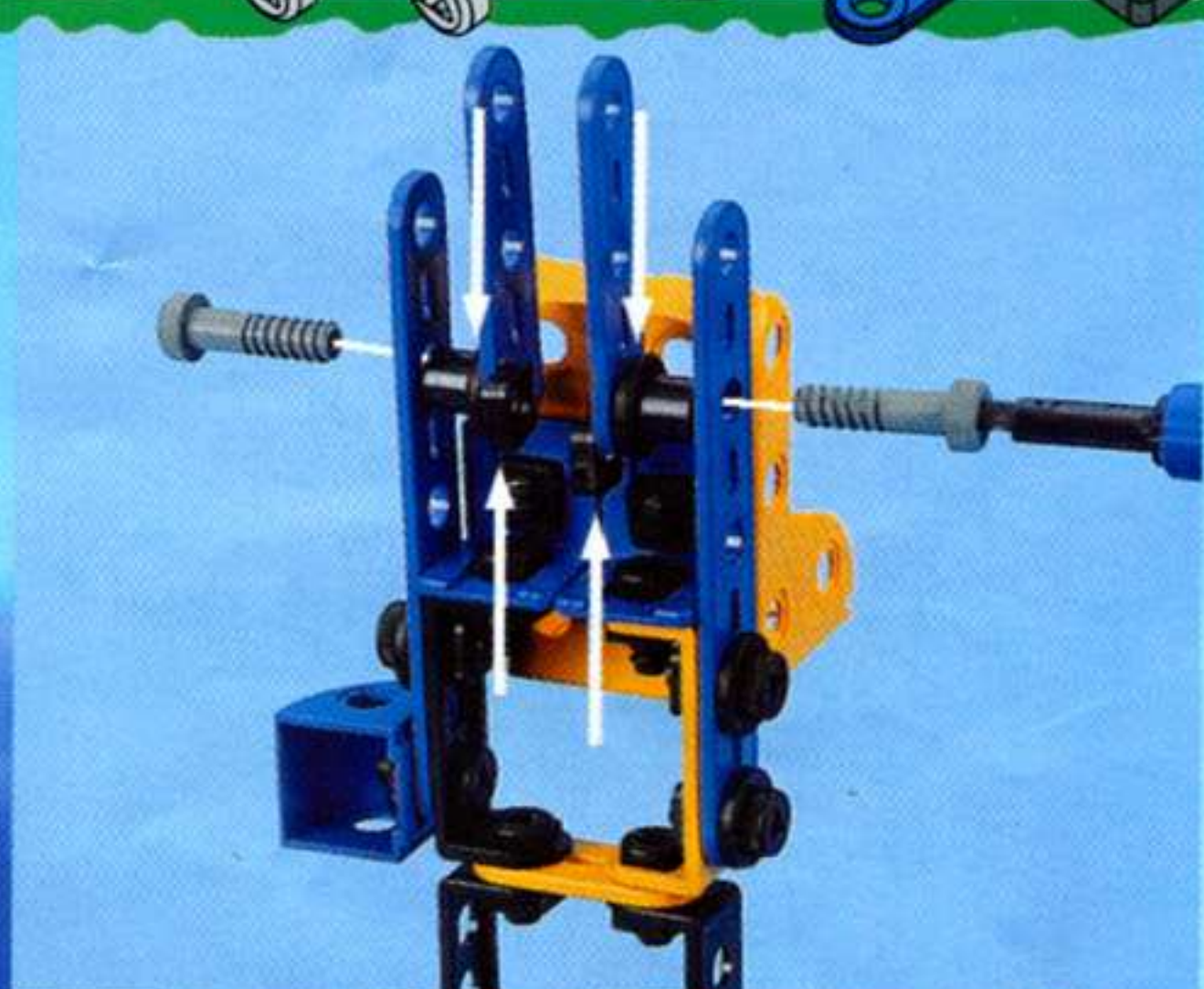

20



21

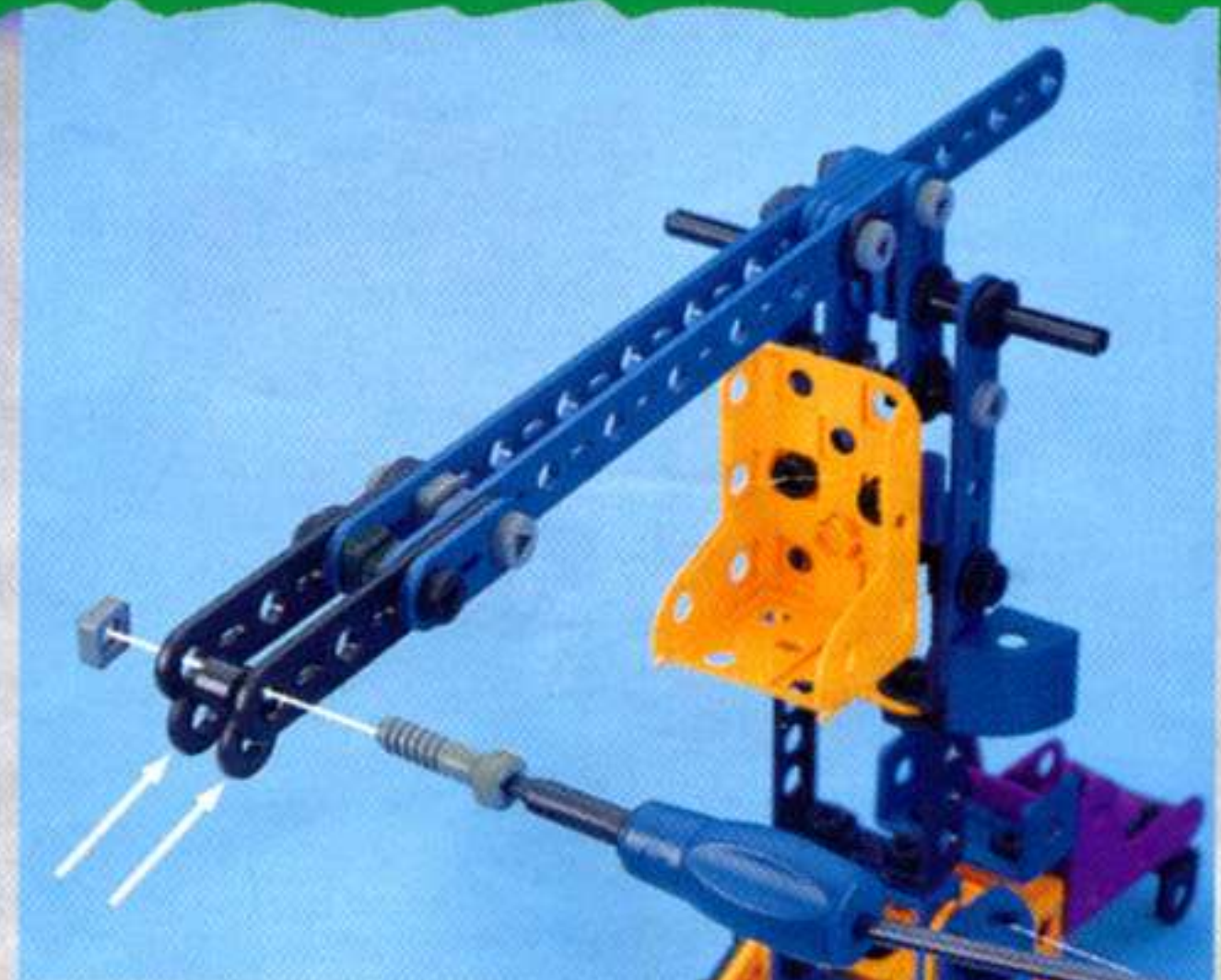
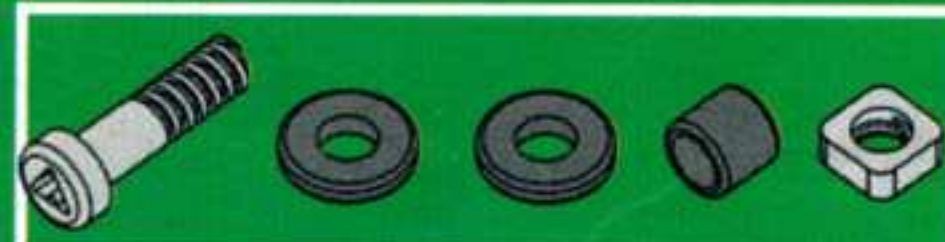

22



26

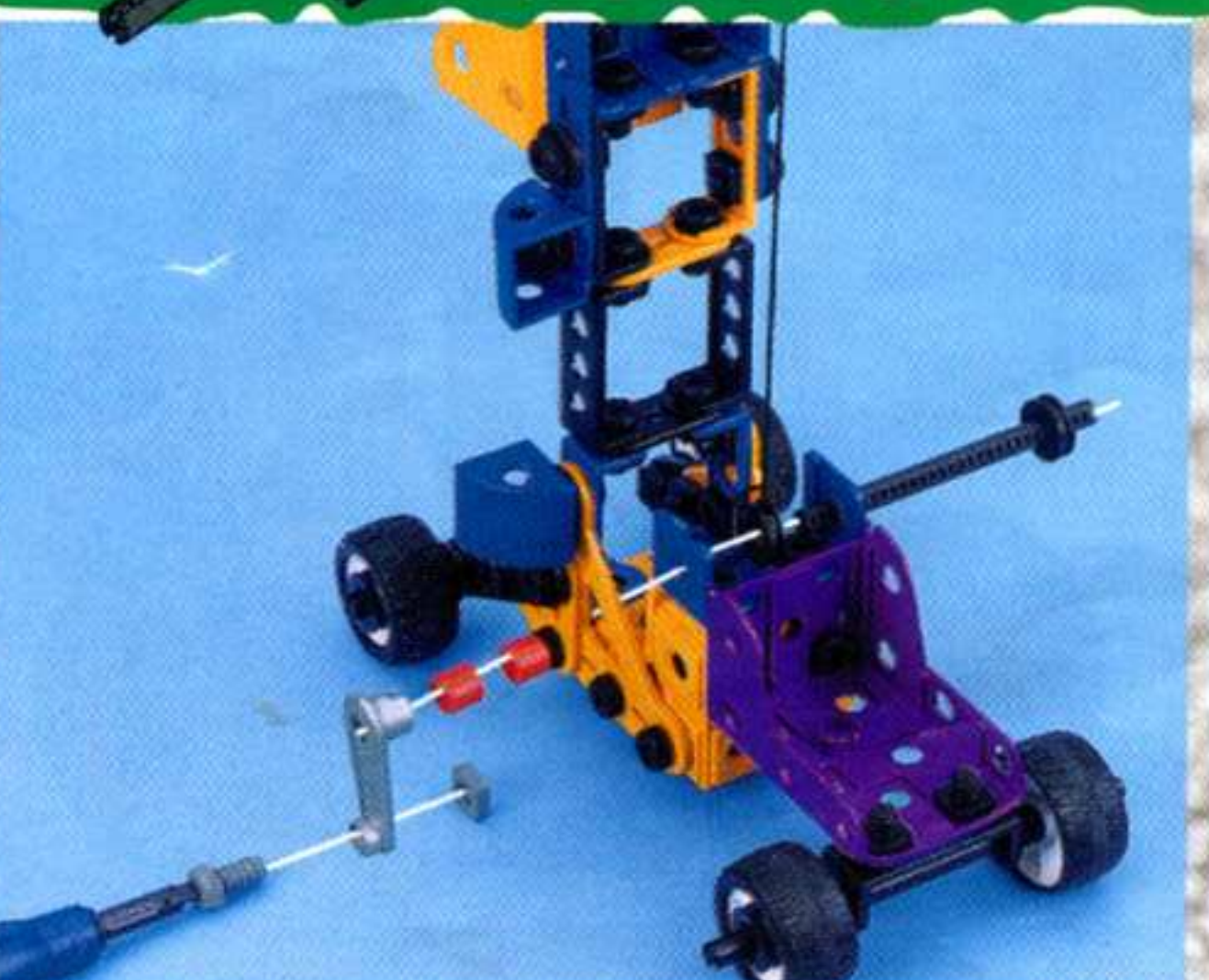

27



28

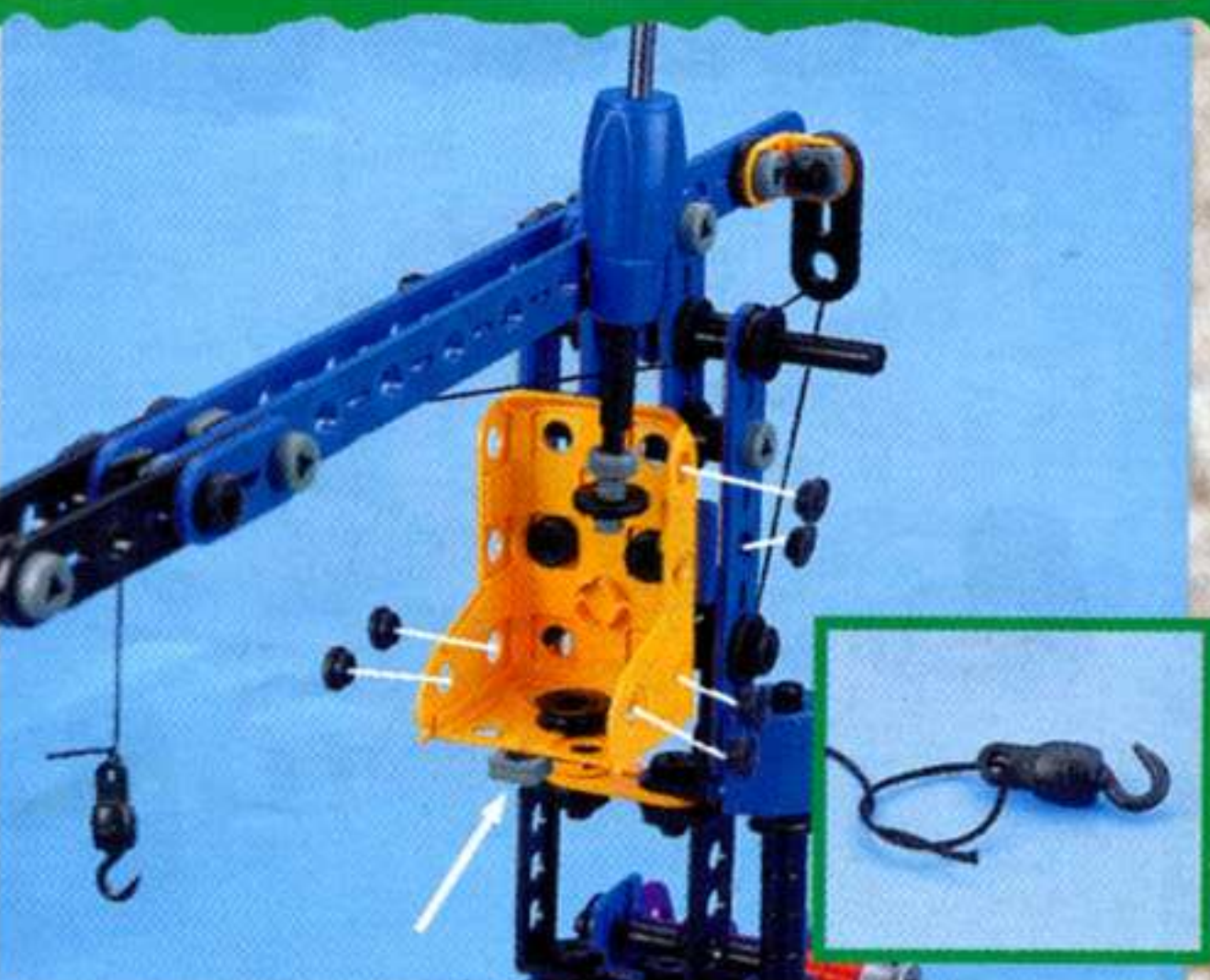
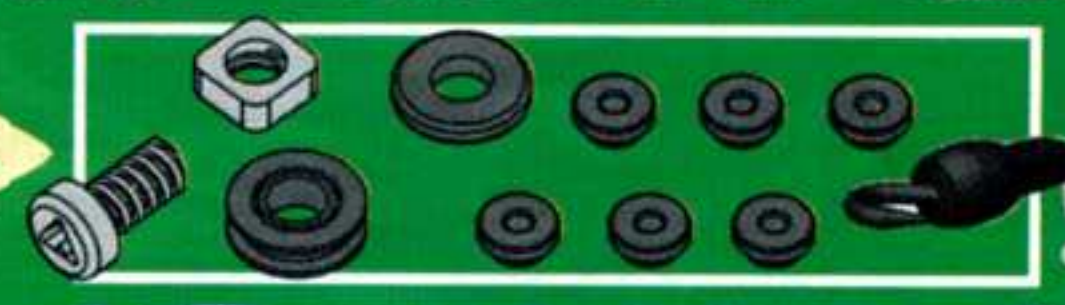

29

29



30

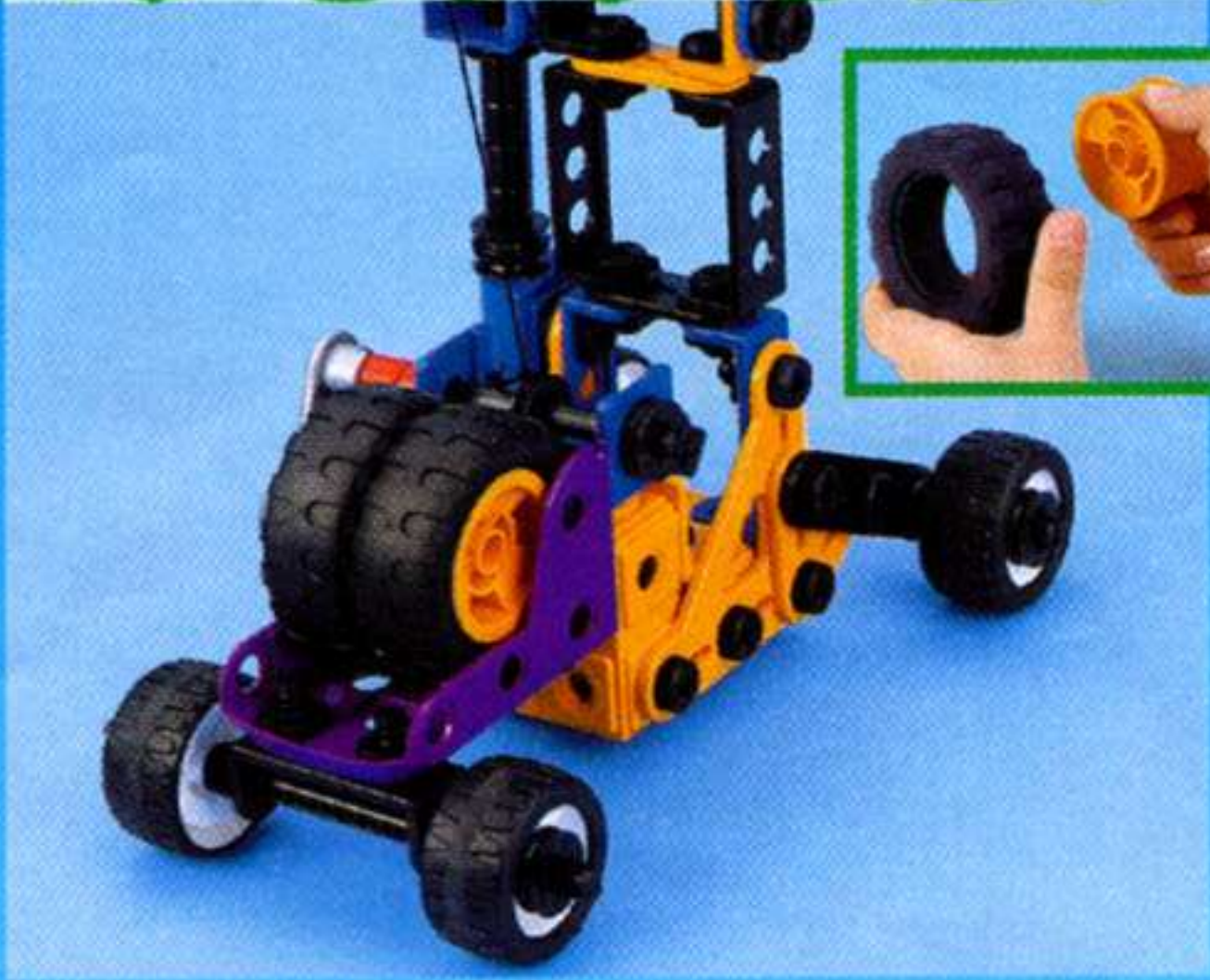
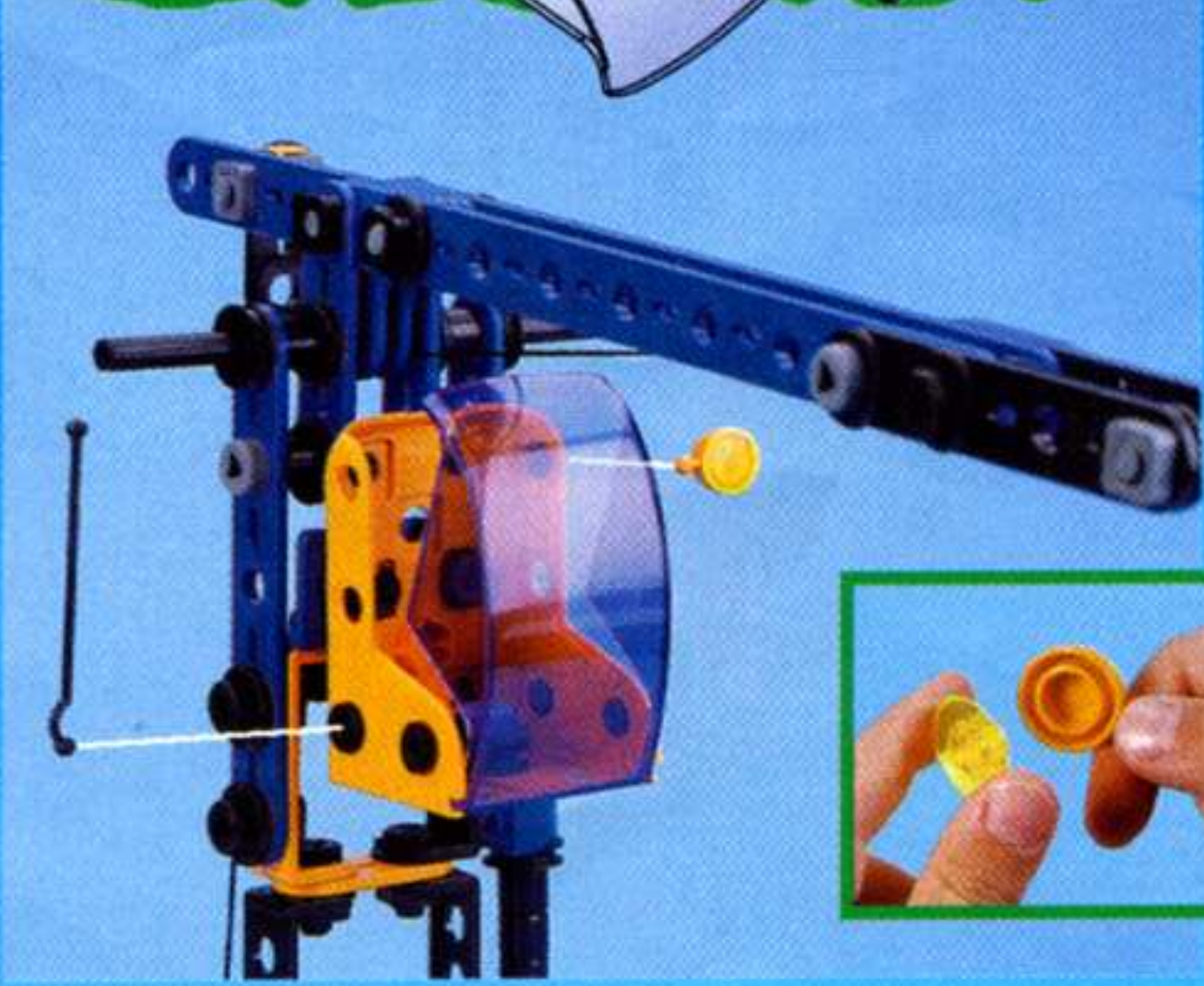

5



6



7

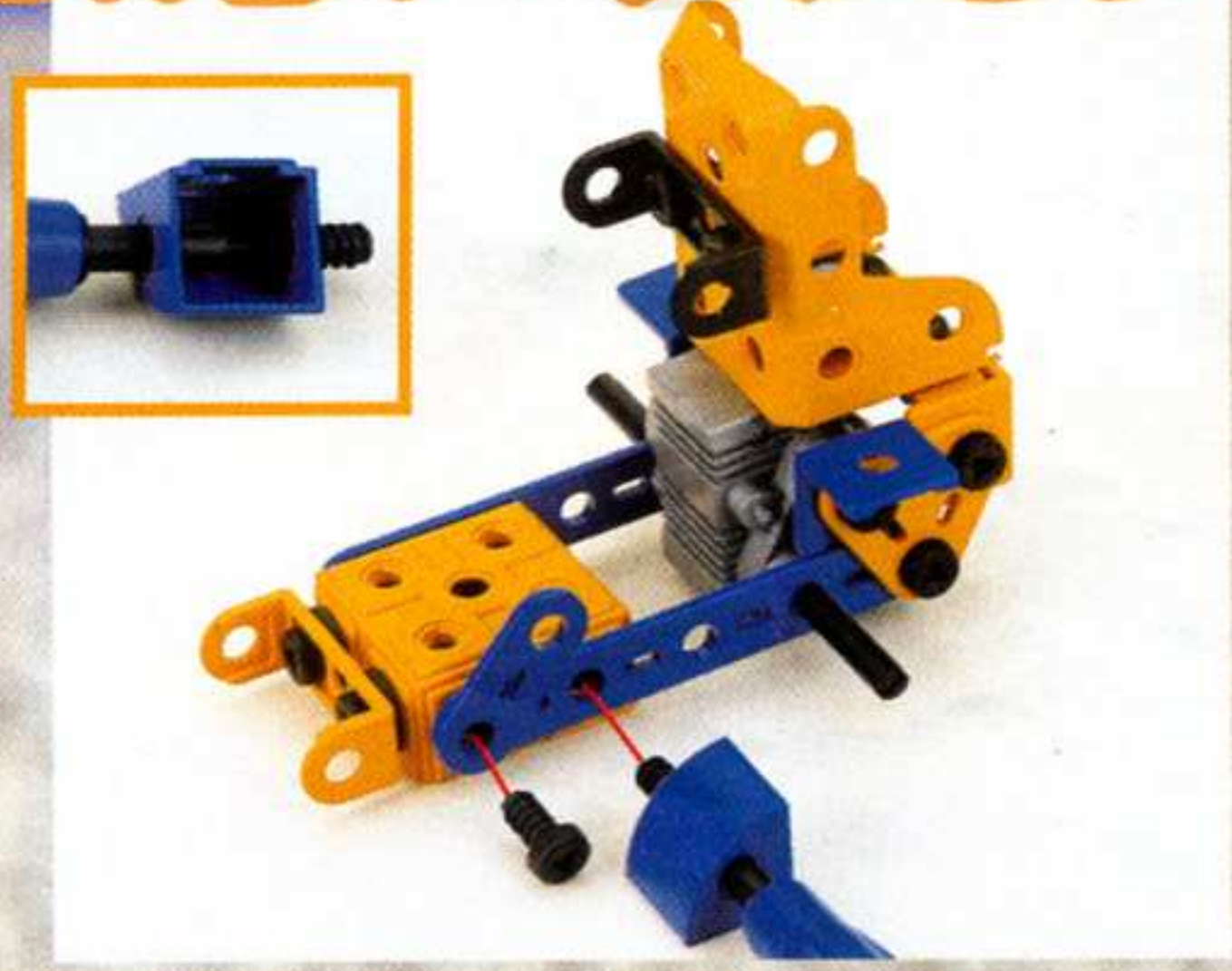
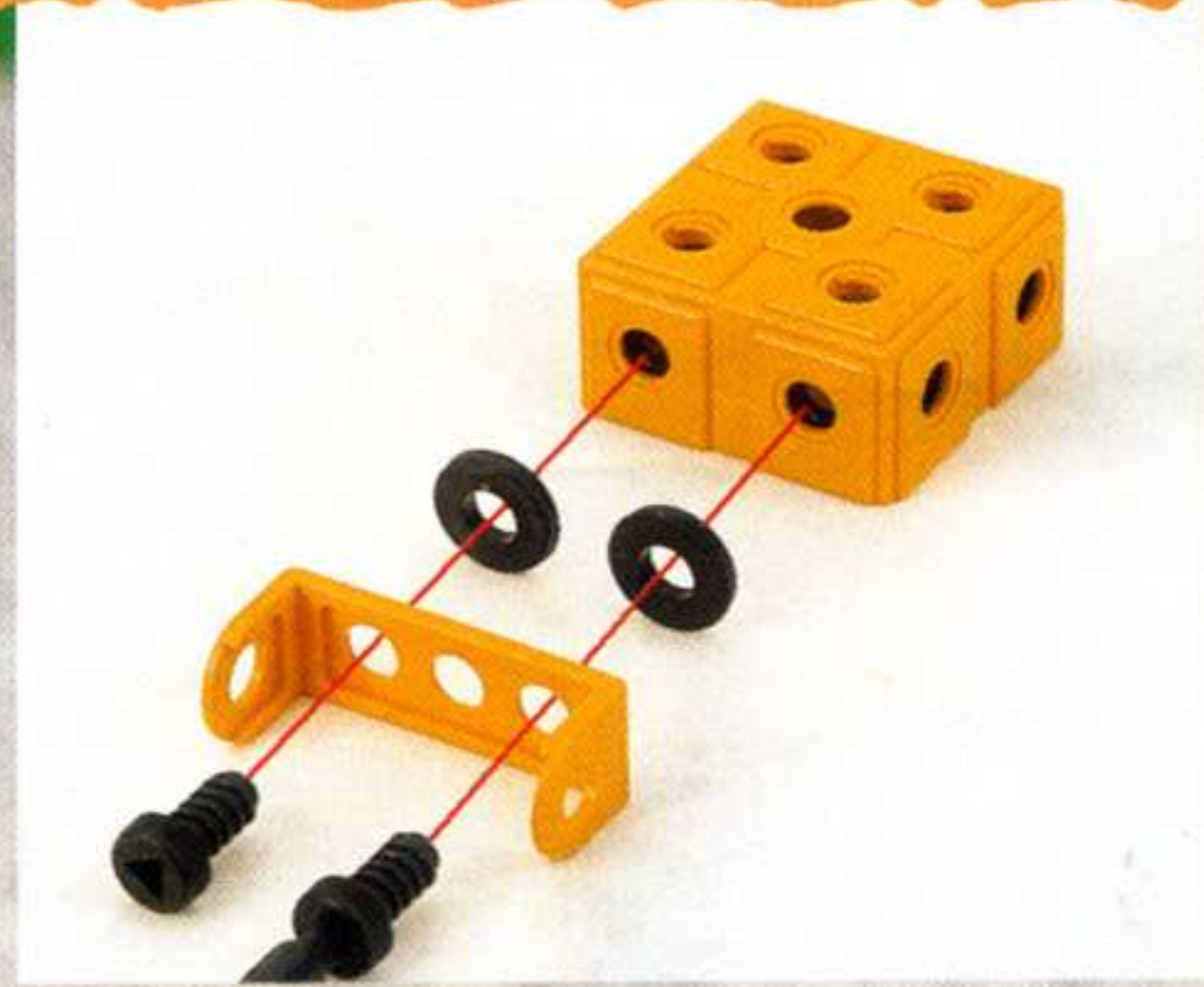

11



12



13

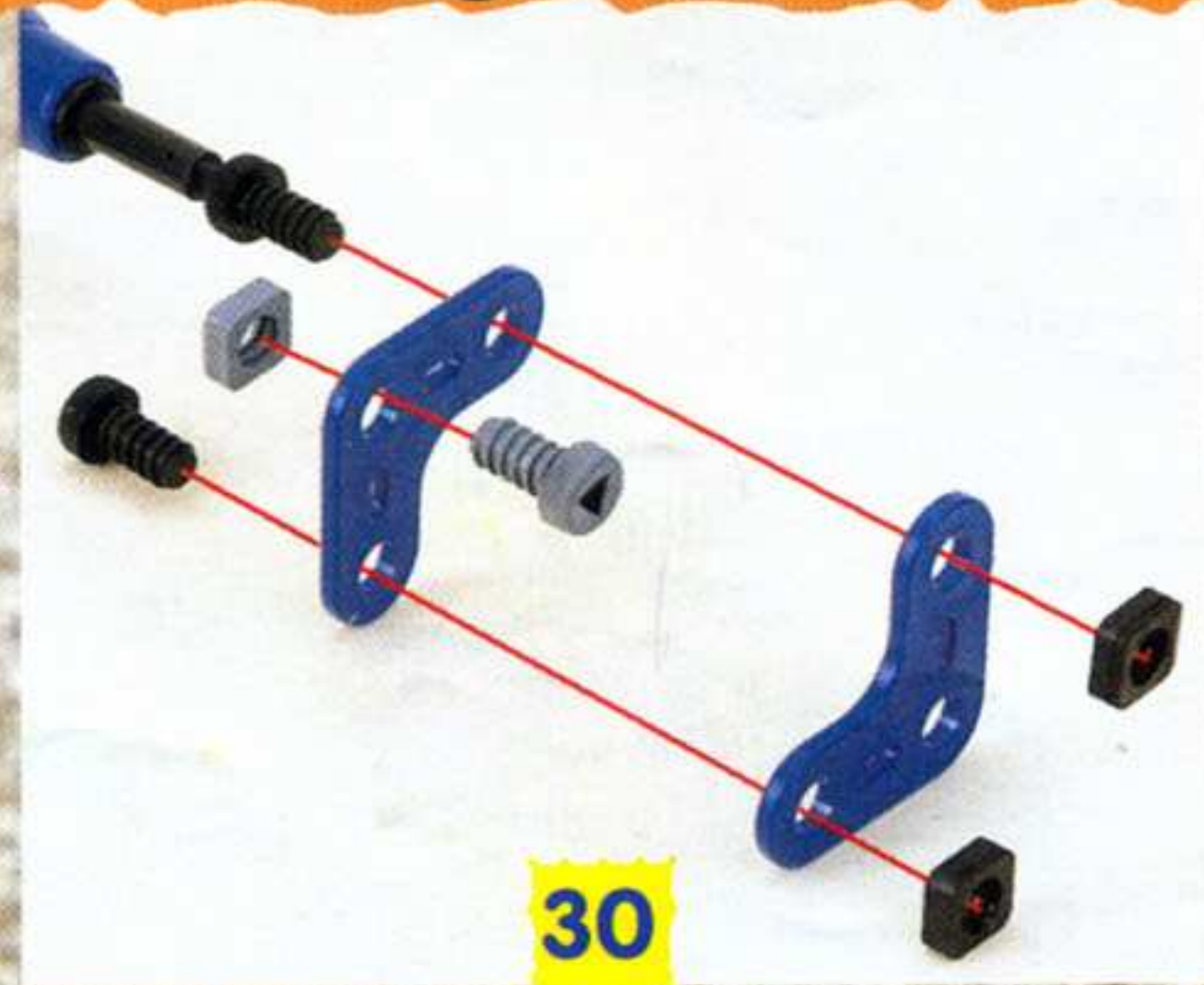

30



2



3

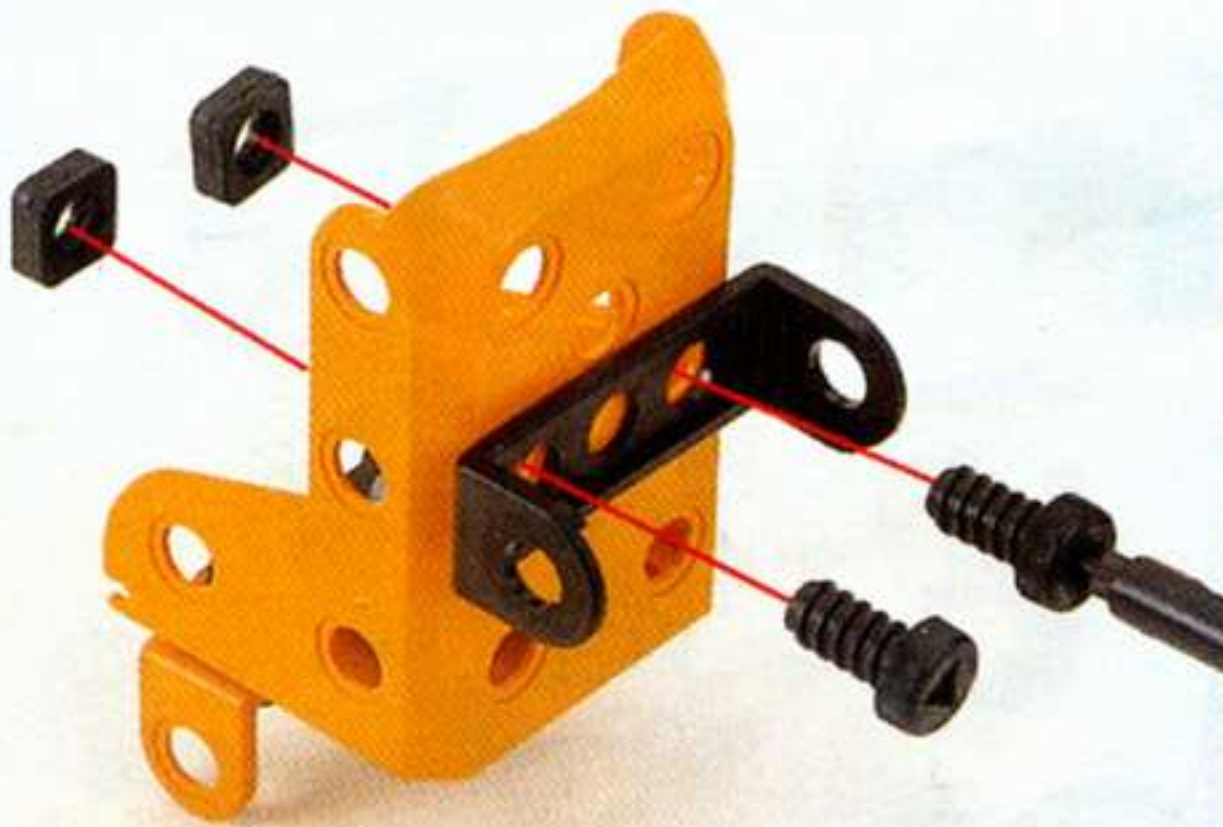
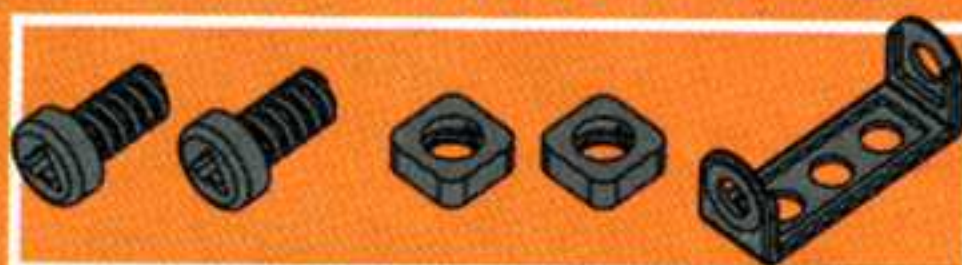

4

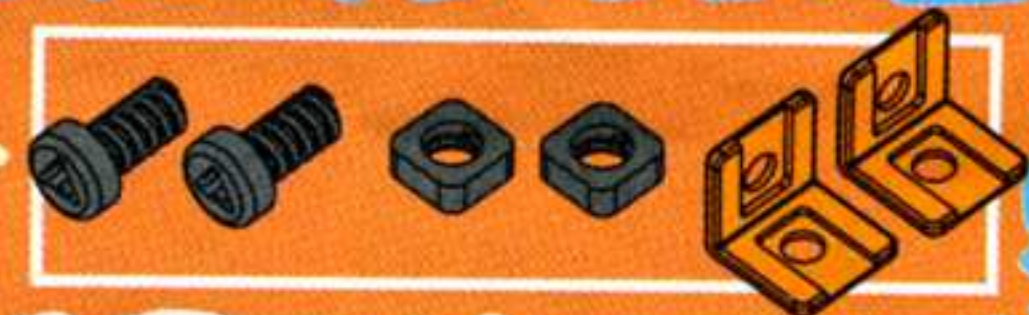

8

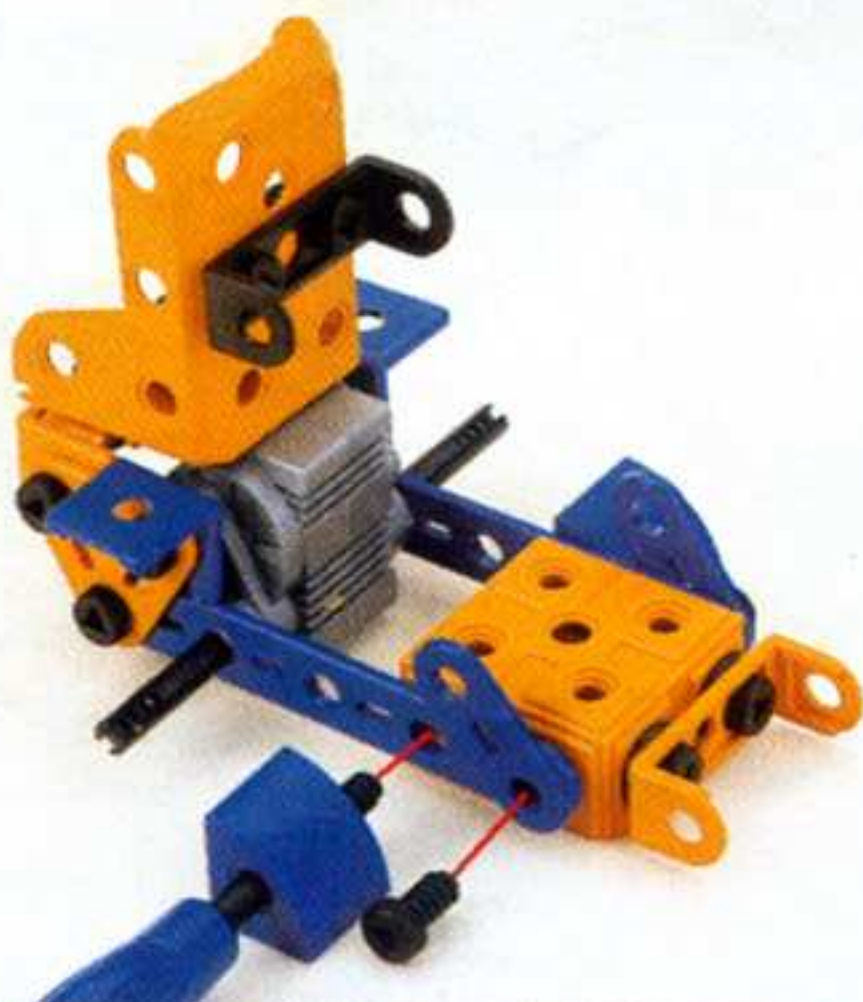

9

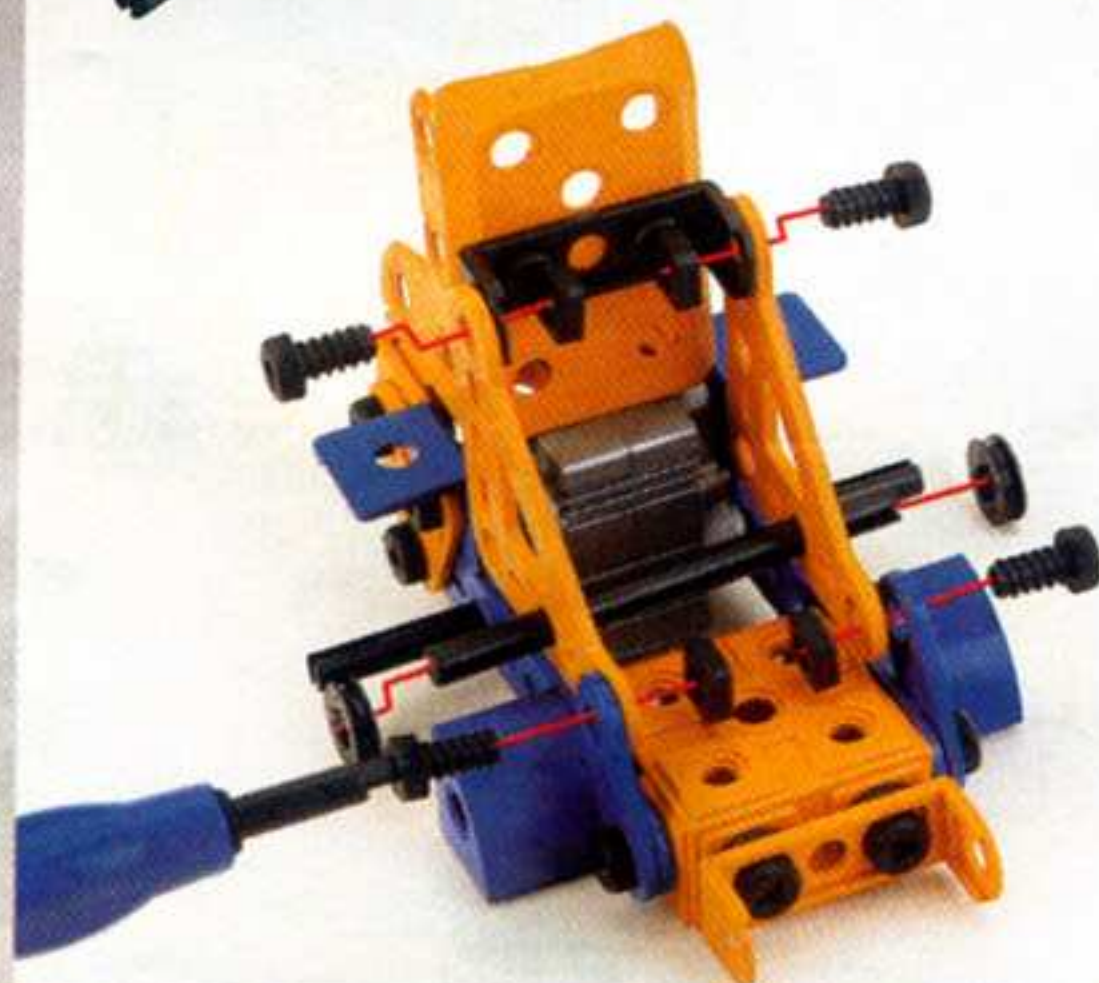

10



14



15



16

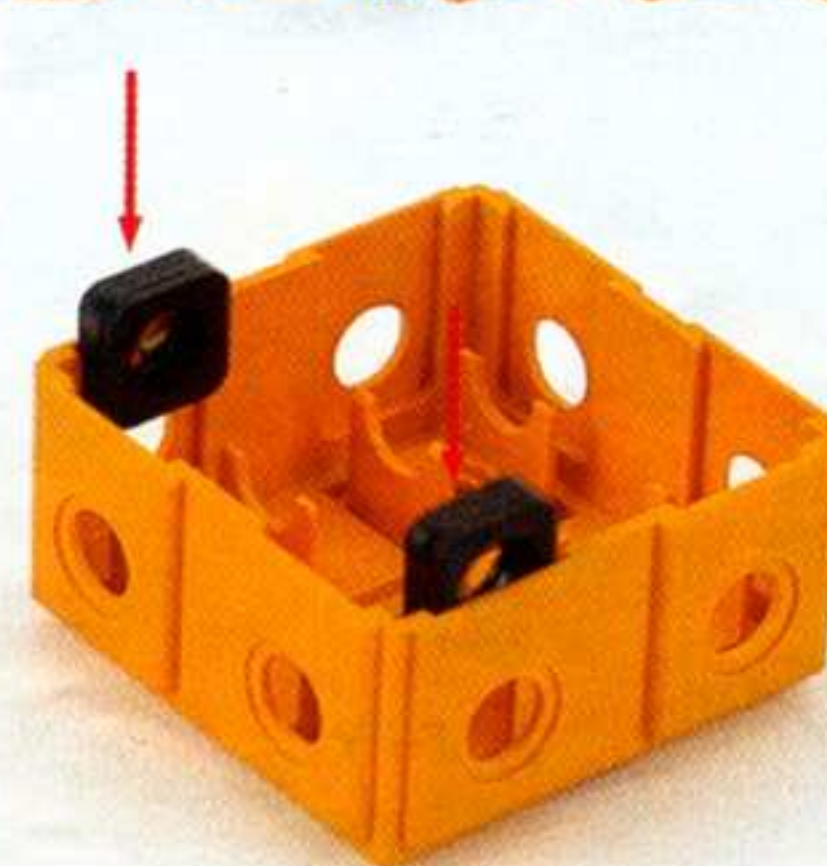

31

17



18



19



23



24



25



1

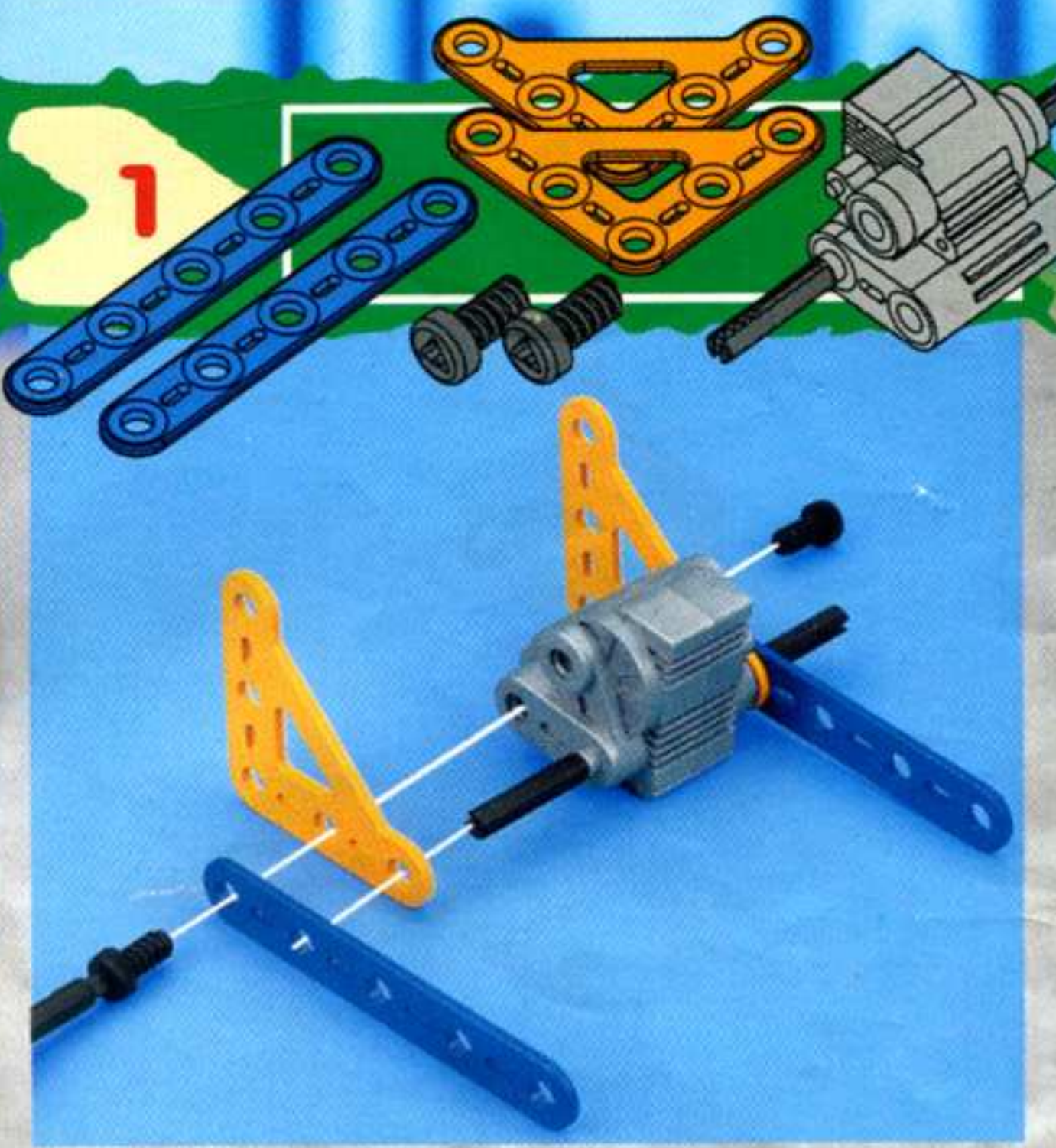

5



6



7

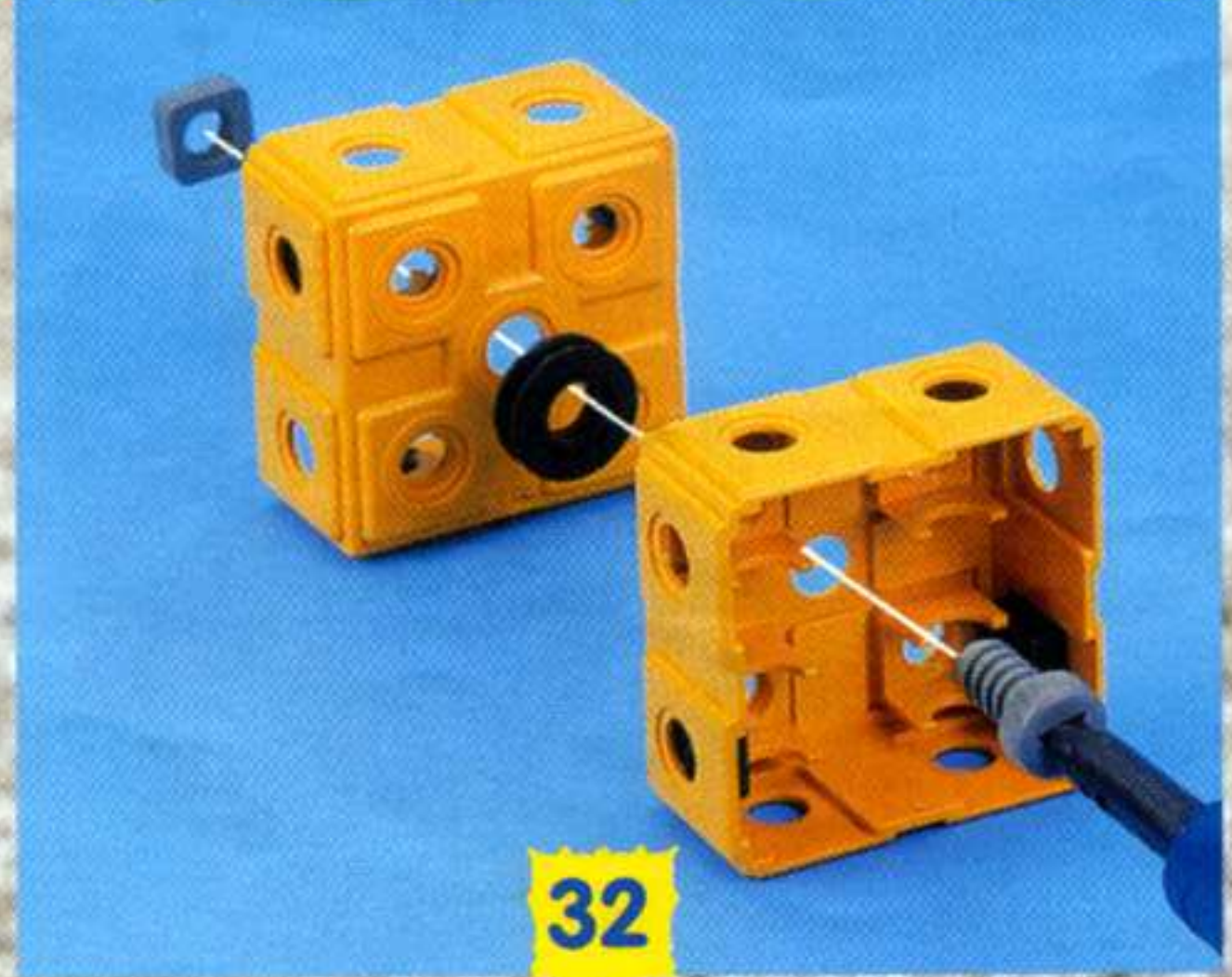

32

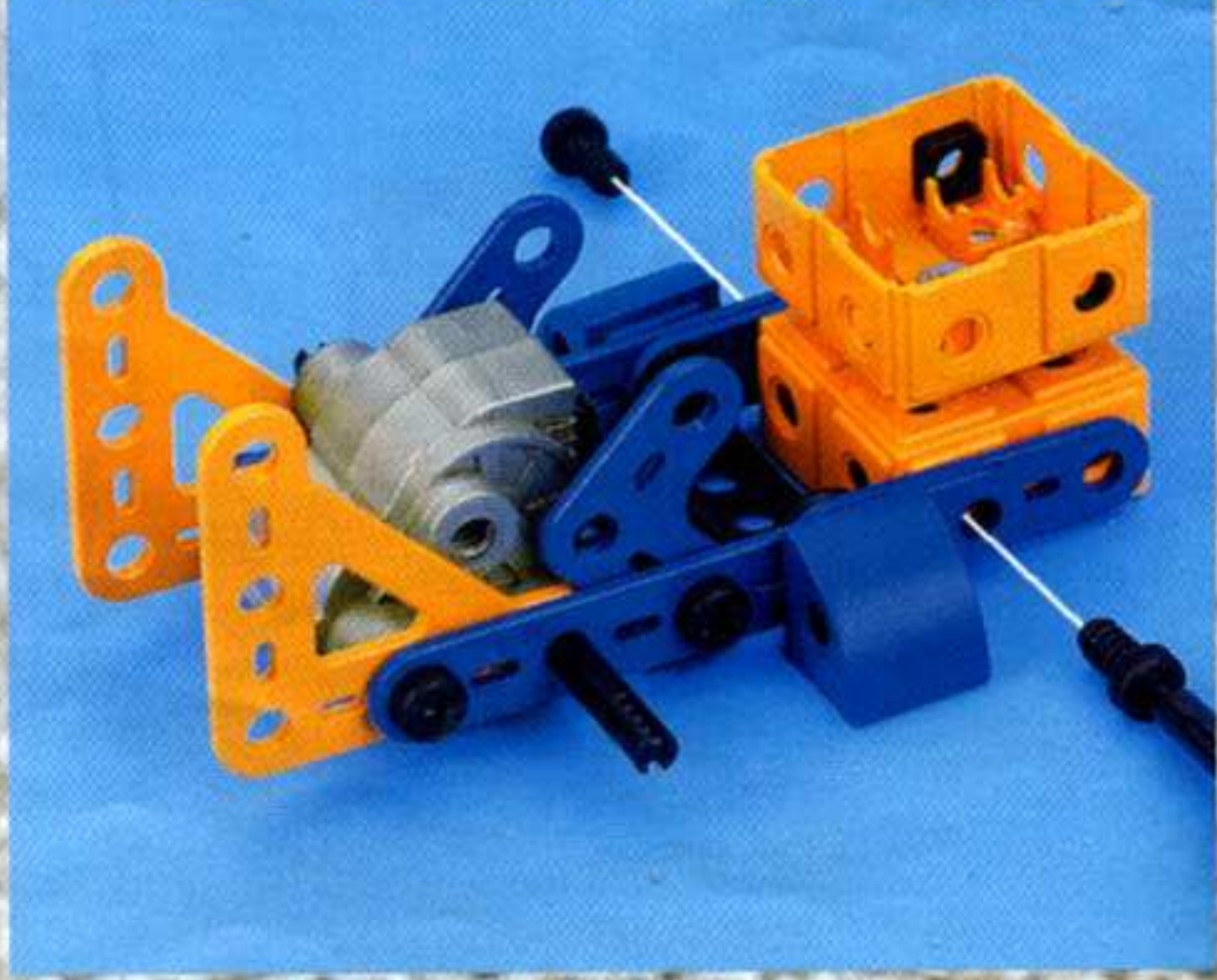



20



21



22

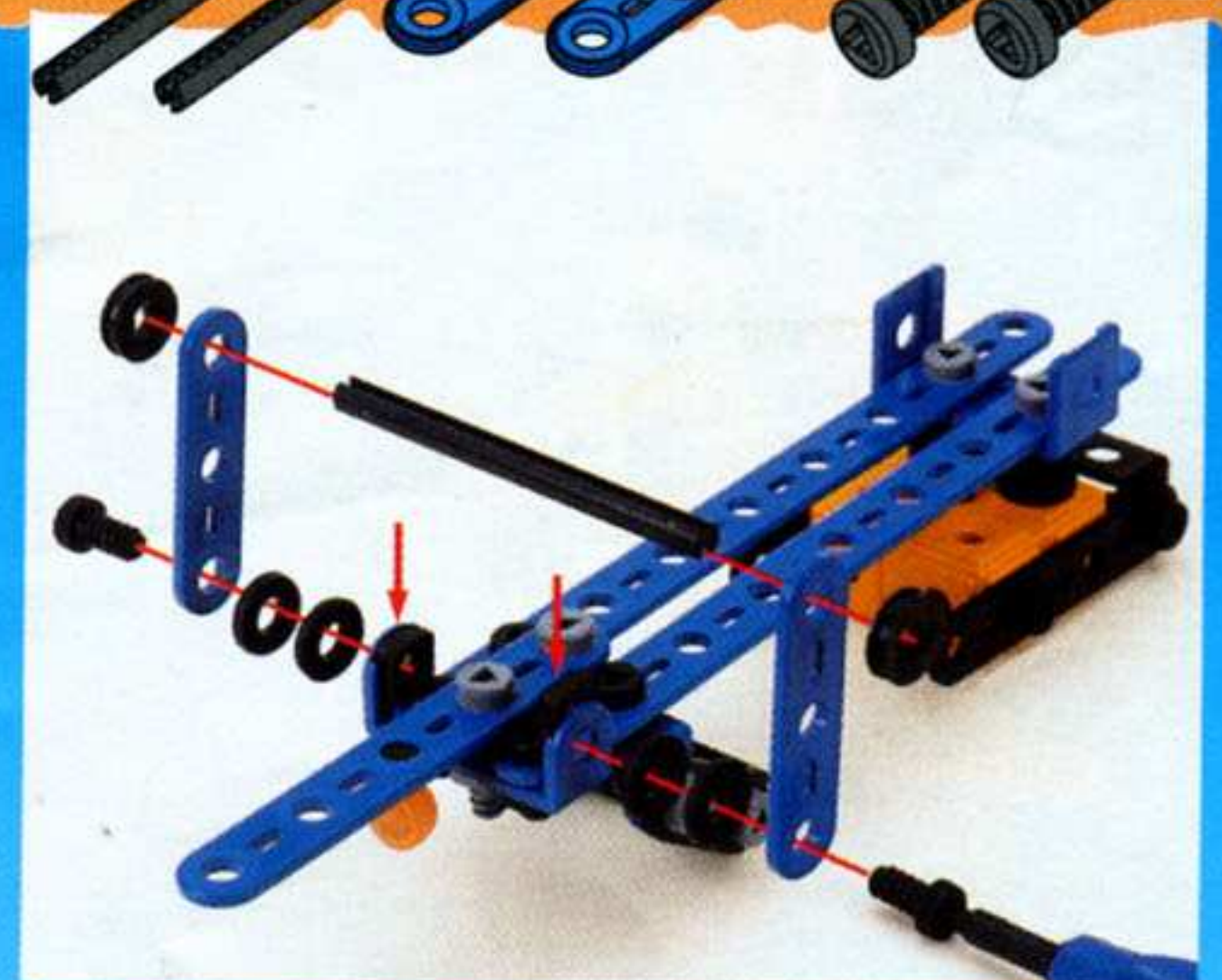
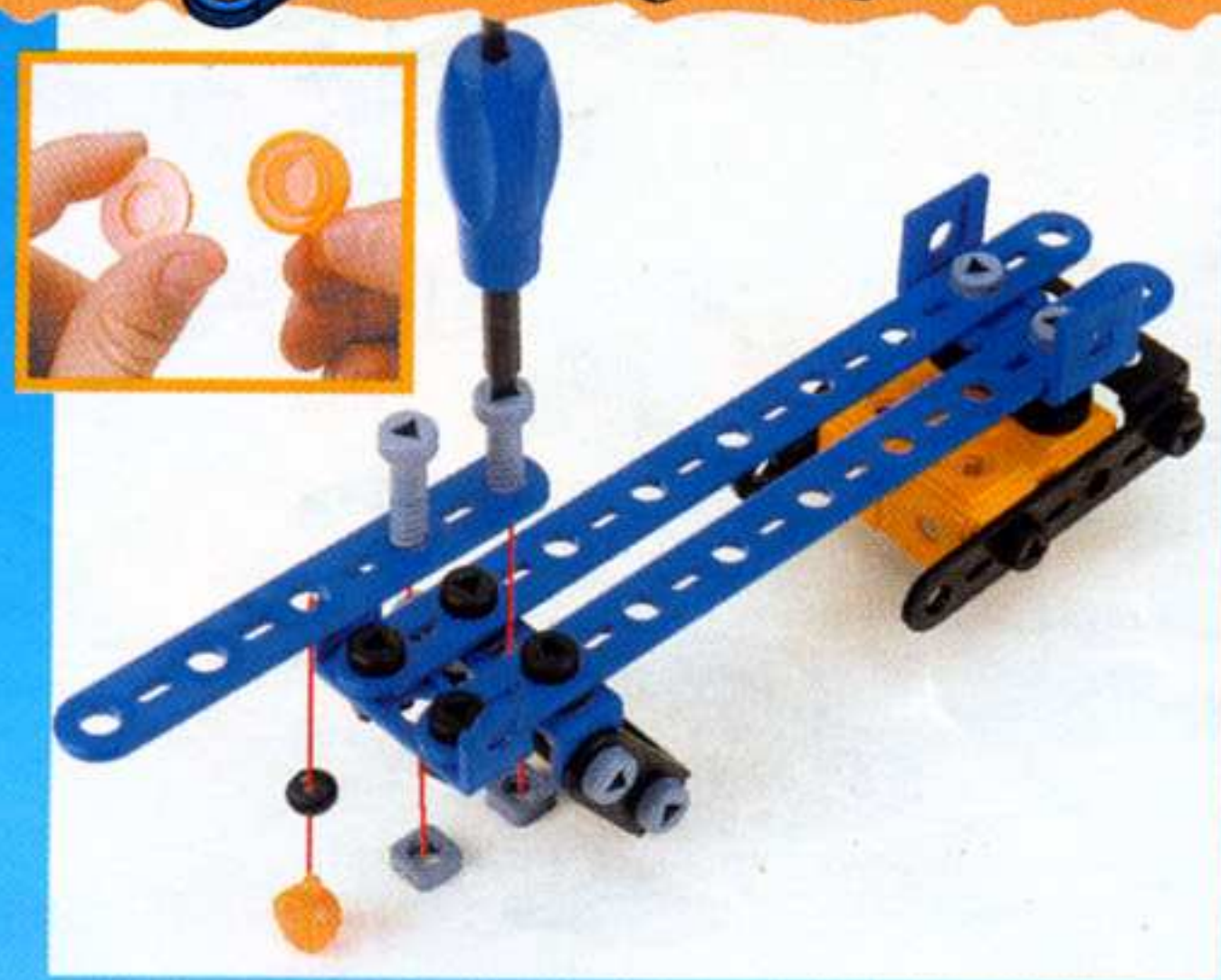
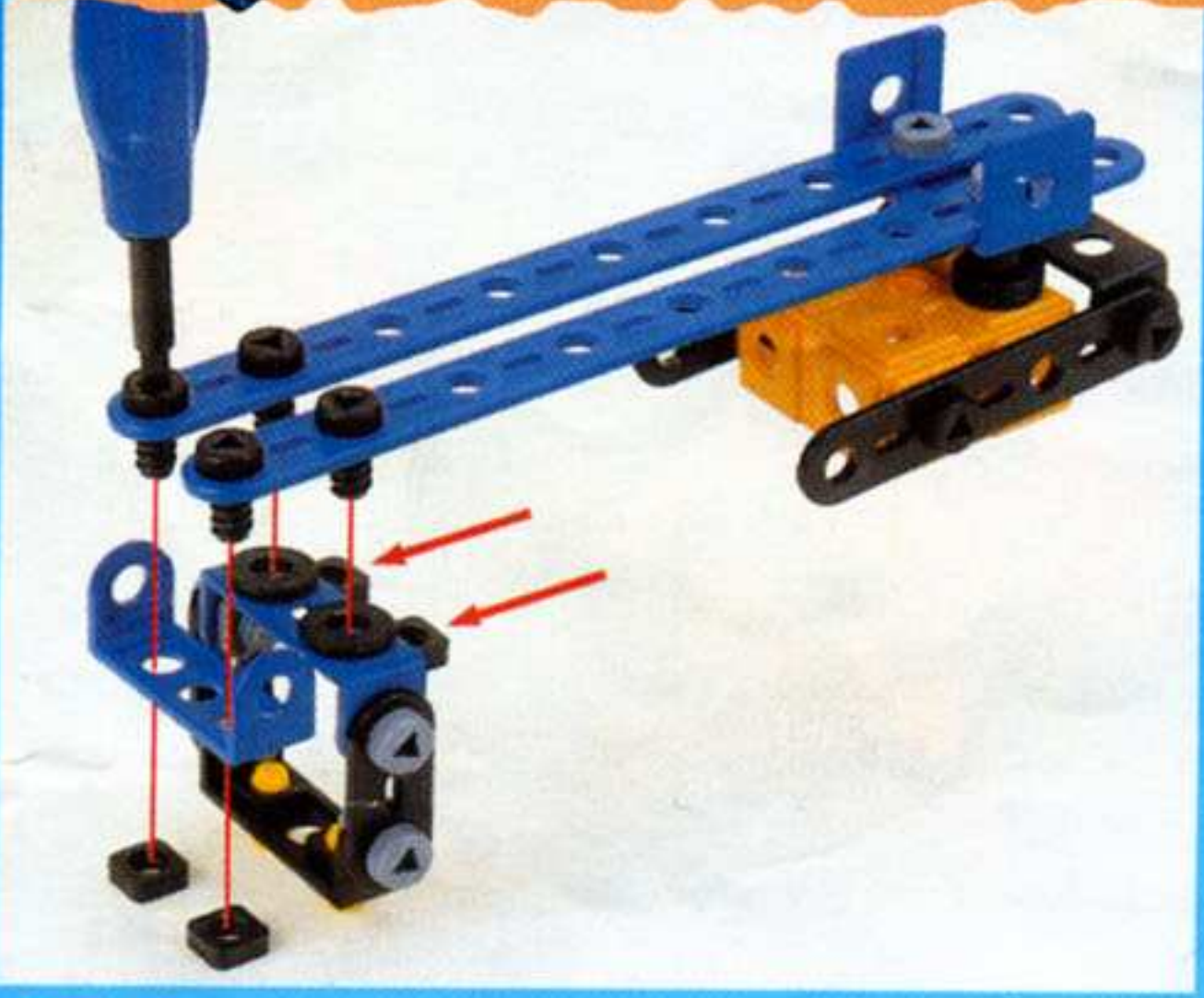

2



3



4

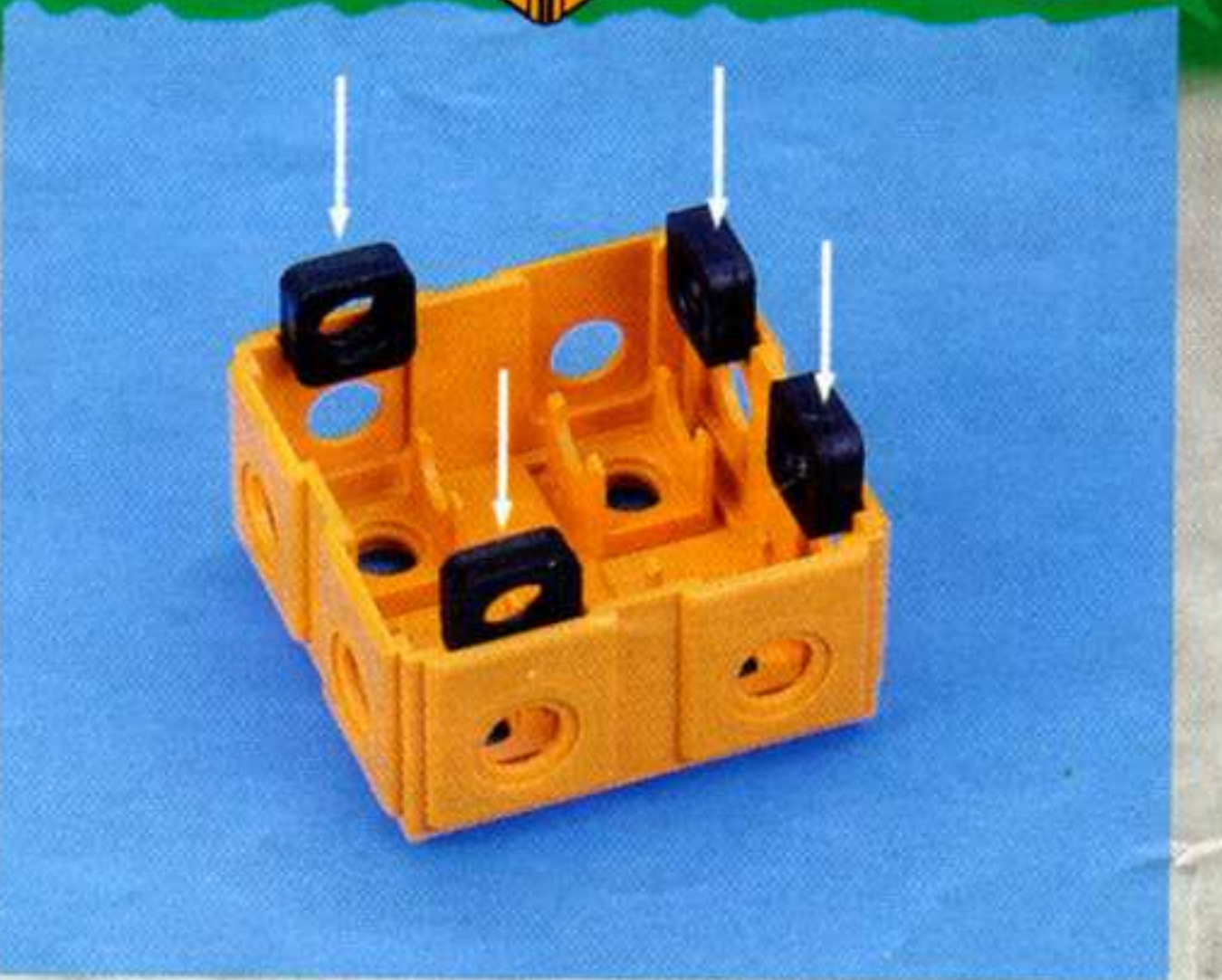
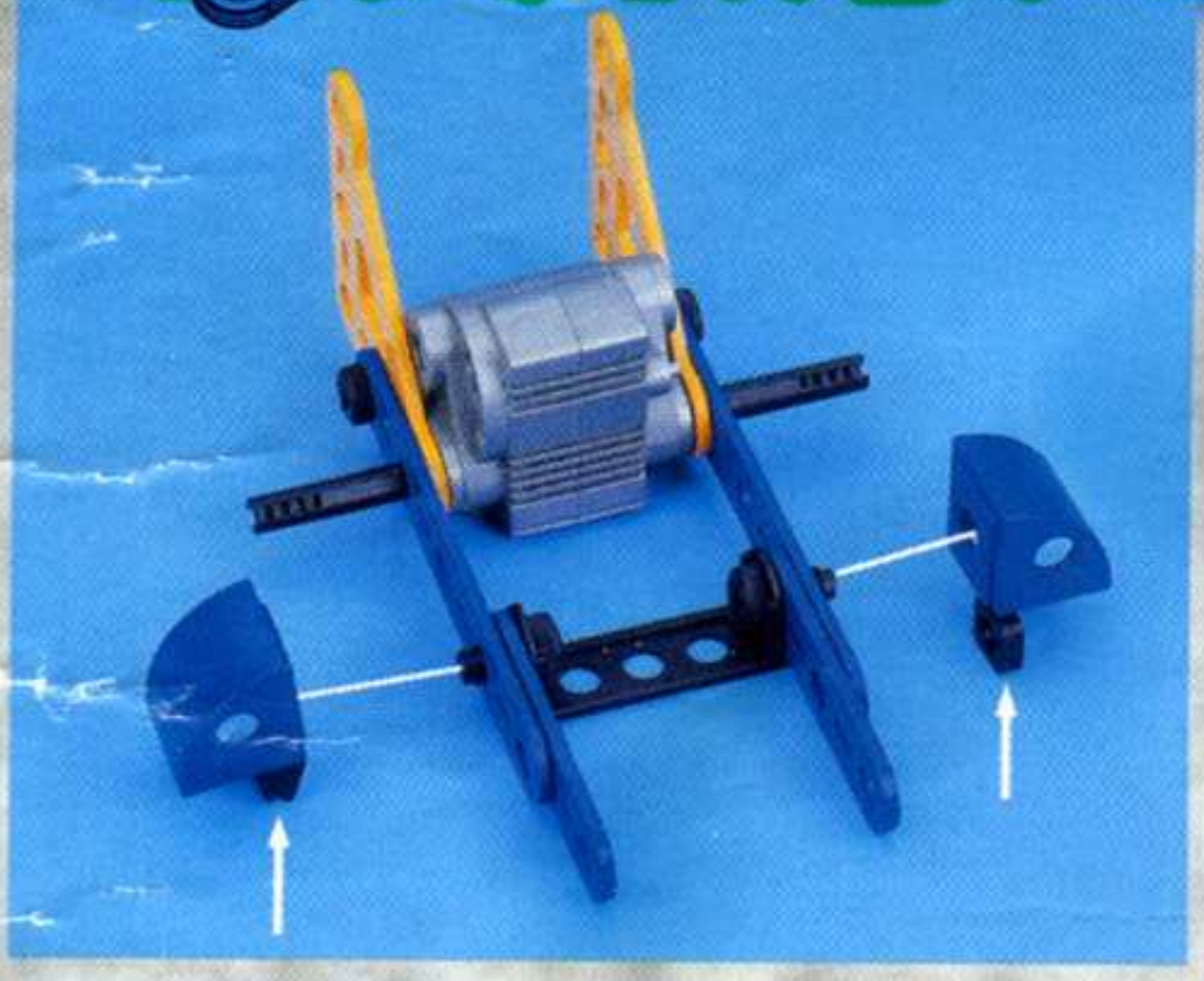

8



9



10

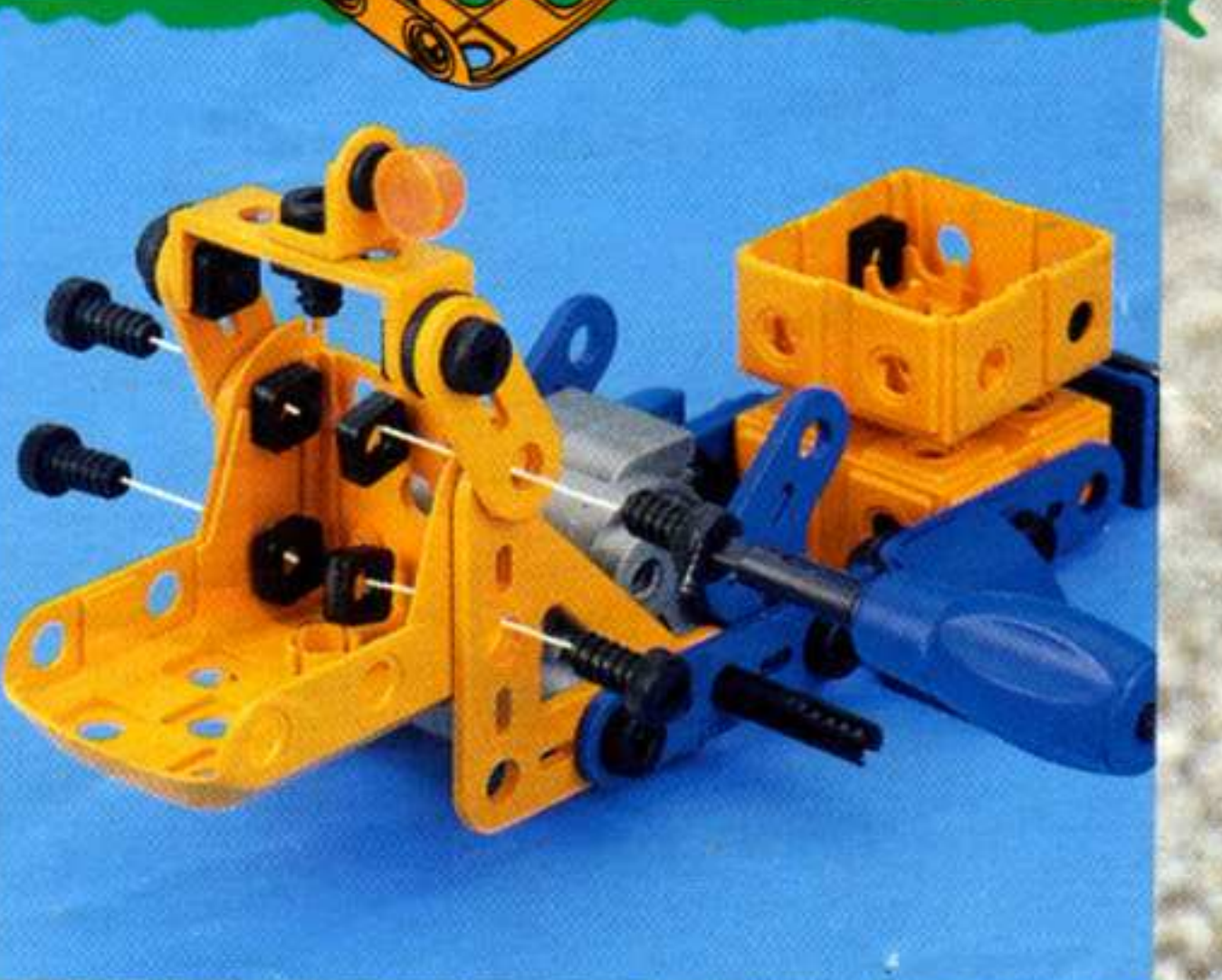
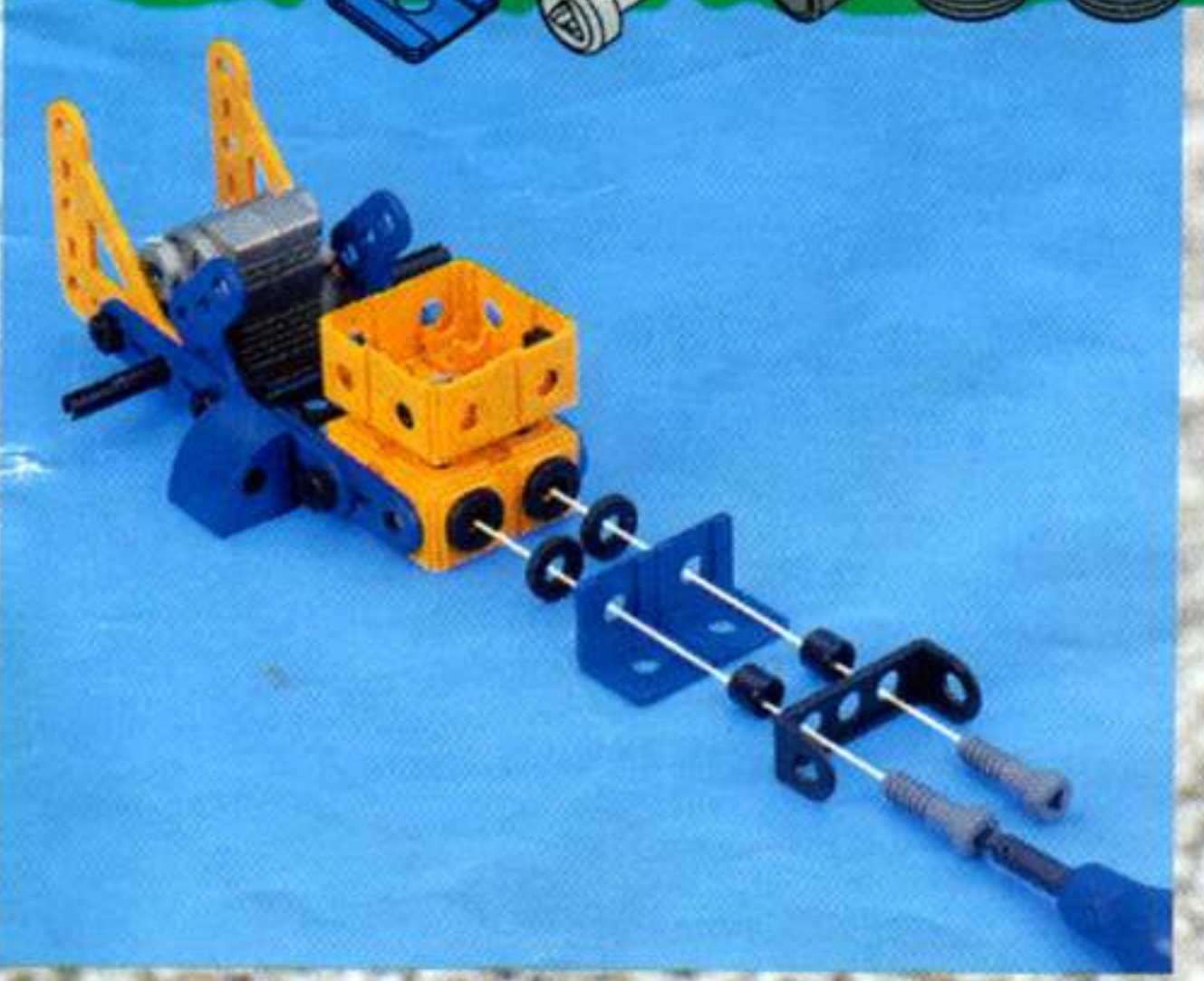
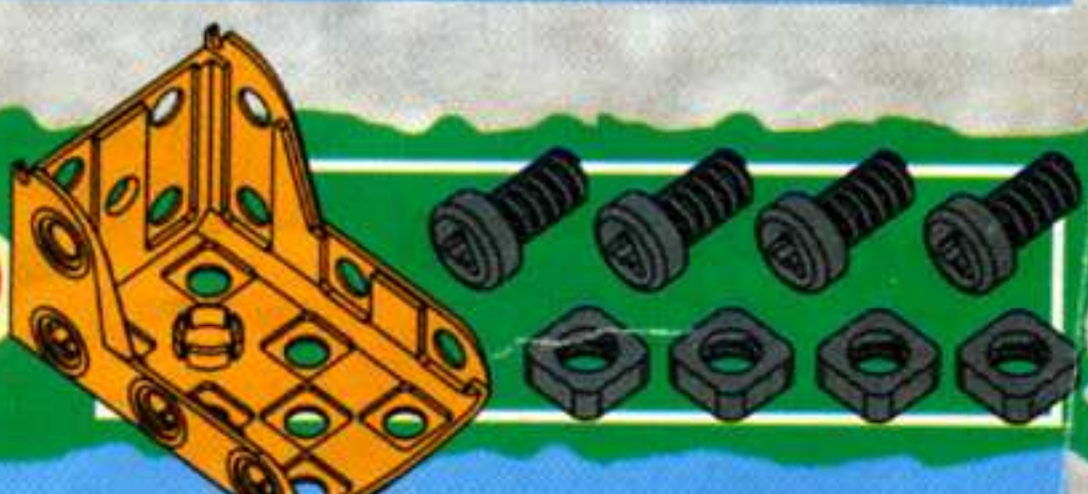

11

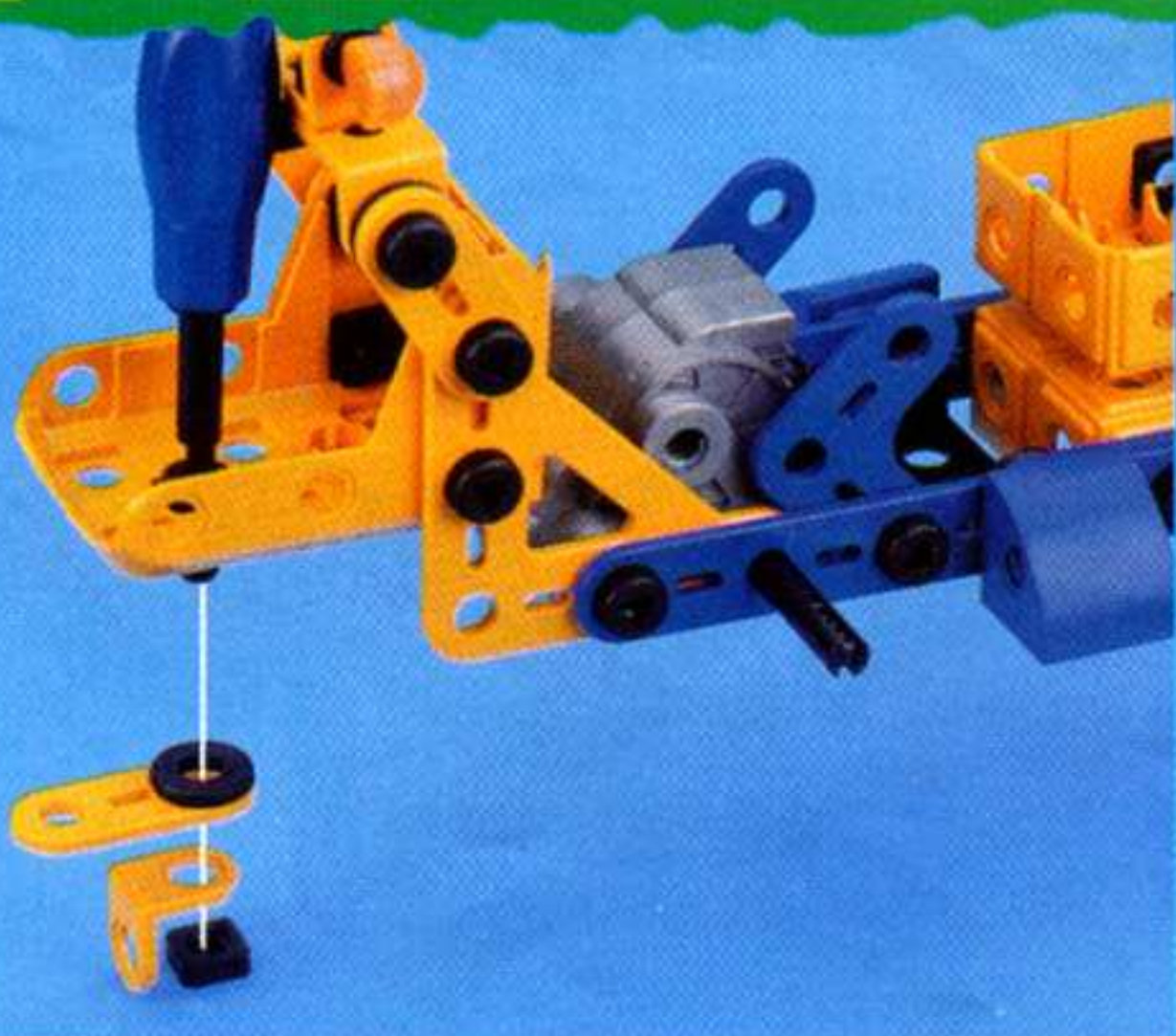

12



13

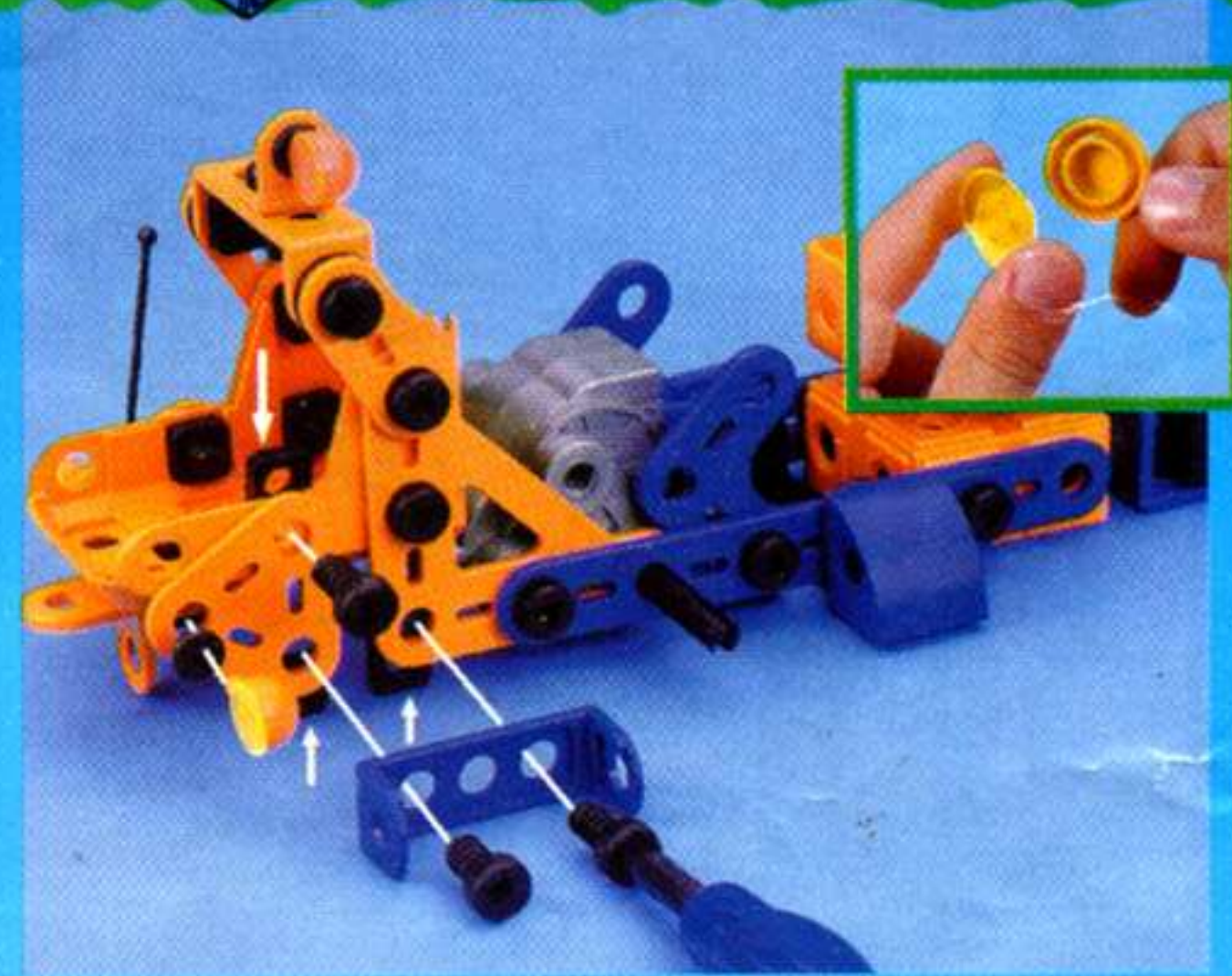

17

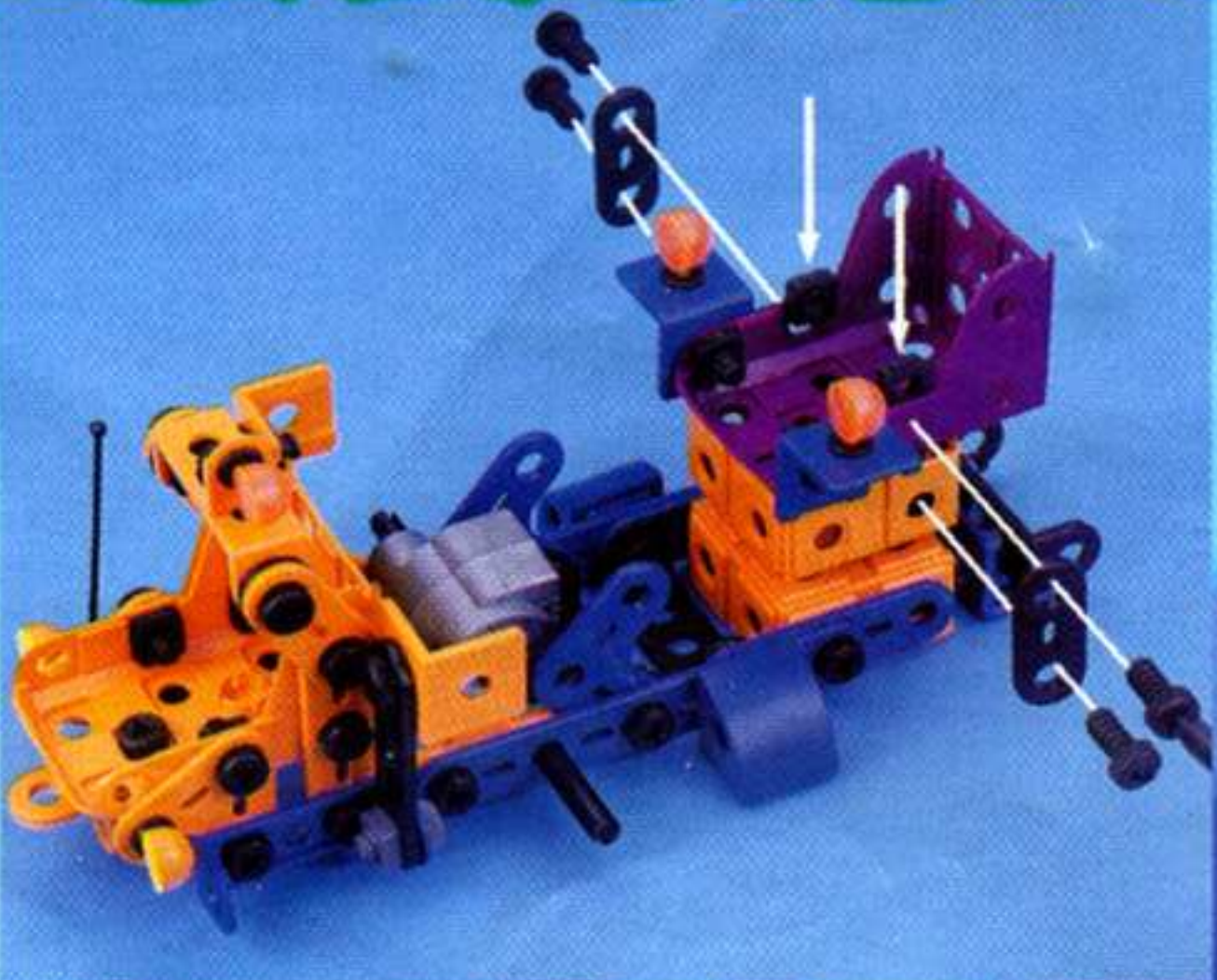

18

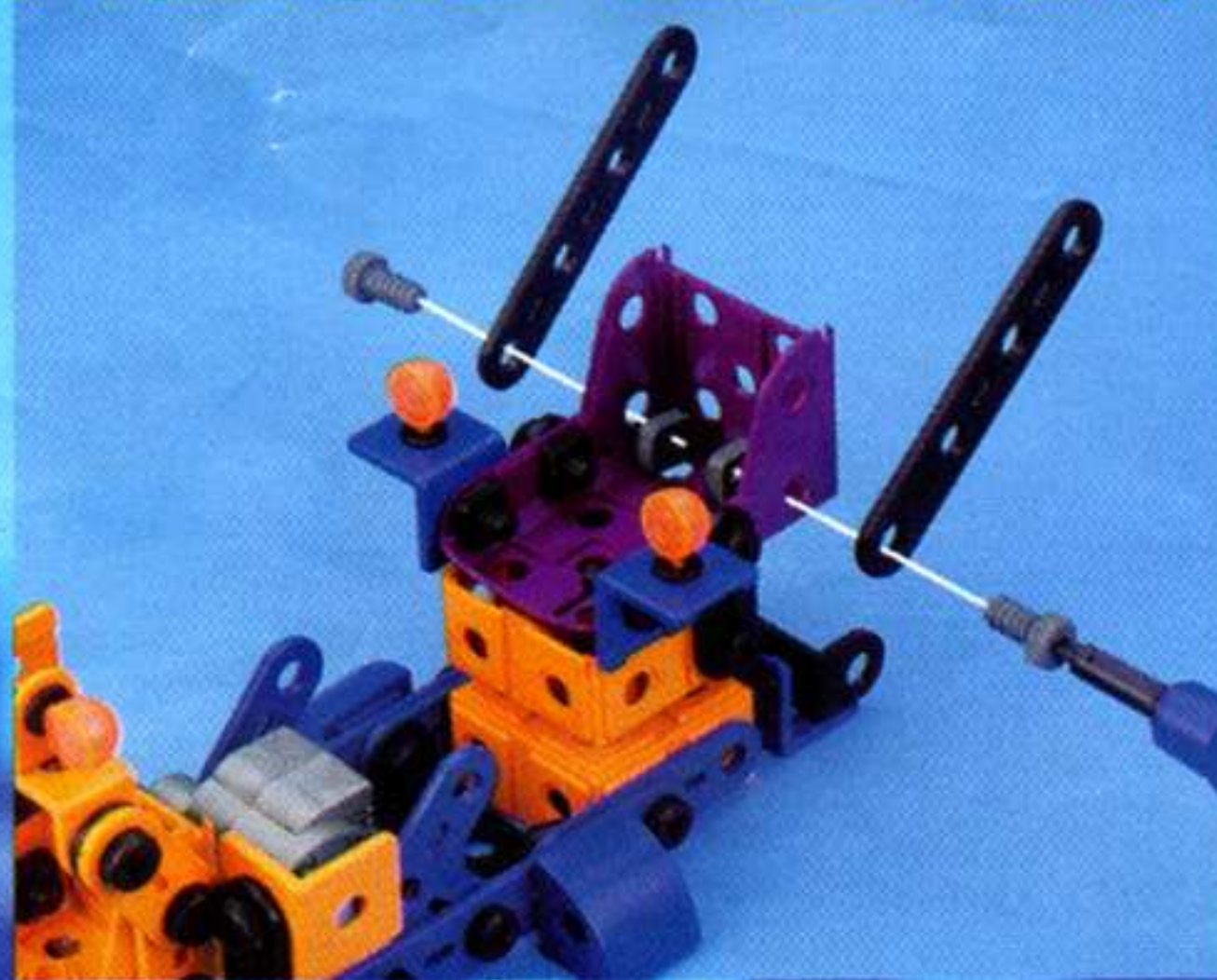
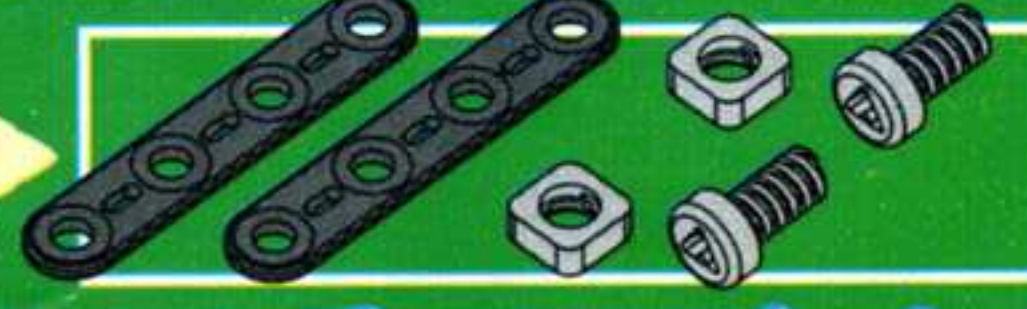

19

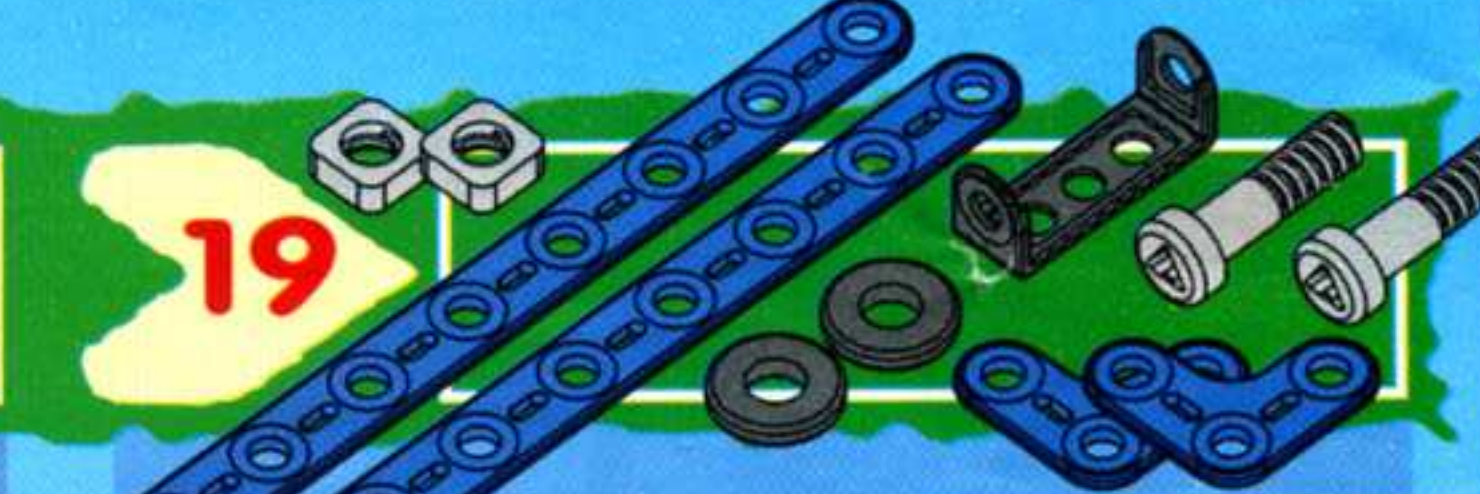

23

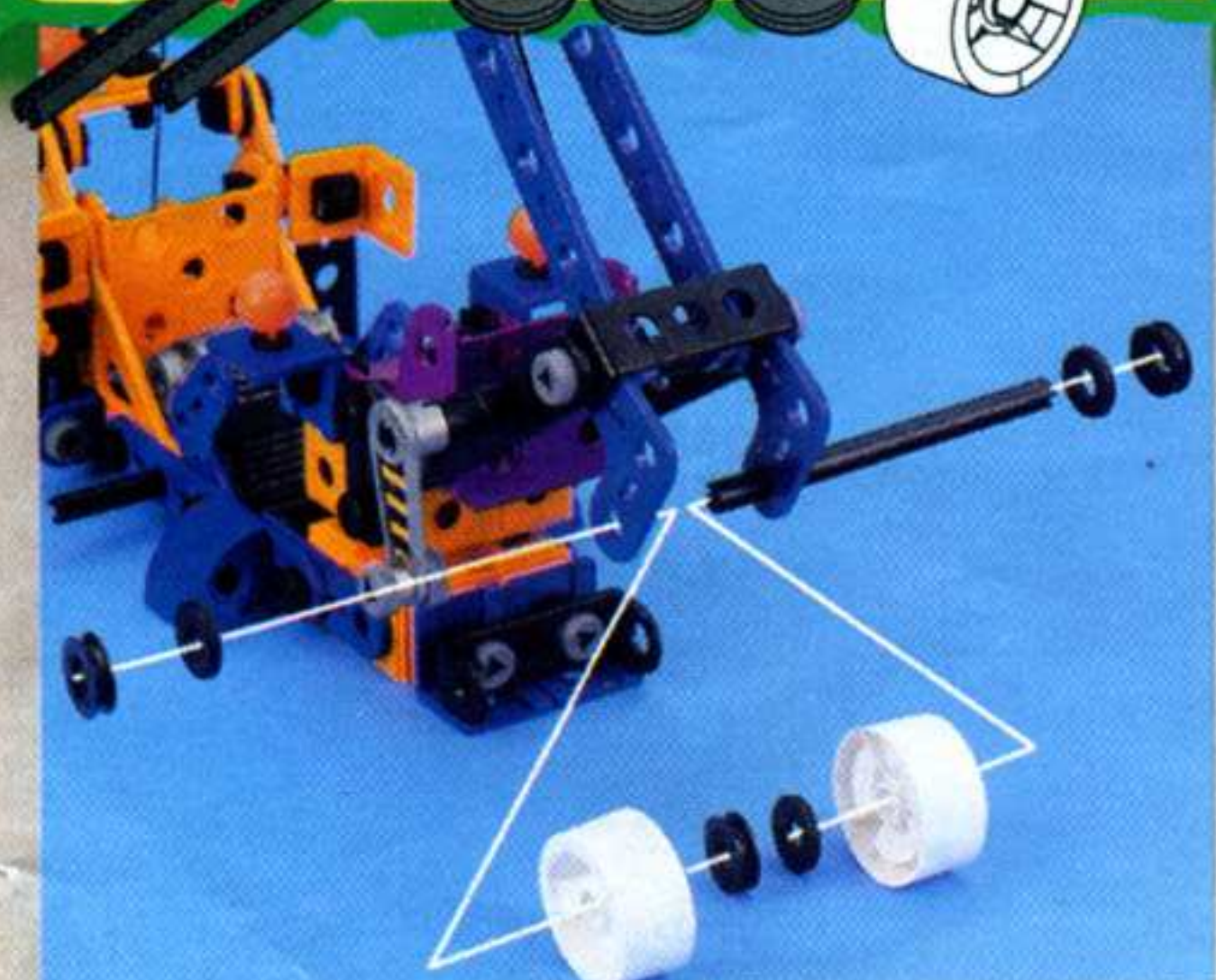
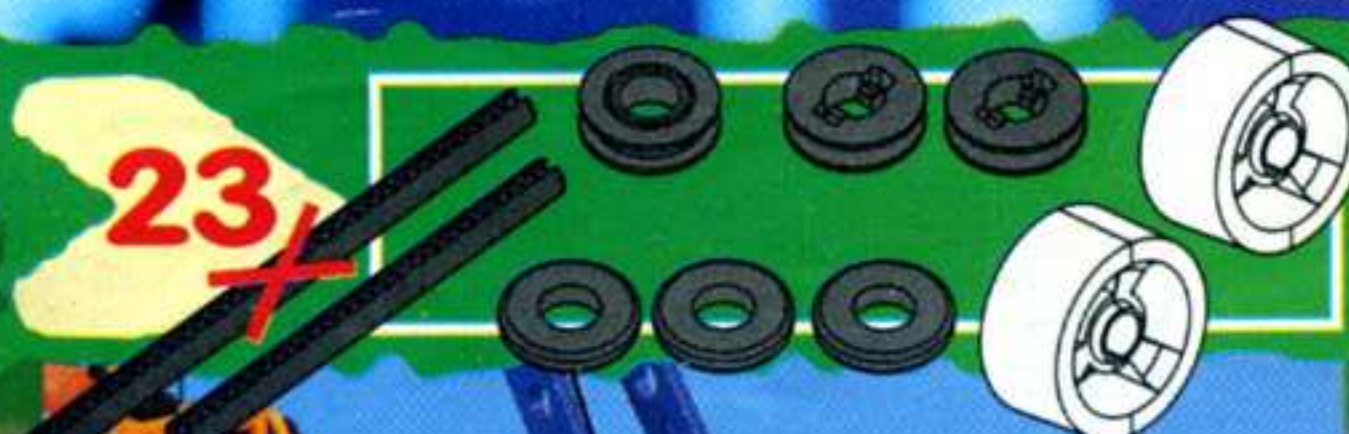

24

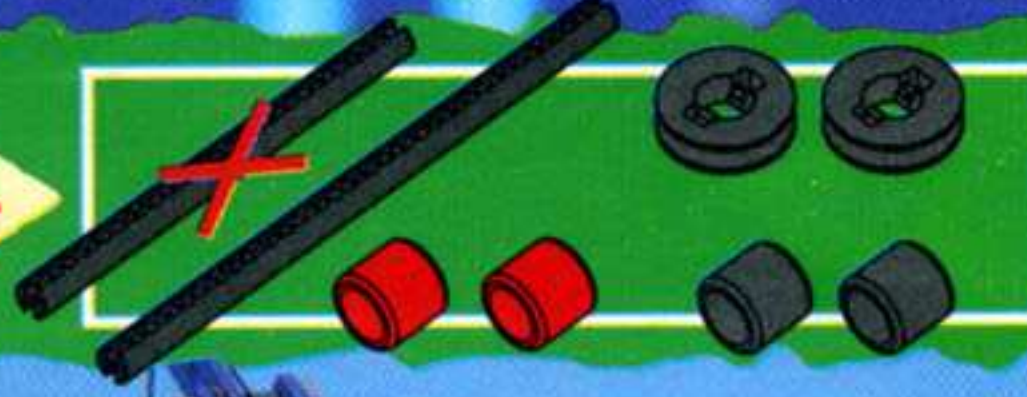

25



29

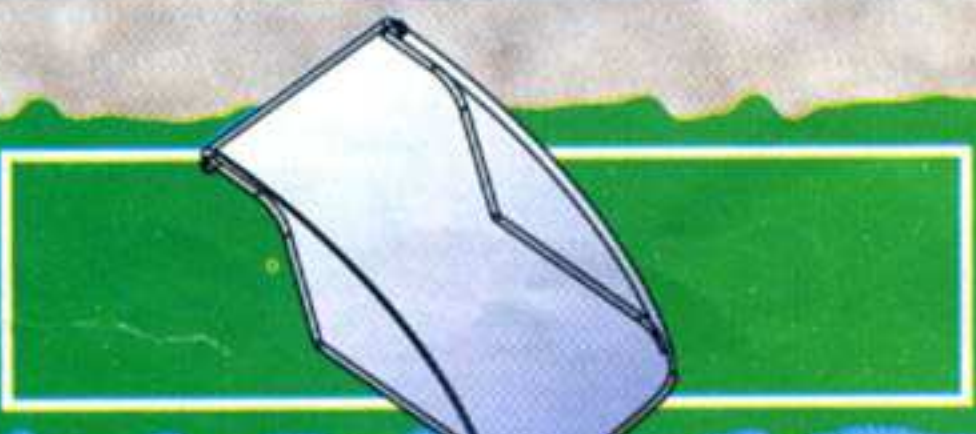

30



34



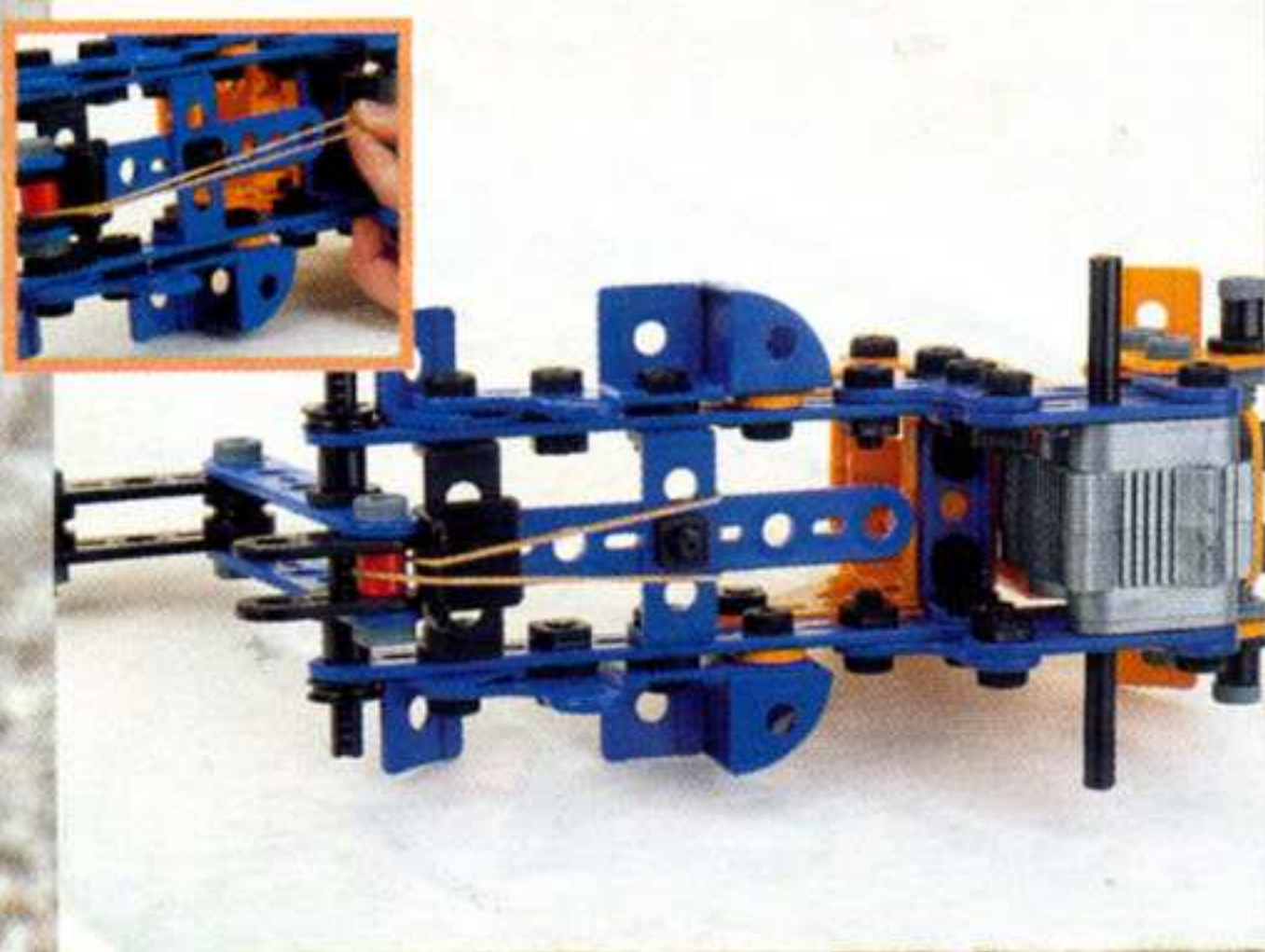
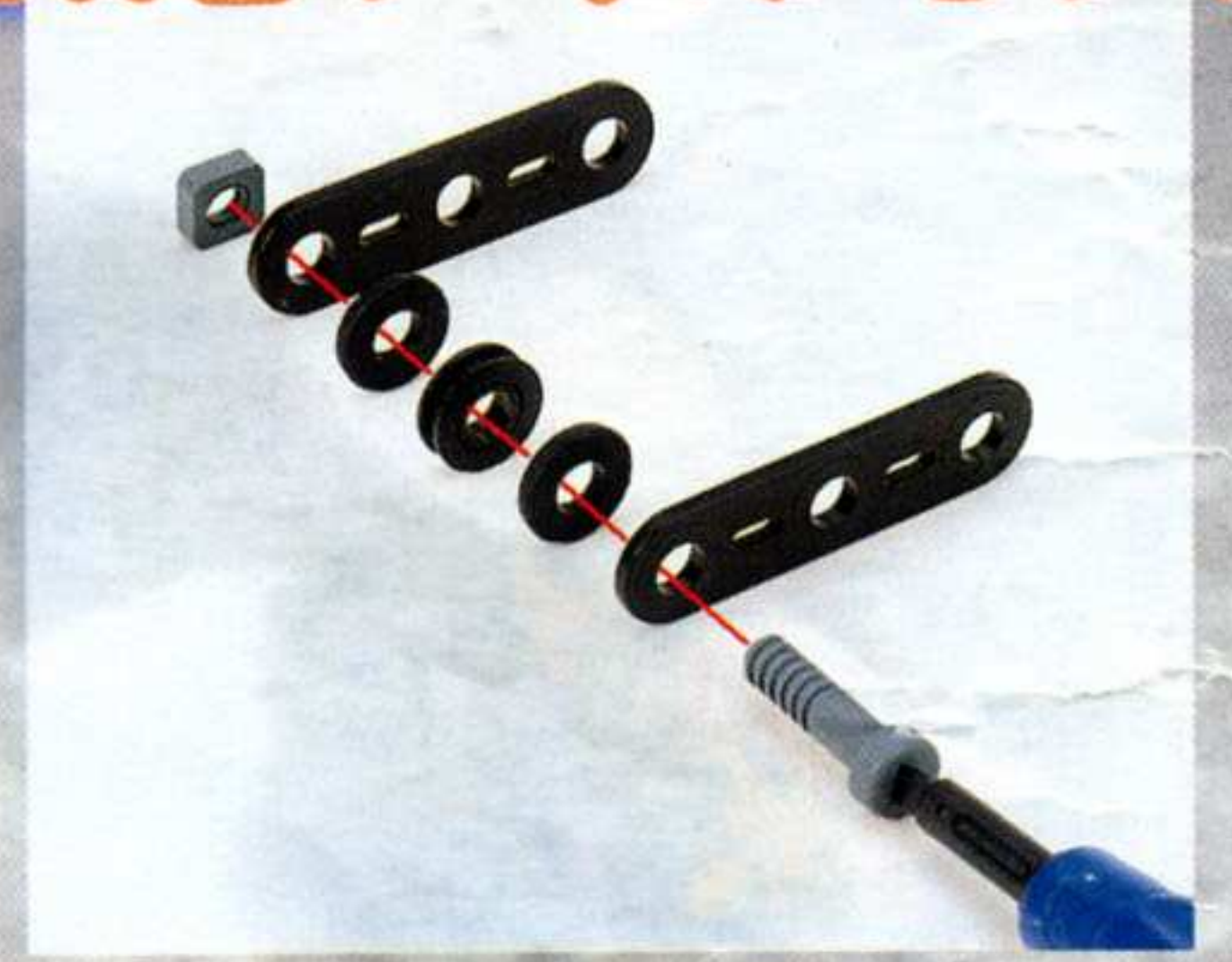
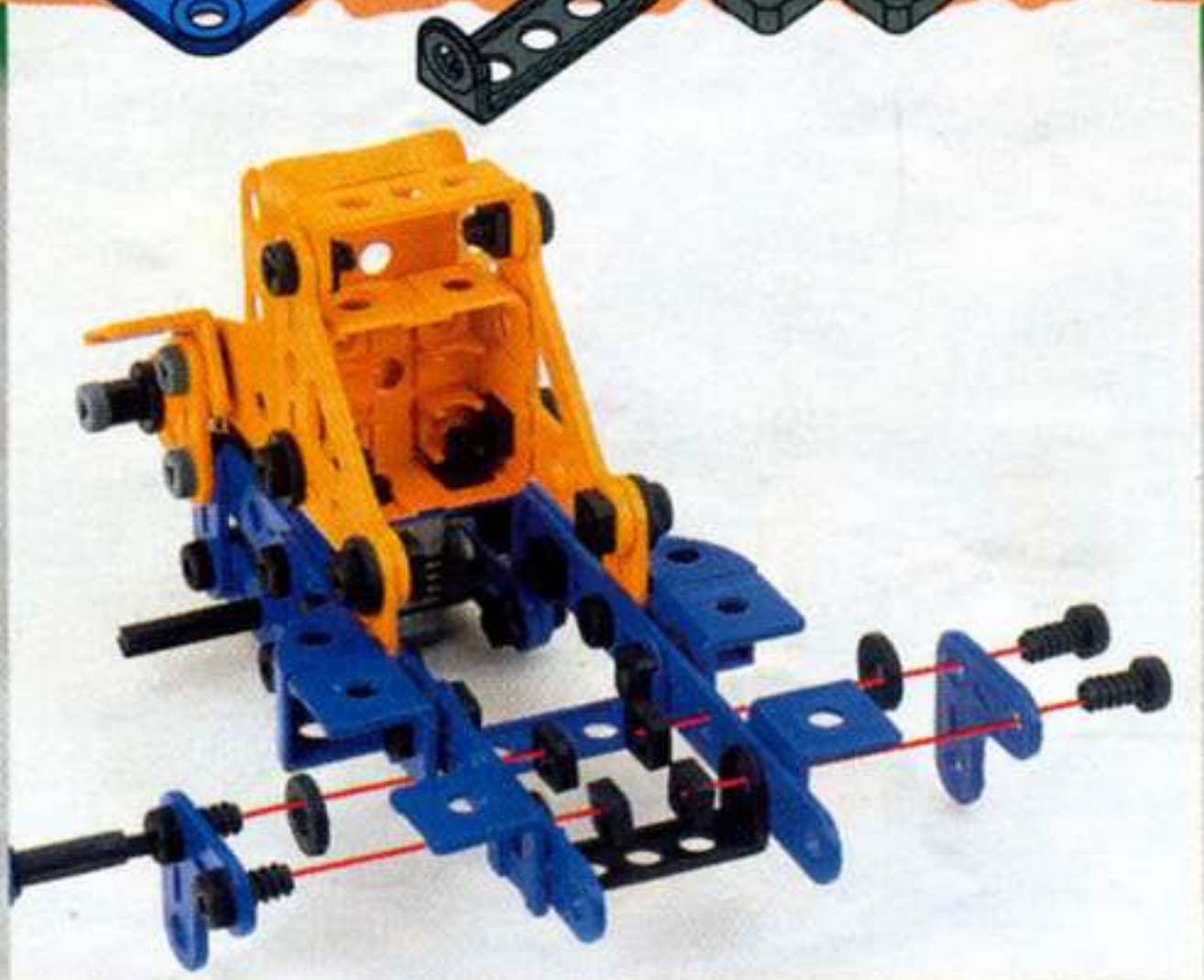
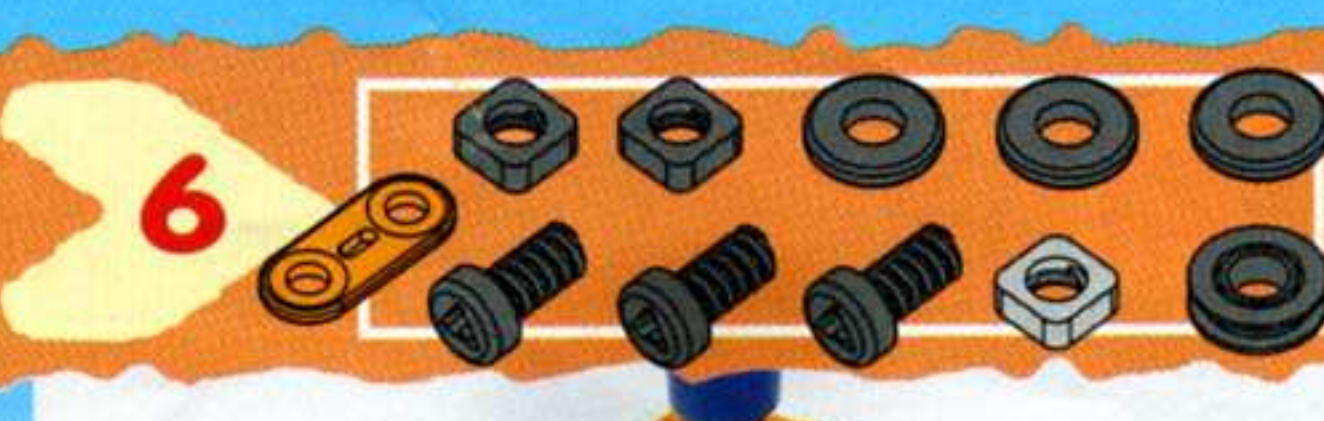
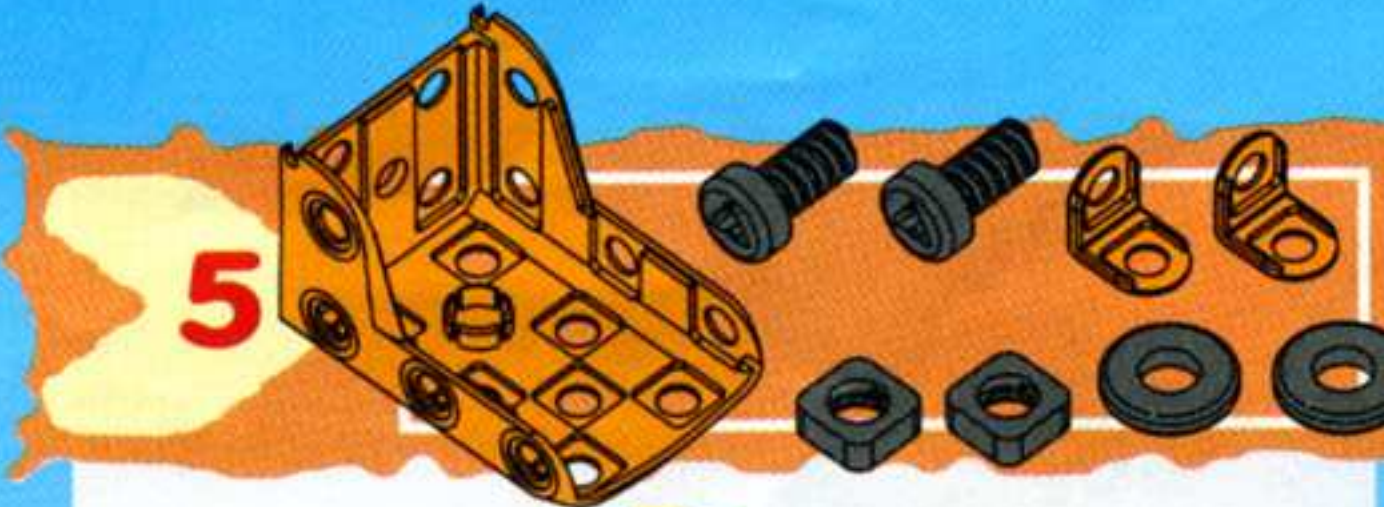

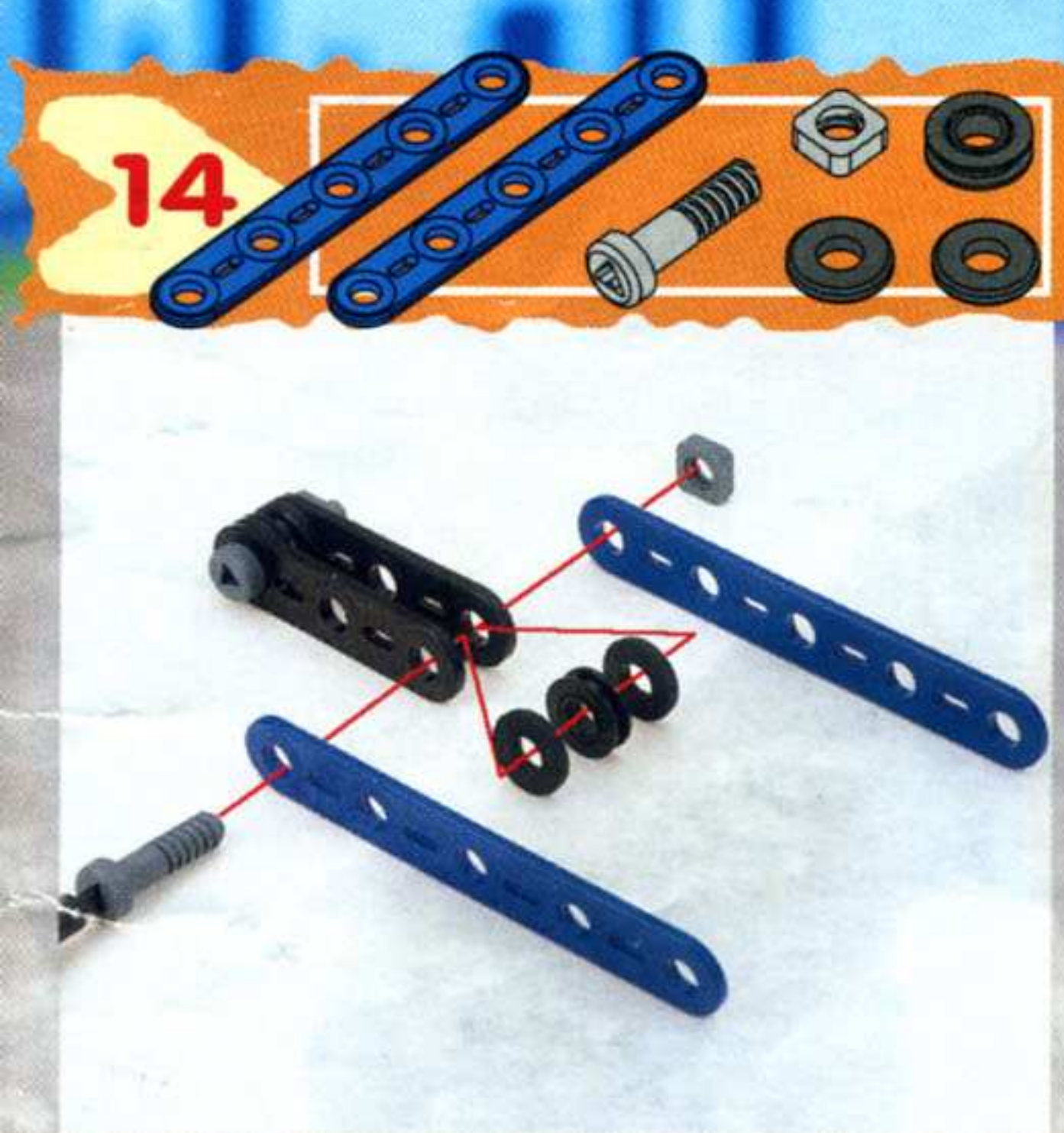
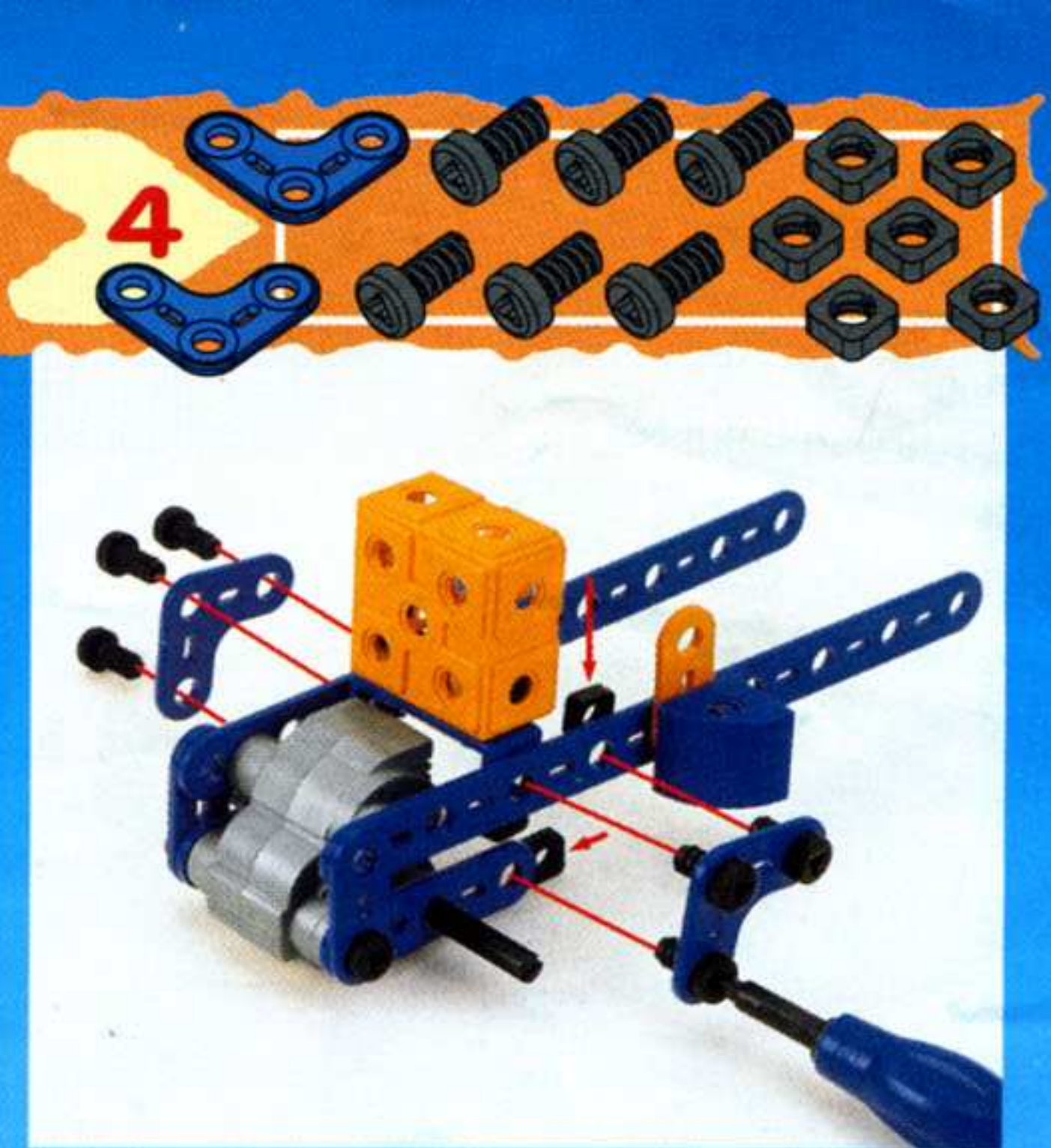
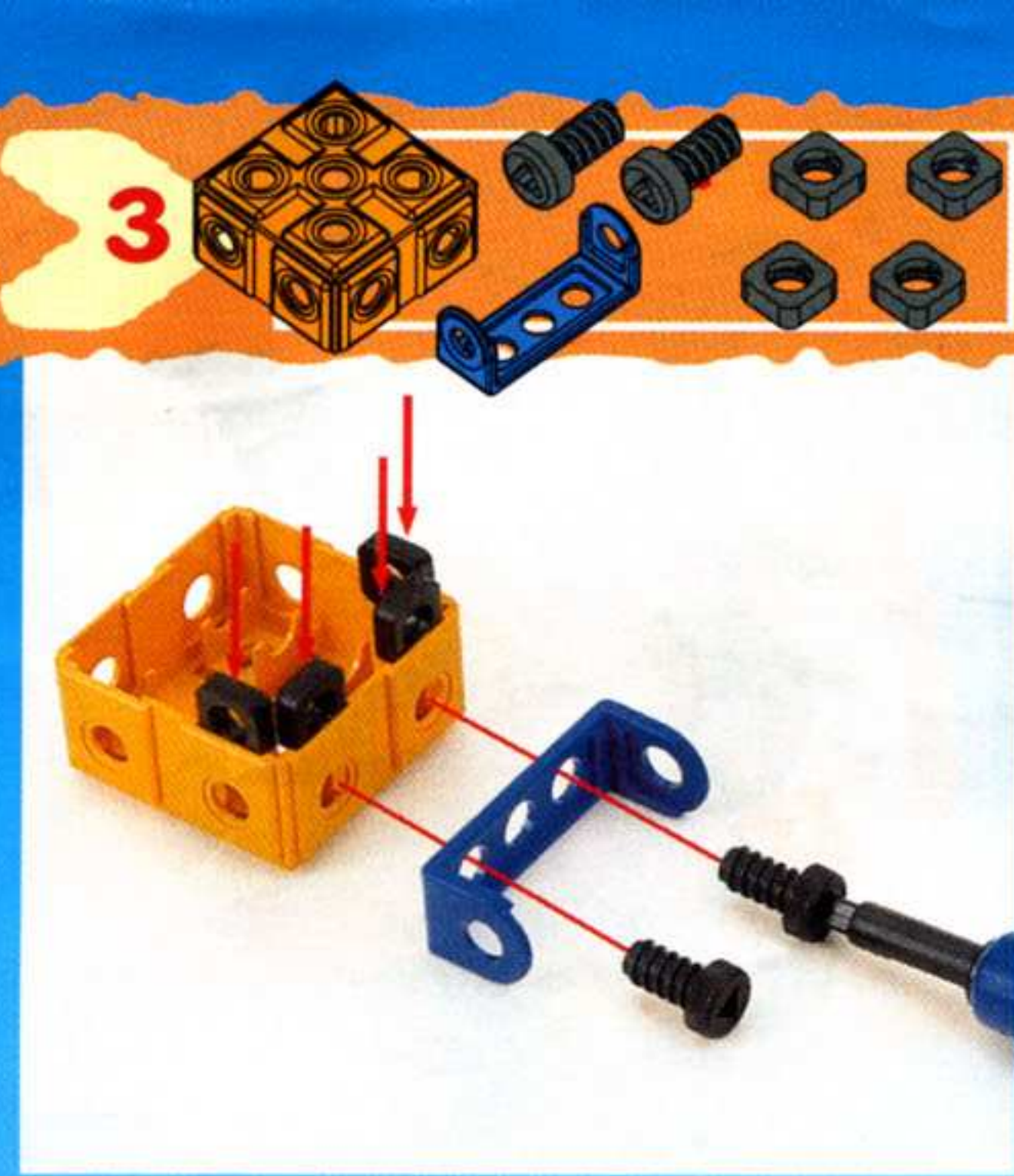

23



24



25



1

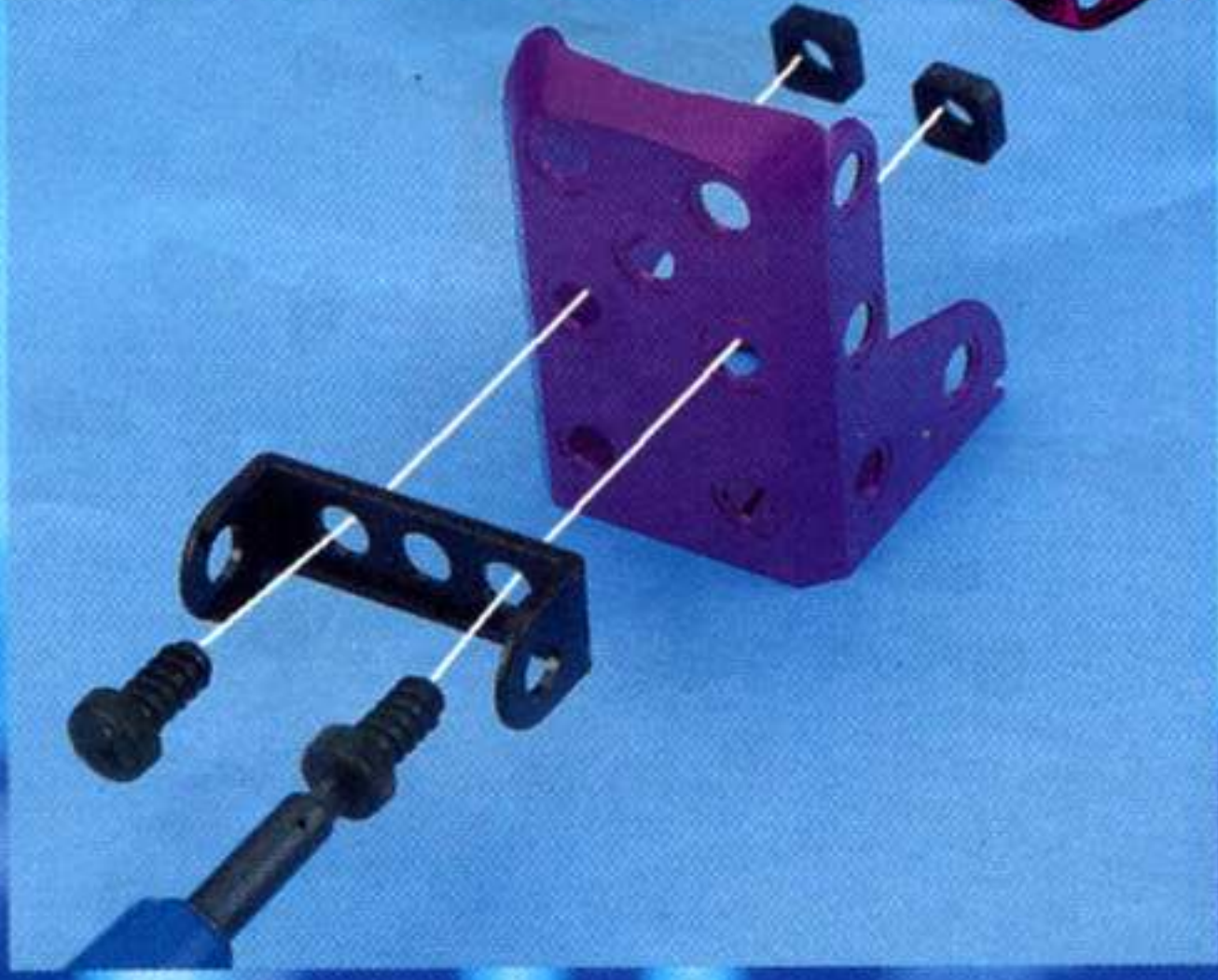

2

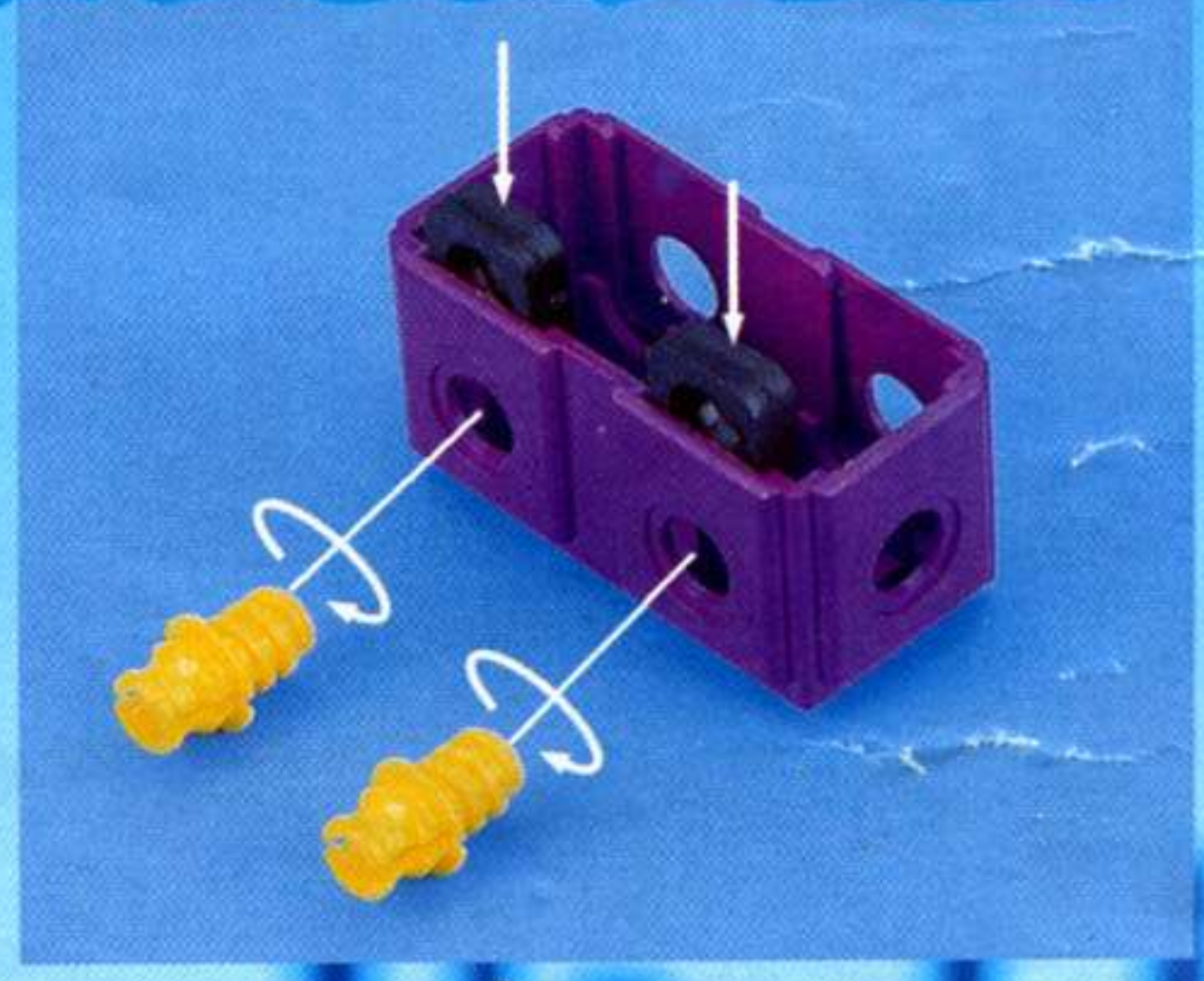

6

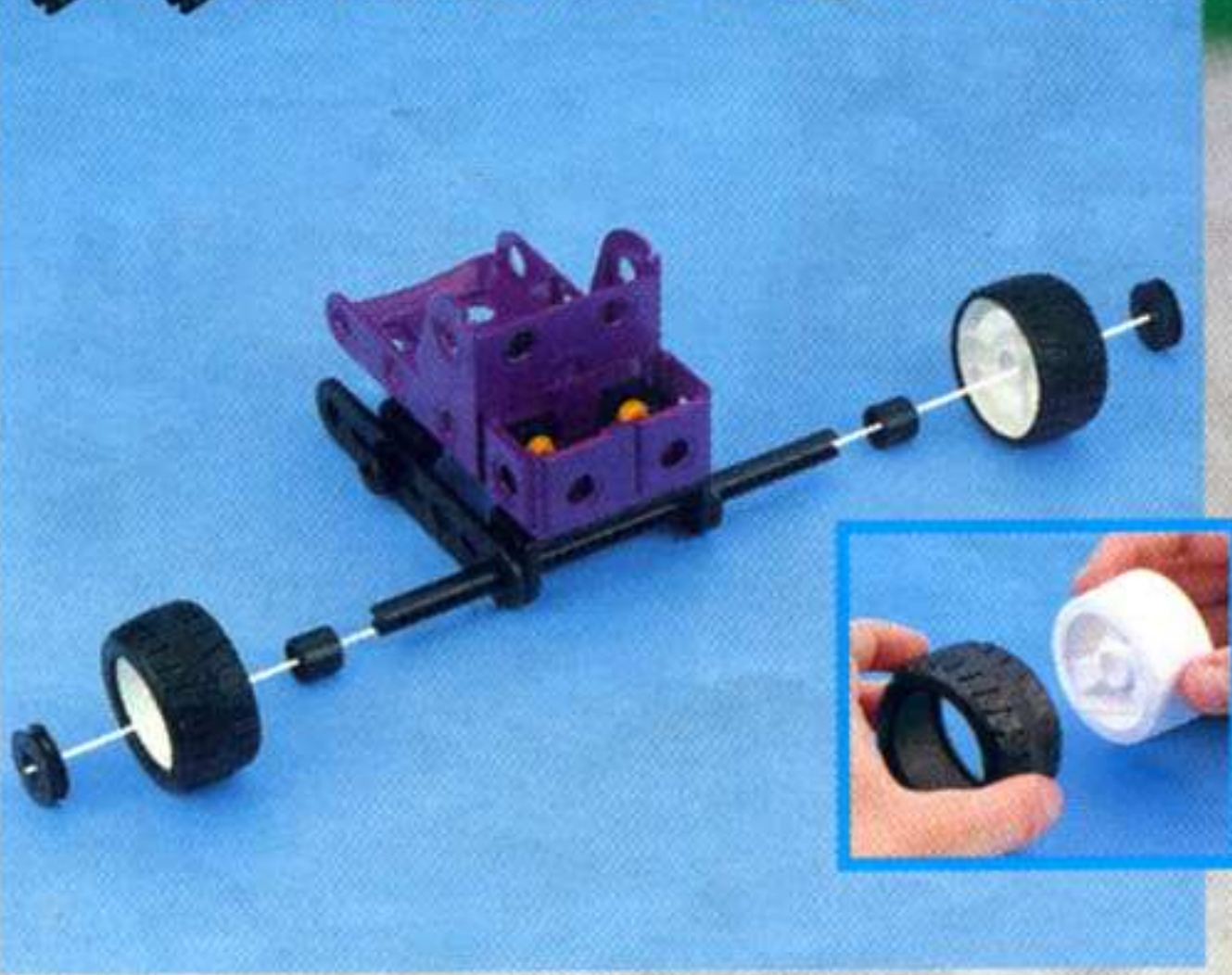

7

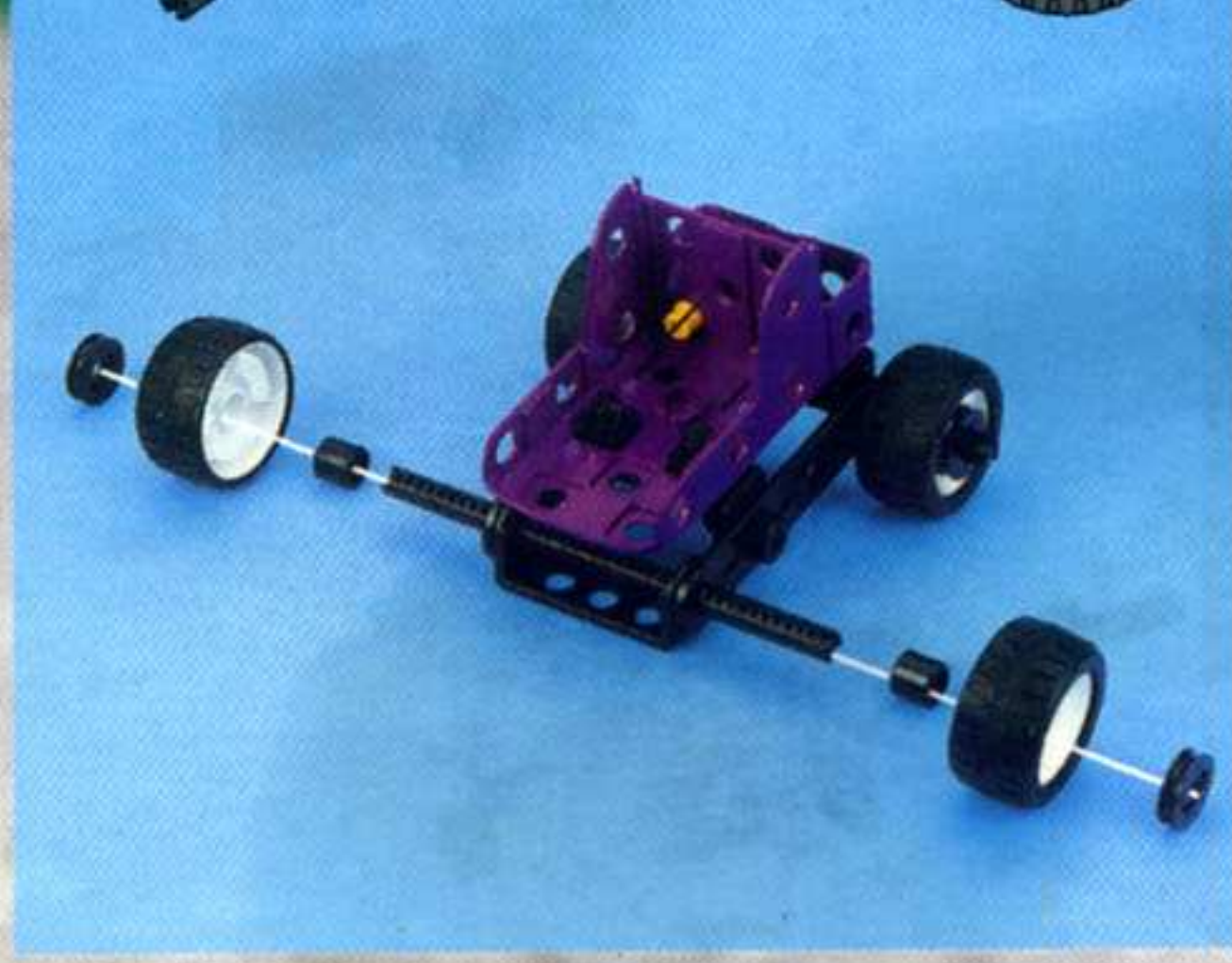

8



26



3

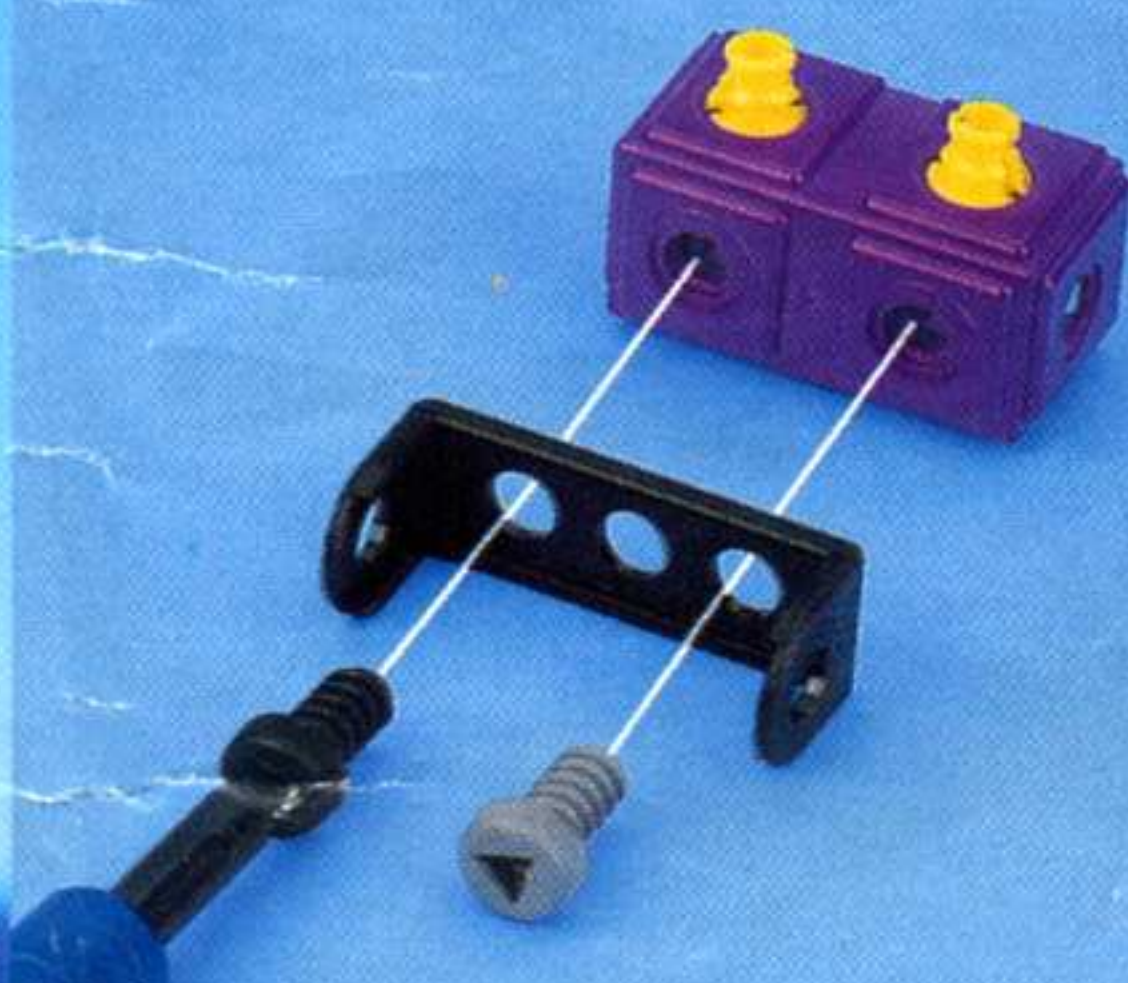

4

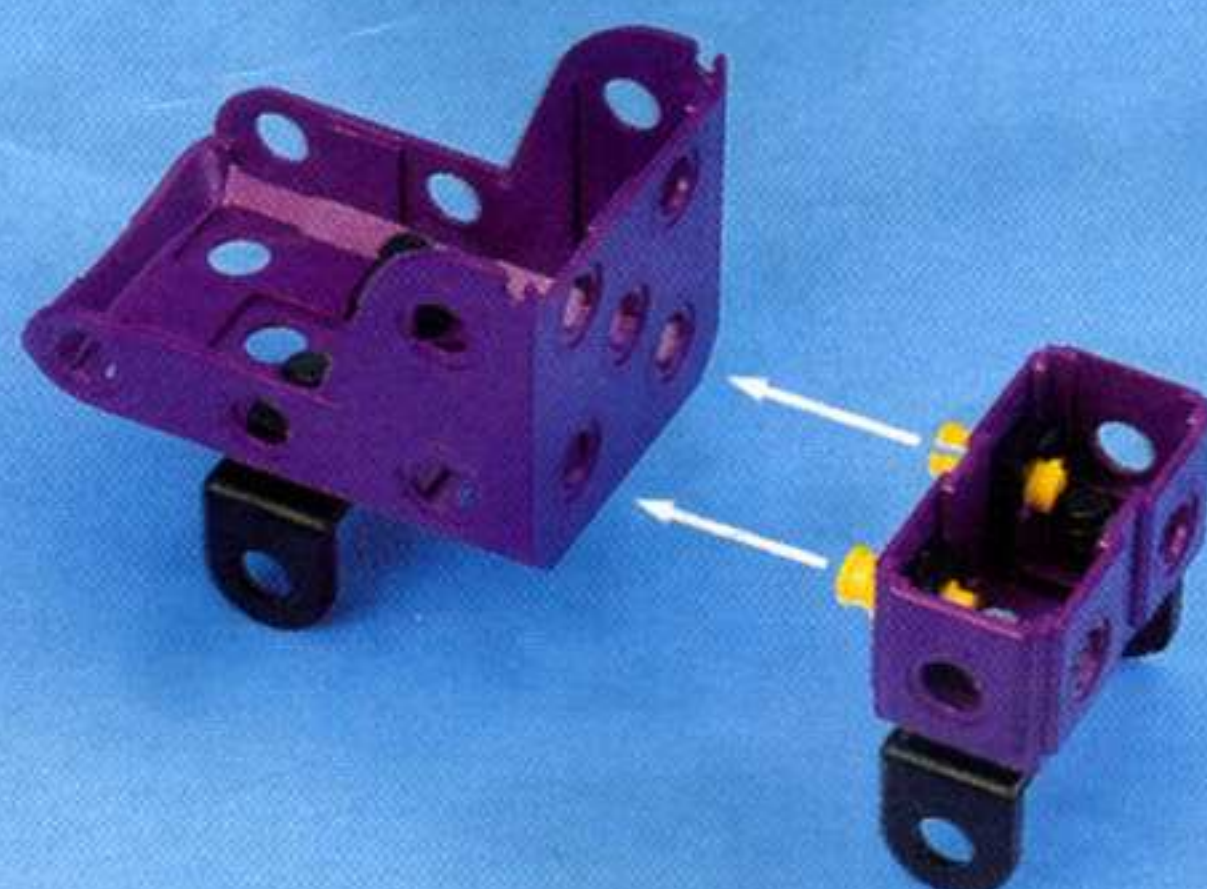

5

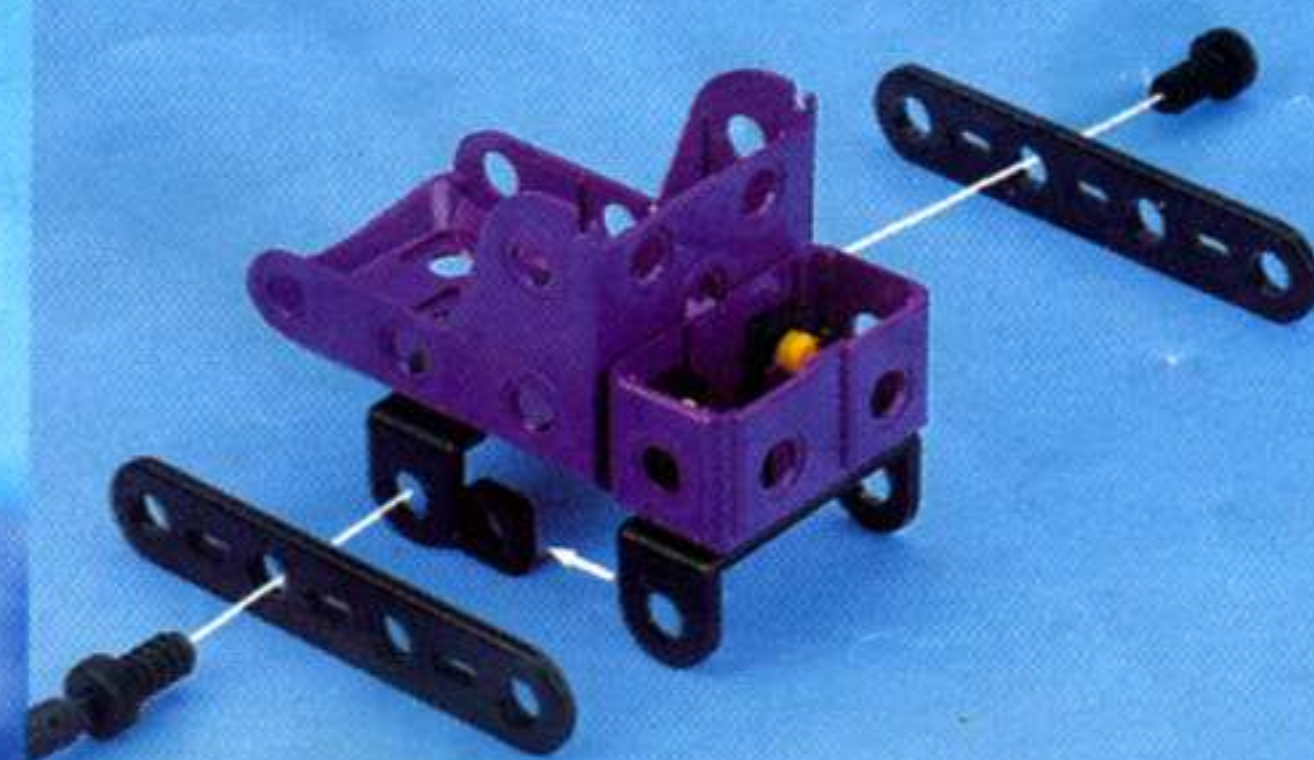

# CITY



**GB/USA** : Many of the models and component parts are unique and original designs which are the property of MECCANO S.A. They are protected by national legislation as industrial designs, trademarks and/or copyrights throughout many countries. For detailed information, please contact MECCANO S.A. Meccano S.A. shall have no responsibility for (I) failure to follow instructions, (II) use of parts for any purpose other than as specified in the instructions (III) any alteration of any parts or components. MECCANO S.A. respects children's safety: all models are tested by children.

**F** : De nombreux modèles et pièces sont des créations originales, propriétés de MECCANO S.A. et sont protégés par les législations nationales sur les dessins et modèles, marques et/ou droits d'auteurs. Pour toute information, merci de contacter : MECCANO S.A. La responsabilité de MECCANO S.A. ne saurait être engagée en cas d'accident survenu à la suite (I) du non respect des instructions de montage (II) d'une utilisation des pièces autre que celle proposée dans la notice (III) d'une altération ou de la modification des pièces. La société MECCANO respecte la sécurité des enfants : ses modèles sont testés par des enfants.

**D** : Zahlreiche Modelle und Teile sind Erfindungen und Eigentum der Firma MECCANO S.A. Sie sind durch Inland-Gesetze über Zeichnungen und Modelle sowie Warenzeichen und/oder Urheberrechte geschützt. Für zusätzliche Auskünfte wenden Sie sich bitte an : MECCANO S.A. Die Firma Meccano S.A. haftet nicht für Unfälle, die aus der (I) Nichteinhaltung der Bauanleitung, der (II) Verwendung anderer als in der Bauanleitung angegebenen Teile oder der (III) Änderung oder Modifikation der Teile resultieren. Alle Modelle der Firma Meccano S.A. wurden von Kindern getestet und entsprechen den Sicherheitsnormen.

**I** : Numerosi modelli e pezzi sono creazioni originali della MECCANO S.A. e sono protetti dalle legislazioni nazionali sui disegni e modelli, marche e/o diritti d'autore. Per qualsiasi informazione, vogliate prendere contatto con: MECCANO S.A. MECCANO S.A. declina ogni responsabilità in caso d'incidenti sopravvenuti in seguito (I) a: non rispetto delle istruzioni di montaggio (II) utilizzo dei pezzi per funzioni diverse da quelle previste nel manuale (III) alterazione e/o modifica dei pezzi. La società MECCANO rispetta la sicurezza dei bambini: i suoi modelli vengono testati dai bambini stessi.

**E** : Numerosos modelos y piezas son creaciones originales, propiedades de MECCANO S.A. y están protegidos por las legislaciones nacionales en lo que concierne a los dibujos y modelos, marcas y/o derechos de autor. Para cualquier información, sírvase ponerse en contacto con: MECCANO S.A. MECCANO S.A. carece de responsabilidad en caso de accidente debido a: (I) el incumplimiento de las instrucciones de montaje (II) una utilización de las piezas diferente a la que se indica en las instrucciones (III) una alteración o modificación de las piezas. La sociedad MECCANO respeta la seguridad de los niños: sus modelos están probados por niños.

**P** : Vários modelos e peças são criações originais, propriedades da MECCANO S.A. e são protegidos pelas legislações nacionais relativas aos desenhos e modelos, às marcas e/ou aos direitos de autor. Para qualquer informação, é favor contactar : MECCANO S.A. A Sociedade MECCANO S.A. não poderá ser responsabilizada pelos acidentes provocados: (I) pela falta de cumprimento das instruções de montagem (II) pelo uso indevido das peças ou (III) pela modificação ou alteração das peças. A Sociedade MECCANO respeita a segurança das crianças: os seus modelos foram testados por crianças.

**S** : Många modeller och delar bildar en unik och originell formgivning vilken är MECCANO S.A. egendom. Dessa modeller och delar är skyddade genom lagstiftning såsom industriell formgivning, varumärke och/eller upphovsmannarätt i ett flertal länder. För mer detaljerad information, var vänlig och kontakta MECCANO S.A. MECCANO S.A. frångår sig allt ansvar i händelse av olycka till följd av (I) att monteringsinstruktionerna inte har respekterats (II) en annan användning av delarna än den som står i anvisningen, (III) en förvanskning eller förändring av delarna. Företaget MECCANO respekterar barnsäkerheten: modellerna har testats av barn.

**FIN** : Vore mange modeller og dele er originale fremstillinger og ejes af MECCANO S.A. Tegninger, modeller, fabrikationsmærker og ophavsret er lovbeskyttede i hvert land. Yderligere oplysninger kan fås hos: MECCANO S.A. MECCANO S.A. ei vastaa ei kata seuraavista syistä sattuneita onnettomuuksia: (1) ohjeiden vastainen kokoaminen, (2) muiden kuin ohjeissa ehdotettujen osien käyttö, (3) osien vaihto tai muuttelu. MECCANO-yhtiö huolehtii lasten turvallisuudesta: lapset ovat testanneet mallimme.

**DK** : Useat mallit ja osat ovat MECCANO S.A.:n omaisuutta olevaa suunnittelua. Useat mallit ja niiden osat ovat lailla suojattua teollista tuotantoa, tavaramerkkejä ja/tai kopiointioikeuksia useissa maissa. Tuotemerkki MECCANO. Säferet der sker uheld forårsaget af (I) at monteringsinstruktionerne ikke er blevet overholdt, (II) at delene er blevet brugt til andre formål, end dem der er beskrevet i betjeningsvejledningen, (III) eller at delene er blevet beskadiget eller ændret, frasiger MECCANO S.A. sig ethvert ansvar for dette. MECCANO overholder sikkerhedsreglerne for børn: alle modeller testes af børn.

**NL** : Veei modellen en onderdelen zijn originele ontwerpen en eigendom van MECCANO S.A. en worden beschermd door de nationale wetgevingen op tekening en modellen, merken en/of auteursrechten. Voor informatie gelieve contact op te nemen met MECCANO S.A. De verantwoordelijkheid van MECCANO S.A. is uitgesloten in geval van ongevalen voortvloeiend uit het niet naleven van de montage-instructies (I), uit het gebruik van andere onderdelen dan die zoals vermeld in de handleiding (II) of uit het veranderen of modificeren van de onderdelen (III). De firma MECCANO neemt de veiligheid van de kinderen in acht: de modellen zijn door kinderen getest.

**GR** : Πολλά μοντέλα και ανταλλακτικά είναι αυθεντικά, ιδιοκτησία της MECCANO S.A. και προστατεύονται από τις εθνικές νομοθεσίες για τα μοντέλα τις μάρκες ή τα δηλώματα ευρεσιτεχνίας. Τα κάθε πληροφορία παρακαλώ απευθυνθείτε στη MECCANO S.A. Η ευθύνη της MECCANO S.A. δεν δεσμεύεται σε περίπτωση ατυχήματος που έγινε συνέχεια (I) μη ασφάλισμου των οδηγών, αντιστοίχισης (II) χρήσης των τεμαχίων διαφορετική από αυτή που προτείνεται στις οδηγίες (III) καταστροφή ή αλλαγή των τεμαχίων. Η εταιρεία MECCANO αξιολογεί την ασφάλεια των παιδιών: τα μοντέλα της δοκιμάζονται από παιδιά.

**JPN** : モデルならびに部品は、その多くが MECCANO 社所有のオリジナル・デザインで、名称・商標および/または著作権に関する国内法によって保護されています。詳細については、当社 (MECCANO S.A.) メカノ社は (I) 組立の注意事項を守らなかった場合、(II) 使用説明書に記載されたもの以外の部品を使用した場合、(III) 部品を改造・改造した場合などに起きた事故については責任を負うことはできません。メカノ社の全モデルは事前に子供たちによりテストを行い、その安全性を確認されております。



## MECCANO

© 04/1999 MECCANO S.A.

MECCANO®, MECCANO JUNIOR®, MECCANO PLAY SYSTEM® and ERECTOR PLAY SYSTEM™ are exclusive trademarks of MECCANO S.A.

Made in France by / Fabriqué en France par / Hecho en Francia : MECCANO S.A.  
363, avenue de Saint Exupéry - F - 62100 CALAIS