



WARNING : CHOKING HAZARD
Small parts. Not for children under 3 years.



#7102

5-8

CITY

www.meccano.com



p.6



p.12



p.14



p.18



CONSTRUCTION TIPS

LES ASTUCES DE CONSTRUCTION
 KONSTRUKTIONSTIPPS
 LE ASTUZIE DELLA COSTRUZIONE
 LOS INGENIOS DE LA CONSTRUCCIÓN
 DICAS PARA A MONTAGEM
 KOKKONPANON KIKAT
 BYGGKNEPEN
 ET PAR TIPS TIL BYGGARBEJDET
 DE FIJNE KNEEPJES VAN NET BOUWEN
 Το ΕΞΙΤΗΝΑ ΚΟΛΠΑ ΚΑΤΑΣΚΕΥΗΣ
 組み立ての秘訣

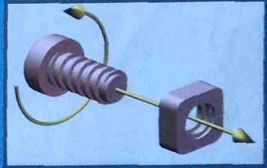

- (GB) With Meccano and Erector, your child will not only design things and exercise his imagination, he will also learn to build and improve his hand-eye co-ordination while using a screwdriver.
- (F) Avec Meccano, votre enfant ne va pas seulement créer et exercer son imagination, il va aussi apprendre à construire et affiner sa grapho-motricité en vissant.
- (D) Mit Meccano entwickelt ihr Kind spielend Phantasie und Kreativität. Es lernt, Modelle zu konstruieren und bildet beim schrauben seine Feinmotorik aus.
- (I) Con Meccano il vostro bambino non solo creerà, esercitando la propria immaginazione, ma imparerà anche a costruire e ad affinare la sua grafico-motricità avvitando.
- (E) Con Meccano, su hijo no sólo creará y utilizará su imaginación, sino que además aprenderá a construir y afinará su grafico-motricidad atornillando.
- (P) Aparatusando com Meccano, o criança não só vai criar e desenvolver a sua imaginação, como também vai aprender a formar e apertar a sua grafomotricidade.
- (S) Med Meccano får ditt barn lite bære utløpp for sin fantasi og skapelsest, men kommer dessutom att lære sig ett bygge samt tråna sin skrivmotorik genom att skruva.
- (FIN) Meccano avulla lapsi ei ainoastaan luo uuttia ja käyttää mielikuvitustaan, hän oppii samalla myös asia yhteen liittäessään kehittämään ja hiomaan käsiensä liikkeenhallintaa.
- (DNK) Med Meccano vil dit barn ikke kun øve sin kreativitet og fantasi, men også lære at bygge og forbedre motorik og skrivemotor ved at skruve.
- (NL) Uw kind zal met Meccano niet alleen zijn fantasie creëren en gebruiken, hij zal ook leren al bouwend zijn fijne motoriek en behendigheid te ontwikkelen.
- (GR) Με τη Meccano το παιδί σας δεν δημιουργεί και εδράζει τη φαντασία του, αλλά και να εκπαιδεύεται την κινητικότητα γραφικής του.
- (JPN) 本力はお子様の想像力を養うばかりか、組み立てに伴い視覚運動能力を発達させます。



CITY

FEATURES

LES ASTUCES DE JEUX
FUNKTIONEN
STRATEGIA DI GIOCO
TRUCOS DE LOS JUEGOS
COM DICAS

FINURLIGT
PELIIN SISÄLTYVÄT KIKAT
TIPS
HANDIGE TIPS
ΚΑΛΑ ΠΑΙΧΝΙΔΙΟΥ
遊び方の例



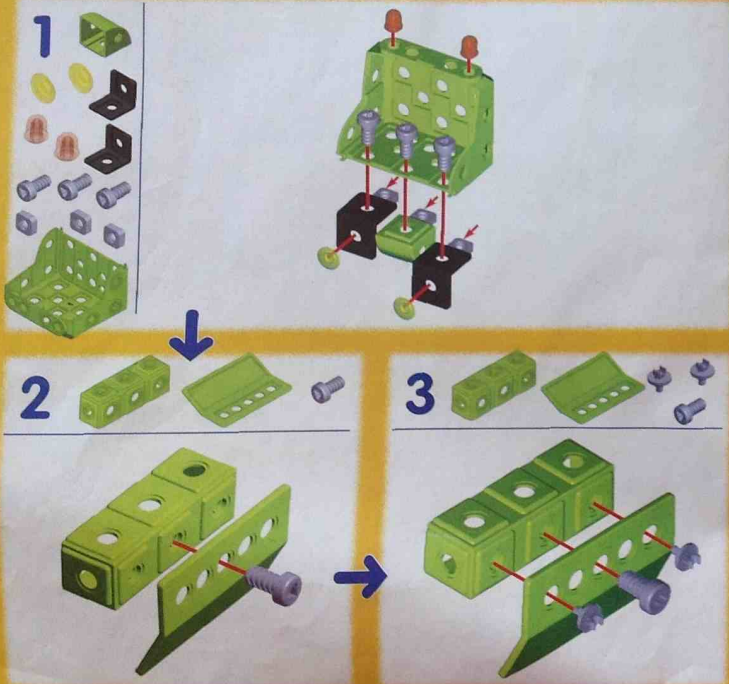

6

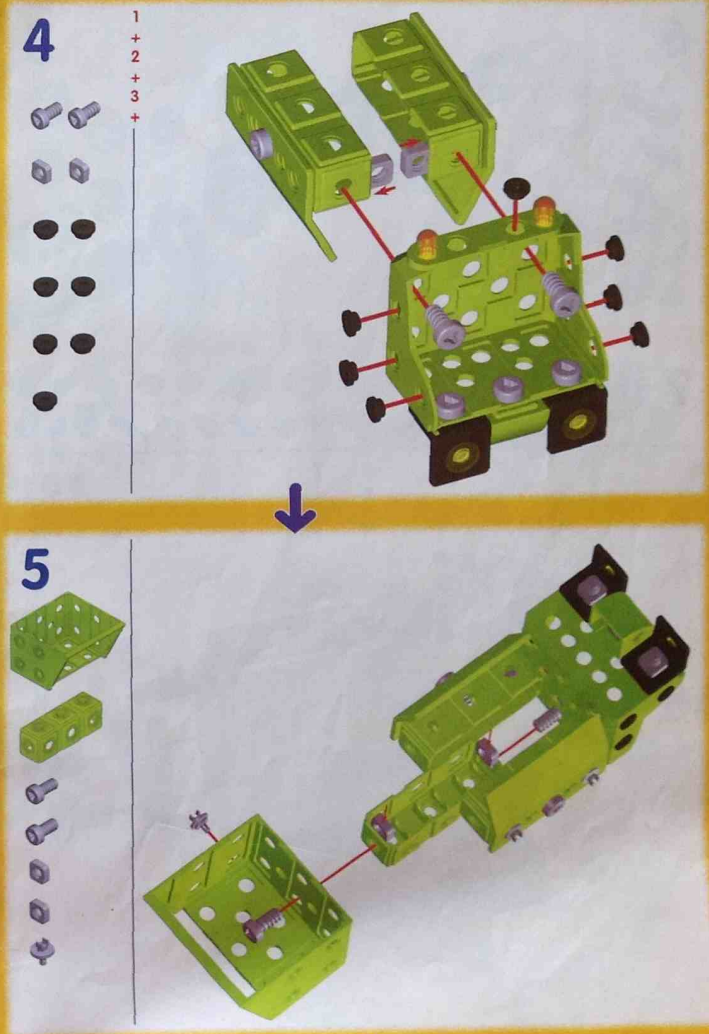

7

6

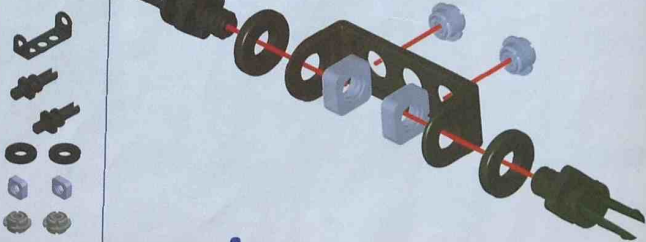

7

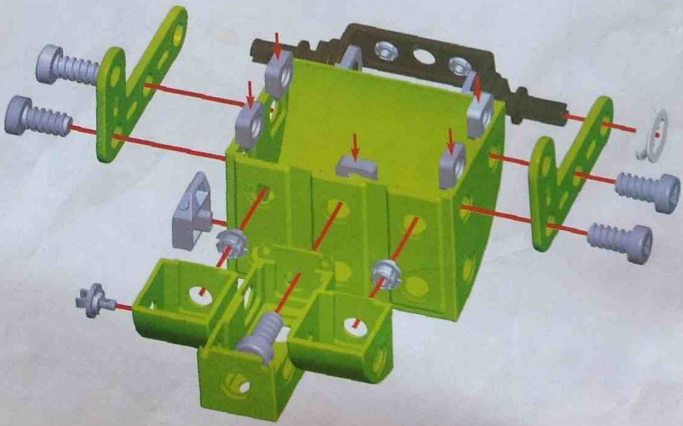
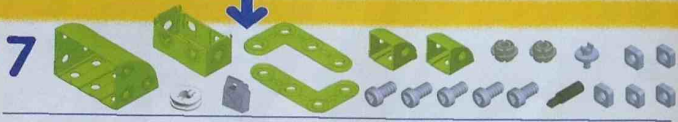

8

8

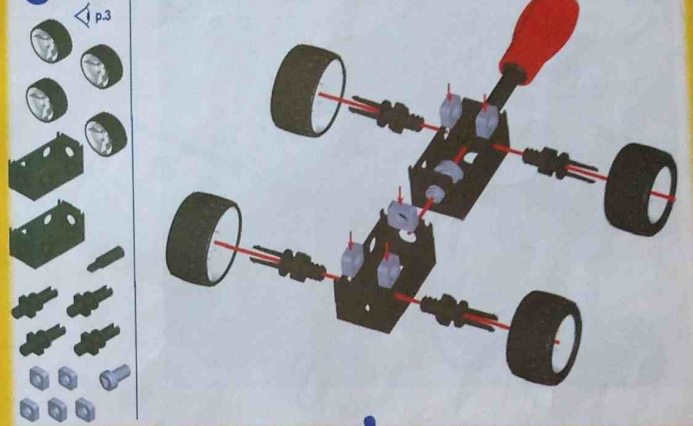

9



9

10

5 + 9 +

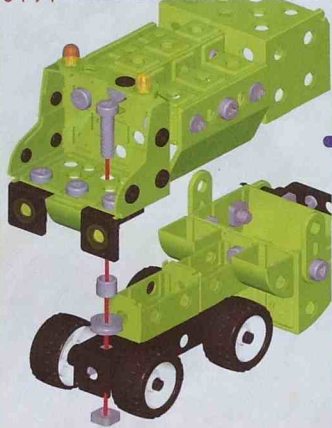

11

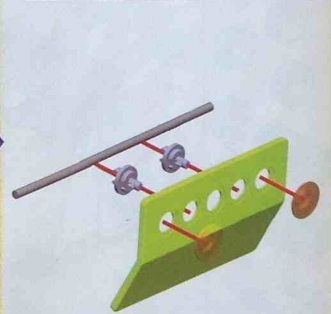

12

10 + 11 +

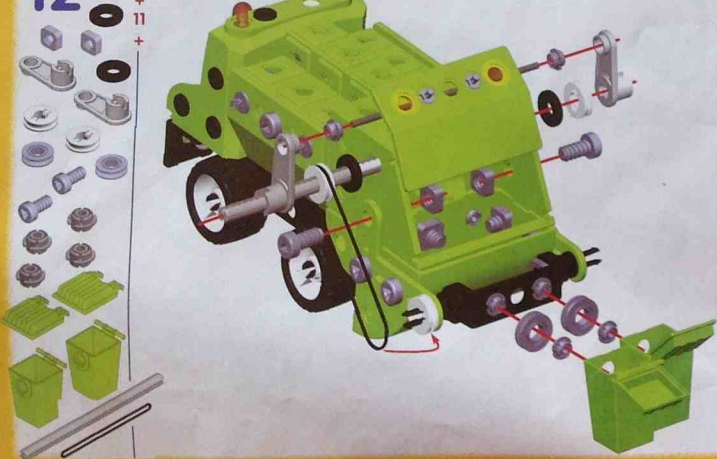

10

13

p.3

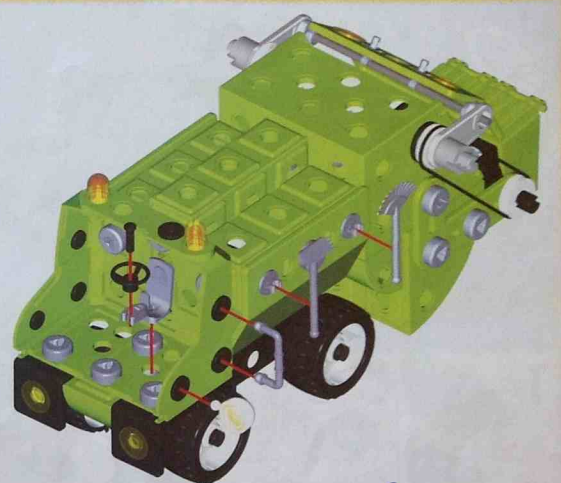

14



11

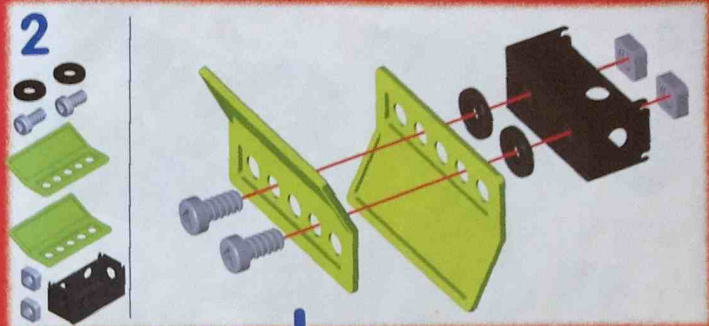
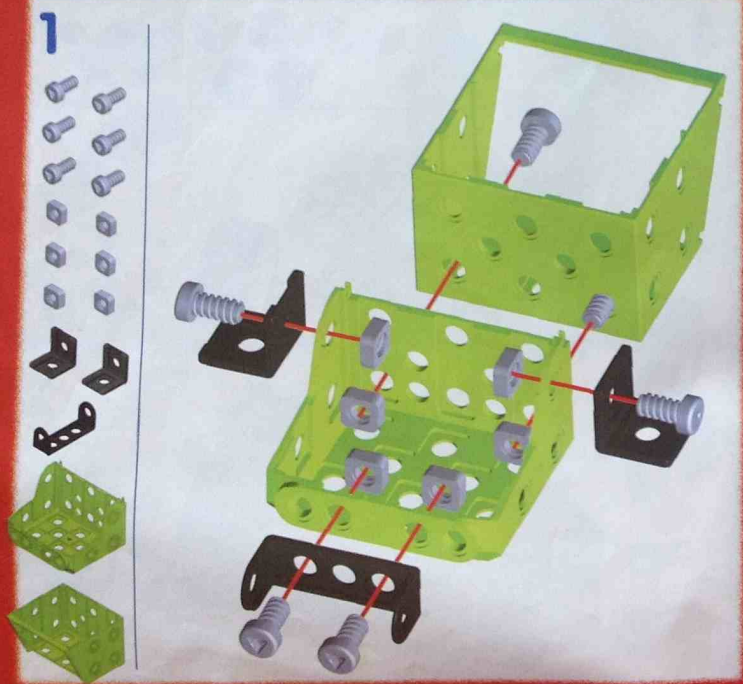

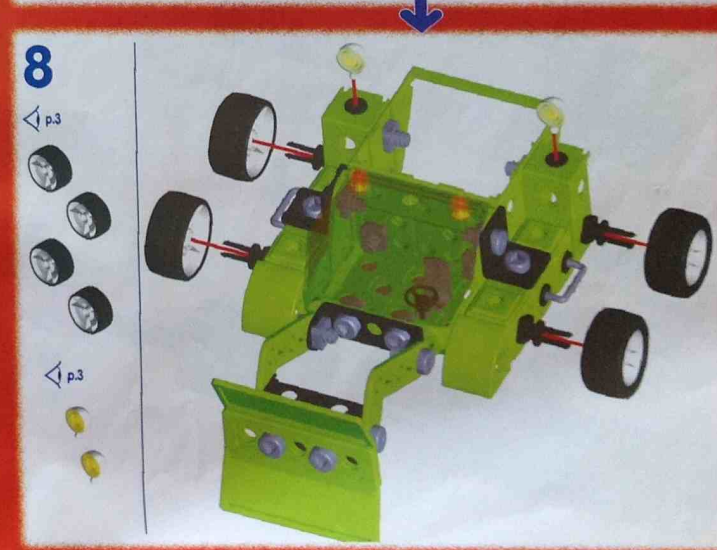
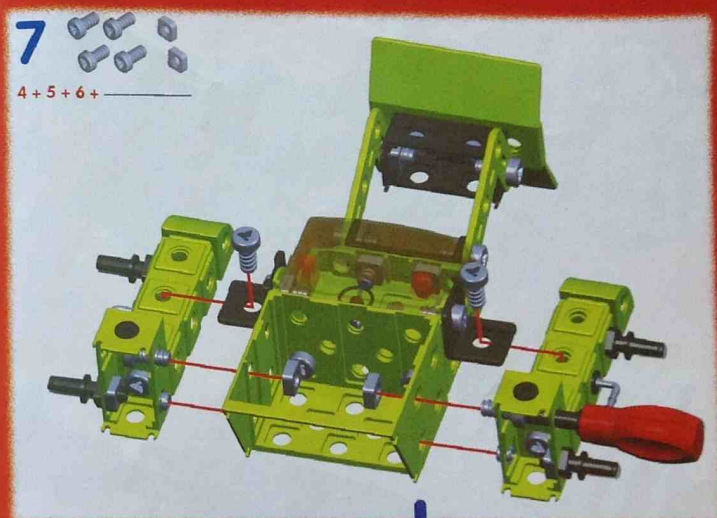
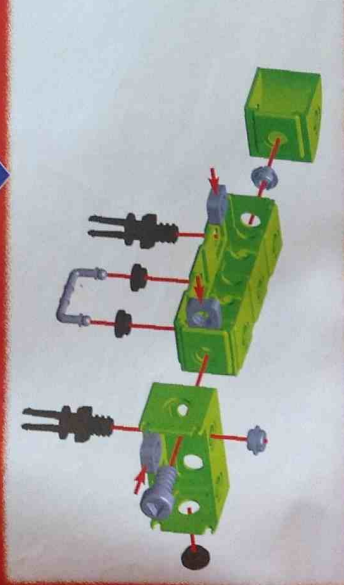
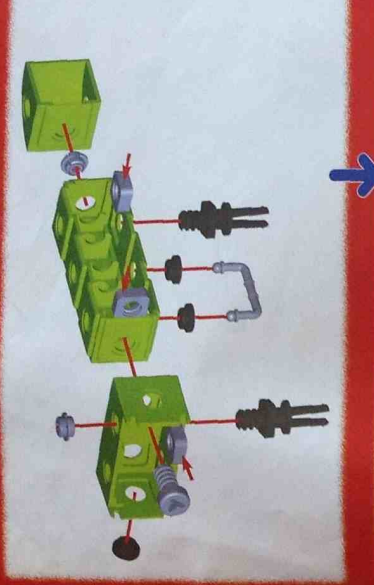

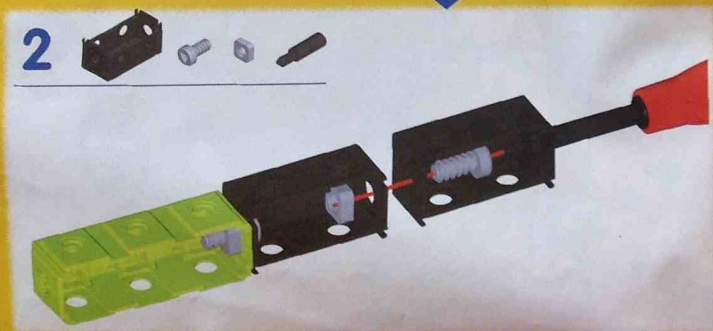
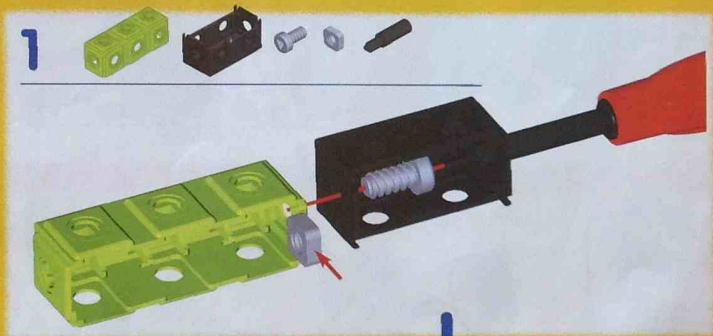
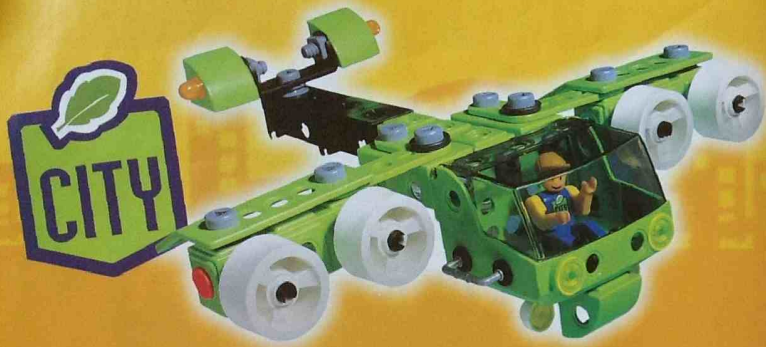

18

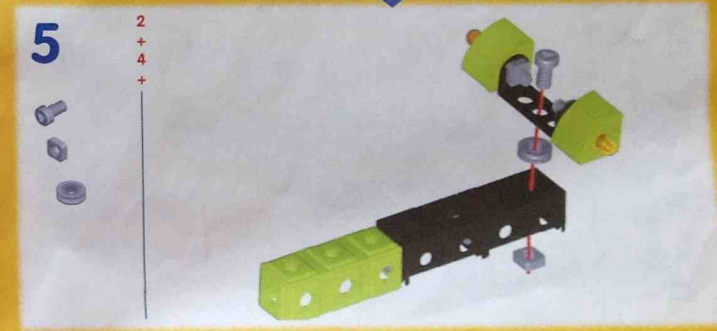
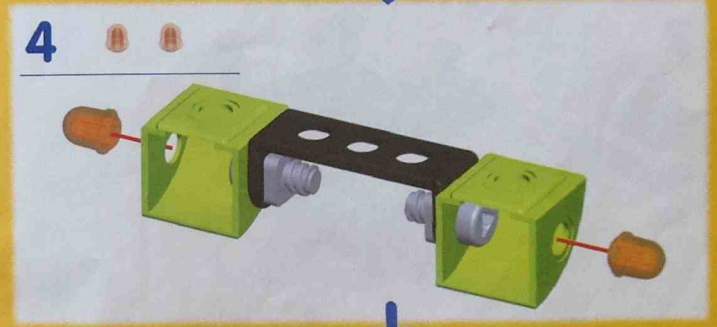
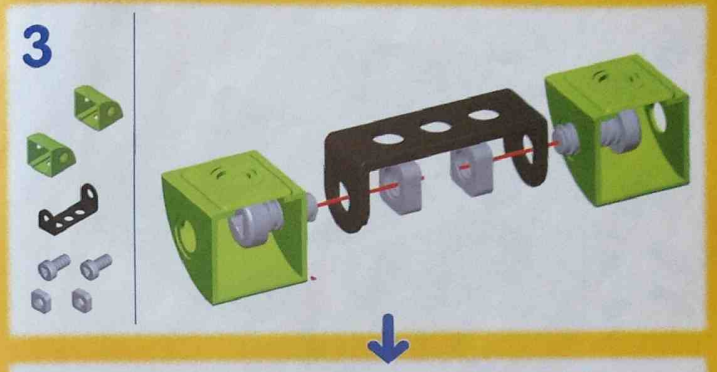

19

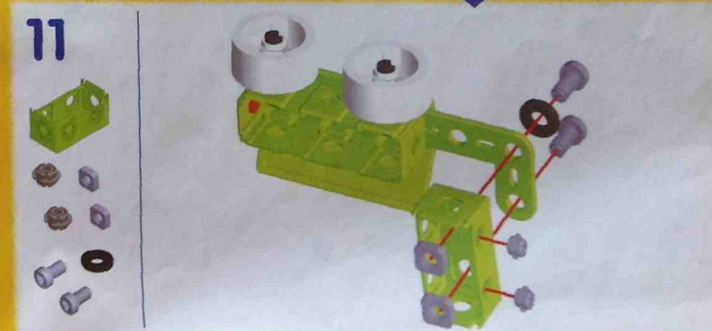
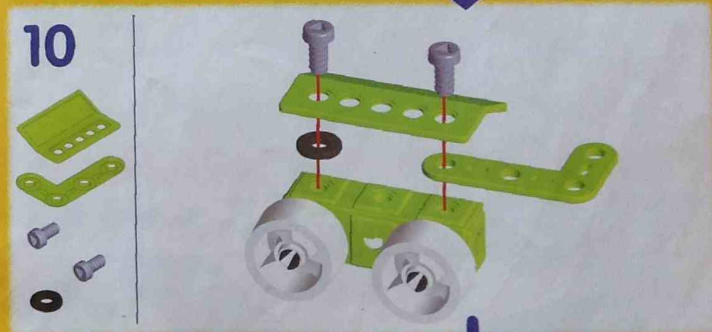
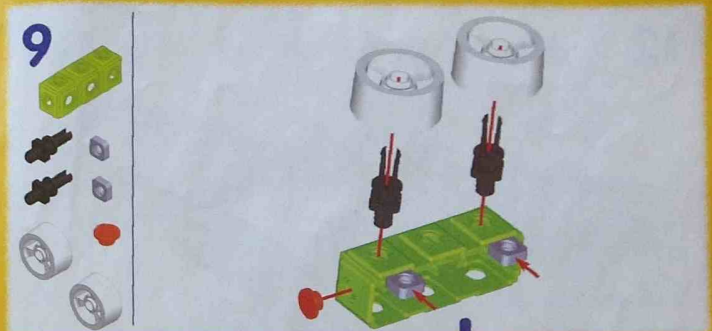
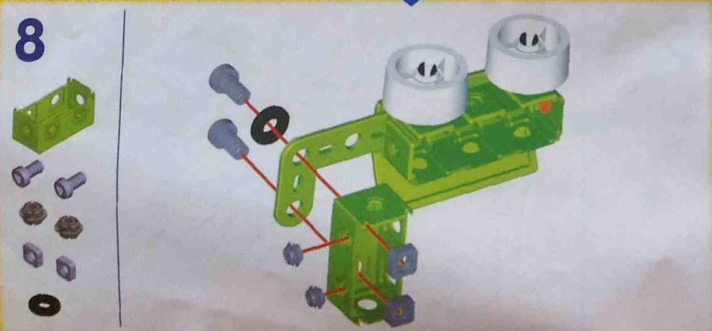
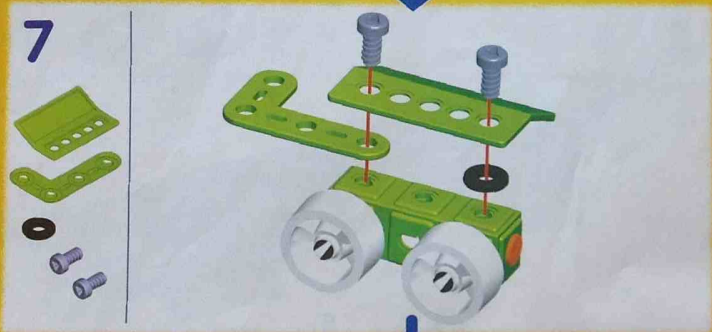
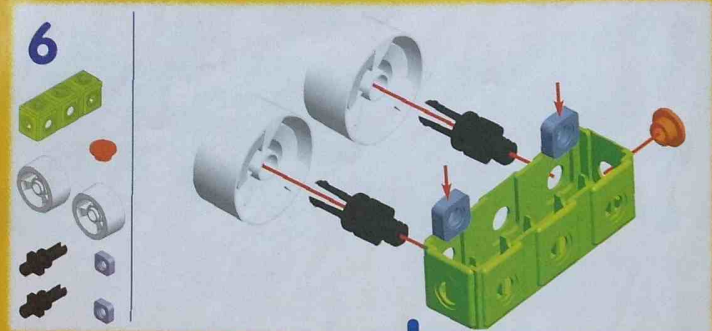

12

5 + 8 + 11 +

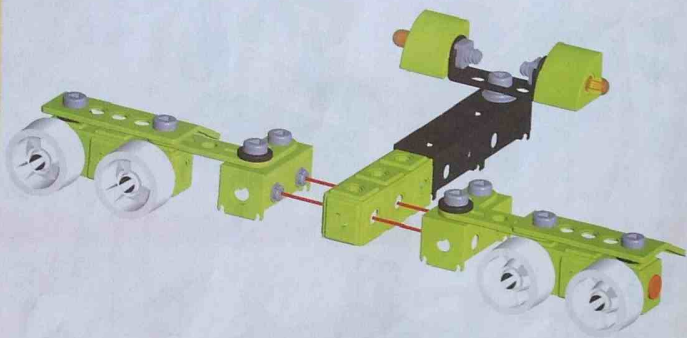

13

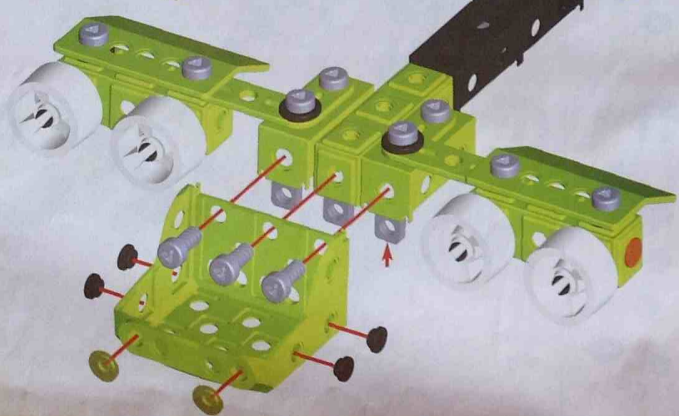

22

14

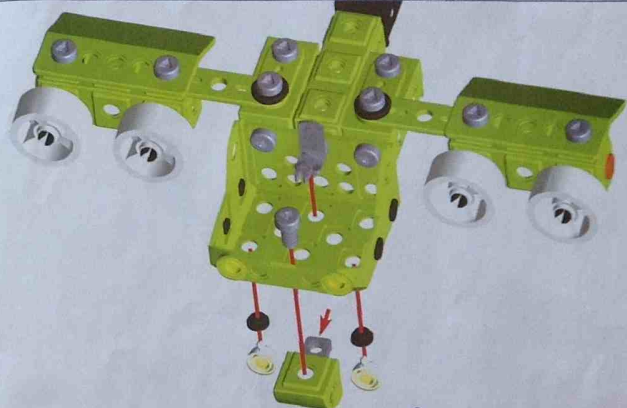

15

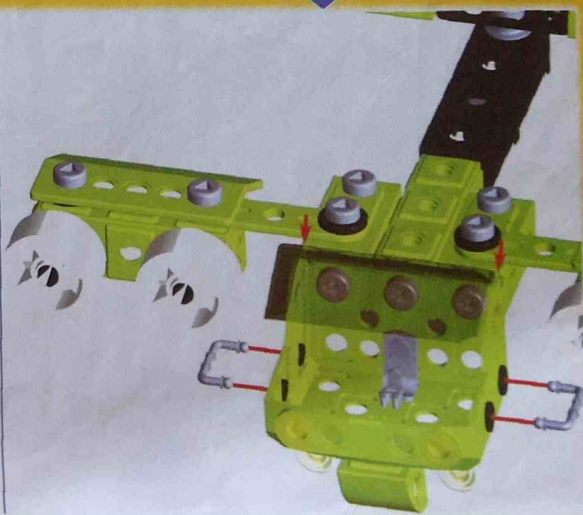

23

GB USA Many of the models and component parts are unique and original designs which are the property of MECCANO S.N. They are protected by national legislation as industrial designs, trademarks and/or copyrights throughout many countries. For detailed information, please contact: MECCANO S.N. Meccano S.N. shall have no responsibility for (I) failure to follow instructions, (II) use of parts for any purpose other than as specified in the instructions (III) any alteration of any parts or components. MECCANO S.N. respects children's safety: all models are tested by children.

F De nombreux modèles et pièces sont des créations originales, propriétés de MECCANO S.N. et sont protégés par les législations nationales sur les dessins et modèles, marques et/ou droits d'auteurs. Pour toute information, merci de contacter : MECCANO S.N. La responsabilité de MECCANO S.N. ne saurait être engagée en cas d'accident survenu à la suite (I) du non respect des instructions de montage (II) d'une utilisation des pièces autre que celle proposée dans la notice (III) d'une altération ou de la modification des pièces. La société MECCANO respecte la sécurité des enfants : ses modèles sont testés par des enfants.

D Zahlreiche Modelle und Teile sind Erfindungen und Eigentum der Firma MECCANO S.N. Sie sind durch Inland-Gesetze über Zeichnungen und Modelle sowie Warenzeichen und/oder Urheberrechte geschützt. Für zusätzliche Auskünfte wenden Sie sich bitte an : MECCANO S.N. Die Firma Meccano S.N. haftet nicht für Unfälle, die aus der (I) Nichteinhaltung der Bauanleitung, der (II) Verwendung anderer als in der Bauanleitung angegebenen Teile oder der (III) Änderung oder Modifikation der Teile resultieren. Alle Modelle der Firma Meccano wurden von Kindern getestet und entsprechen den Sicherheitsnormen.

I Numerosi modelli e pezzi sono creazioni originali della MECCANO S.N. e sono protetti dalle legislazioni nazionali sui disegni e modelli, marche e/o diritti d'autore. Per qualsiasi informazione, vogliate prendere contatto con : MECCANO S.N. Meccano S.N. declina ogni responsabilità in caso d'incidenti sopravvenuti in seguito (I) a non rispetto delle istruzioni di montaggio (II) utilizzo dei pezzi per funzioni diverse da quelle previste nel manuale (III) alterazione e/o modifica dei pezzi. La società MECCANO rispetta la sicurezza dei bambini : i suoi modelli vengono testati dai bambini stessi.

E Numerosos modelos y piezas son creaciones originales, propiedades de MECCANO S.N. y están protegidos por las legislaciones nacionales en lo que concierne a los dibujos y modelos, marcas y/o derechos de autor. Para cualquier información, sírvase ponerse en contacto con : MECCANO S.N. MECCANO S.N. carece de responsabilidad en caso de accidente debido a: (I) el incumplimiento de las instrucciones de montaje (II) una utilización de las piezas diferente a la que se indica en las instrucciones (III) una alteración o modificación de las piezas. La sociedad MECCANO respeta la seguridad de los niños : sus modelos están probados por niños.

P Vários modelos e peças são criações originais, propriedades da MECCANO S.N. e são protegidos pelas legislações nacionais relativas aos desenhos e modelos, às marcas e/ou aos direitos de autor. Para qualquer informação, é favor contactar : MECCANO S.N. A Sociedade MECCANO S.N. não poderá ser responsabilizada pelos acidentes provocados: (I) pelo falta de cumprimento das instruções de montagem (II) pelo uso indevido das peças ou (III) pela modificação ou alteração das peças. A Sociedade MECCANO respeita a segurança das crianças : os seus modelos foram testados por crianças.

S Många modeller och delar bildar en unik och originell formgivning vilken är MECCANO S.N. egendom. Dessa modeller och delar är skyddade genom lagstiftning såsom industriell formgivning, varumärke och/eller upphovsmanrätt i ett flertal länder. För mer detaljerad information, var vänlig och kontakta MECCANO S.N. MECCANO S.N. fräntar sig ditt ansvar i händelse av olycka till följd av (I) att monteringsinstruktionerna inte har respekterats (II) en annan användning av delarna än den som står i anvisningen (III) en förvänskning eller förändring av delarna. Företaget MECCANO respekterar barnsäkerheten : modellerna har testats av barn.

FIN Useat mallit ja osat ovat MECCANO S.N.:n omaisuutta olevaa alkuperäistä suunnittelua. Ne ovat kansallisilla lailla suojattua teollista muotoilua, tavaramerkkejä ja/tai kopiointioikeuksia. Pyydämme ottamaan yhteyden MECCANO S.N.:han kaikissa asiassa liittyvissä kysymyksissä. MECCANO S.N. ei vastaa eikä kata seuraavista syistä sattuneita onnettomuuksia: (I) ohjeiden vastainen kokoaminen, (II) muiden kuin ohjeissa ehdotettujen osien käyttö, (III) osien muuntelu tai eri tarkoitukseen käyttö. MECCANO-yhtiö huolehtii lasten turvallisuudesta: lapset ovat testanneet mallimme.

DK Vore mange modeller og dele er originale fremstillinger og ejes af MECCANO S.N. Tegninger, modeller, fabrikmærker og ophavsret er lovbeskyttede i hvert land. Yderligere oplysninger kan fås hos: MECCANO S.N. MECCANO S.N. frasiger sig ethvert ansvar, såfremt der er sket uheld forårsaget af (I) at monteringsinstruktionerne ikke er blevet overholdt, (II) at delene er blevet brugt til andre formål, end dem der er beskrevet i betjeningsvejledningen, (III) eller at delene er blevet beskadiget eller ændret. MECCANO overholder sikkerhedsreglerne for børn: Alle modeller testes af børn.

NL Veel modellen en onderdelen zijn originele ontwerpen en eigendom van MECCANO S.N. en worden beschermd door de nationale wetgeving op tekeningen en modellen, merken en/of auteursrechten. Voor informatie gelieve contact op te nemen met MECCANO S.N. De verantwoordelijkheid van MECCANO S.N. is uitgesloten in geval van ongevallen voortvloeiend uit het niet naleven van de montage-instructies (I), uit het gebruik van andere onderdelen dan die zoals vermeld in de handleiding (II) of uit het veranderen of modificeren van de onderdelen (III). De firma MECCANO neemt de veiligheid van de kinderen in acht : de modellen zijn door kinderen getest.

GR Πολλά μοντέλα και ανταλλακτικά είναι αυθεντικά, ιδιοκτησία της MECCANO S.N. και προστατεύονται από τις εθνικές νομοθεσίες για τα μοντέλα της μόδας (I) τα διπλώματα ευρεσιτεχνίας (για κάθε πληροφορία παρακαλώ απευθυνθείτε στη MECCANO S.N.). Η εταιρεία της MECCANO S.N. δεν δεσμεύεται σε περίπτωση ατυχήματος που έγινε αληθινό (II) μη σφάλμα των οδηγών συναρμολόγησης (III) χρήσης των τεμαχίων διαφορετικά από αυτήν που προτείνεται στις οδηγίες (III) καταστροφή ή αλλαγή των τεμαχίων. Η εταιρεία MECCANO σεβεται την ασφάλεια των παιδιών: τα μοντέλα της δοκιμάζονται από παιδιά.

SPN 本廠所製之模型及零件均係 MECCANO 公司之原創設計，受各國法律之保護。欲知詳細資料，請向 MECCANO S.N. 查詢。本公司不負責任因 (I) 未遵照說明書之指示組裝，(II) 將零件用於說明書中未指定之用途，或 (III) 零件之損壞或修改所引起之意外。本公司之模型均經兒童測試，以確保其安全性。

Made in France by/Fabrique en France par/Hecho en Francia

MECCANO

© 03/2001 MECCANO S.N. 363, avenue de Saint Eupéry - F 62100 CALAIS
© MECCANO and ERECTOR are exclusive trademarks of MECCANO S.N.
Consumer Service/Service Consommateurs/Verbraucher Service:
<http://www.meccano.com>