



**WARNING : CHOKING HAZARD**  
Small parts. Not for children under 3 years.



#9101

5-8

CITY



p.6



p.7



p.4

p.10



p.13



p.16



p.18



p.20



p.22

## CONSTRUCTION TIPS

LES ASTUCES DE CONSTRUCTION  
 KONSTRUKTIONS-TIPPS  
 LE ASTUZIE DELLA COSTRUZIONE  
 LOS INGENIOS DE LA CONSTRUCCIÓN  
 DICAS PARA A MONTAGEM  
 KOKOONPANON KIKAT  
 BYGGKNEPEN  
 ET PAR TIPS TIL BYGGARBEJDET  
 DE FIJNE KNEEPJES VAN NET BOUWEN  
 Τα έξυπνα κόλπο κατασκευής  
 組み立ての秘訣

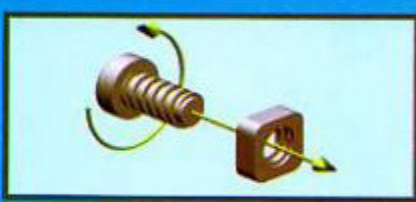

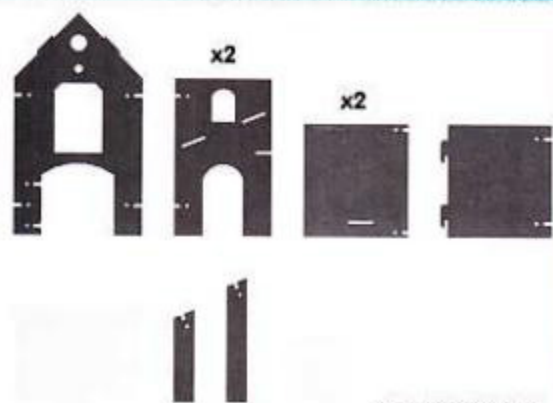
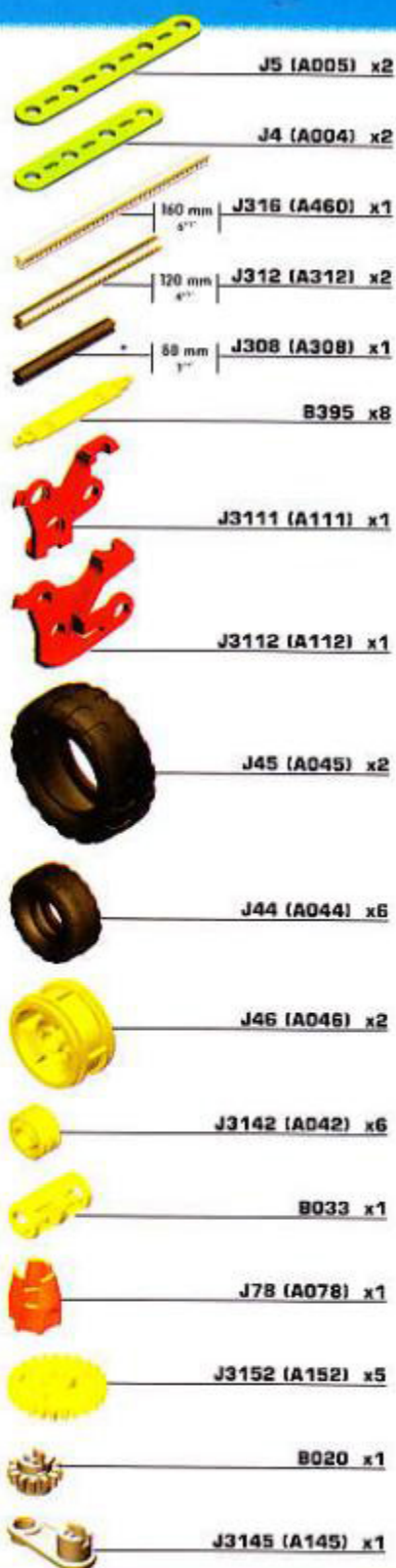
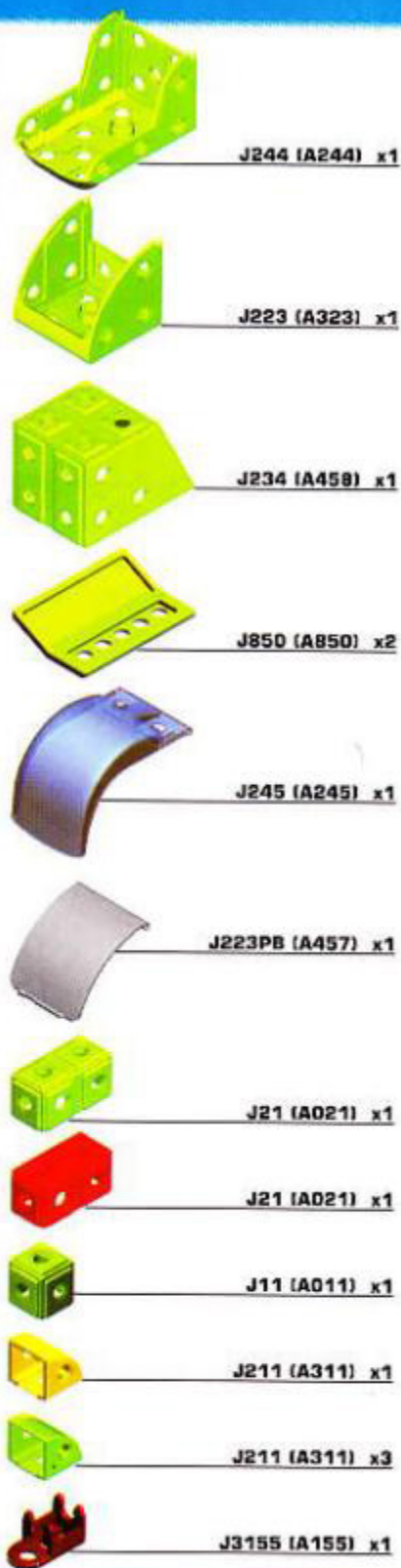

22B443000500



x2

223933177002

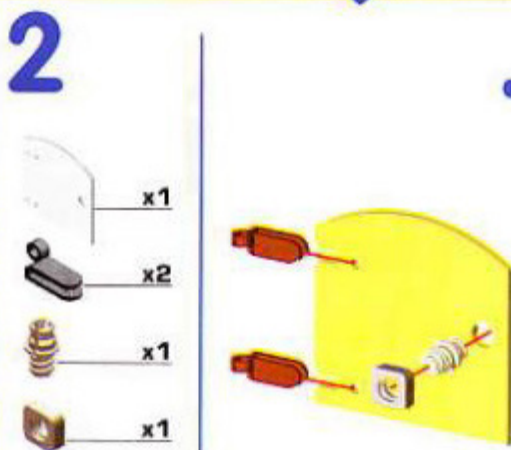
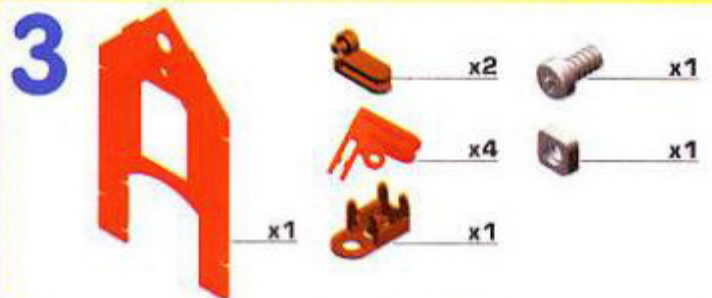

4

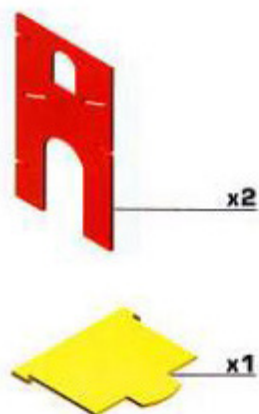

5

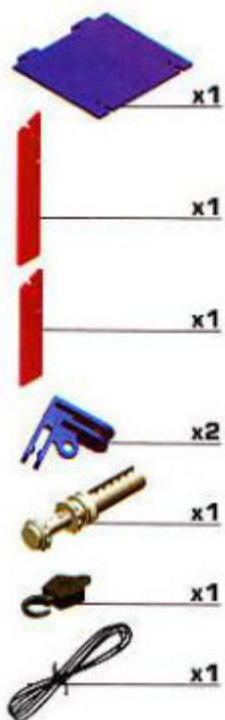

①  
+  
②  
+  
④  
+



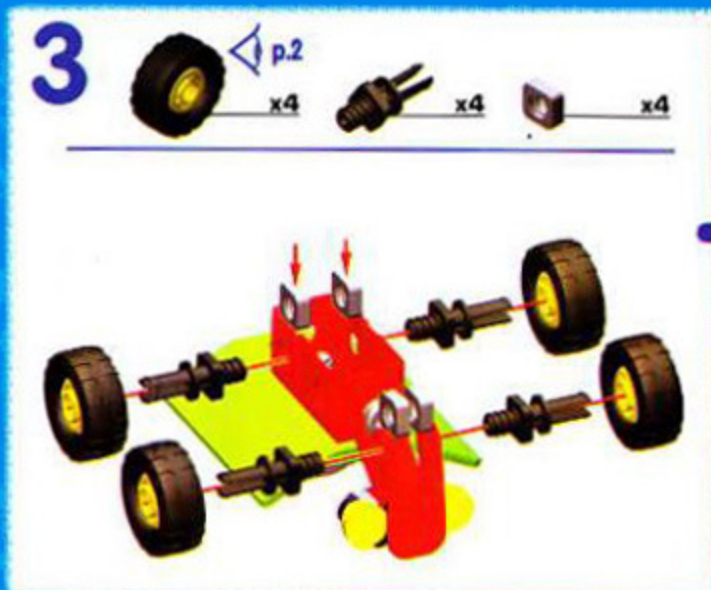
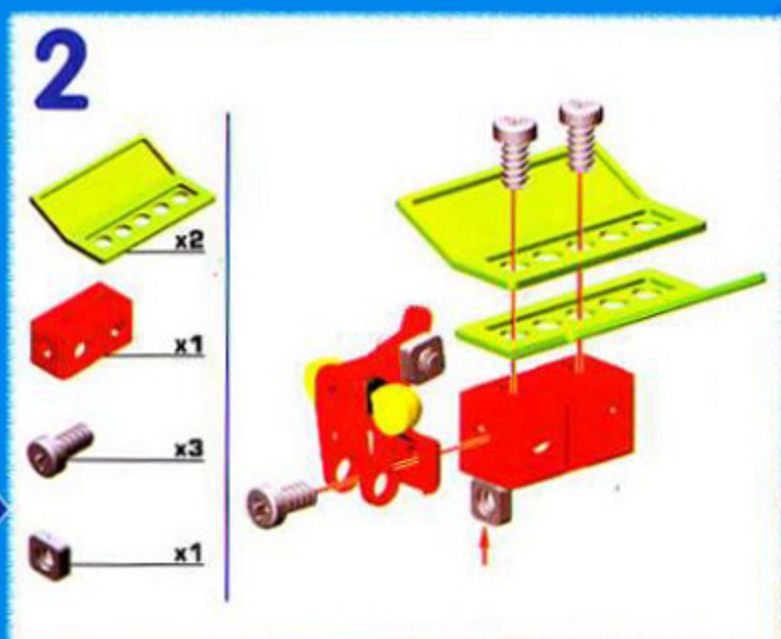

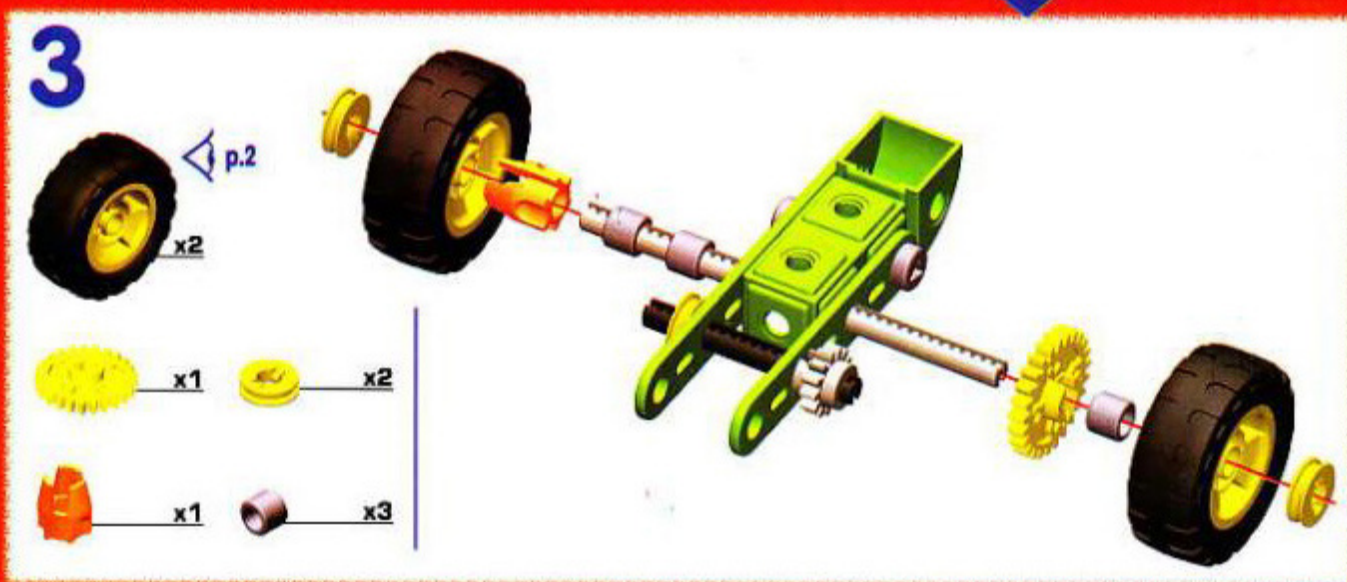
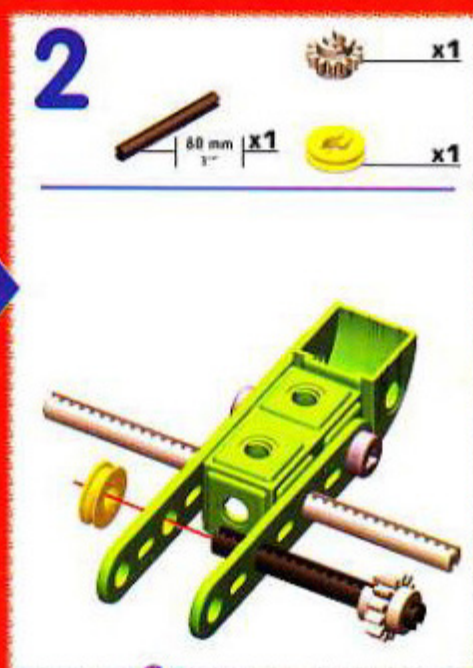
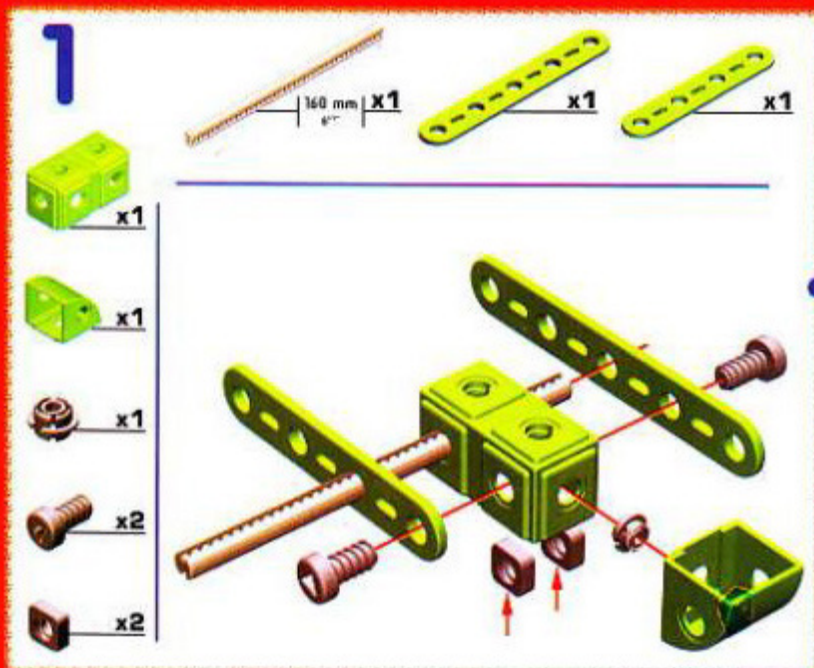

# 4



# 5

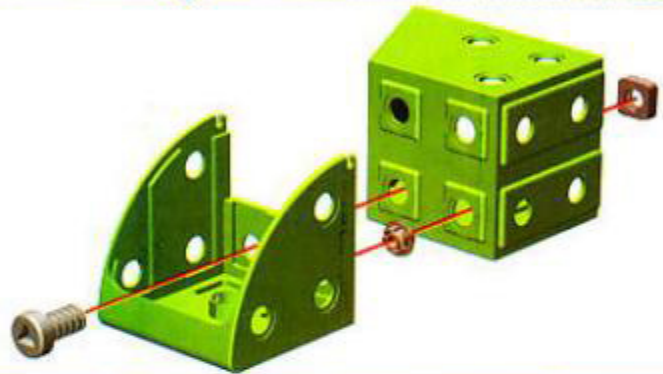

# 6

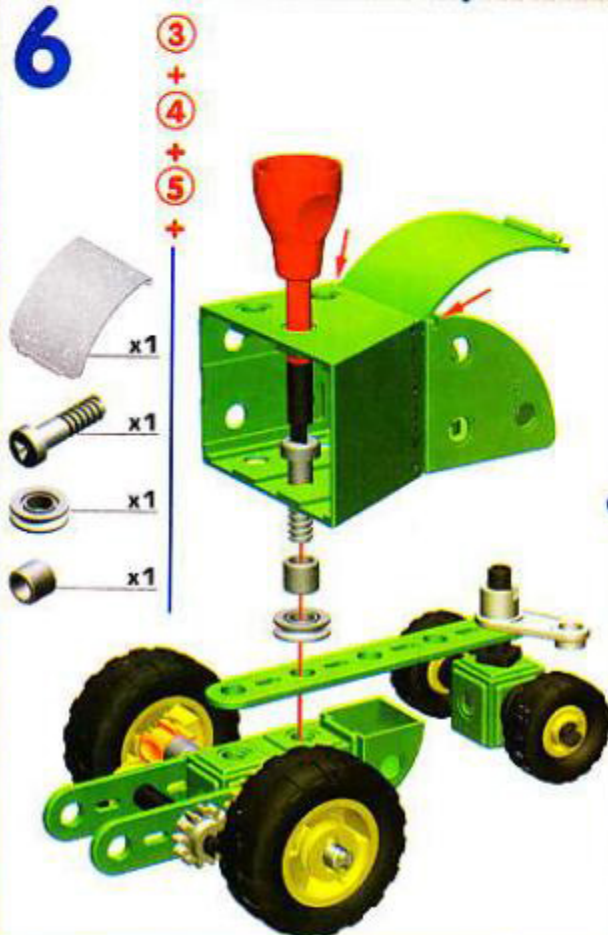

# 7

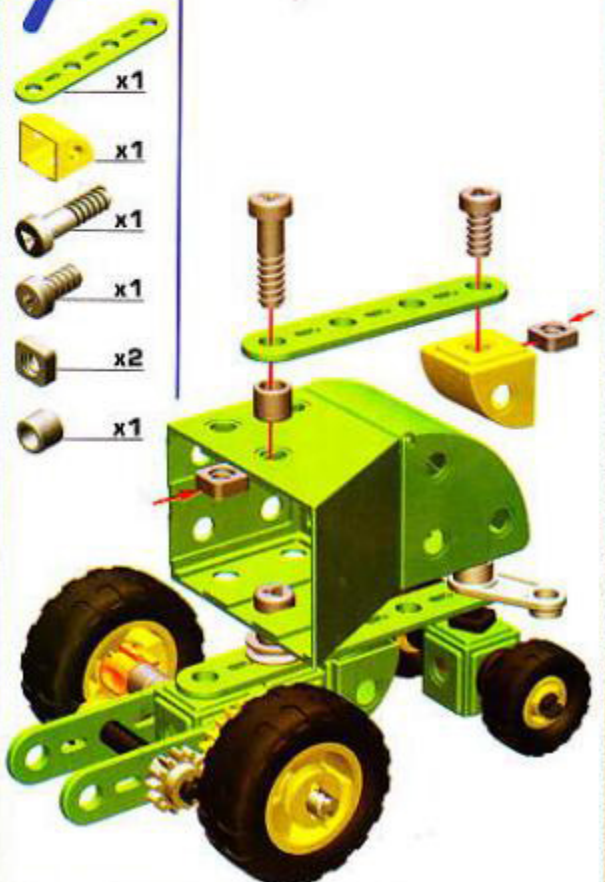



# 8

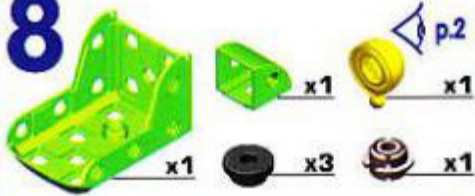

# 9

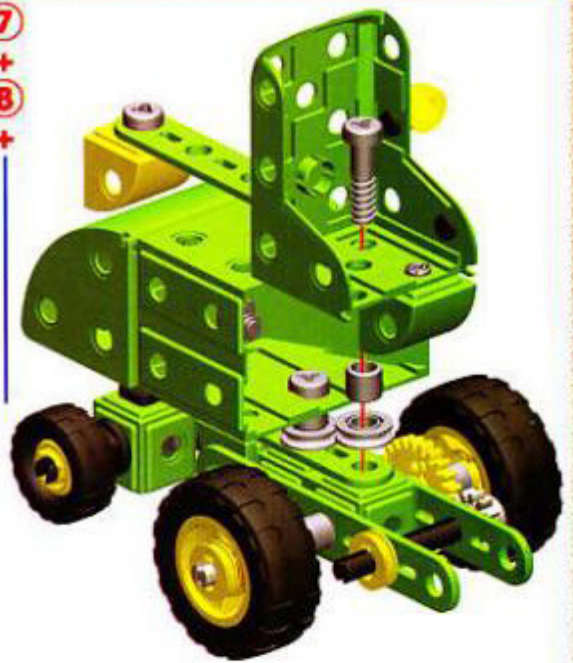

# 10





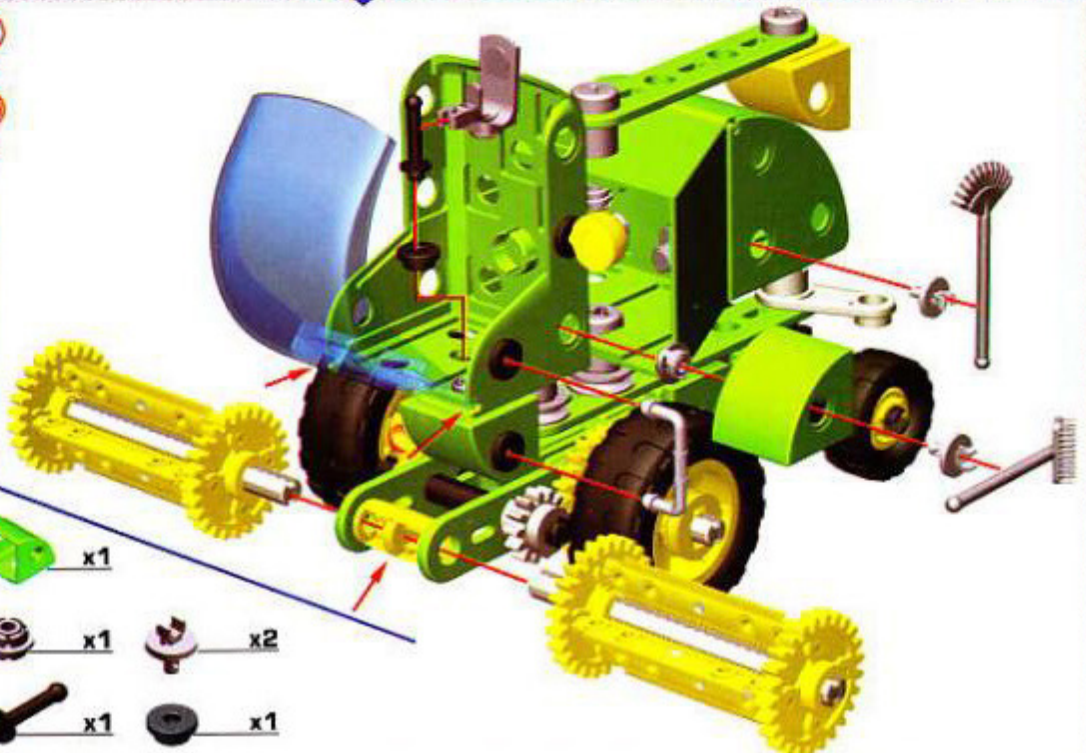
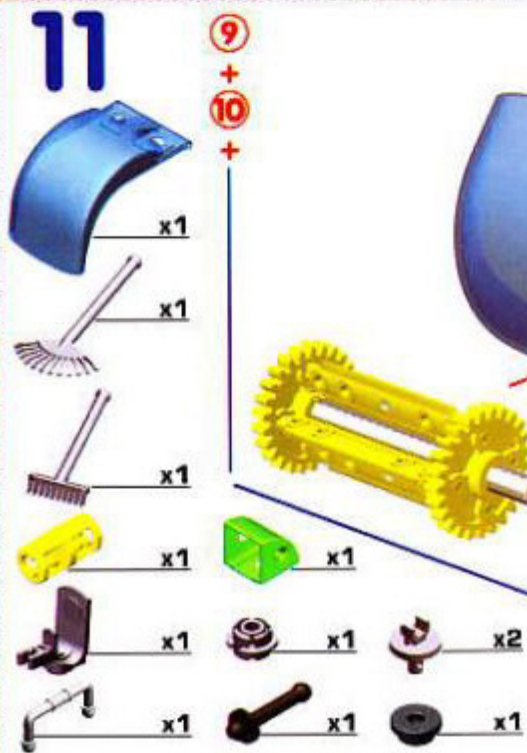

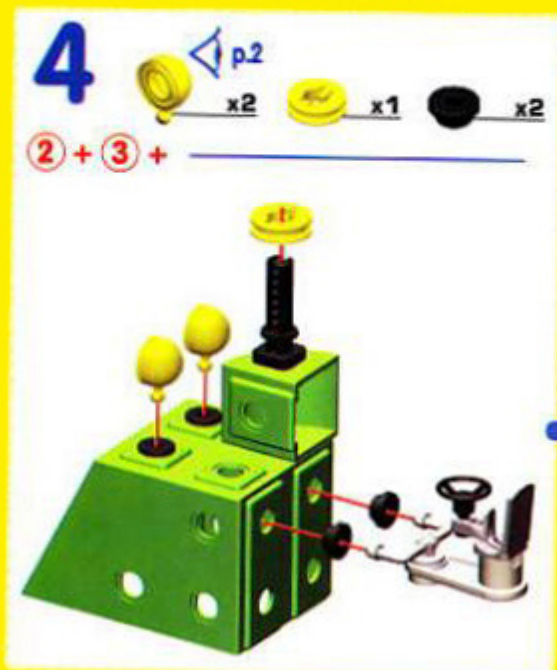
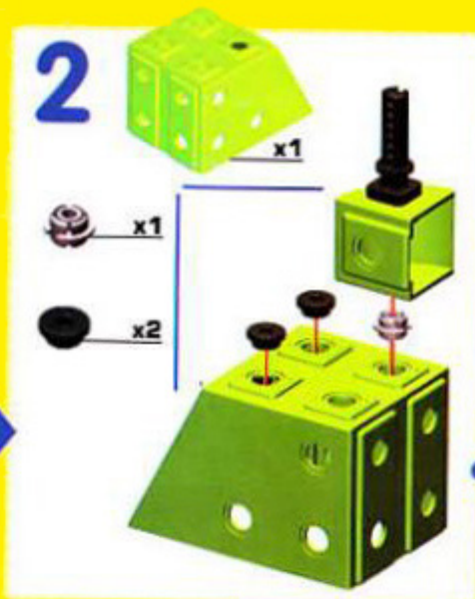
# 11





# 6

-  x1
-  x1
-  x2
-  x1
-  x1

# 4

+ 5

# 5

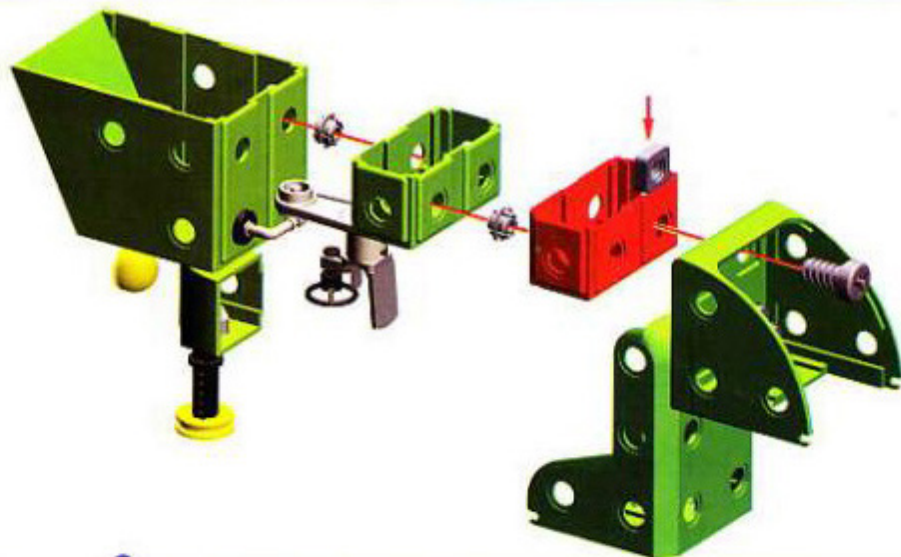



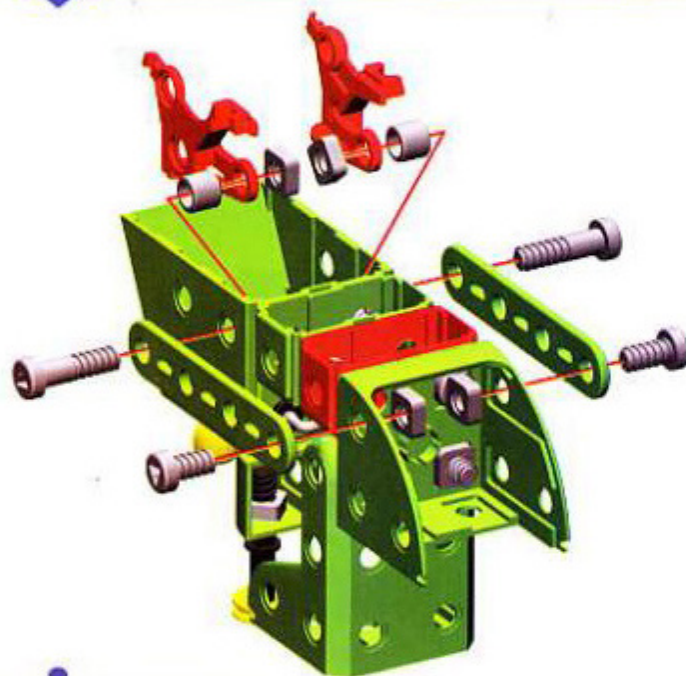

# 7

-  x2
-  x1
-  x1
-  x2
-  x2
-  x2
-  x4

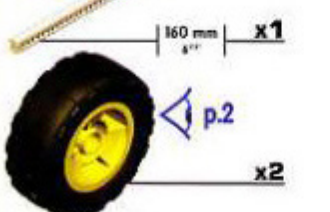
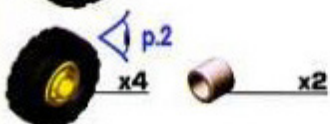

# 8

-  160 mm x1
-  p.2 x2
-  p.2 x4
-  x2
-  x2
-  x2
-  x4

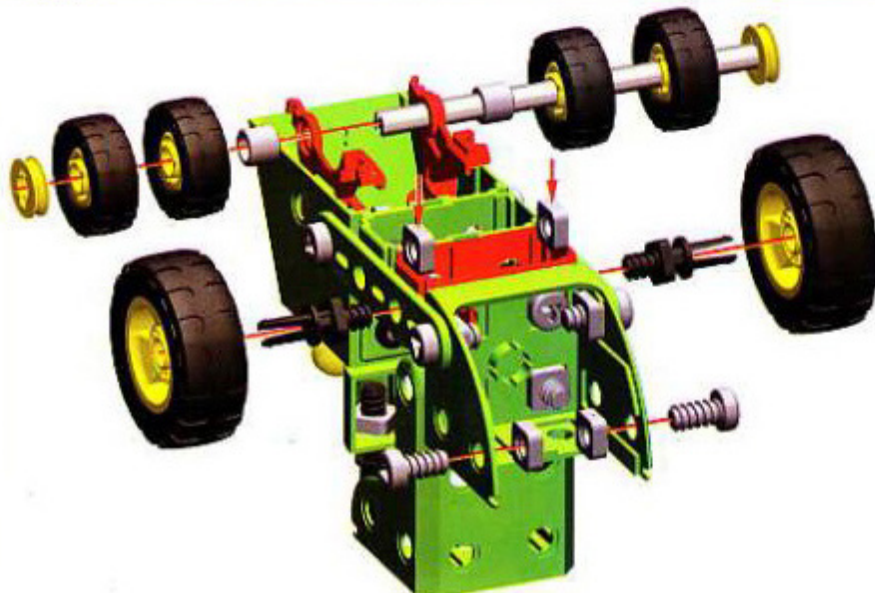

# 9

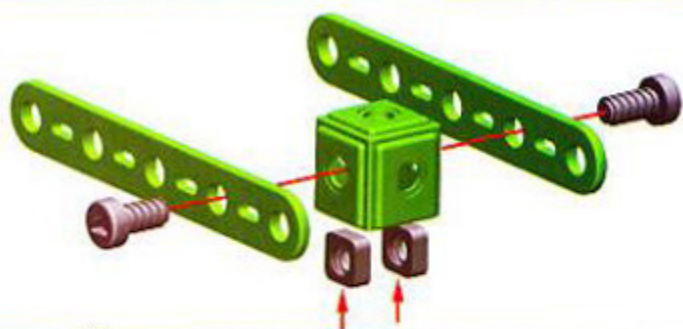
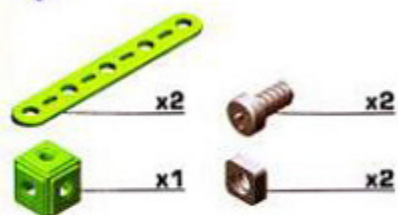

# 10

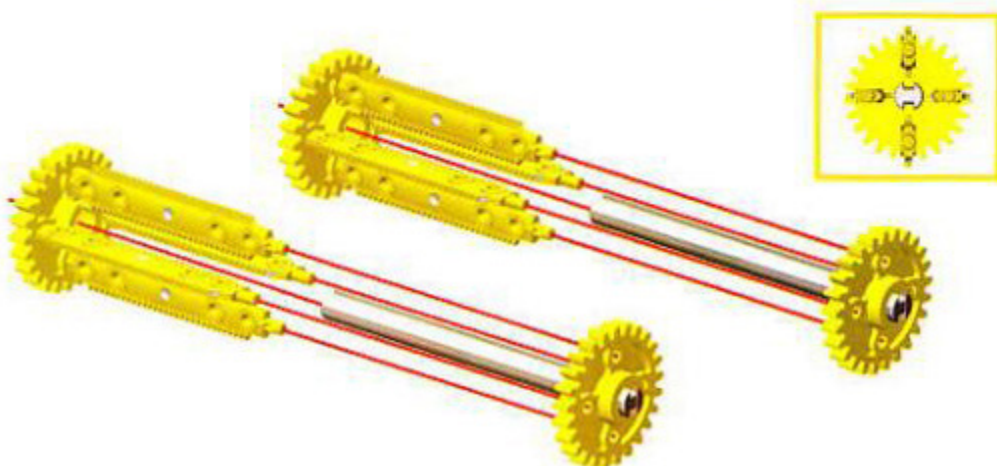

# 11

8  
+  
9  
+  
10  
+





1



2

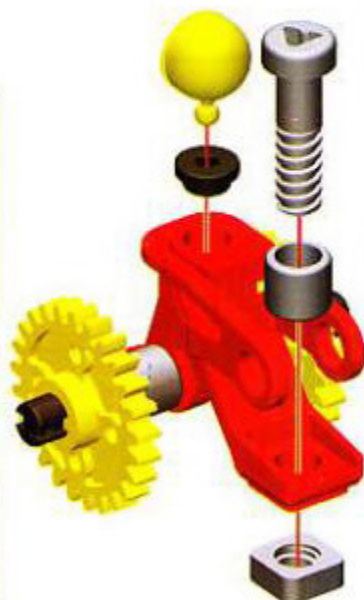
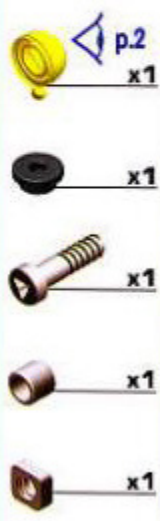

3

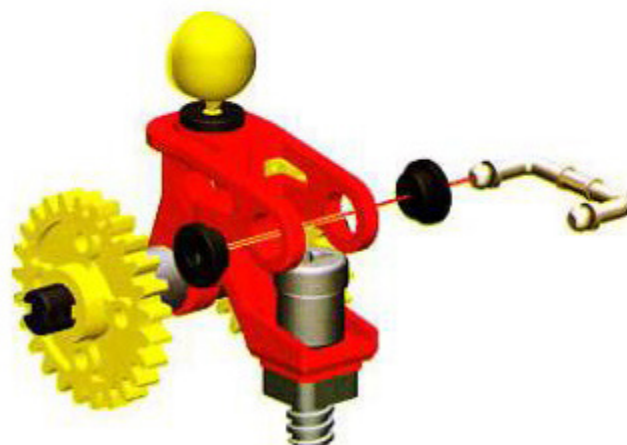
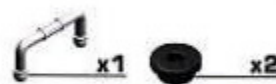

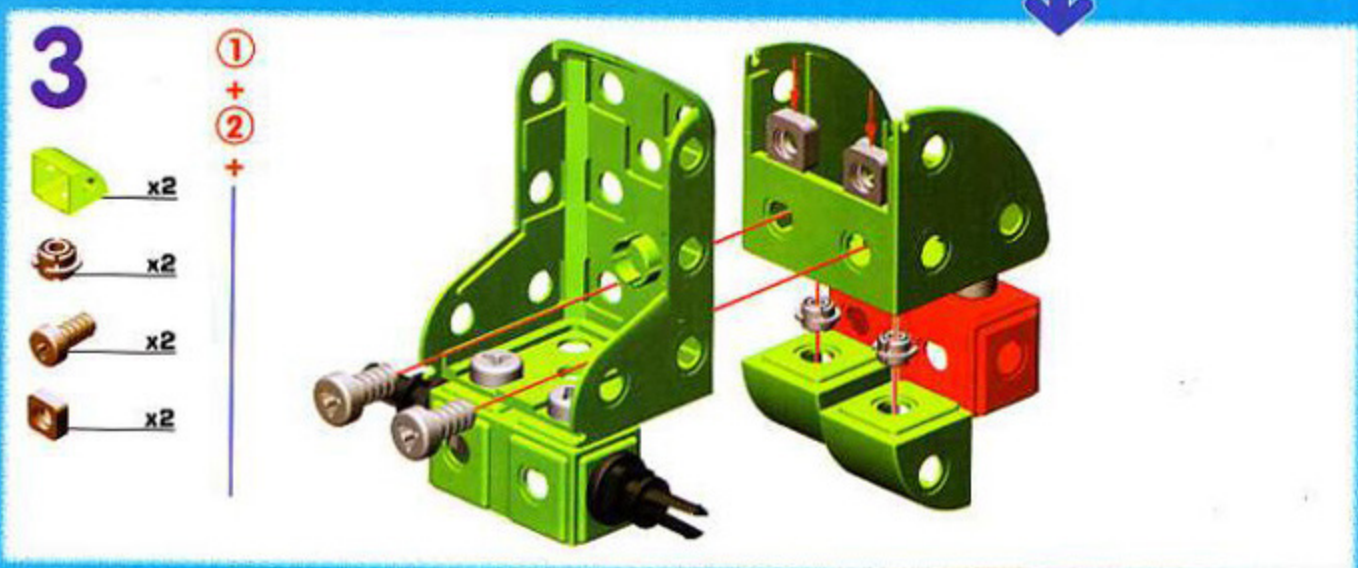
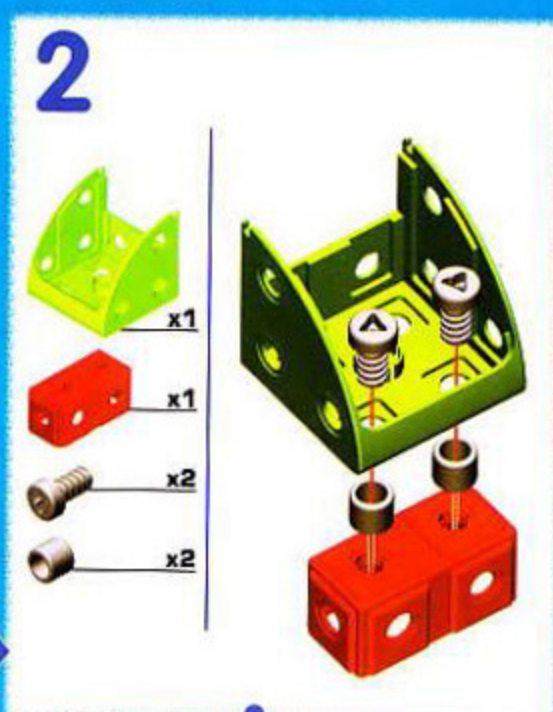

# 4

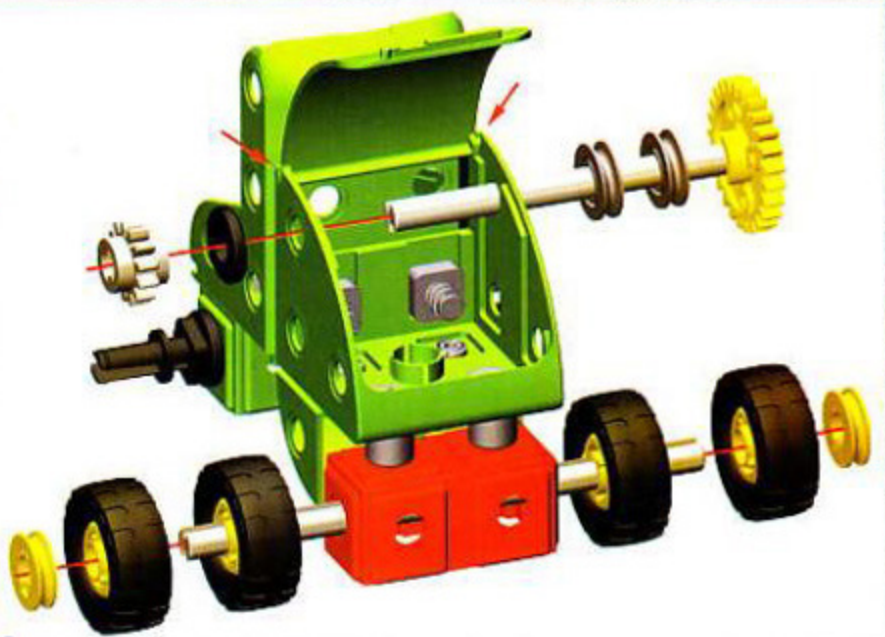

# 5

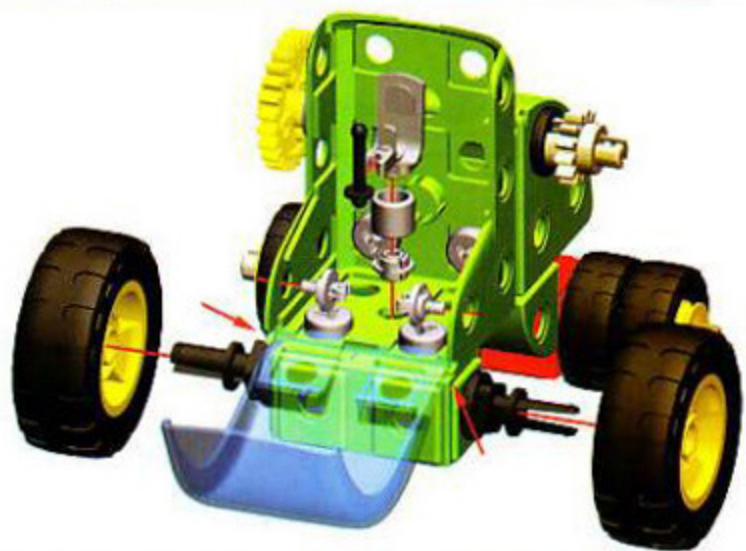

# 6

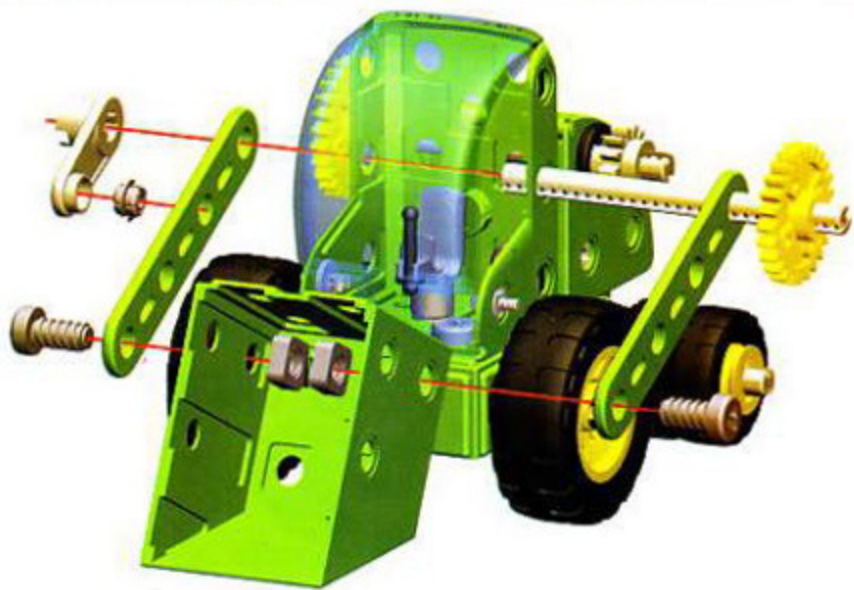
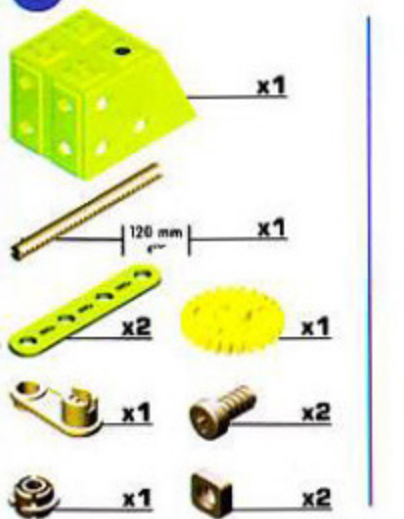

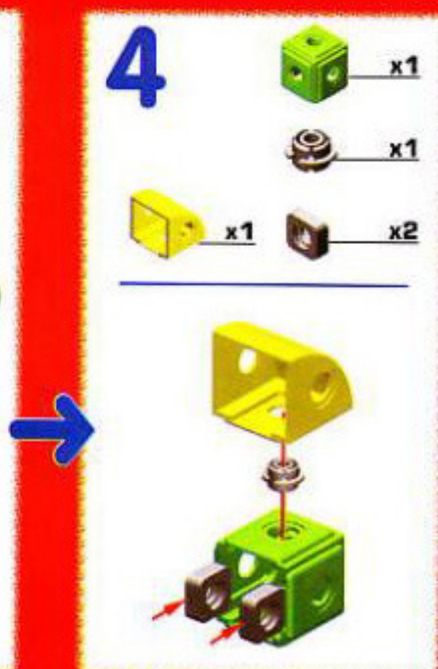
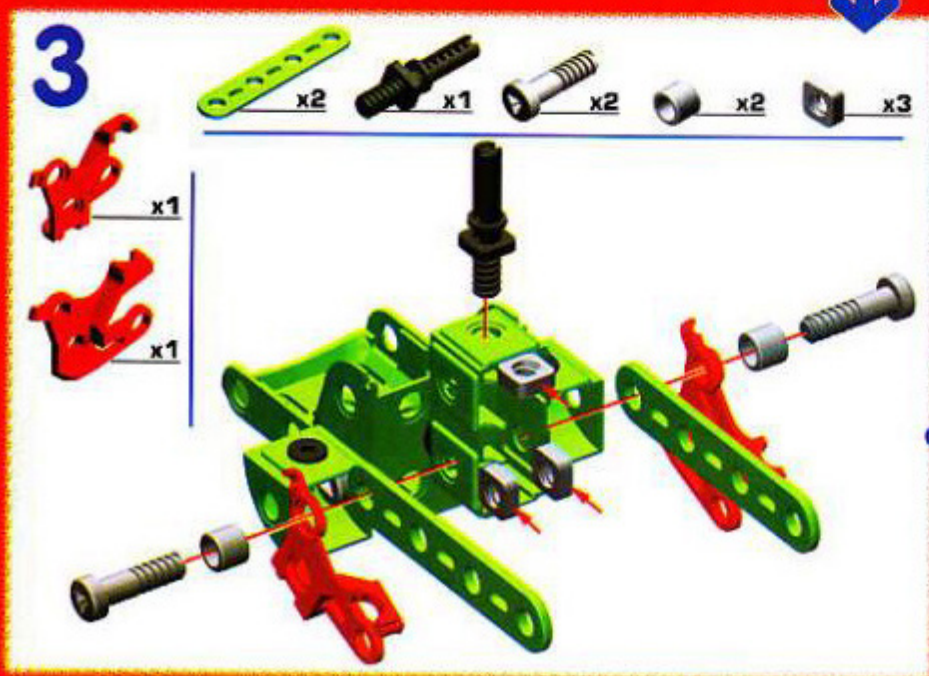
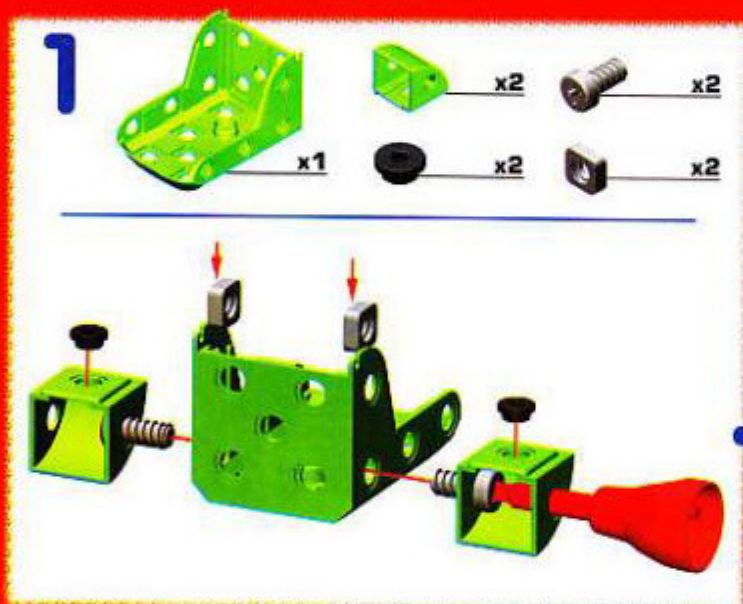



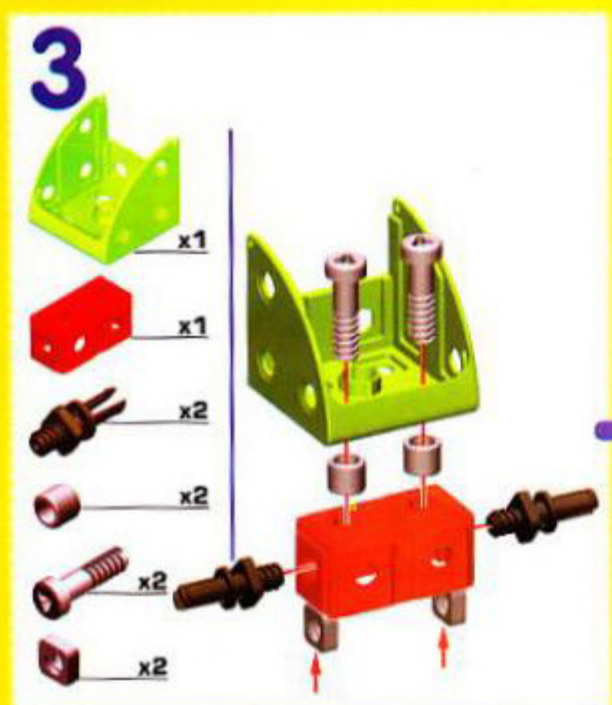
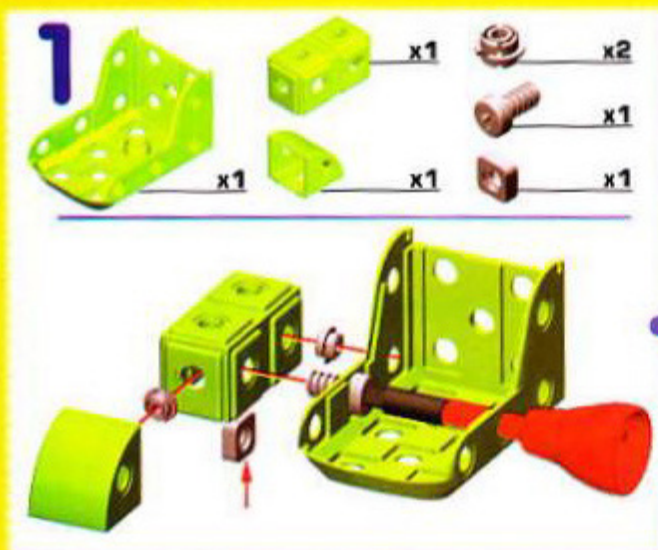

# 5

- 120 mm 4" x2
- x1
- x2
- p.2 x2
- x2
- x1

- x1
- x1
- x1
- x1
- x1
- x1
- x1

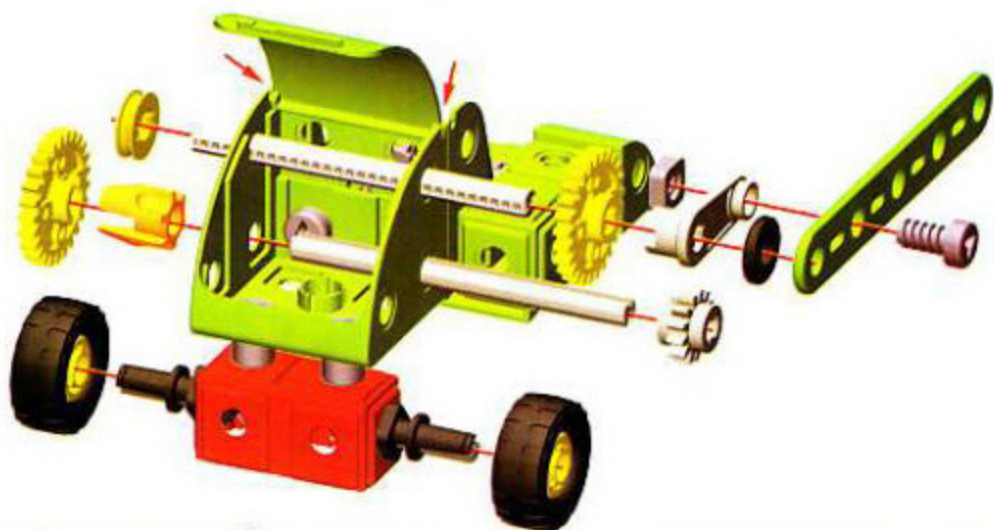

# 6

- x1
- x2
- x1
- x2
- x1
- x2

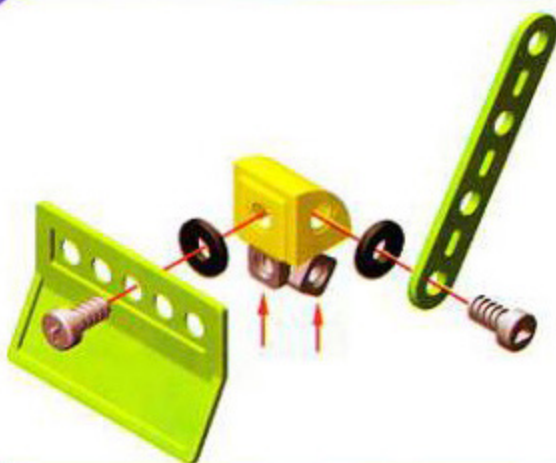





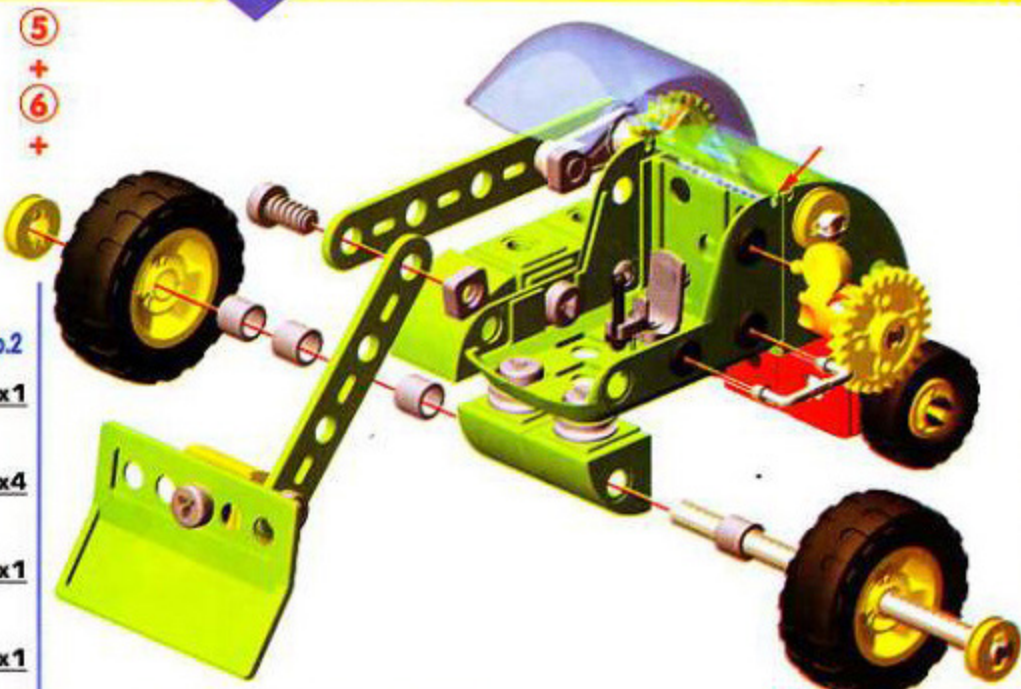

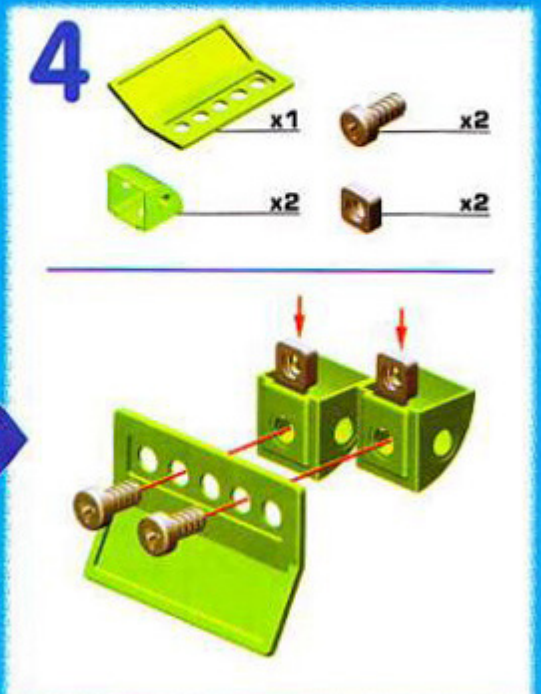
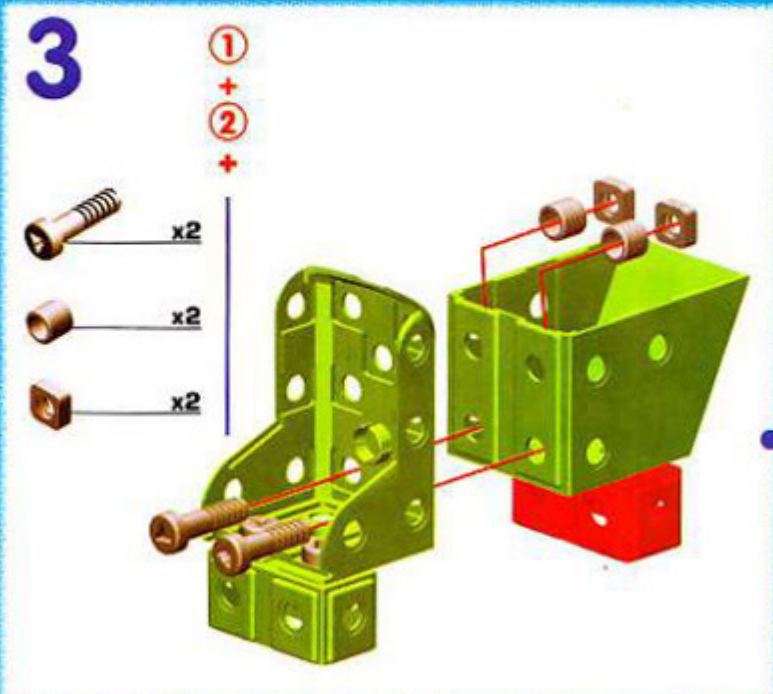
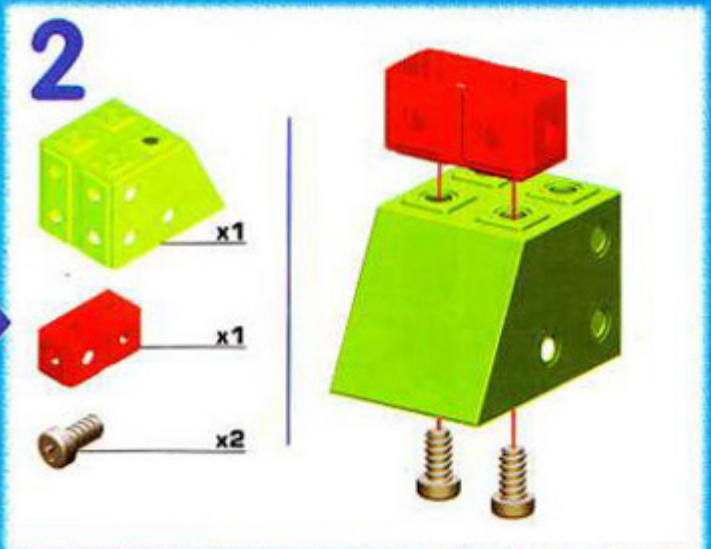
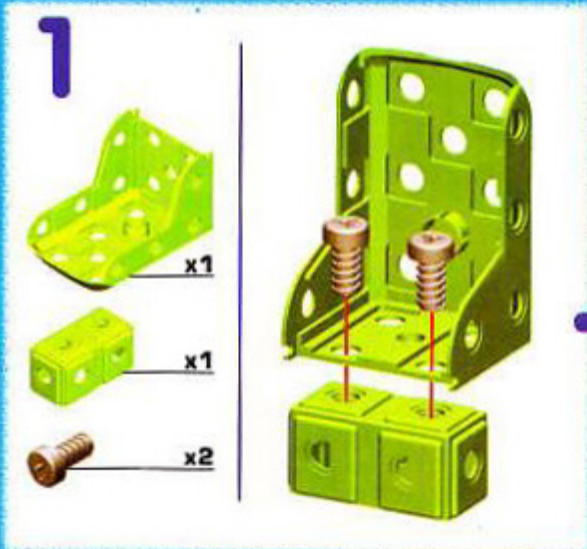
# 7

- 160 mm 6" x1
- x1
- p.2
- x2
- x1
- x4
- x1
- x1
- x2
- x1





# 5

-  x2
-  x1
-  x1
-  p.2  
x4
-  x4
-  x2
-  x4

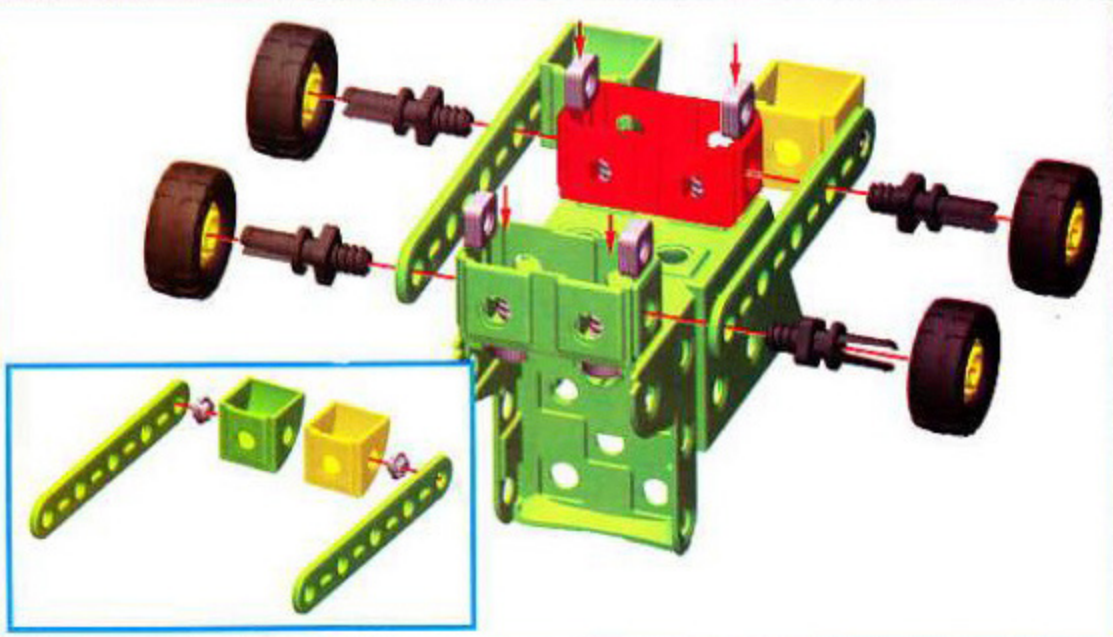

# 6

-  120 mm x2
-  x2
-  x1
-  x2
-  x1
-  x1
-  x3
-  x2
-  x1
-  x2
-  x2

④  
+  
⑤  
+

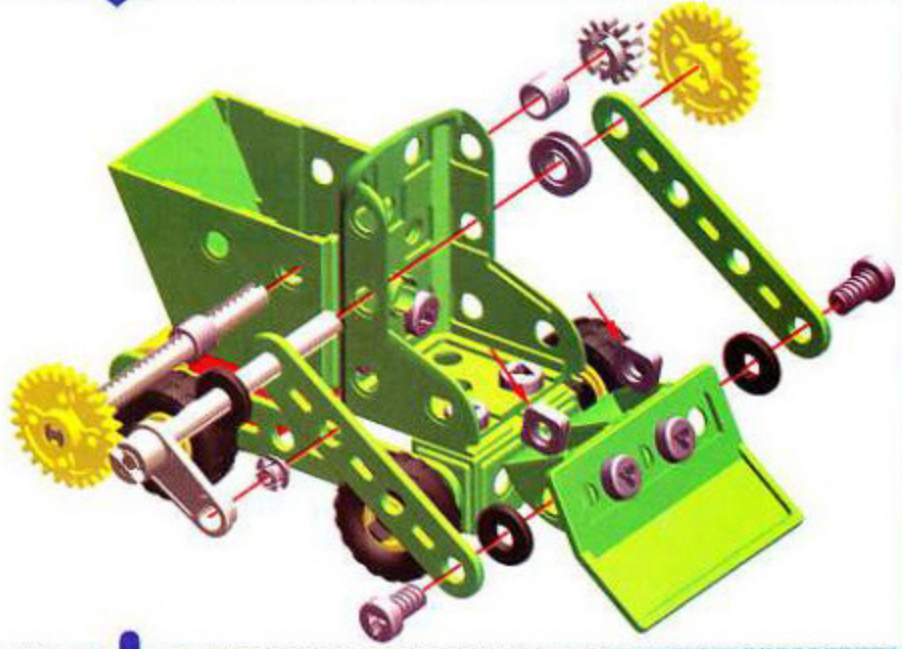

# 7

-  x1
-  x1
-  x1
-  x1
-  x1



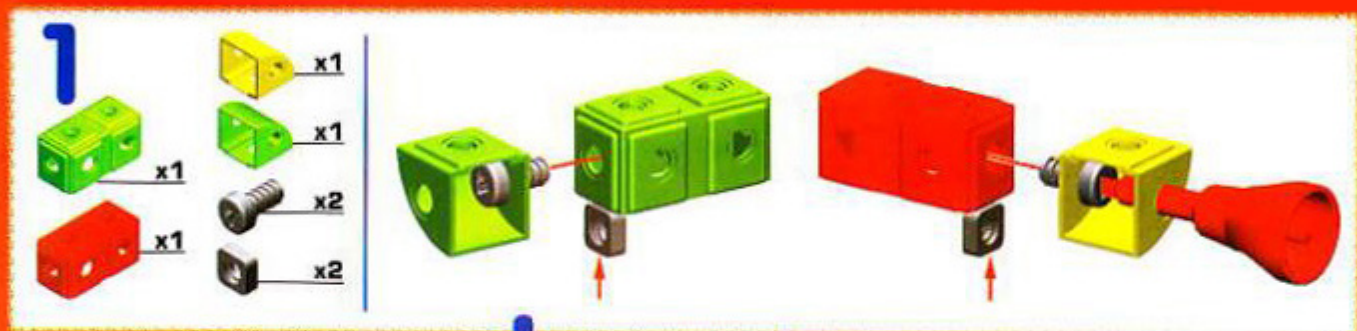

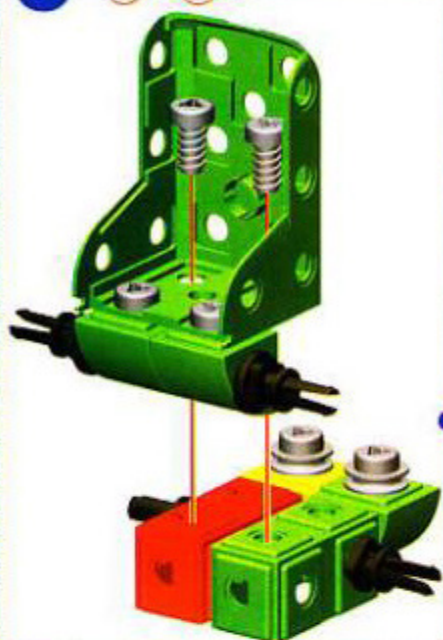
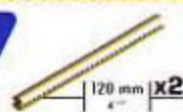
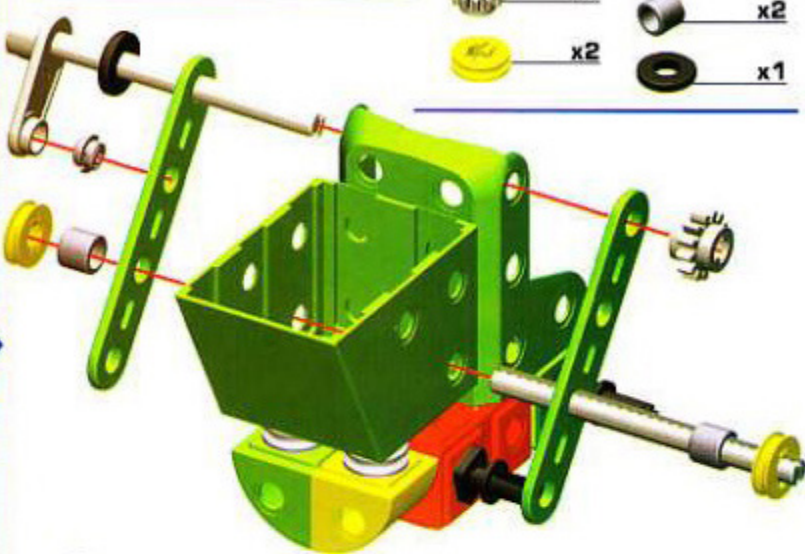
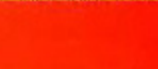
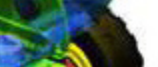
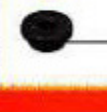
**6****3 + 5 +****x2****7****x2****x1****x2****x1****x1****x2****x1****8****p.2****x4****x1****x1****x1****p.2****x1****x4****9****x1****x1****x1****x1****p.2****x1**

**USA** Many of the models and component parts are unique and original designs which are the property of MECCANO S.N. They are protected by national legislation as industrial designs, trademarks and/or copyrights throughout many countries. For detailed information, please contact: MECCANO S.N. Meccano S.N. shall have no responsibility for (i) failure to follow instructions, (ii) use of parts for any purpose other than as specified in the instructions (iii) any alteration of any parts or components. MECCANO S.N. respects children's safety: all models are tested by children.

**F** De nombreux modèles et pièces sont des créations originales, propriétés de MECCANO S.N. et sont protégés par les législations nationales sur les dessins et modèles, marques et/ou droits d'auteurs. Pour toute information, merci de contacter : MECCANO S.N. La responsabilité de MECCANO S.N. ne saurait être engagée en cas d'accident survenu à la suite (i) du non respect des instructions de montage (ii) d'une utilisation des pièces autre que celle proposée dans la notice (iii) d'une altération ou de la modification des pièces. La société MECCANO respecte la sécurité des enfants : ses modèles sont testés par des enfants.

**D** Zahlreiche Modelle und Teile sind Erfindungen und Eigentum der Firma MECCANO S.N. Sie sind durch Inland-Gesetze über Zeichnungen und Modelle sowie Warenzeichen und/oder Urheberrechte geschützt. Für zusätzliche Auskünfte wenden Sie sich bitte an : MECCANO S.N. Die Firma Meccano S.N. haftet nicht für Unfälle, die aus der (i) Nichteinhaltung der Bauanleitung, der (ii) Verwendung anderer als in der Bauanleitung angegebenen Teile oder der (iii) Änderung oder Modifikation der Teile resultieren. Alle Modelle der Firma Meccano wurden von Kindern getestet und entsprechen den Sicherheitsnormen.

**I** Numerosi modelli e pezzi sono creazioni originali della MECCANO S.N. e sono protetti dalle legislazioni nazionali sui disegni e modelli, marche e/o diritti d'autore. Per qualsiasi informazione, vogliate prendere contatto con : MECCANO S.N. Meccano S.N. declina ogni responsabilità in caso d'incidenti sopravvenuti in seguito (i) a: non rispetto delle istruzioni di montaggio (ii) utilizzo dei pezzi per funzioni diverse da quelle previste nel manuale (iii) alterazione e/o modifica dei pezzi. La società MECCANO rispetta la sicurezza dei bambini : i suoi modelli vengono testati dai bambini stessi.

**E** Numerosos modelos y piezas son creaciones originales, propiedades de MECCANO S.N. y están protegidos por las legislaciones nacionales en lo que concierne a los dibujos y modelos, marcas y/o derechos de autor. Para cualquier información, sírvase ponerse en contacto con : MECCANO S.N. MECCANO S.N. carece de responsabilidad en caso de accidente debido a: (i) el incumplimiento de las instrucciones de montaje (ii) una utilización de las piezas diferente a la que se indica en las instrucciones (iii) una alteración o modificación de las piezas. La sociedad MECCANO respeta la seguridad de los niños : sus modelos están probados por niños.

**P** Vários modelos e peças são criações originais, propriedades da MECCANO S.N. e são protegidos pelas legislações nacionais relativas aos desenhos e modelos, às marcas e/ou aos direitos de autor. Para qualquer informação, é favor contactar : MECCANO S.N. A Sociedade MECCANO S.N. não poderá ser responsabilizada pelos acidentes provocados: (i) pela falta de cumprimento das instruções de montagem (ii) pelo uso indevido das peças ou (iii) pela modificação ou alteração das peças. A Sociedade MECCANO respeita a segurança das crianças : os seus modelos foram testados por crianças

**S** Många modeller och delar bildar en unik och originell formgivning vilken är MECCANO S.N. egendom. Dessa modeller och delar är skyddade genom lagstiftning såsom industriell formgivning, varumärke och/eller upphovsmannarätt i ett flertal länder. För mer detaljerad information, var vänlig och kontakta MECCANO S.N. MECCANO S.N. frångår sig allt ansvar i händelse av olycka till följd av (i) att monteringsinstruktionerna inte har respekterats (ii) en annan användning av delarna än den som står i anvisningen (iii) en förvanskning eller förändring av delarna. Företaget MECCANO respekterar barnsäkerheten : modellerna har testats av barn.

**FIN** Useat mallit ja osat ovat MECCANO S.N.:n omaisuutta olevaa alkuperäistä suunnittelua. Ne ovat kansallisilla lailla suojattua teollista tuotantoa, tavaramerkkejä ja/tai kopiointioikeuksia. Pyydämme ottamaan yhteyden MECCANO S.N.:han kaikissa asiaan liittyvissä kysymyksissä. MECCANO S.N. ei vastaa eikä kata seuraavista syistä sattuneita onnettomuuksia: (i) ohjeiden vastainen kokoaminen, (ii) muiden kuin ohjeissa ehdotettujen osien käyttö, (iii) osien muuntelu tai eri tarkoitukseen käyttö. MECCANO-yhtiö huolehtii lasten turvallisuudesta: lapset ovat testanneet mallimme.

**DK** Vore mange modeller og dele er originale fremstillinger og ejes af MECCANO S.N. Tegninger, modeller, fabrikmærker og ophavsret er lovbeskyttede i hvert land. Yderligere oplysninger kan fås hos: MECCANO S.N. MECCANO S.N. frasiger sig ethvert ansvar, såfremt der er sket uheld forårsaget af (i) at monteringsinstruktionerne ikke er blevet overholdt, (ii) at delene er blevet brugt til andre formål, end dem der er beskrevet i betjeningsvejledningen, (iii) eller at delene er blevet beskadiget eller ændret. MECCANO overholder sikkerhedsreglerne for børn. Alle modeller testes af børn.

**NL** Veel modellen en onderdelen zijn originele ontwerpen en eigendom van MECCANO S.N. en worden beschermd door de nationale wetgevingen op tekening en modellen, merken en/of auteursrechten. Voor informatie gelieve contact op te nemen met MECCANO S.N. De verantwoordelijkheid van MECCANO S.N. is uitgesloten in geval van ongevallen voortkomend uit het niet naleven van de montage-instructies (i), uit het gebruik van andere onderdelen dan die zoals vermeld in de handleiding (ii) of uit het veranderen of modificeren van de onderdelen (iii). De firma MECCANO neemt de veiligheid van de kinderen in acht : de modellen zijn door kinderen getest.

**GR** Πολλά μοντέλα και ανταλλακτικά είναι αυθεντικά, ιδιοκτησία της MECCANO S.N. και προστατεύονται από τις εθνικές νομοθεσίες για τα μοντέλα τις marcas, ή τα διπλώματα ευρεσιτεχνίας. Για κάθε πληροφορία παρακαλώ απευθυνθείτε στη MECCANO S.N. Η ευθύνη της MECCANO S.N. δεν δεσμεύεται σε περίπτωση ατυχήματος που έγινε συνέχεια (i) μη σεβασμού των οδηγιών συναρμολόγησης (ii) χρήσης των τεμαχίων διαφορετικά από αυτήν που προτείνεται στις οδηγίες (iii) καταστροφή ή αλλαγή των τεμαχίων. Η εταιρεία MECCANO σέβεται την ασφάλεια των παιδιών, τα μοντέλα της δοκιμάζονται από παιδιά.

**JPN** モデルならびに部品は、その多くが MECCANO 社所有のオリジナル・デザインで、登録・商標および/または著作権に關する国内法によって保護されています。詳細については、請社 (MECCANO S.N.) \*カズバは (i) 組立の注意事項を守らなかった場合、(ii) 使用説明書に記載されたもの以外の部品を使用した場合 (iii) 部品を改造・改造した場合などに起きた事故については責任を負うことはできません。\*カズバのモデルは事前に子供たちによりテストを行い、その安全性を確認されています。

Made in France by/Fabriqué en France par/Fabricado en Francia por :



© 06/2002 MECCANO S.N. 363, avenue de Saint Exupéry - F 62100 CALAIS

© MECCANO and ERECTOR are exclusive trademarks of MECCANO S.N.

All rights reserved

<http://www.meccano.com>