

# MECCANO™ JUNIOR

**PULL BACK BUGGY  
VÉHICULE TOUT-TERRAIN**

20105



**STEAM**



**WARNING:**

**CHOKING HAZARD** – Small parts.  
Not for children under 3 years.



**ATTENTION !**

**DANGER D'ÉTOUFFEMENT** – Contient de petits éléments.  
Ne convient pas aux enfants de moins de 3 ans.



EN Instructions ES Notice de montage ES Instrucciones de construcción  
DE Bauanleitung NL Bouwinstructie IT Istruzioni PT Instruções  
RU Инструкции PL Instrukcja CZ Pokyny SK Pokyny HU Útmutató  
RO Instrucțiuni EL Οδηγίες HR Upute BG Инструкции SI Navodila



## EN TOOLS INCLUDED FR OUTILS INCLUS

- ES HERRAMIENTAS INCLUIDAS DE WERKZEUGE ENTHALTEN
- NL GEREEDSCHAP INBEGREPEN IT ATTREZZI INCLUSI
- PT FERRAMENTAS INCLUSAS RU ИНСТРУМЕНТЫ ВХОДЯТ В КОМПЛЕКТ
- PL NARZĘDZIA W ZESTAWIE CZ NÁSTROJE SOUČÁSTÍ BALENÍ
- SK OBSAHUJE NÁSTROJE HU SZERSZÁMOK MELLÉKELVE
- RO INSTRUMENTE INCLUSE EL ΠΕΡΙΛΑΜΒΑΝΟΝΤΑΙ ΕΡΓΑΛΕΙΑ
- HR ALAT U PAKETU BG ВКЛЮЧЕНИ ИНСТРУМЕНТИ
- SL ORODJE JE PRILOŽENO

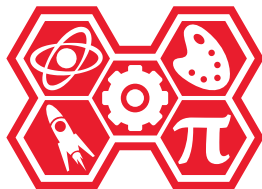
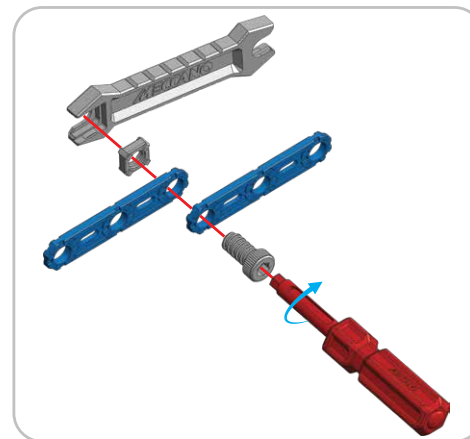

EN For information on how this product supports today's STEAM curriculum, visit [www.meccano.com](http://www.meccano.com).

FR Pour découvrir l'intérêt pédagogique de ce produit dans le cadre des matières STEAM, rendez-vous sur [www.meccano.com](http://www.meccano.com).

ES Para mayor información sobre cómo este producto respalda las materias STEAM visita: [www.meccano.com](http://www.meccano.com).

DE Für Informationen, wie dieses Produkt den technisch-mathematischen Lehrplan (MINT) unterstützt, besuchen Sie bitte [www.meccano.com](http://www.meccano.com).

NL Ga naar [www.meccano.com](http://www.meccano.com) voor meer informatie over hoe dit product het huidige STEM-curriculum ondersteunt.

IT Per informazioni su come questo prodotto contribuisce ad aiutare i ragazzi nelle materie STEAM "scientifiche, artistiche e tecniche", visitare il sito [www.meccano.com](http://www.meccano.com).

# STEAM

PT Para informações sobre a compatibilidade deste produto com os programas atuais STEAM, acesse [www.meccano.com](http://www.meccano.com).

RU Информация о том, как с помощью этого продукта можно повысить эффективность процесса изучения дисциплин STEAM, представлена на сайте [www.meccano.com](http://www.meccano.com).

PL Aby dowiedzieć się więcej na temat wspierania programu nauczania STEAM przez markę Meccano, odwiedź stronę [www.meccano.com](http://www.meccano.com).

CZ Informace o tom, jakým způsobem tento produkt zapadá do studijního programu STEAM, naleznete na webu [www.meccano.com](http://www.meccano.com).

SK Viac informácií o tom, ako tento výrobok podporuje najnovší študijný program STEAM, nájdete na webovej lokalite [www.meccano.com](http://www.meccano.com).

HU A [www.meccano.com](http://www.meccano.com) weboldalon további információkat talál arról, hogy a termék hogyan járul hozzá napjaink STEAM programjához.

RO Pentru informații privind modul în care acest produs este compatibil cu sistemul de educație STEAM, vizitați [www.meccano.com](http://www.meccano.com).

EL Για πληροφορίες σχετικά με τον τρόπο με τον οποίο αυτό το προϊόν υποστηρίζει το τωρινό πρόγραμμα της πρωτοβουλίας STEAM, επισκεφθείτε τη διεύθυνση [www.meccano.com](http://www.meccano.com).

HR Informacije o tome kako ovaj proizvod podržava STEAM kurikulum potražite na [www.meccano.com](http://www.meccano.com).

BG За информация относно това как този продукт подкрепя учебната програма STEAM днес посетете [www.meccano.com](http://www.meccano.com).

SL Za več informacij o tem, kako ta izdelek podpira današnje izobraževanje na področju znanosti, tehnologije, inženirstva in matematike (ang. STEAM), obiščite spletno mesto [www.meccano.com](http://www.meccano.com).

## TABLE OF CONTENTS / SOMMAIRE

ÍNDICE / INHALTSVERZEICHNIS / INHOUD / INDICE / ÍNDICE / СОДЕРЖАНИЕ / SPIS TREŚCI / OBSAH / OBSAH  
TARTALOMJEGYZÉK / CUPRINS / ΠΙΝΑΚΑΣ ΠΕΡΙΕΧΟΜΕΝΩΝ / SADRŽAJ / СЪДЪРЖАНИЕ / VSEBINA



AVAILABLE ONLINE / DISPONIBLES EN LIGNE

DISPONIBLES EN LÍNEA / ONLINE VERFÜGBAR / ONLINE VERKRIJGBAAR  
DISPONIBILI ONLINE / DISPONÍVEL ONLINE / ДОСТУПНЫ ОНЛАЙН  
DOSTĘPNE W INTERNECIE / K DISPOZICI ONLINE / DOSTUPNÝ ONLINE  
ONLINE ELÉRHETŐ / DISPONIBILE ONLINE / ΔΙΑΤΙΘΕΝΤΑΙ ΣΤΟ ΔΙΑΔΙΚΤΥΟ  
DOSTUPNO NA INTERNETU / ДОСТЪПНО ОНЛАЙН  
NA VOLJO NA SPLETU



Ⓜ **Content:** 138 parts, 2 tools, 1 sticker sheet and 1 instruction sheet for 2 models. Ⓜ **Contenu :** 138 pièces, 2 outils, 1 feuille d'autocollants et 1 notice de montage pour 2 modèles. Ⓜ **Contenido:** 138 piezas, 2 herramientas, 1 hoja de calcomanías y 1 guía de instrucciones para 2 modelos. Ⓜ **Inhalt:** 138 Teile, 2 Werkzeuge, 1 Bogen mit Aufklebern, 1 Bauanleitung für 2 Modelle. Ⓜ **Inhoud:** 138 onderdelen, 2 stuks gereedschap, 1 stickervel en 1 bouwstructuur voor 2 modellen. Ⓜ **Contenuto:** 138 pezzi, 2 attrezzi, 1 foglio di adesivi e 1 guida per l'uso per 2 modelli. Ⓜ **Conteúdo:** 138 peças, 2 ferramentas, 1 folha de adesivos e 1 folha de instruções para 2 modelos. Ⓜ **В комплекте:** 138 деталей, 2 инструмента, 1 лист с наклейками и 1 инструкция по сборке 2 моделей. Ⓜ **Zawartość:** 138 elementów, 2 narzędzia, 1 arkusz naklejek i 1 karta z instrukcjami dla 2 modeli. Ⓜ **Obsah:** 138 dílů, 2 nástroje, 1 list se samolepkami a 1 list s pokyny pro 2 modely. Ⓜ **Obsah:** 138 dielov, 2 nástroje, 1 hárok s nálepkami a 1 hárok s pokynmi pre 2 modely. Ⓜ **Tartalom:** 138 db alkatrész, 2 db szerszám, 1 db matricalap és 1 db 2 modelhez tartozó felhasználói útmutató. Ⓜ **Conținut:** 138 de piese, 2 unelte, 1 foaie cu autocolante și 1 fișă cu instrucțiuni pentru 2 modele. Ⓜ **Περιχόμενα:** 138 κομμάτια, 2 εργαλεία, 1 φύλλο με αυτοκόλλητα και 1 φύλλοδιο οδηγιών για 2 μοντέλα. Ⓜ **Sadržaj:** 138 dijelova, 2 alata, 1 list s naljepnicama i 1 list s uputama za 2 modela. Ⓜ **Съдържание:** 138 части, 2 инструмента, 1 лист със стикери и 1 ръководство с инструкции за 2 модела. Ⓜ **Vsebina:** 138 delov, 2 orodij, 1 list z nalepkami in 1 list z navodili za 2 modela.

Ⓜ Building instructions for the other model is available at [www.meccano.com](http://www.meccano.com). Ⓜ La notice de montage de l'autre modèle est disponible sur [www.meccano.com](http://www.meccano.com). Ⓜ Hay instrucciones de construcción disponibles para el otro modelo en [www.meccano.com](http://www.meccano.com). Ⓜ Bauanleitungen für das andere Modell sind auf [www.meccano.com](http://www.meccano.com) zu finden. Ⓜ Bouwinstructies voor het andere model zijn verkrijgbaar op [www.meccano.com](http://www.meccano.com). Ⓜ Le istruzioni di montaggio dell'altro modello sono disponibili alla pagina [www.meccano.com](http://www.meccano.com). Ⓜ Instruções de montagem para o outro modelo disponíveis em [www.meccano.com](http://www.meccano.com). Ⓜ Инструкции по сборке другой модели можно найти на сайте [www.meccano.com](http://www.meccano.com). Ⓜ Instrukcje montażu innych modeli można znaleźć na stronie [www.meccano.com](http://www.meccano.com). Ⓜ Sestavovací pokyny pro další model naleznete na webu [www.meccano.com](http://www.meccano.com). Ⓜ Pokyny na stavanie ďalšieho modelu sú dostupné na webovej lokalite [www.meccano.com](http://www.meccano.com). Ⓜ A [www.meccano.com](http://www.meccano.com) weboldalon további modellekhez tartozó összerakási útmutatókat talál. Ⓜ Instrucțiunile de construire pentru celălalt model sunt disponibile la adresa [www.meccano.com](http://www.meccano.com). Ⓜ Οι οδηγίες κατασκευής για το άλλο μοντέλο διατίθενται στη διεύθυνση [www.meccano.com](http://www.meccano.com). Ⓜ Upute za sastavljanje drugog modela dostupne su na stranici [www.meccano.com](http://www.meccano.com). Ⓜ Инструкциите за сглобяване за другия модел са достъпни на [www.meccano.com](http://www.meccano.com). Ⓜ Navodila za sestavljanje drugega modela so na voljo na [www.meccano.com](http://www.meccano.com).





**EN.** Only one model can be built at a time. **FR.** Les pièces fournies ne permettent de monter qu'un seul modèle à la fois. **ES.** Solo es posible construir un modelo a la vez. **DE.** Jeweils nur eins der Modelle baubar. **NL.** Er kan maar een model tegelijk worden gebouwd. **IT.** Permette di realizzare un solo modello per volta. **PT.** Só é possível montar um modelo de cada vez. **RU.** Одновременно можно построить только одну модель. **PL.** Jednocześnie można zbudować tylko jeden model. **CZ.** Najednou lze sestavit pouze jeden model. **SK.** Modely sa dajú vytvoríť len po jednom. **HU.** Egyszerre csak egy modell rakható össze. **RO.** Nu pot fi construite mai multe modele în același timp. **EL.** Μπορείτε να δημιουργείτε μόνο ένα μοντέλο κάθε φορά. **HR.** Istovremeno ne možete sastaviti više modela. **BG.** Само един модел може да бъде сглобен едновременно. **SL.** Sestavite lahko samo en model naenkrat.

	<b>D659 x27</b>		<b>A077 x2</b>		<b>D681 x1</b>		<b>D642 x5</b>
	<b>D661 x4</b>		<b>A057 x2</b>		<b>D652 x1</b>		<b>D643 x5</b>
	<b>A132 x2</b>		<b>D689 x1</b>		<b>D688 x1</b>		<b>D645 x2</b>
	<b>D660 x30</b>		<b>D688 x1</b>		<b>D663 x4</b>		<b>D646 x2</b>
	<b>C353 x2</b>		<b>A531 x3</b>		<b>D002 x4</b>		<b>D647 x2</b>
	<b>C354 x2</b>		<b>D685 x2</b>		<b>D677 x4</b>		<b>D655 x1</b>
	<b>D687 x2</b>		<b>D657 x5</b>		<b>D674 x1</b>		<b>D654 x1</b>
	<b>A053 x2</b>		<b>D664 x2</b>		<b>D667 x1</b>		<b>D654 x1</b>
	<b>A100 x2</b>		<b>D667 x1</b>		<b>D674 x1</b>		<b>D654 x1</b>
	<b>A103 x2</b>		<b>D667 x1</b>		<b>D674 x1</b>		<b>D654 x1</b>
	<b>A078 x2</b>		<b>D667 x1</b>		<b>D674 x1</b>		<b>D654 x1</b>
	<b>B031 x4</b>		<b>D674 x1</b>		<b>D674 x1</b>		<b>D654 x1</b>
	<b>D680 x2</b>		<b>D674 x1</b>		<b>D674 x1</b>		<b>D654 x1</b>
	<b>A545 x2</b>		<b>D667 x1</b>		<b>D674 x1</b>		<b>D654 x1</b>
	<b>D217 x2</b>		<b>D667 x1</b>		<b>D674 x1</b>		<b>D654 x1</b>
			<b>D667 x1</b>		<b>D674 x1</b>		<b>D654 x1</b>
			<b>D667 x1</b>		<b>D674 x1</b>		<b>D654 x1</b>
			<b>D667 x1</b>		<b>D674 x1</b>		<b>D654 x1</b>
			<b>D667 x1</b>		<b>D674 x1</b>		<b>D654 x1</b>
			<b>D667 x1</b>		<b>D674 x1</b>		<b>D654 x1</b>
			<b>D667 x1</b>		<b>D674 x1</b>		<b>D654 x1</b>
			<b>D667 x1</b>		<b>D674 x1</b>		<b>D654 x1</b>
			<b>D667 x1</b>		<b>D674 x1</b>		<b>D654 x1</b>
			<b>D667 x1</b>		<b>D674 x1</b>		<b>D654 x1</b>
			<b>D667 x1</b>		<b>D674 x1</b>		<b>D654 x1</b>
			<b>D667 x1</b>		<b>D674 x1</b>		<b>D654 x1</b>
			<b>D667 x1</b>		<b>D674 x1</b>		<b>D654 x1</b>
			<b>D667 x1</b>		<b>D674 x1</b>		<b>D654 x1</b>
			<b>D667 x1</b>		<b>D674 x1</b>		<b>D654 x1</b>
			<b>D667 x1</b>		<b>D674 x1</b>		<b>D654 x1</b>
			<b>D667 x1</b>		<b>D674 x1</b>		<b>D654 x1</b>
			<b>D667 x1</b>		<b>D674 x1</b>		<b>D654 x1</b>
			<b>D667 x1</b>		<b>D674 x1</b>		<b>D654 x1</b>
			<b>D667 x1</b>		<b>D674 x1</b>		<b>D654 x1</b>
			<b>D667 x1</b>		<b>D674 x1</b>		<b>D654 x1</b>
			<b>D667 x1</b>		<b>D674 x1</b>		<b>D654 x1</b>
			<b>D667 x1</b>		<b>D674 x1</b>		<b>D654 x1</b>
			<b>D667 x1</b>		<b>D674 x1</b>		<b>D654 x1</b>
			<b>D667 x1</b>		<b>D674 x1</b>		<b>D654 x1</b>
			<b>D667 x1</b>		<b>D674 x1</b>		<b>D654 x1</b>
			<b>D667 x1</b>		<b>D674 x1</b>		<b>D654 x1</b>
			<b>D667 x1</b>		<b>D674 x1</b>		<b>D654 x1</b>
			<b>D667 x1</b>		<b>D674 x1</b>		<b>D654 x1</b>
			<b>D667 x1</b>		<b>D674 x1</b>		<b>D654 x1</b>
			<b>D667 x1</b>		<b>D674 x1</b>		<b>D654 x1</b>
			<b>D667 x1</b>		<b>D674 x1</b>		<b>D654 x1</b>
			<b>D667 x1</b>		<b>D674 x1</b>		<b>D654 x1</b>
			<b>D667 x1</b>		<b>D674 x1</b>		<b>D654 x1</b>
			<b>D667 x1</b>		<b>D674 x1</b>		<b>D654 x1</b>
			<b>D667 x1</b>		<b>D674 x1</b>		<b>D654 x1</b>
			<b>D667 x1</b>		<b>D674 x1</b>		<b>D654 x1</b>
			<b>D667 x1</b>		<b>D674 x1</b>		<b>D654 x1</b>
			<b>D667 x1</b>		<b>D674 x1</b>		<b>D654 x1</b>
			<b>D667 x1</b>		<b>D674 x1</b>		<b>D654 x1</b>
			<b>D667 x1</b>		<b>D674 x1</b>		<b>D654 x1</b>
			<b>D667 x1</b>		<b>D674 x1</b>		<b>D654 x1</b>
			<b>D667 x1</b>		<b>D674 x1</b>		<b>D654 x1</b>
			<b>D667 x1</b>		<b>D674 x1</b>		<b>D654 x1</b>
			<b>D667 x1</b>		<b>D674 x1</b>		<b>D654 x1</b>
			<b>D667 x1</b>		<b>D674 x1</b>		<b>D654 x1</b>
			<b>D667 x1</b>		<b>D674 x1</b>		<b>D654 x1</b>
			<b>D667 x1</b>		<b>D674 x1</b>		<b>D654 x1</b>
			<b>D667 x1</b>		<b>D674 x1</b>		<b>D654 x1</b>
			<b>D667 x1</b>		<b>D674 x1</b>		<b>D654 x1</b>
			<b>D667 x1</b>		<b>D674 x1</b>		<b>D654 x1</b>
			<b>D667 x1</b>		<b>D674 x1</b>		<b>D654 x1</b>
			<b>D667 x1</b>		<b>D674 x1</b>		<b>D654 x1</b>
			<b>D667 x1</b>		<b>D674 x1</b>		<b>D654 x1</b>
			<b>D667 x1</b>		<b>D674 x1</b>		<b>D654 x1</b>
			<b>D667 x1</b>		<b>D674 x1</b>		<b>D654 x1</b>
			<b>D667 x1</b>		<b>D674 x1</b>		<b>D654 x1</b>
			<b>D667 x1</b>		<b>D674 x1</b>		<b>D654 x1</b>
			<b>D667 x1</b>		<b>D674 x1</b>		<b>D654 x1</b>
			<b>D667 x1</b>		<b>D674 x1</b>		<b>D654 x1</b>
			<b>D667 x1</b>		<b>D674 x1</b>		<b>D654 x1</b>
			<b>D667 x1</b>		<b>D674 x1</b>		<b>D654 x1</b>
			<b>D667 x1</b>		<b>D674 x1</b>		<b>D654 x1</b>
			<b>D667 x1</b>		<b>D674 x1</b>		<b>D654 x1</b>
			<b>D667 x1</b>		<b>D674 x1</b>		<b>D654 x1</b>
			<b>D667 x1</b>		<b>D674 x1</b>		<b>D654 x1</b>
			<b>D667 x1</b>		<b>D674 x1</b>		<b>D654 x1</b>
			<b>D667 x1</b>		<b>D674 x1</b>		<b>D654 x1</b>
			<b>D667 x1</b>		<b>D674 x1</b>		<b>D654 x1</b>
			<b>D667 x1</b>		<b>D674 x1</b>		<b>D654 x1</b>
			<b>D667 x1</b>		<b>D674 x1</b>		<b>D654 x1</b>
			<b>D667 x1</b>		<b>D674 x1</b>		<b>D654 x1</b>
			<b>D667 x1</b>		<b>D674 x1</b>		<b>D654 x1</b>
			<b>D667 x1</b>		<b>D674 x1</b>		<b>D654 x1</b>
			<b>D667 x1</b>		<b>D674 x1</b>		<b>D654 x1</b>
			<b>D667 x1</b>		<b>D674 x1</b>		<b>D654 x1</b>
			<b>D667 x1</b>		<b>D674 x1</b>		<b>D654 x1</b>
			<b>D667 x1</b>		<b>D674 x1</b>		<b>D654 x1</b>
			<b>D667 x1</b>		<b>D674 x1</b>		<b>D654 x1</b>
			<b>D667 x1</b>		<b>D674 x1</b>		<b>D654 x1</b>
			<b>D667 x1</b>		<b>D674 x1</b>		<b>D654 x1</b>
			<b>D667 x1</b>		<b>D674 x1</b>		<b>D654 x1</b>
			<b>D667 x1</b>		<b>D674 x1</b>		<b>D654 x1</b>
			<b>D667 x1</b>		<b>D674 x1</b>		<b>D654 x1</b>
			<b>D667 x1</b>		<b>D674 x1</b>		<b>D654 x1</b>
			<b>D667 x1</b>		<b>D674 x1</b>		<b>D654 x1</b>
			<b>D667 x1</b>		<b>D674 x1</b>		<b>D654 x1</b>
			<b>D667 x1</b>		<b>D674 x1</b>		<b>D654 x1</b>
			<b>D667 x1</b>		<b>D674 x1</b>		<b>D654 x1</b>
			<b>D667 x1</b>		<b>D674 x1</b>		





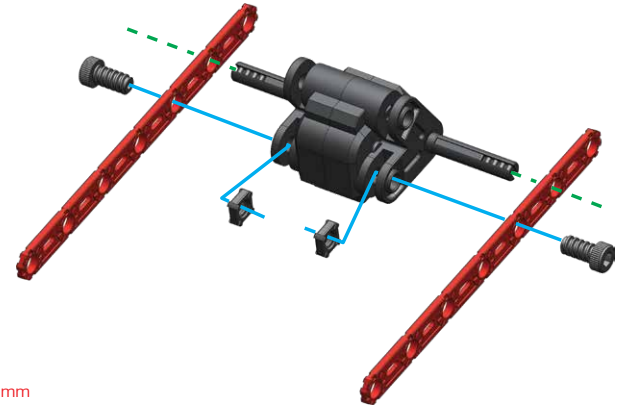

1

-  x 2
-  x 2
-  x 2
-  x 1



2

-  x 2
-  x 2
-  x 2

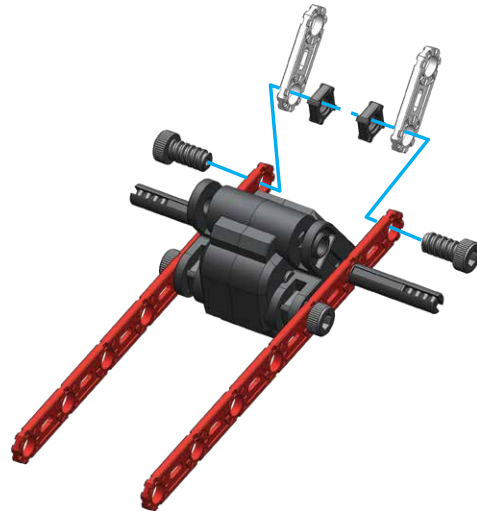

3

- x 2
- x 2
- x 2

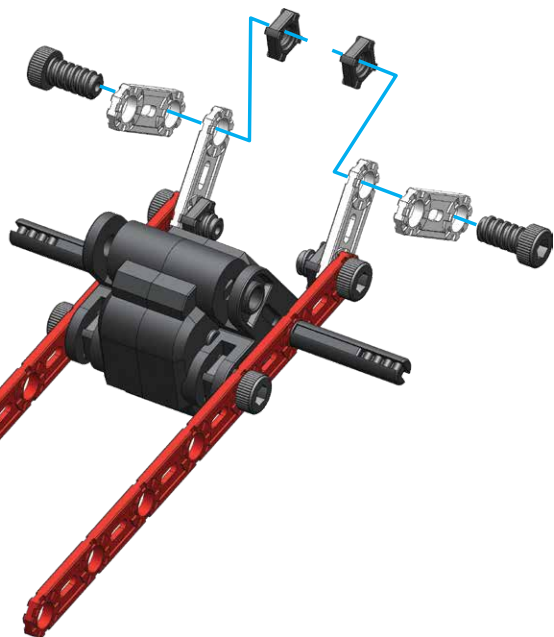
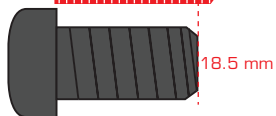





6

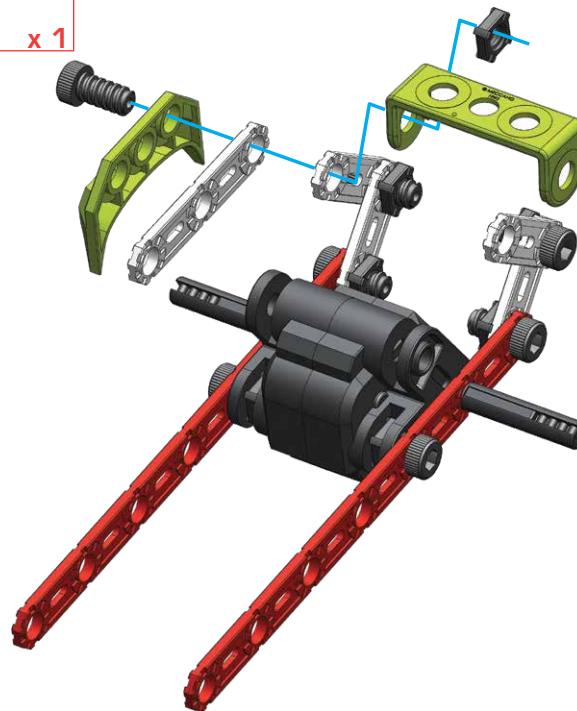

4

- x 1
- x 1
- x 1
- x 1
- x 1



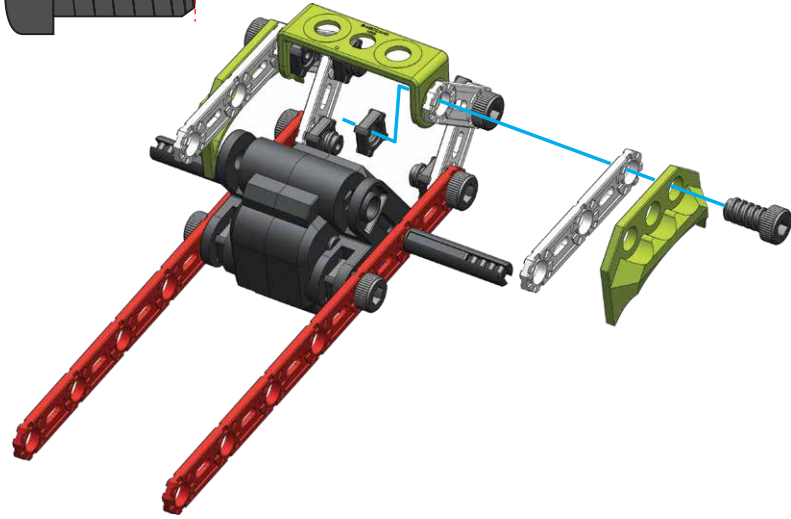
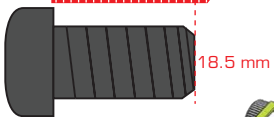

- 5**
-  x 1
  -  x 1
  -  x 1
  -  x 1

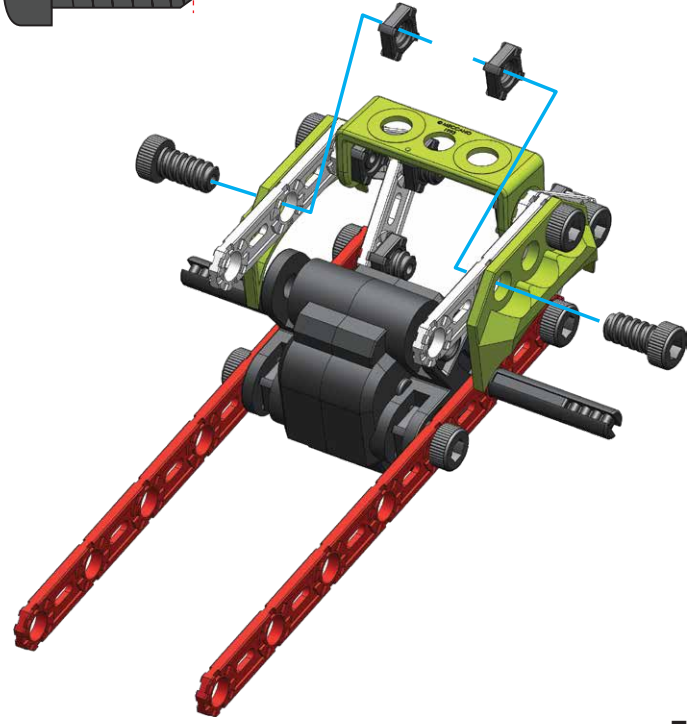
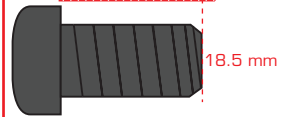

- 6**
-  x 2
  -  x 2



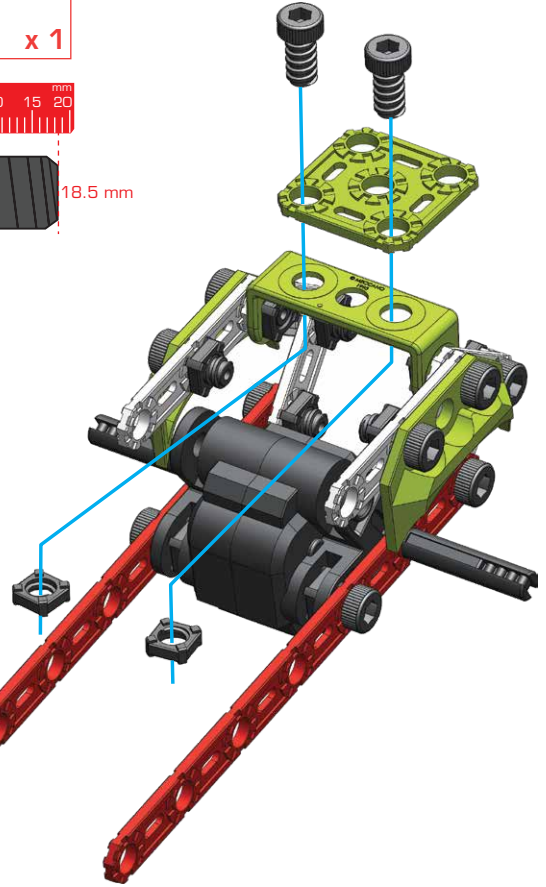

**7**

-  x 2
-  x 2
-  x 1





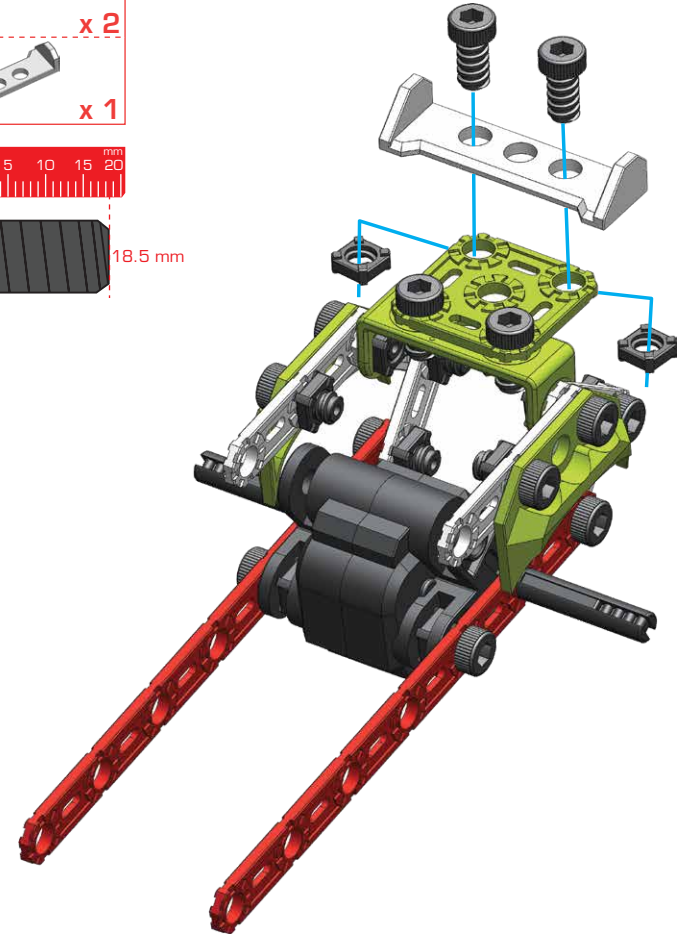

**8**

-  x 2
-  x 2
-  x 1





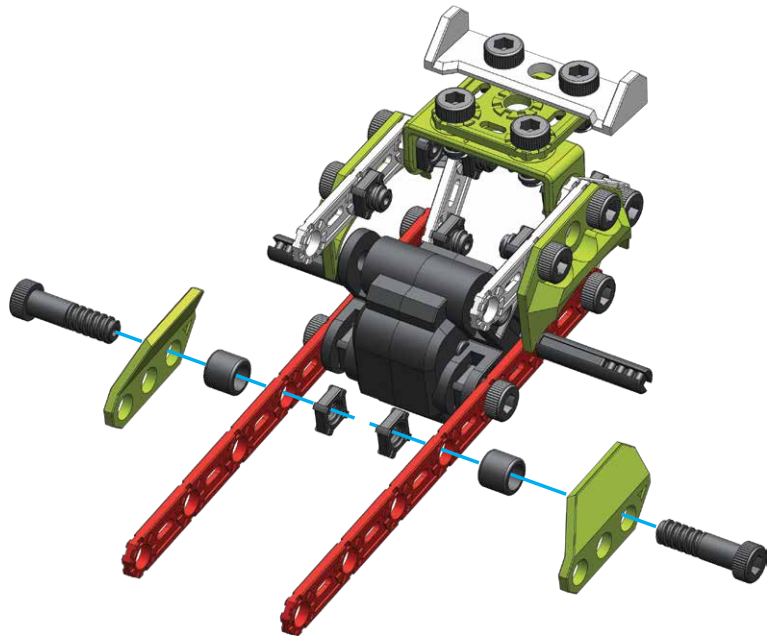
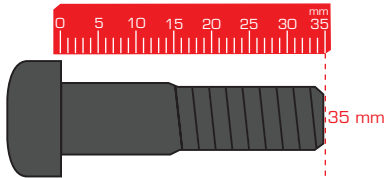

**9**

-  x 2
-  x 2
-  x 2
-  x 1
-  x 1





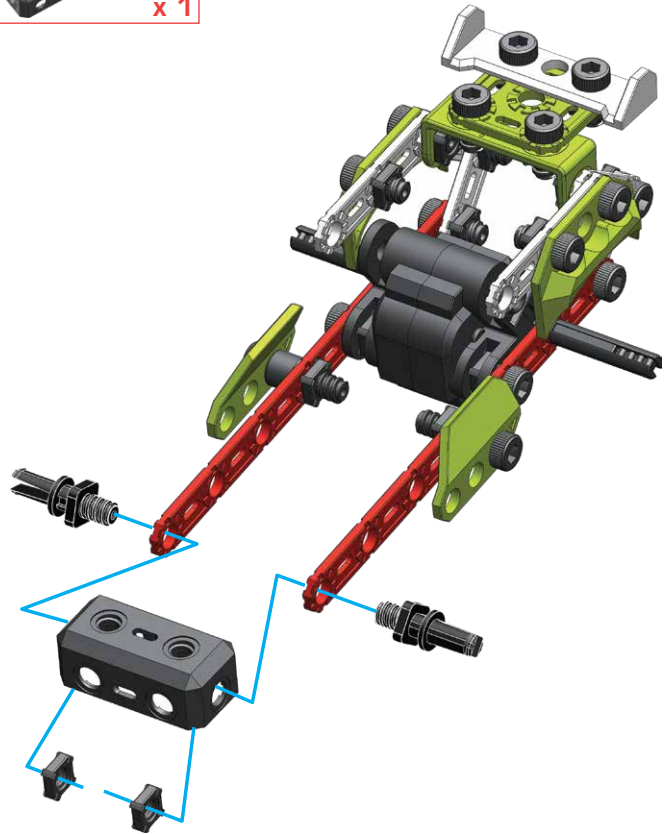

**10**

-  x 2
-  x 2
-  x 1



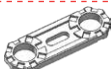

**11**

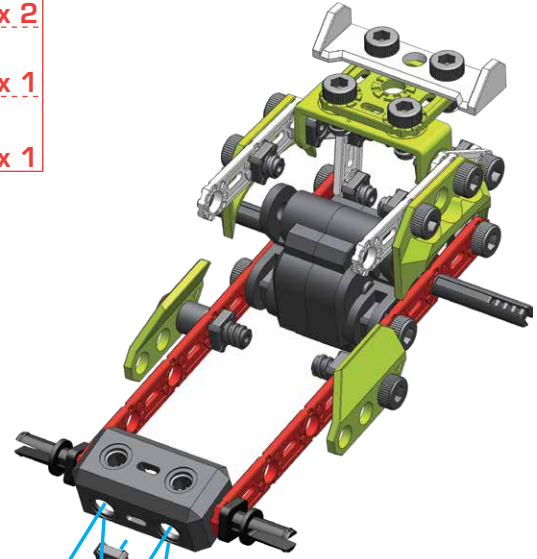
-  x 2
-  x 2
-  x 2
-  x 1
-  x 1





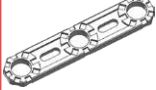

10

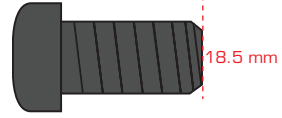
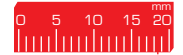
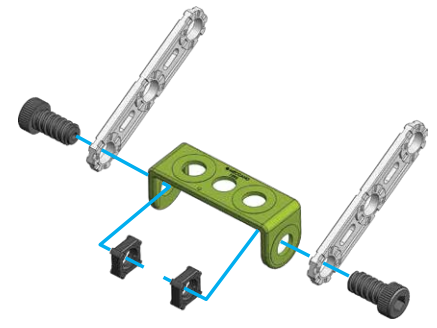
**12**

-  x 2
-  x 2
-  x 1
-  x 2



**13**

-  x 1
-  x 1
-  x 2
-  x 1

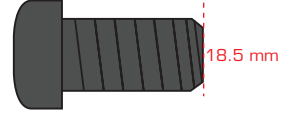
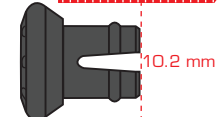
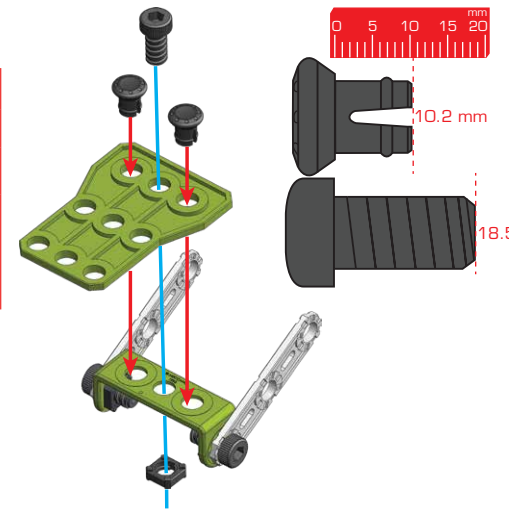

**14** 11+13

 x 2

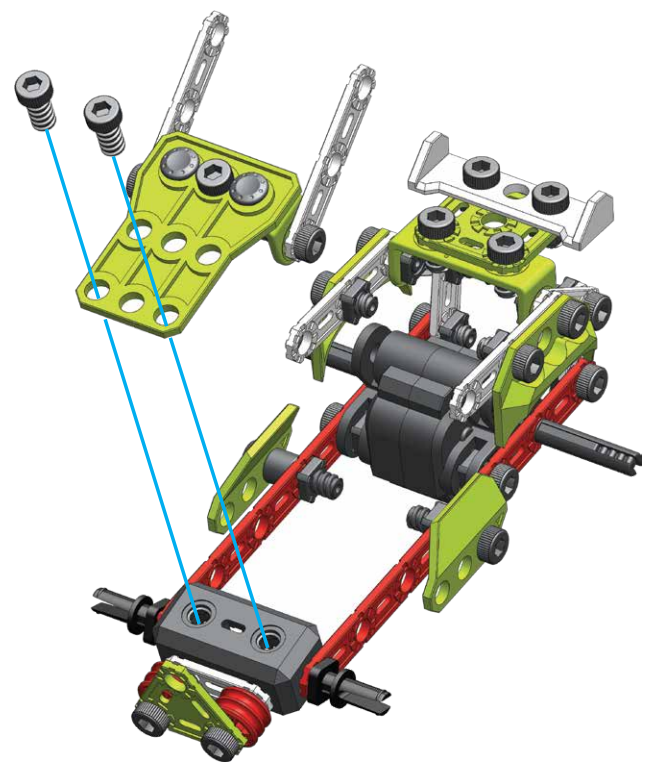
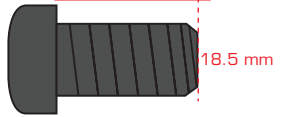

**15**

 x 2

 x 2

 x 1

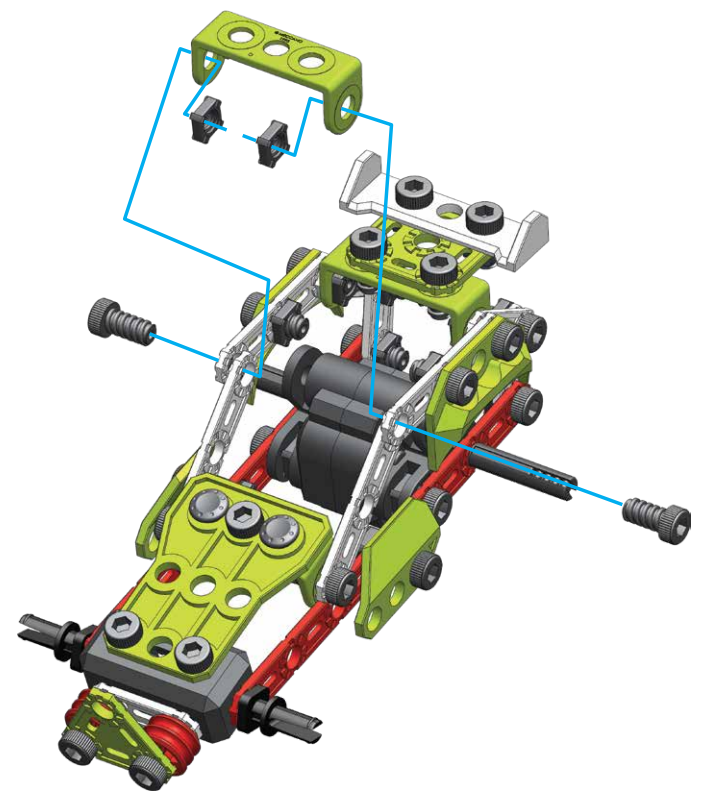
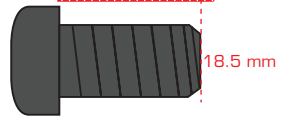

16

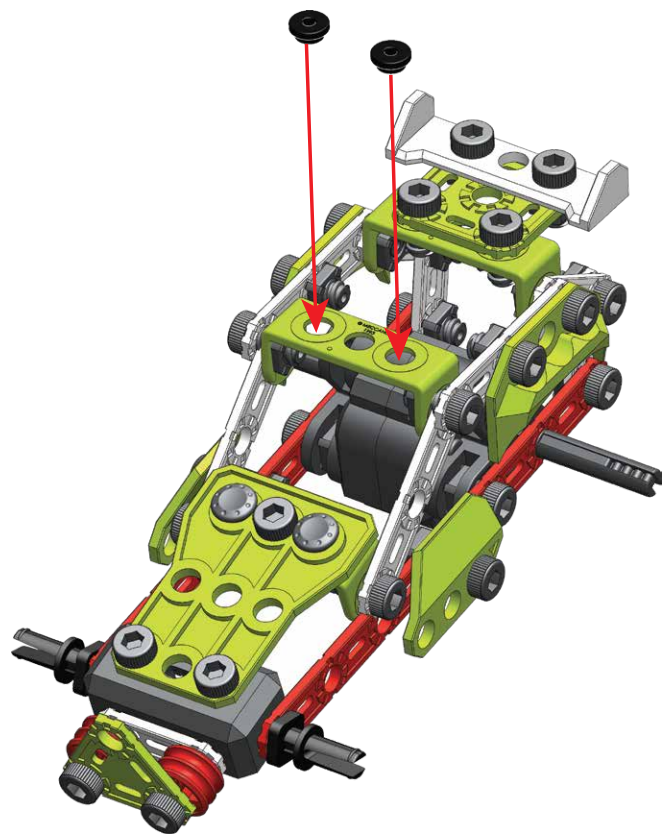

17

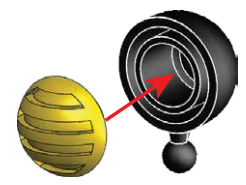
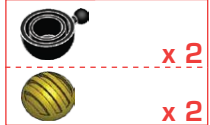

18 16+17

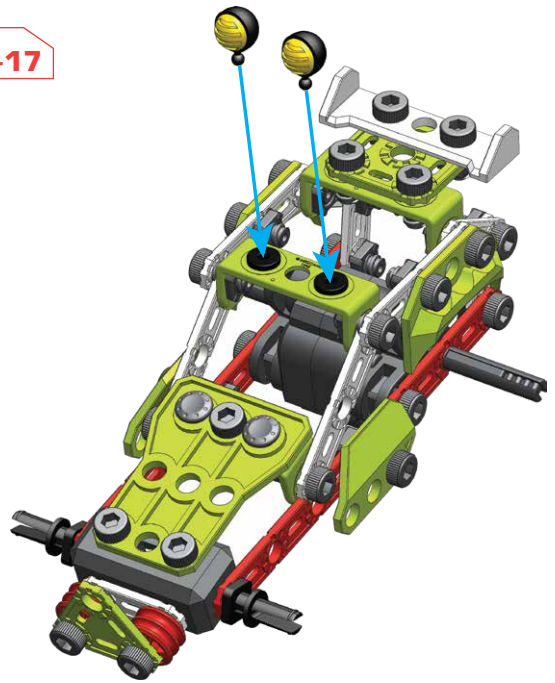

19

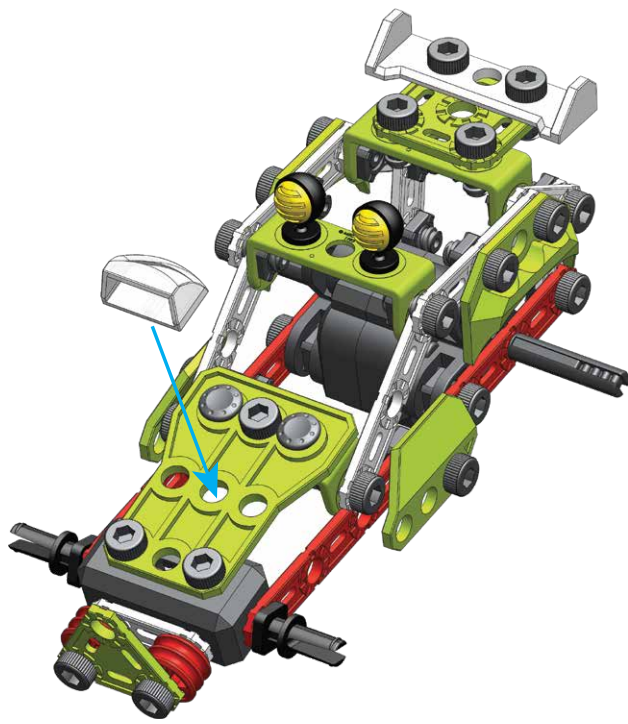

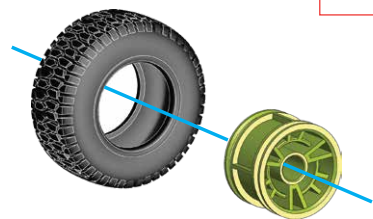

20

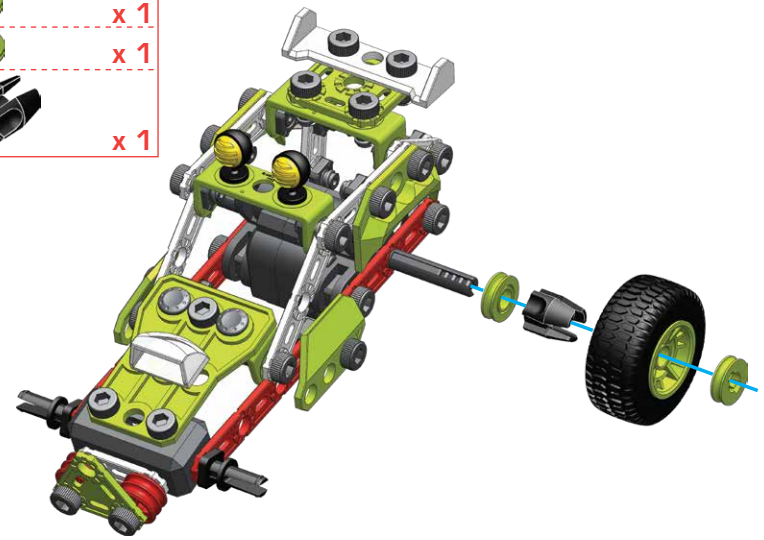

21 19+20





<b>22</b>	<b>20+21</b>
	x 1
	x 1
	x 1

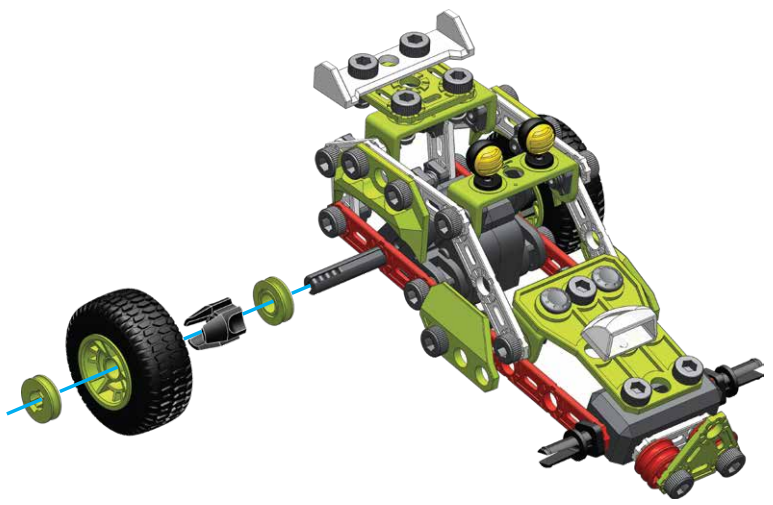
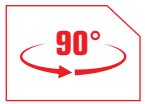

**23** 20+22

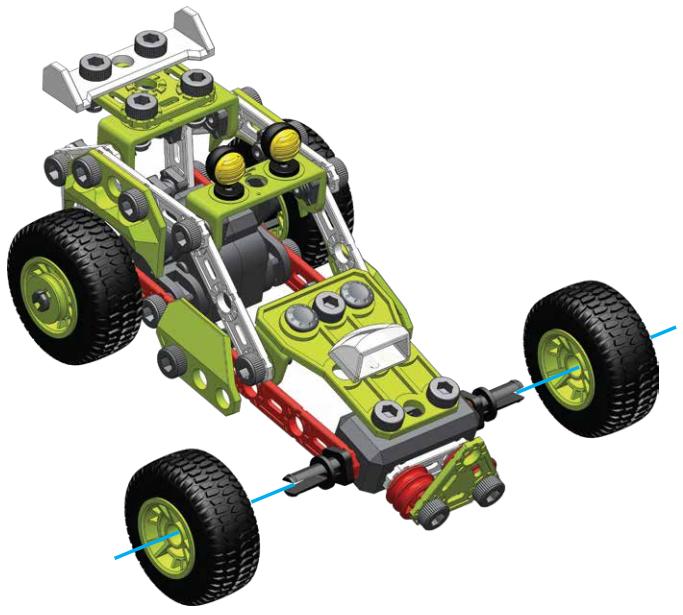



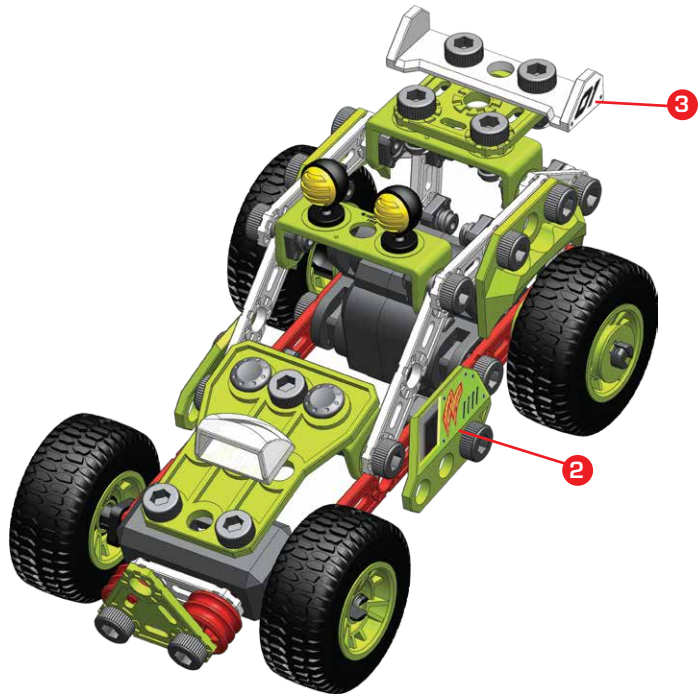
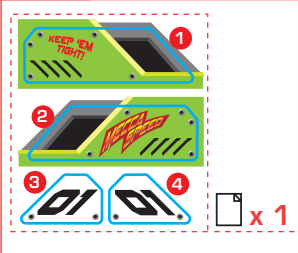

24







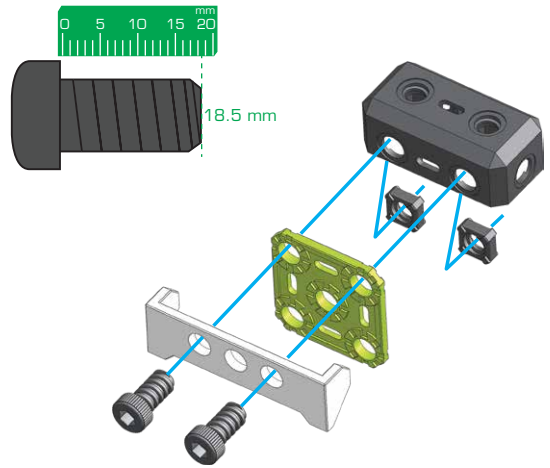

**1**

-  x 2
-  x 2
-  x 1
-  x 1
-  x 1



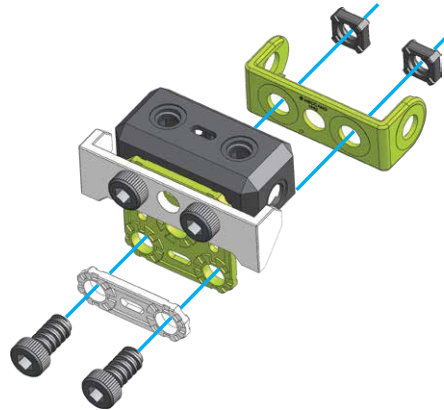
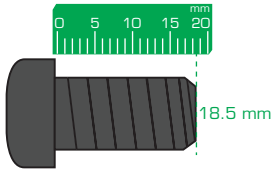

**2**

-  x 2
-  x 2
-  x 1
-  x 1

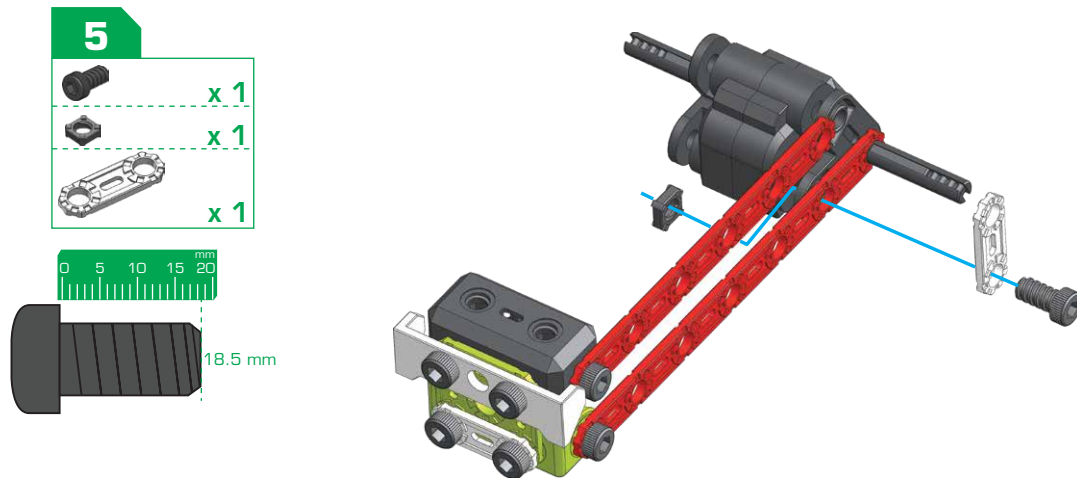
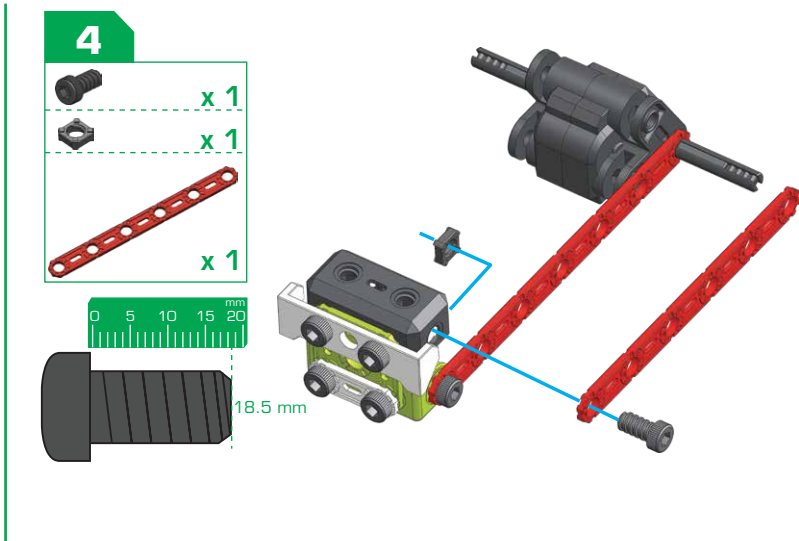
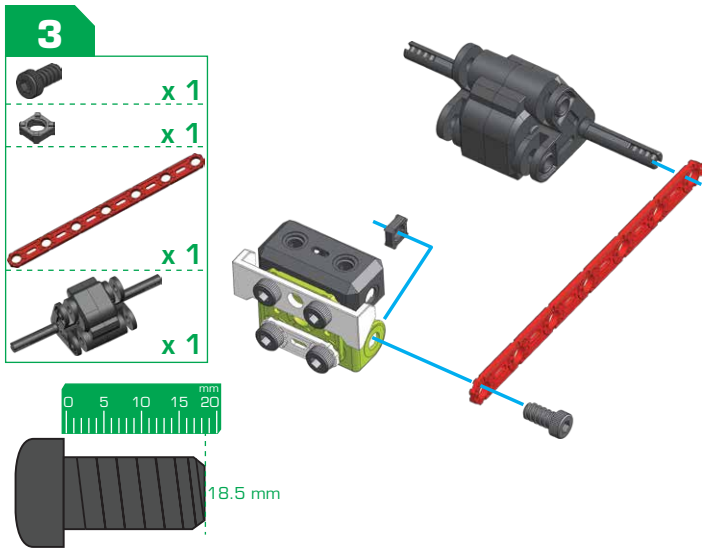



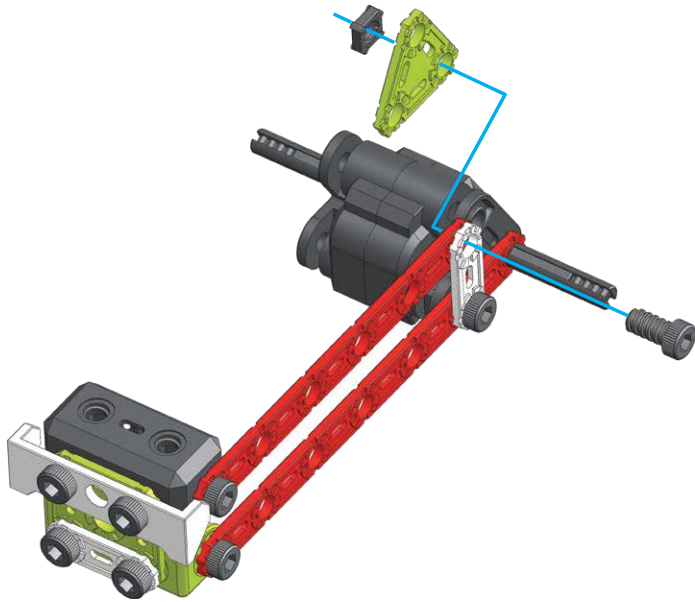

**6**

-  x 1
-  x 1
-  x 1



**7**

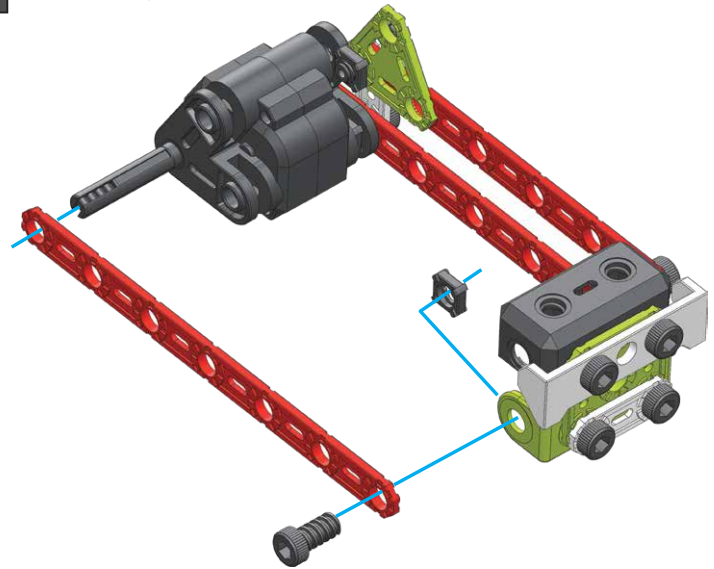
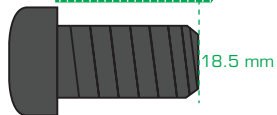

-  x 1
-  x 1
-  x 1



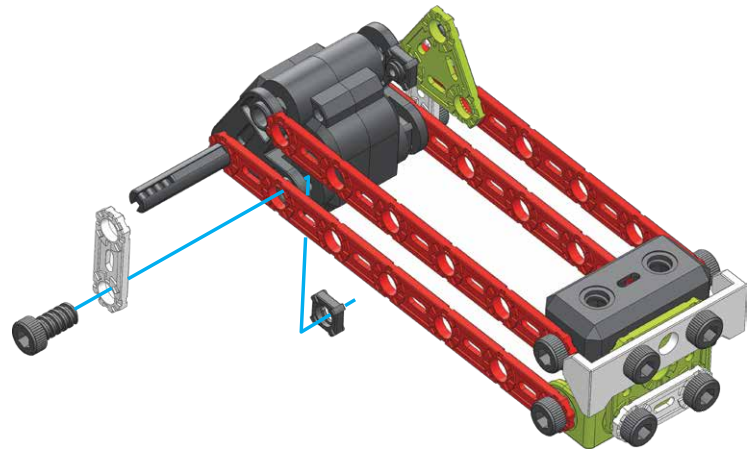
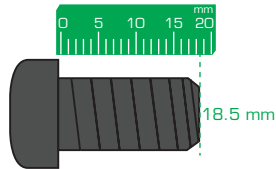
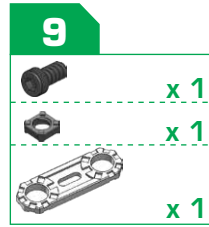
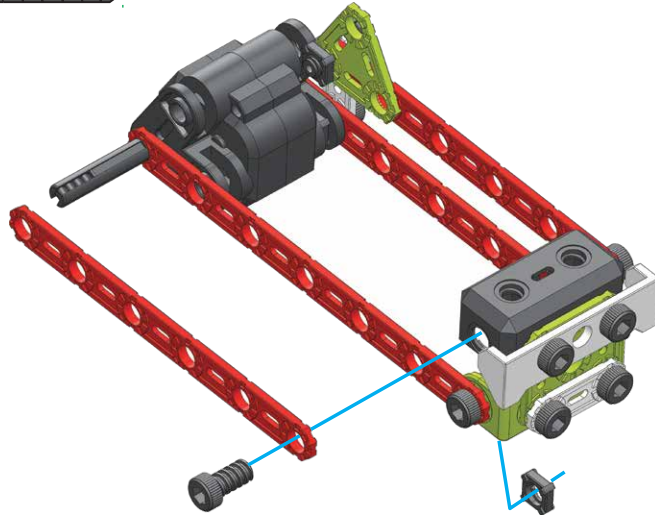
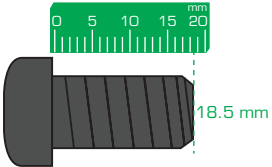
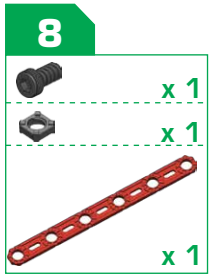



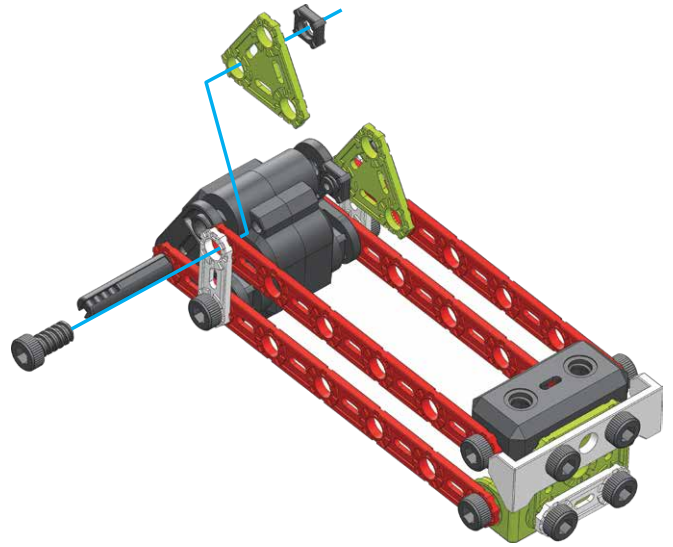
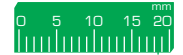

# 10

-  x 1
-  x 1
-  x 1



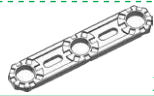

# 11

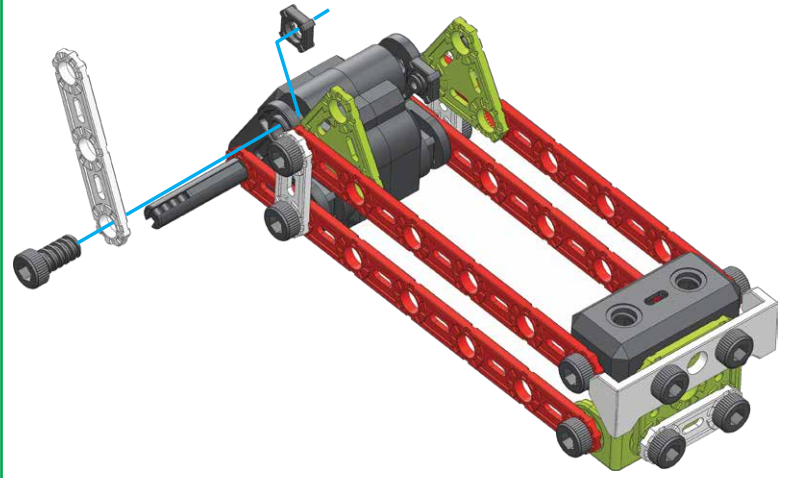
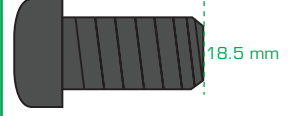
-  x 1
-  x 1
-  x 1





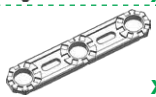

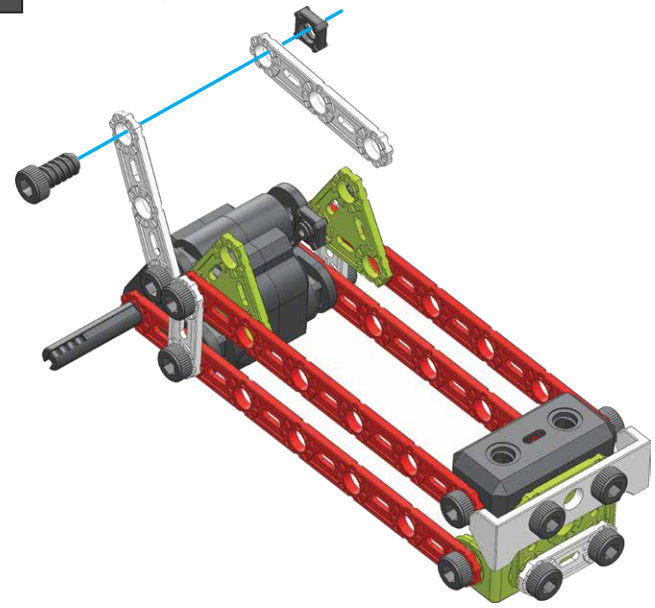
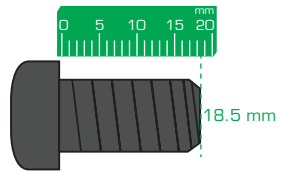
**12**

-  x 1
-  x 1
-  x 1



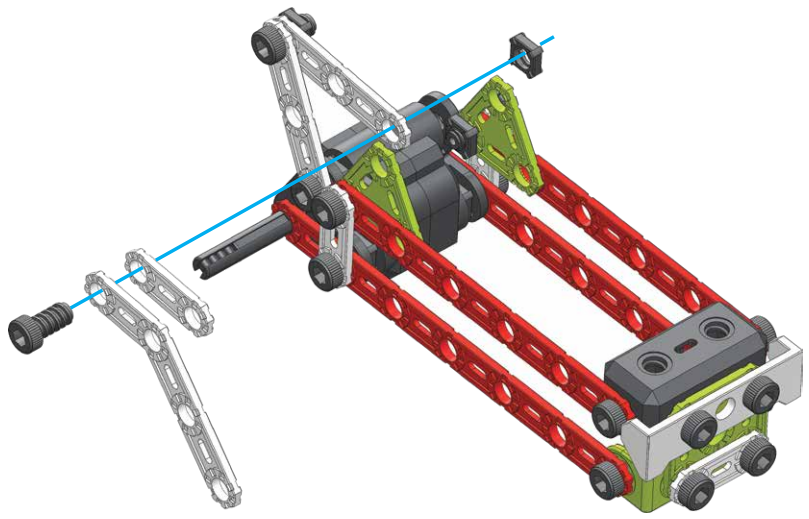
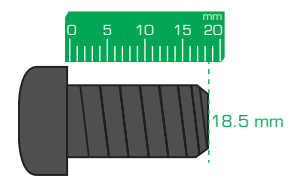

**13**

-  x 1
-  x 1
-  x 1
-  x 1



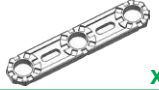

# 14

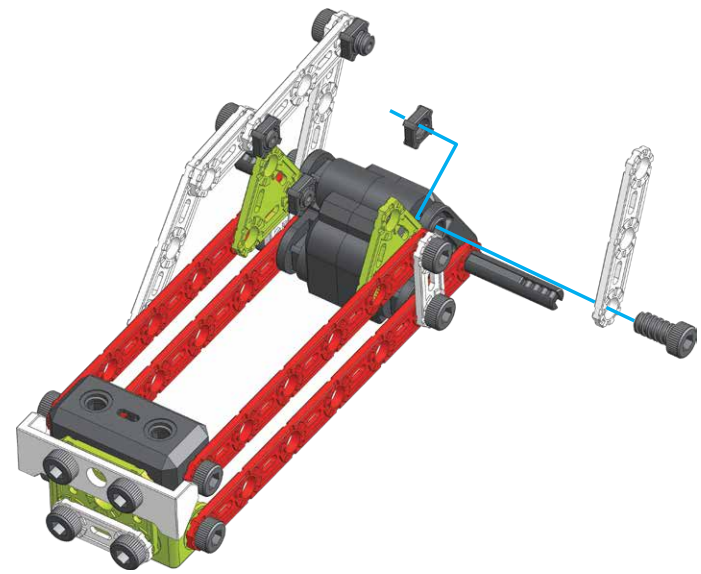
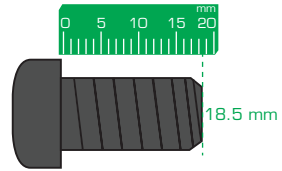
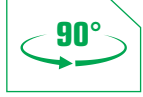
-  x 1
-  x 1
-  x 1



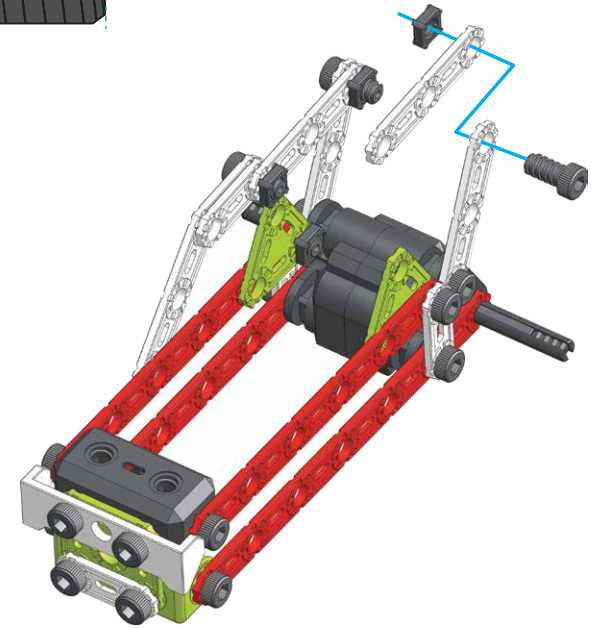
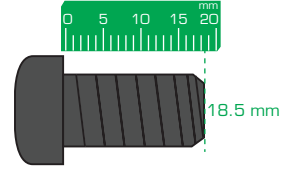

# 15

-  x 1
-  x 1
-  x 1

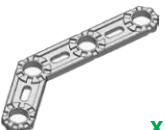

# 16

-  x 1
-  x 1
-  x 1
-  x 1

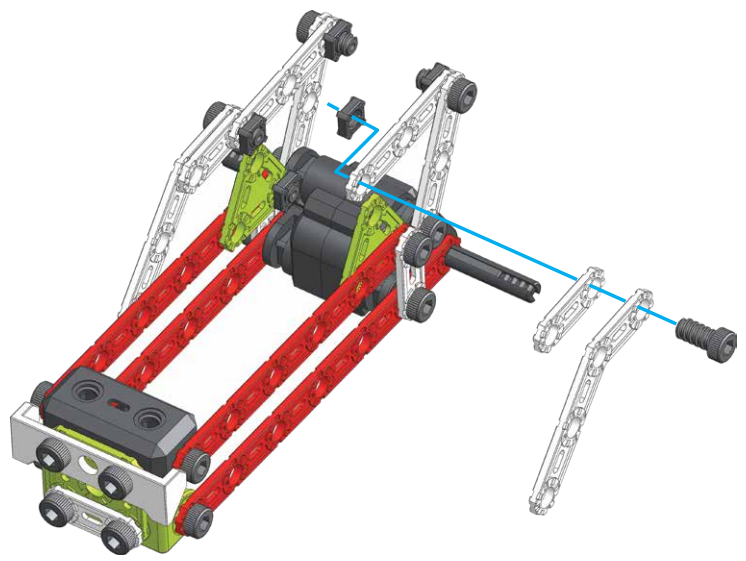
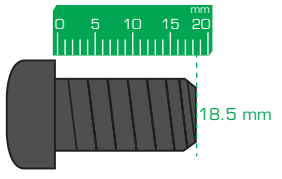

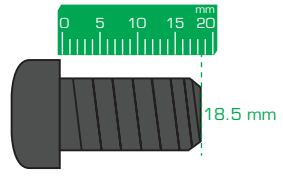

# 17

-  x 2
-  x 2





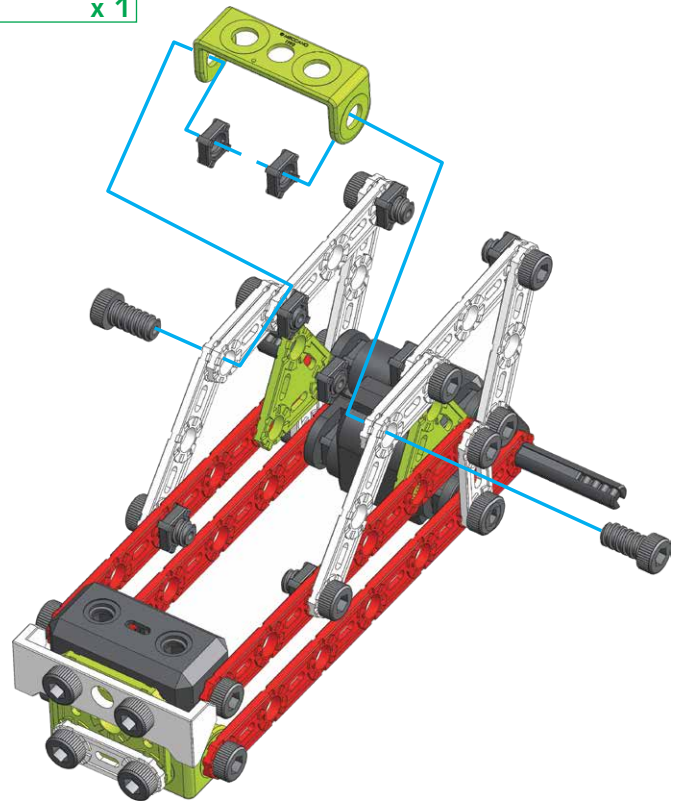
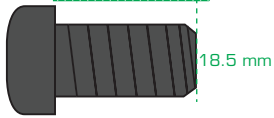

# 18

-  x 2
-  x 2
-  x 1



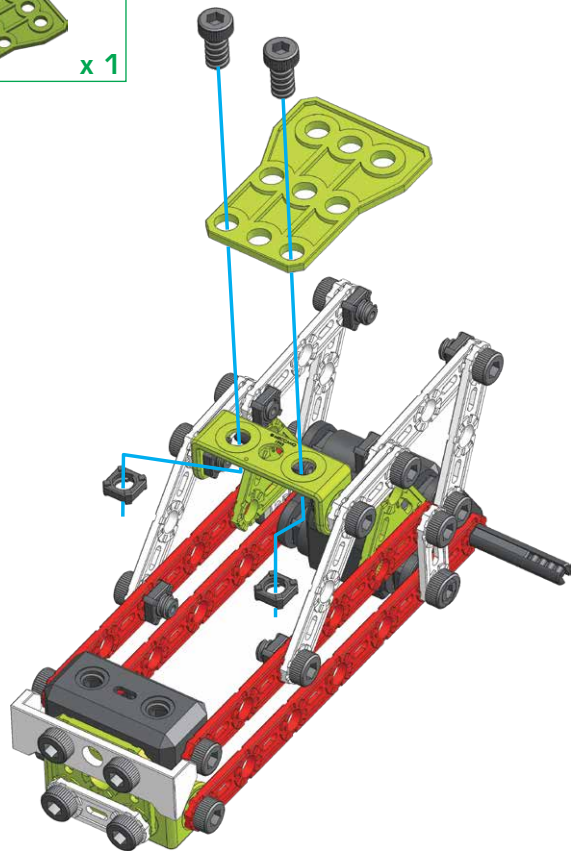
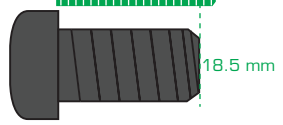
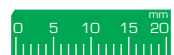

# 19

-  x 2
-  x 2
-  x 1





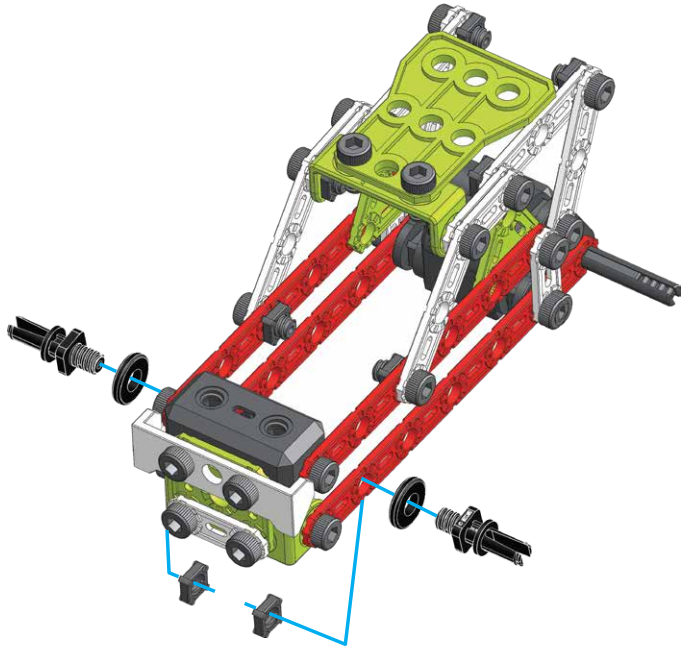

# 20

-  x 2
-  x 2
-  x 2





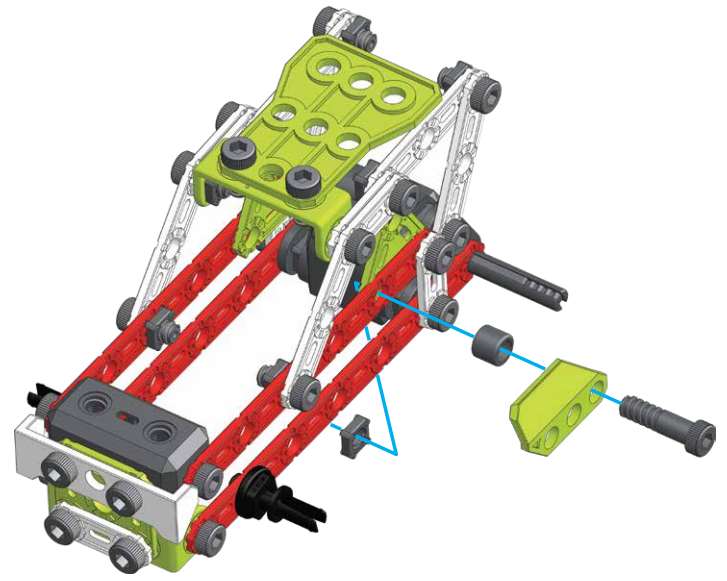
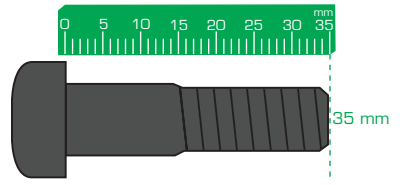

# 21

-  x 1
-  x 1
-  x 1
-  x 1



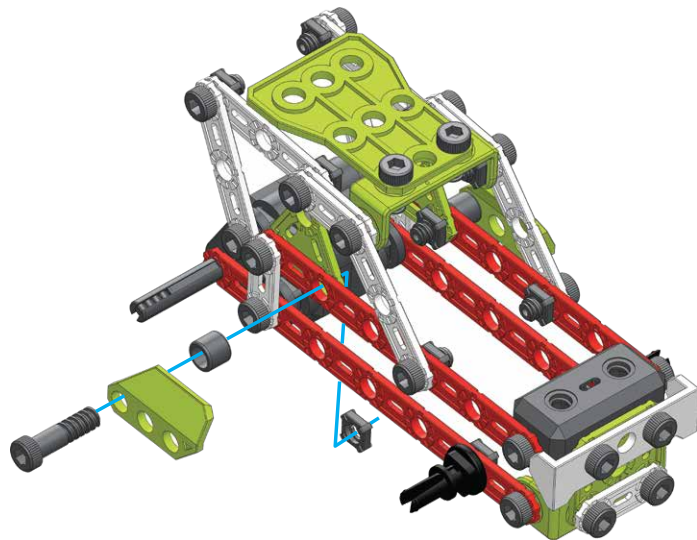
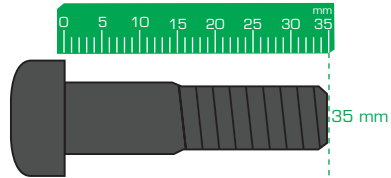

22

-  x 1
-  x 1
-  x 1
-  x 1



23

-  x 1
-  x 1
-  x 1
-  x 1

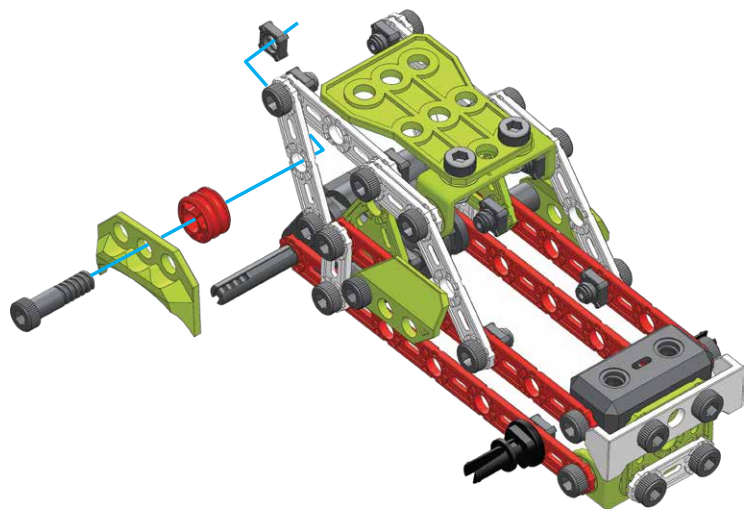
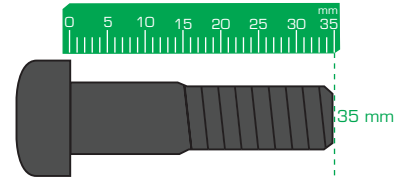

24

-  x 1
-  x 1
-  x 1
-  x 1

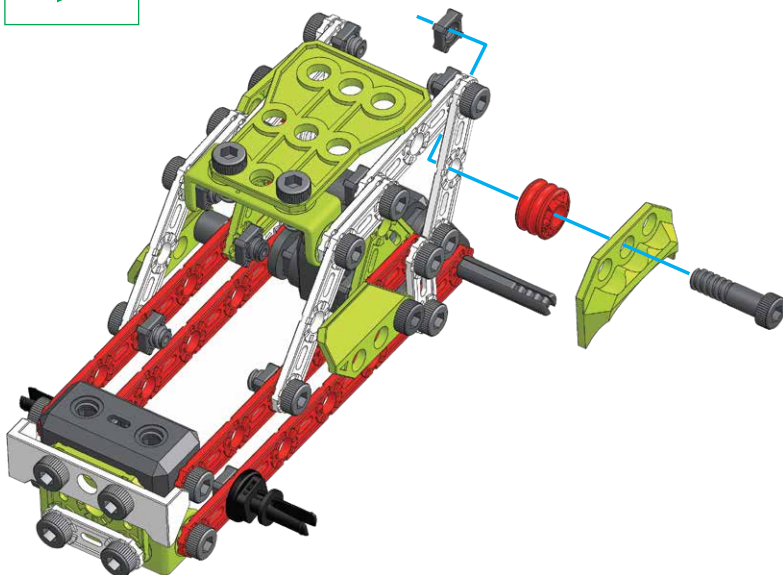
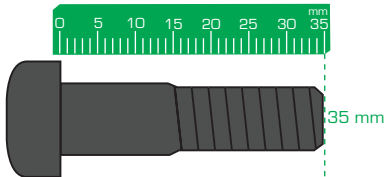

25

-  x 1

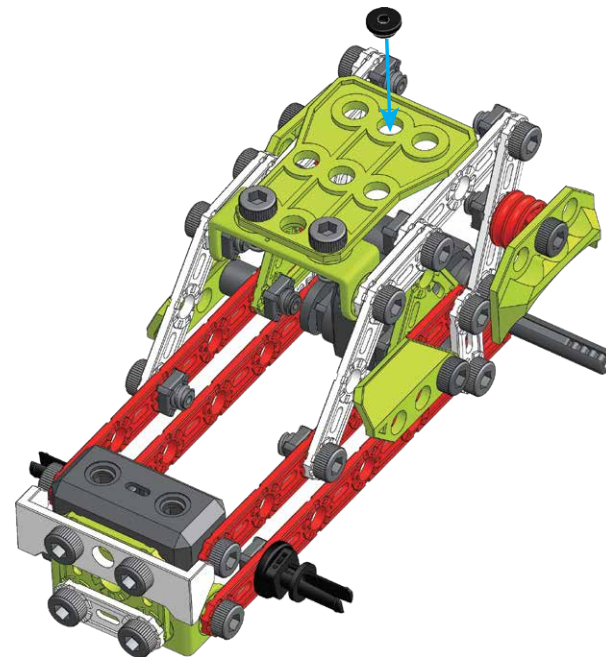

26



27

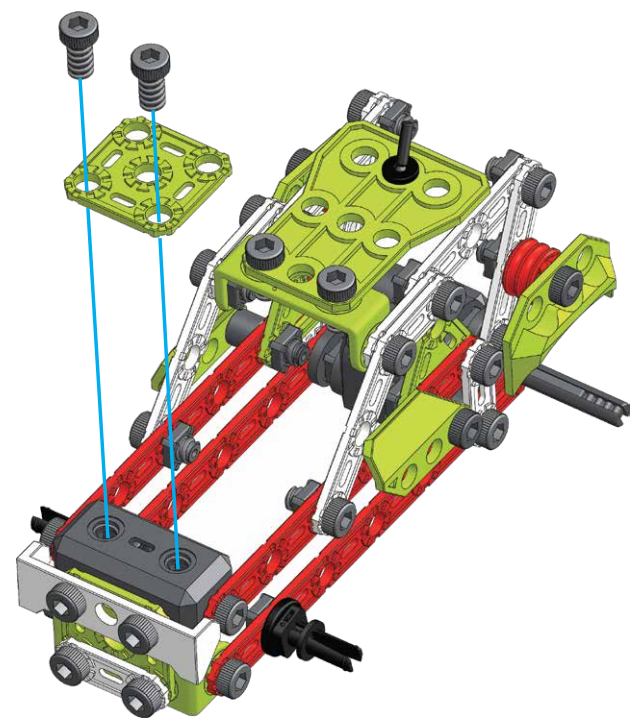
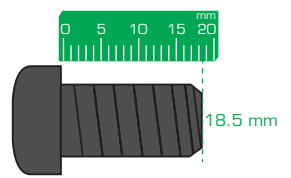
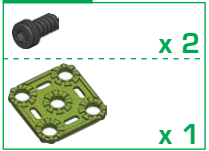



**28**

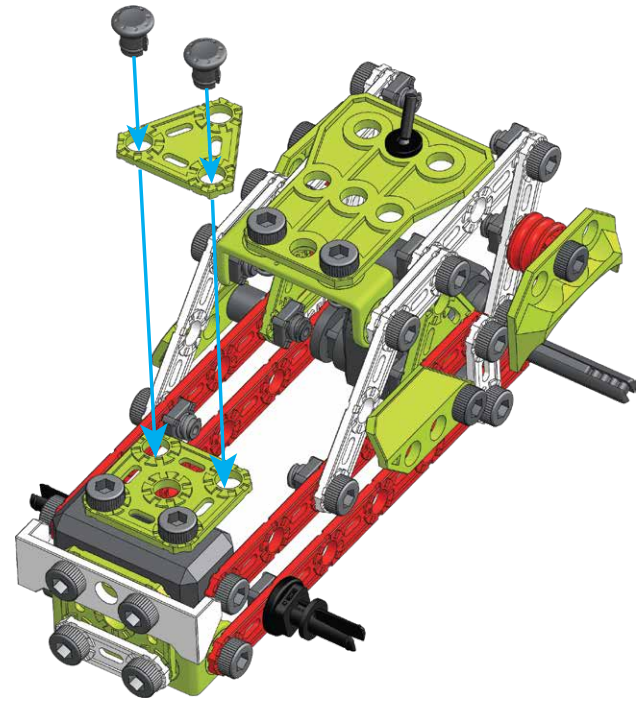
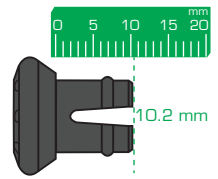
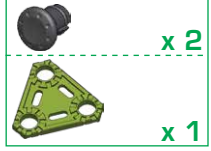

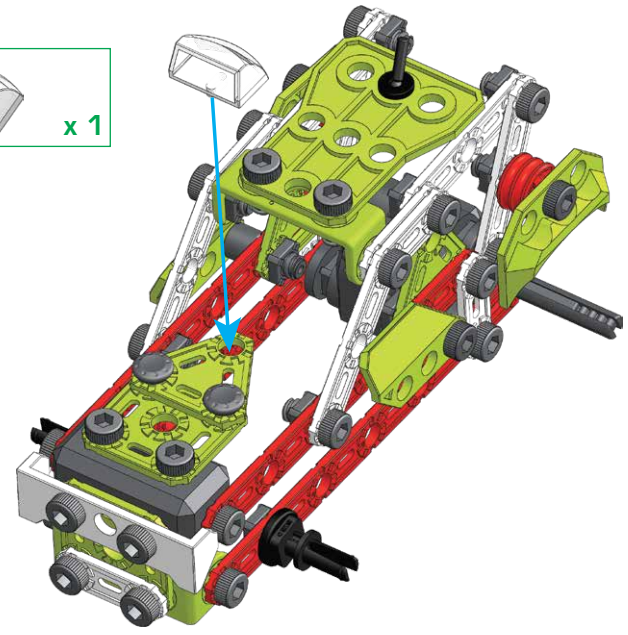
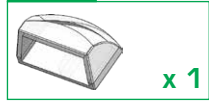

**29**

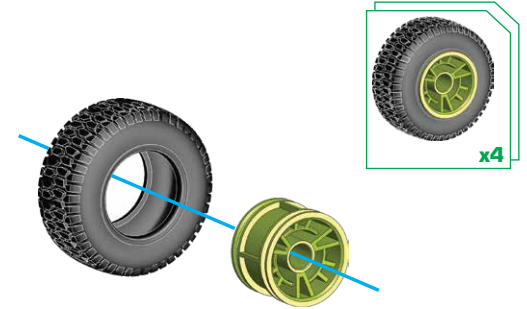
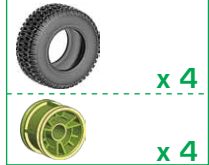

**30**



**31** 29+30

-  x 2
-  x 2
-  x 2

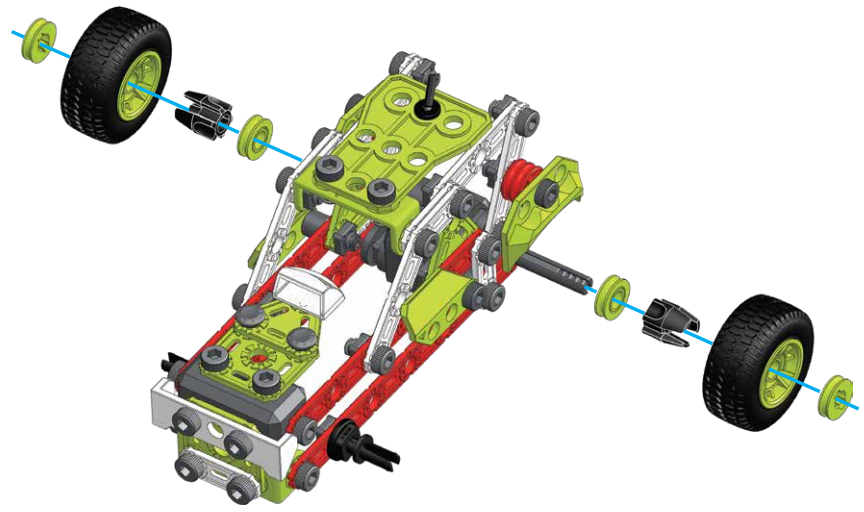

**32** 30+31



33

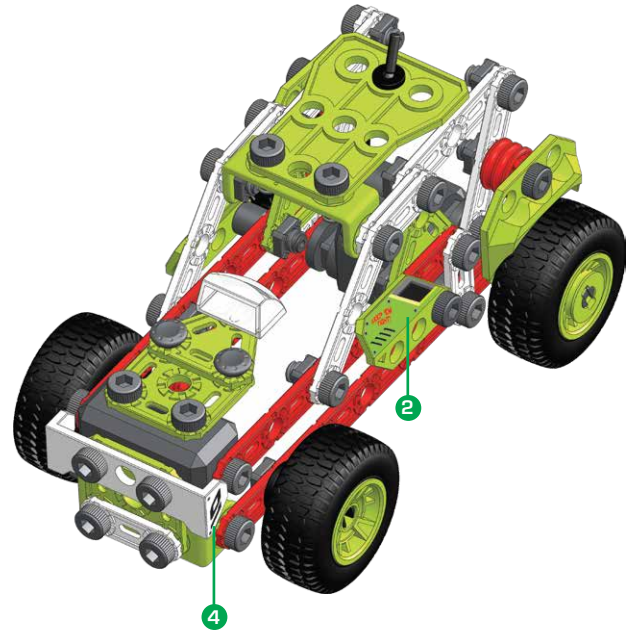
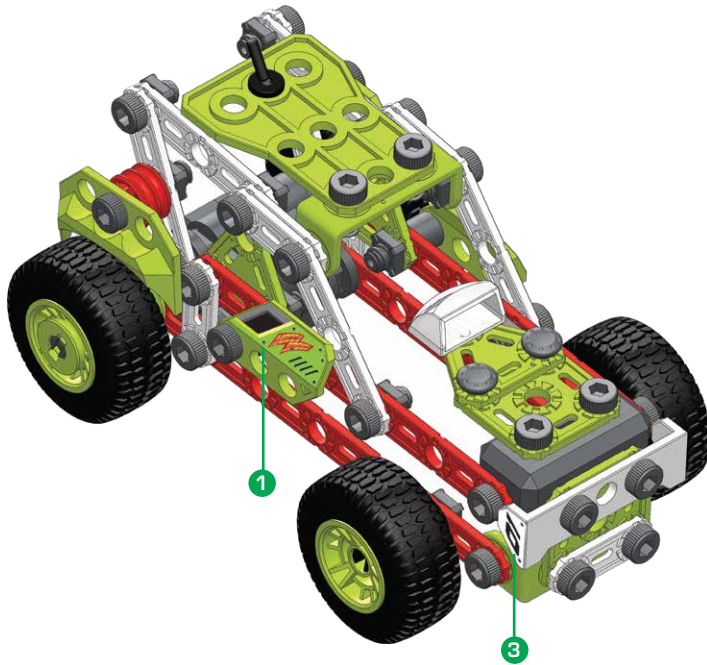
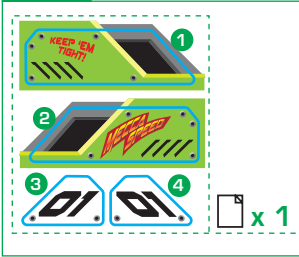

Запишите указанные на упаковке адреса и номера телефонов, чтобы у вас была возможность связаться с нами. Рекомендуется присмотр взрослых.

TM & © 2020 MECCANO for packaging, instructions and models built with this set. © MECCANO is an exclusive trademark of MECCANO. Spin Master logo is a trademark of Spin Master Ltd. All rights reserved. / TM & © 2020 MECCANO pour l'emballage, les notices et modèles de ce coffret. © MECCANO est une marque de commerce exclusive de MECCANO. Le logo de Spin Master est une marque de commerce de Spin Master Ltd. Tous droits réservés.

Meccano reserves the right to discontinue the website [www.meccano.com](http://www.meccano.com) at any time. / Meccano se réserve le droit de supprimer le site Internet [www.meccano.com](http://www.meccano.com) à tout moment.

- ⚠ **WARNING:** CHOKING HAZARD – Small parts.
- ⚠ **ATTENTION !** DANGER D'ÉTOUFFEMENT – Contient de petits éléments.
- ⚠ **ADVERTENCIA:** PELIGRO DE ASFIXIA – Contiene piezas pequeñas.  
No conviene para niños menores de tres años.
- ⚠ **ACHTUNG:** ERSTICKUNGSGEFAHR – Kleinteile.
- ⚠ **WAARSCHUWING:** VERSTIKKINGSGEVAAR – Kleine onderdelen.
- ⚠ **AVVERTENZA:** RISCHIO DI SOFFOCAMENTO – Pezzi piccoli.
- ⚠ **ATENÇÃO:** PERIGO DE ASFIXIA – Peças pequenas.
- ⚠ **ПРЕДУПРЕЖДЕНИЕ!** ОПАСНОСТЬ УДУШЬЯ – Мелкие детали.



- ⚠ **OSTRZEŻENIE:** NIEBEZPIECZEŃSTWO ZADŁAWIENIA – Drobne elementy.
- ⚠ **UPOZORNĚNÍ:** NEBEZPEČÍ UDUŠENÍ – Obsahuje malé části.
- ⚠ **UPOZORNENIE:** NEBEZPEČENSTVO UDUSENIA – Obsahuje malé predmety.
- ⚠ **FIGYELMEZTETÉS:** FULLADÁSVESZÉLY – Apró alkatrészek.
- ⚠ **AVERTISMENT:** PERICOL DE ASFIXIERE – Piese mici.
- ⚠ **ΠΡΟΕΙΔΟΠΟΙΗΣΗ:** ΚΙΝΔΥΝΟΣ ΠΝΙΓΜΟΥ – Μικρά μέρη.
- ⚠ **UPOZORENJE:** OPASNOST OD GUŠENJA – Mali dijelovi.
- ⚠ **ВНИМАНИЕ:** ОПАСНОСТЬ ОТ ЗАДАВЯНЕ – Малки части.
- ⚠ **OPOZORILO:** NEVARNOST ZADUSITVE – Majhni deli.

**NORTH AMERICA • AMÉRIQUE DU NORD**  
1-800-622-8339, [customercare@spinmaster.com](mailto:customercare@spinmaster.com)

**UK** – 0800 206 1191, [serviceuk@spinmaster.com](mailto:serviceuk@spinmaster.com)

**IRELAND** – 1800 992 249

**FRANCE** – 0800 909 150, [servicefr@spinmaster.com](mailto:servicefr@spinmaster.com)

**AUSTRALIA** – 1800 316 982, [customercare@spinmaster.com](mailto:customercare@spinmaster.com)

**DEUTSCHLAND** – 00800 0101 0222, [Kundenservice@spinmaster.com](mailto:Kundenservice@spinmaster.com)

**SCHWEIZ** – 0800 561 350 • **ÖSTERREICH** – 0800 297 267

**NEDERLAND** – 0800 022 3683, [klantenservice@spinmaster.com](mailto:klantenservice@spinmaster.com)

**BELGIË/BELGIQUE** – 0800 77 688 • **LUXEMBOURG** – 800 2 8044

**ITALIA** – 800 788 532, [servizio@spinmaster.com](mailto:servizio@spinmaster.com)

**MÉXICO** – 01 800 9530147, [servicio@spinmaster.com](mailto:servicio@spinmaster.com)

**POLSKA** – 800080238, [poland@spinmaster.com](mailto:poland@spinmaster.com)

**ČESKÁ REPUBLIKA** – 800550530, [czechrepublic@spinmaster.com](mailto:czechrepublic@spinmaster.com)

**SLOVENSKO** – 0800232800, [slovakia@spinmaster.com](mailto:slovakia@spinmaster.com)

**MAGYARORSZÁG** – 080 100 052, [hungary@spinmaster.com](mailto:hungary@spinmaster.com)

**ROMÂNIA** – 0800400015, [romania@spinmaster.com](mailto:romania@spinmaster.com)

**РОССИЯ** – 88003013822, [russia@spinmaster.com](mailto:russia@spinmaster.com)

**WWW.SPINMASTER.COM**



Spin Master Ltd., 225 King Street West, Toronto ON M5V 3M2 Canada

Distributed in EU by / Distribué dans l'UE par Spin Master International B.V., Kingsfordweg 151, 1043 GR Amsterdam, The Netherlands

Imported by / Importé par Spin Master Australia Pty Ltd, Suite 101, Level 1, 18-24 Chandos Street, St Leonards, NSW 2065; ☎1800 316 982

Импортер: ООО «Спин Мастер РУС», Россия, Москва 117638 Одесская ул. 2, Бизнес-центр «Лотос», башня С, 10 эт. Тел.: 8 800 301 38 22

Изготовитель: Спин Мастер Лтд., 225 Кинг Стрит Вест, Торонто, ОН М5В 3М2 Канада ☎18006228339

[www.spinmaster.com](http://www.spinmaster.com)

[Meccano.363.avenue.de.Saint.Exupéry.62100.Calais.France](http://Meccano.363.avenue.de.Saint.Exupéry.62100.Calais.France)

**EAC**



T91877\_0002\_20121144\_GML\_ISW\_R1 (MEC\_Jnr\_Discoverydlxfeaturebx\_Car\_Fr\_S20)