









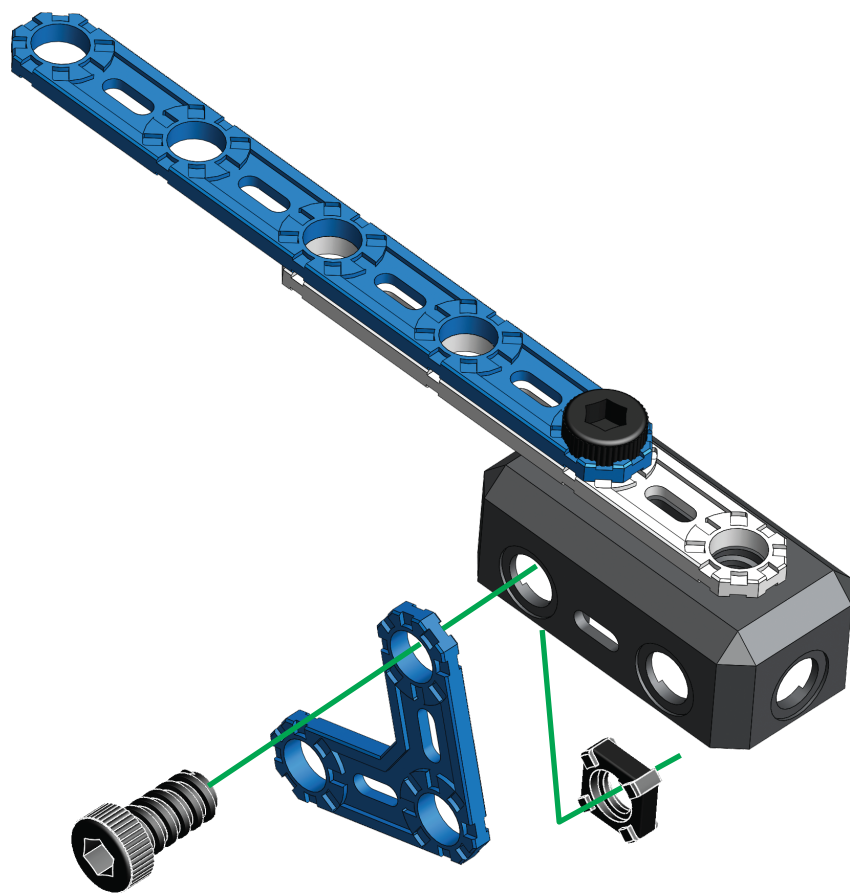
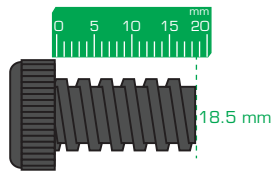

- 2**
-  x 1
  -  x 1
  -  x 1

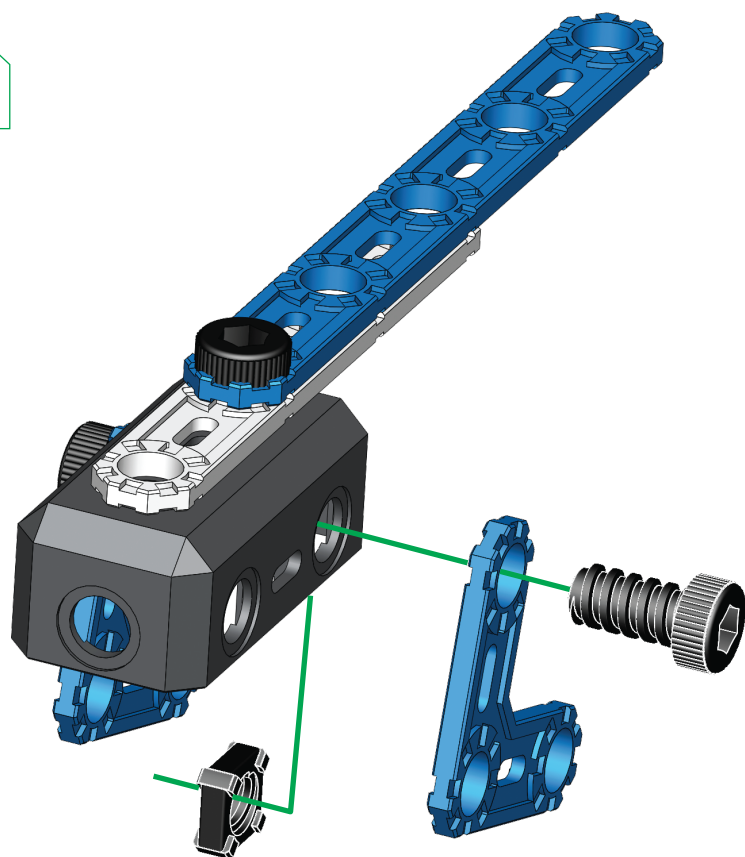
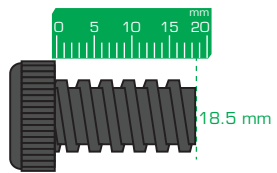

- 3**
-  x 1
  -  x 1
  -  x 1



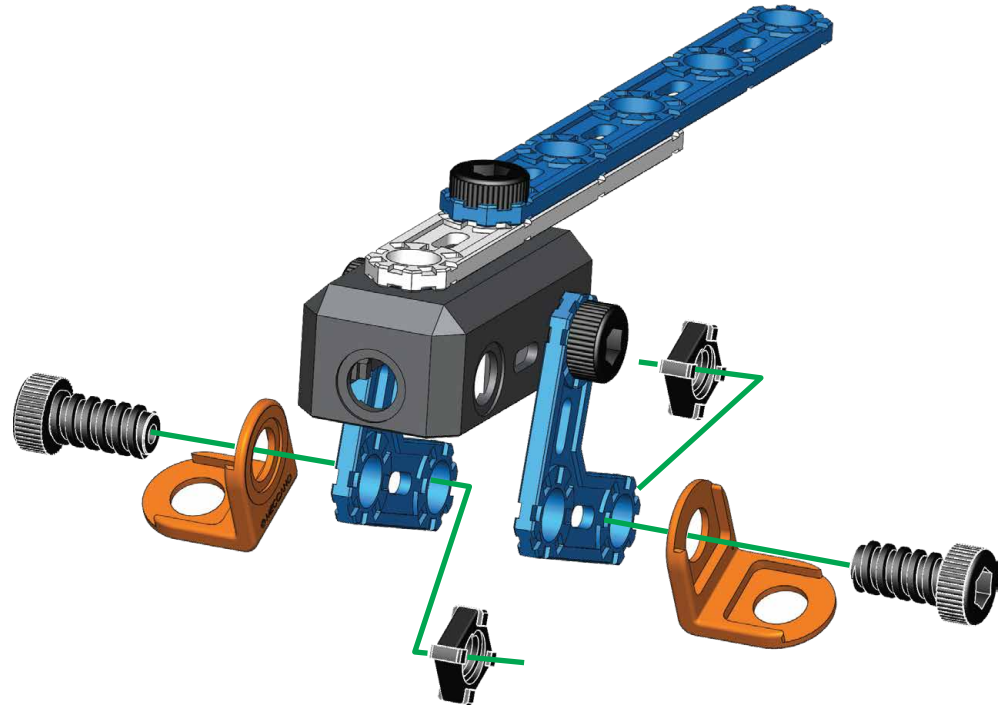
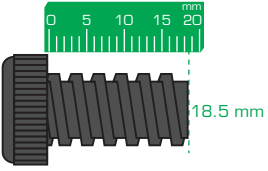

**4**

-  x 2
-  x 2
-  x 2



**5**

-  x 1
-  x 1
-  x 1

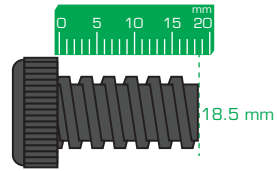

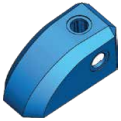

**6**

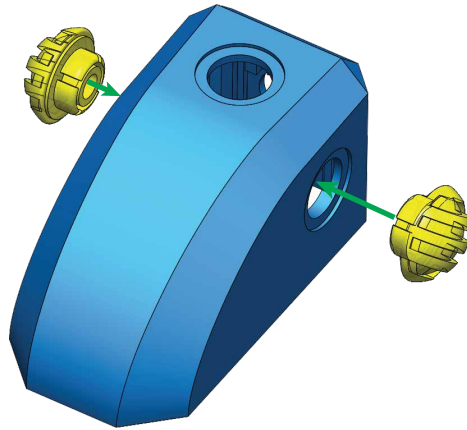
	x 2
	x 1



**7 5+6**

	x 1
	x 2
	x 1

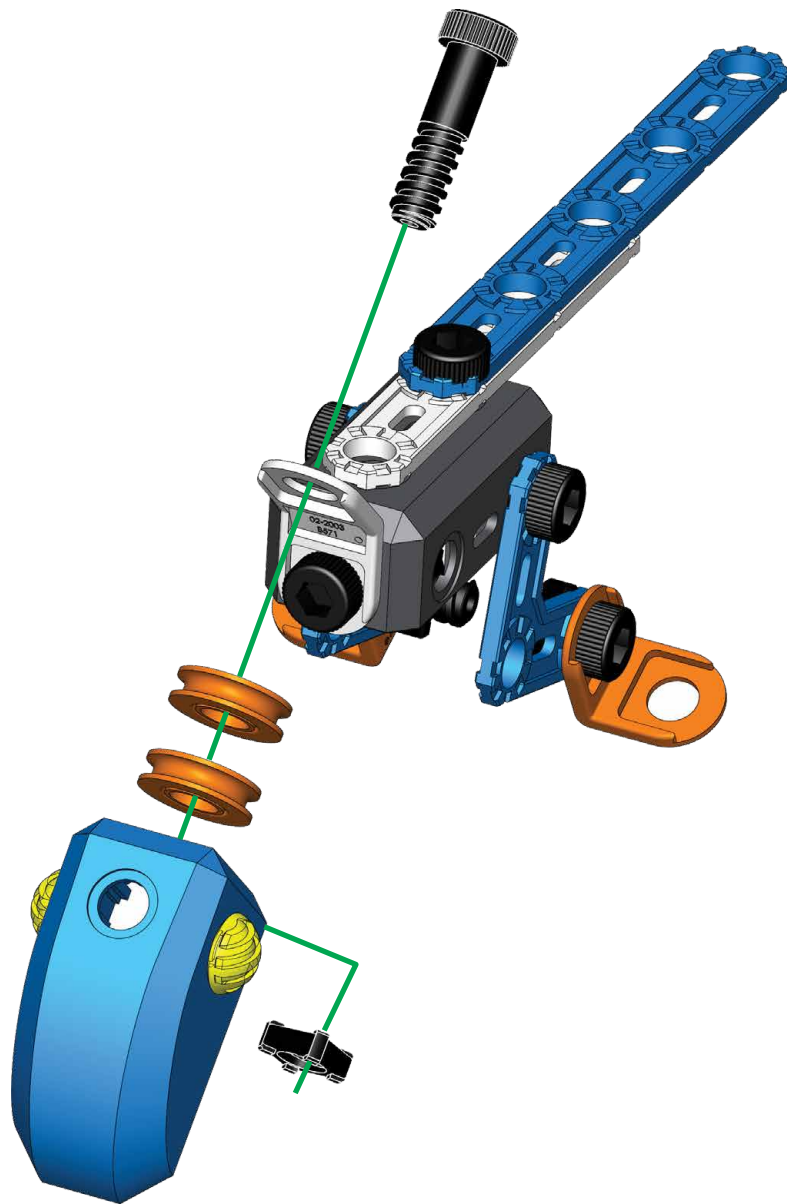
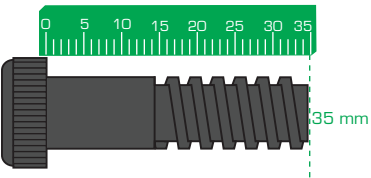

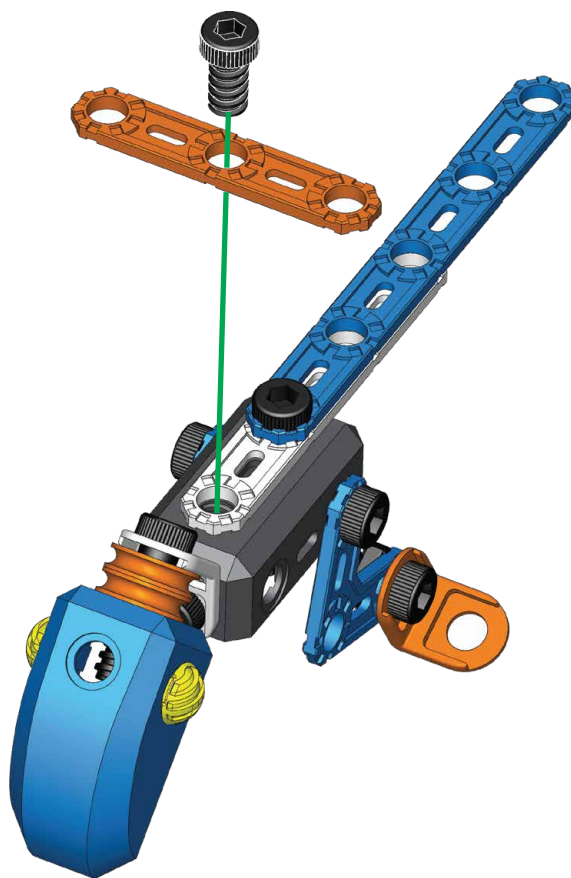
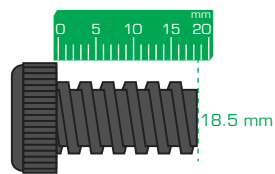
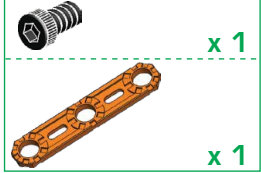

8

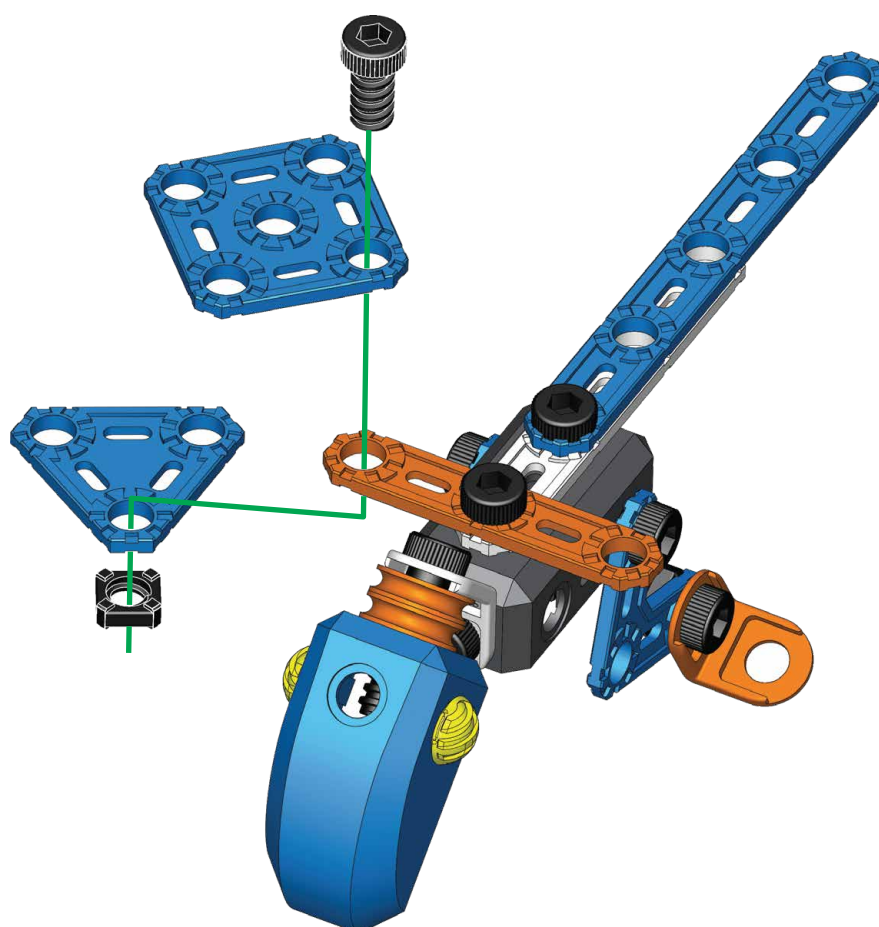
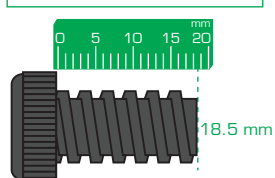
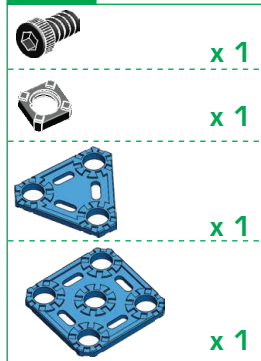

9



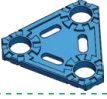
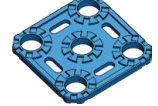

10

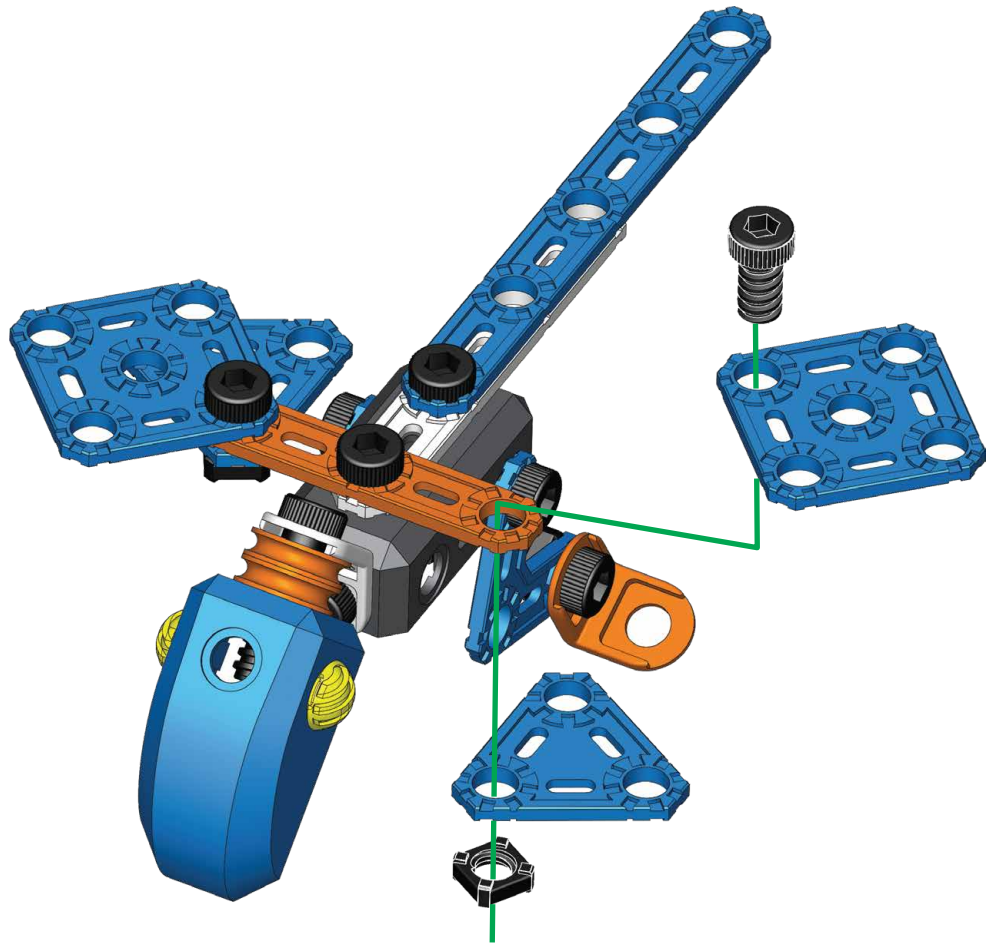
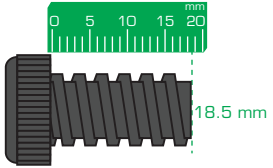
-  x 1
-  x 1
-  x 1
-  x 1



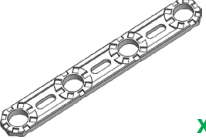

11

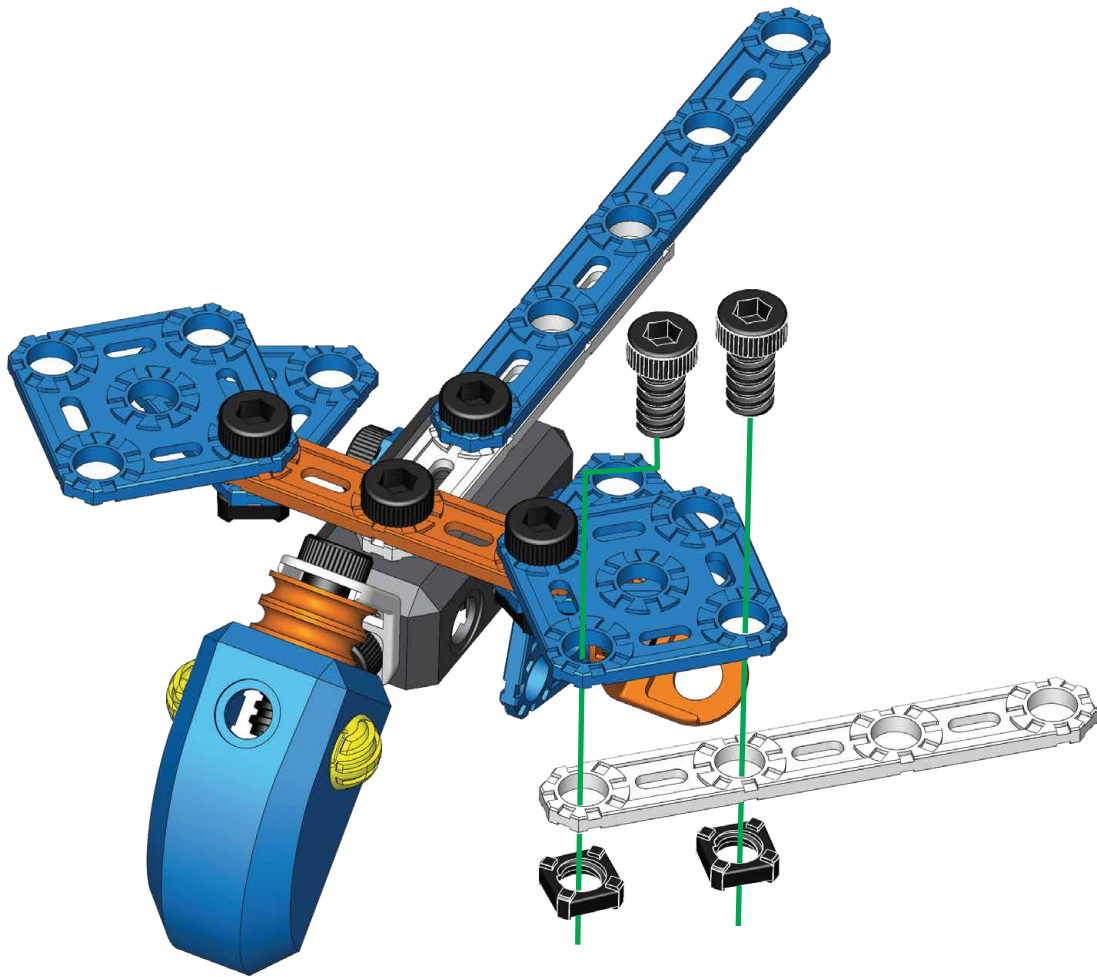
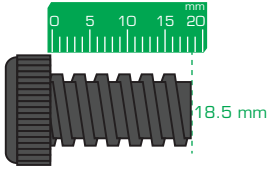
-  x 2
-  x 2
-  x 1



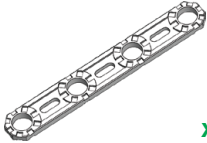

12

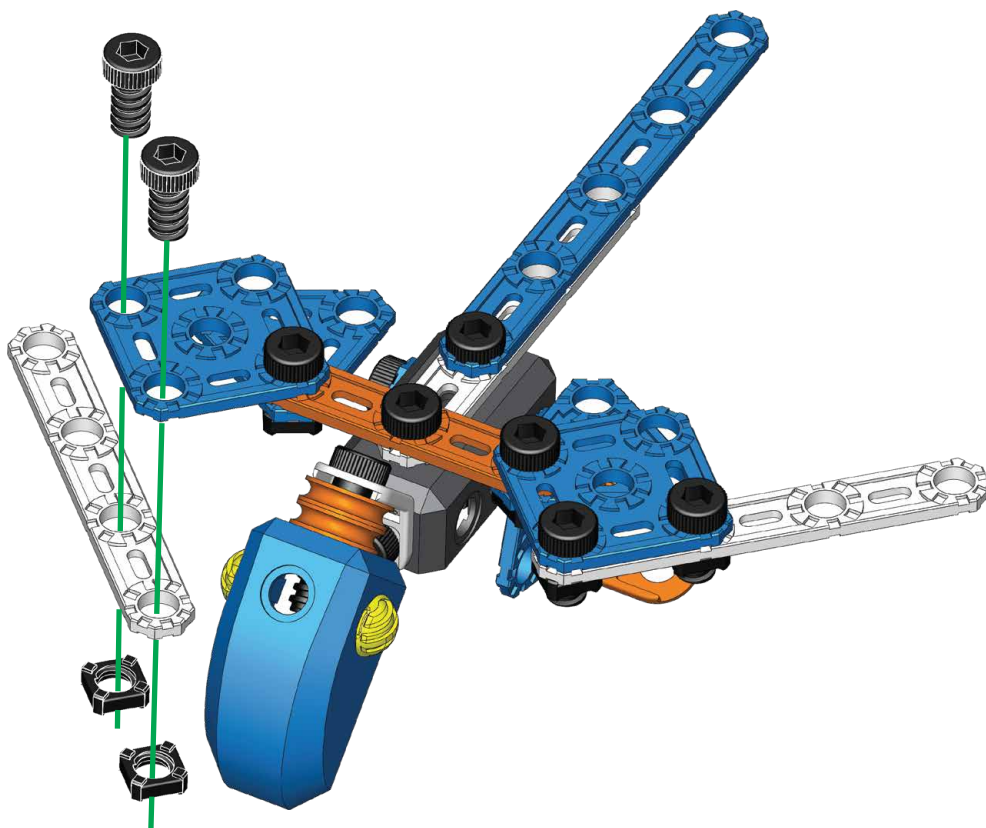
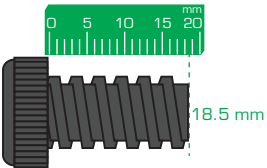
-  x 2
-  x 2
-  x 1



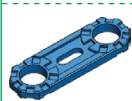

13

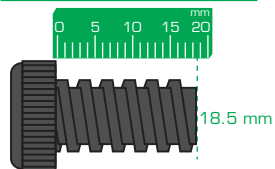
-  x 1
-  x 1
-  x 1



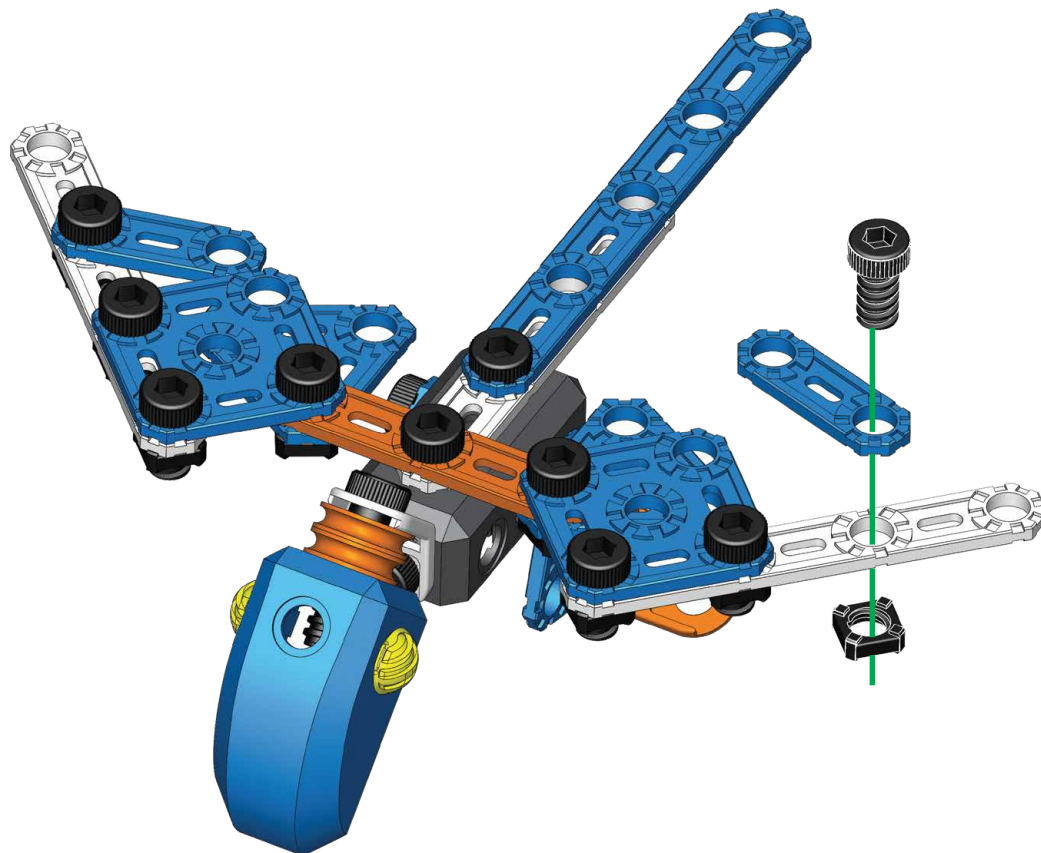
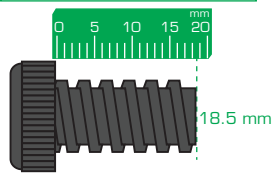

14

-  x 1
-  x 1
-  x 1

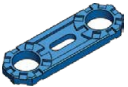

15

-  x 1
-  x 1
-  x 2

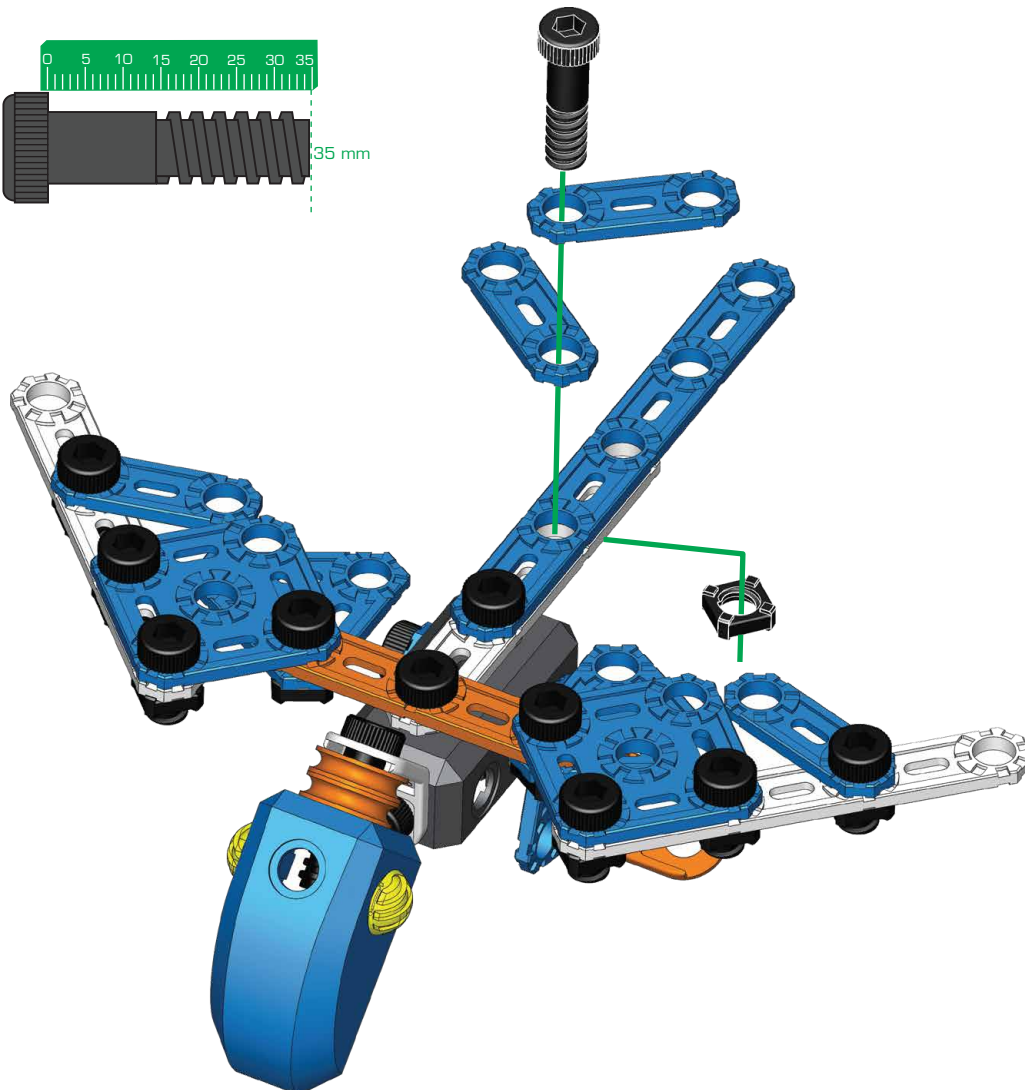
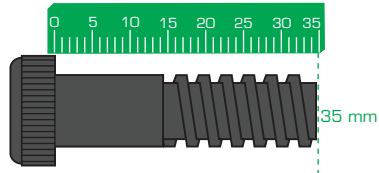



16

