

6891

MECCANO[®]
JUNIOR!



 6-8

- GB** With Meccano Junior your child will have great fun learning how to build both with instructions and their own imagination. They will develop important motor skills using the nuts and bolts construction system, improve sorting, counting and concentration skills.
- F** Avec Meccano Junior, votre enfant ne va pas seulement s'amuser, créer, exercer son imagination, il va aussi apprendre à construire, affiner sa grapho-motricité en vissant, s'exercer à compter, trier des pièces, apprendre à se concentrer, à suivre un plan, à s'organiser.
- D** Mit Meccano Junior wird Ihr Kind nicht nur Spaß haben, kreativ sein und seine Phantasie erweitern, sondern es wird auch lernen, Modelle zu bauen und durch das Schrauben seine Feinmotorik zu verbessern. Es übt sich im Zählen, lernt richtige Bauteile auszuwählen, sich zu konzentrieren und zu organisieren, sowie einer Bauanleitung zu folgen.
Meccano Junior begleitet und stimuliert somit die psychologische (Phantasie, Kreativität und Ausdauer) und motorische (Geschicklichkeit, Genauigkeit) Entwicklung Ihres Kindes.
- I** Con Meccano Junior i vostri bambini potranno non solo divertirsi, creare ed esercitare la propria immaginazione, ma anche imparare a costruire, sviluppare capacità motorie e logiche, esercitarsi a contare, a scegliere i pezzi.
Impareranno inoltre a concentrarsi, a seguire un piano, ad organizzarsi.
- E** Con Meccano Junior, vuestro hijo no va únicamente a divertirse, crear, ejercitar su imaginación, también aprenderá a construir, a contar, a escoger piezas, a concentrarse, seguir instrucciones, a organizarse y además afinará su psicomotricidad.
- P** Com Meccano Junior, o vosso filho não só se vai divertir, criar, exercitar a imaginação, mas também aprenderá a construir, a contar, a escolher peças, a concentrar-se, a seguir instruções, a organizar-se e, além disso, afinará a sua psicomotricidade.
- S** Med Meccano Junior kommer ditt barn att få mycket roligt, genom att både lära sig att bygga efter en instruktion och med hjälp av den egna fantasin.
Barnet utvecklar motoriken genom att använda muttrar och skruvar, vidareutvecklar färdigheter såsom sortering, räkning och koncentrationsförmågan.
- FIN** Meccano Junior sarjan avulla lapsella on hauskaa oppiessaan rakentamaan sekä ohjeiden mukaan että omaa mielikuvitustaan käyttäen.
Tärkeät motoriset taidot kehittyvät, kun tutustutaan rakennussarjan ruuveihin ja muttereihin, ja lajittelu-, laskenta- ja keskittymistaidot paranevat.
- DK** Med Meccano Junior vil dit barn have meget sjov ud af at lære at bygge, både med hjælp fra instruktionerne og af egen fantasi.
Børn udvikler vigtige motoriske evner ved at bruge konstruktionssystemet med møtrikker og bolte. De bliver bedre til at sortere de forskellige dele, samt til at tælle, koncentrere sig, følge en plan og organisere sig.
- NL** Met Meccano Junior leert uw kind met veel plezier te bouwen met behulp van de instructies en zijn/haar eigen fantasie.
Door het bouten-en-moeren-constructiesysteem te gebruiken, ontwikkelen en verbeteren ze belangrijke vaardigheden zoals sorteren, tellen en concentreren.
- GR** Με το Meccano Junior, το παιδί σας όχι μόνον θα διασκεδάσει, δημιουργήσει, εξασκήσει τη φαντασία του, θα μάθει επίσης να κατασκευάζει, εκλεπτύνει τις δυνατότητές του γραφής βιδώνοντας, θα εξασκηθεί στο μέτρημα, διαλογή τεμαχίων, θα μάθει να συγκεντρώνεται, να ακολουθεί ένα σχέδιο, να οργανώνεται.
- JPN** 皆さまのお子様はMeccano Juniorで、説明書に従った、または想像力を働かせた組立てを楽しみ、それと同時にボルトとナットを使ったセットの組立てで、器用さ、数の計算、分類、そして集中能力を養います。



 6-8

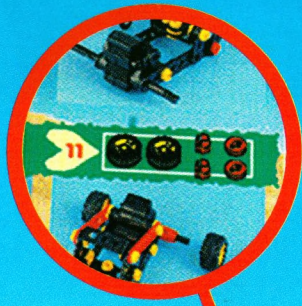

Follow the instructions and select parts.
Suis la notice et choisis tes pièces.
Folge der Bauanleitung und wähle die richtigen Teile aus.
Segui le istruzioni e scegli i pezzi.

Sigue las instrucciones y escoge tus piezas.
Segue as instruções e escolhe as tuas peças.
Følj instruksjonen och välj rätt delar.
Seuraa ohjeita ja valitse oikeat osat.

Følg instruktionerne og vælg de dele du skal bruge.
Volg de instructies en zoek de juiste onderdelen uit.
Ακολουθήσε τις οδηγίες και διάλεξε τα κομμάτια
組立て説明書の通りに部品を選ぼう



Use tools to build.
Construis avec tes outils.
Bau mit Hilfe Deiner Werkzeuge.
Utilizza gli attrezzi per costruire.

Utiliza las herramientas para montar.
Utiliza as ferramentas para construir.
Använd verktygen när du bygger.
Käytä työkaluja rakentamiseen.

Brug dit værktøj til at bygge med.
Gebruik je gereedschap bij het bouwen.
Κατασκεύασε με τα εργαλεία
道具で組立てよう

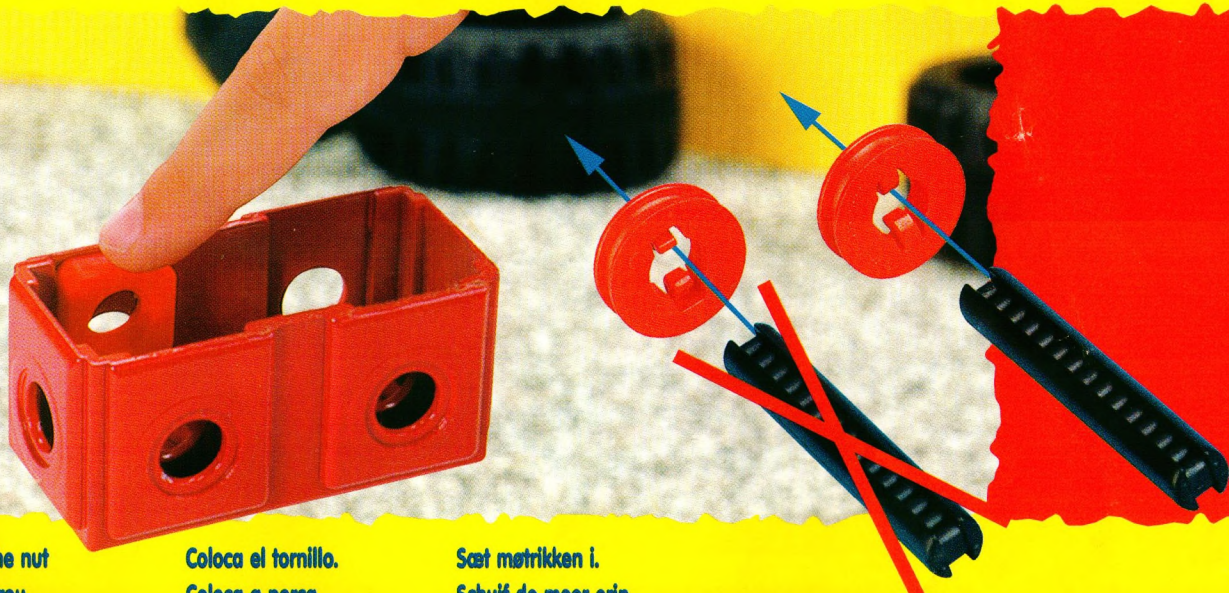

Slide in the nut
Place l'écrou
Plaziere die Mutter
Posiziona il dado.

Coloca el tornillo.
Coloca a porca.
Sätt i muttern.
Pujota mutteri sisään.

Sæt møtrikken i.
Schuif de moer erin.
Τοποθέτησε το παξιμάδι
ナットを付けよう

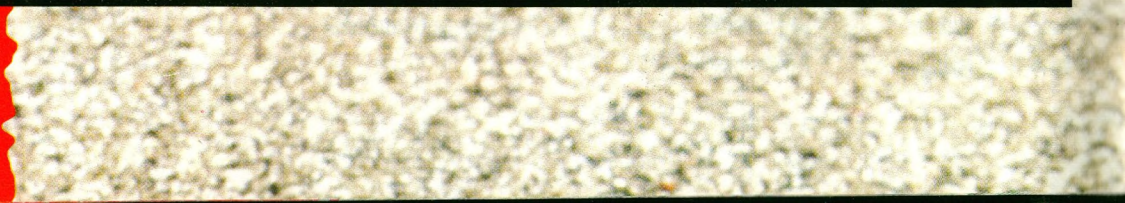
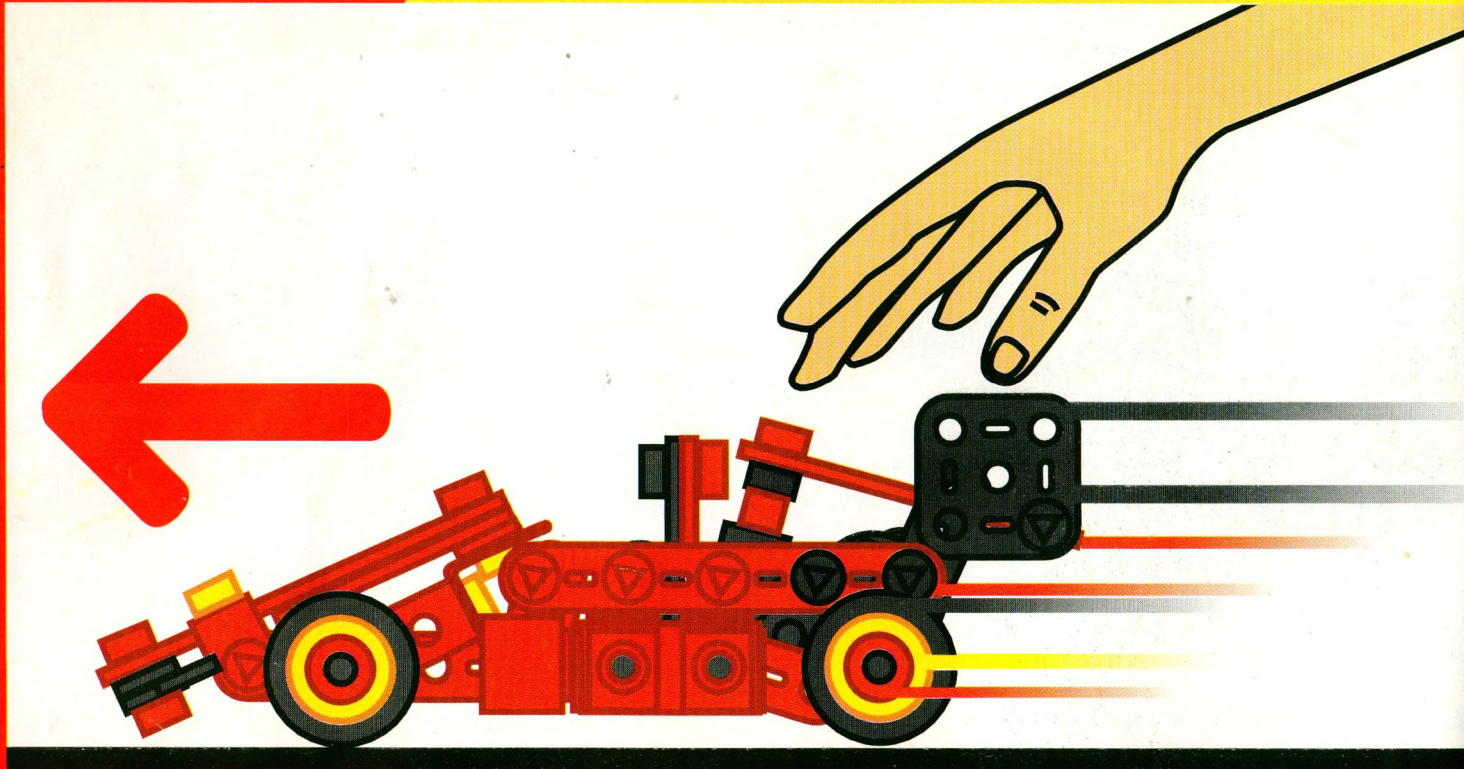
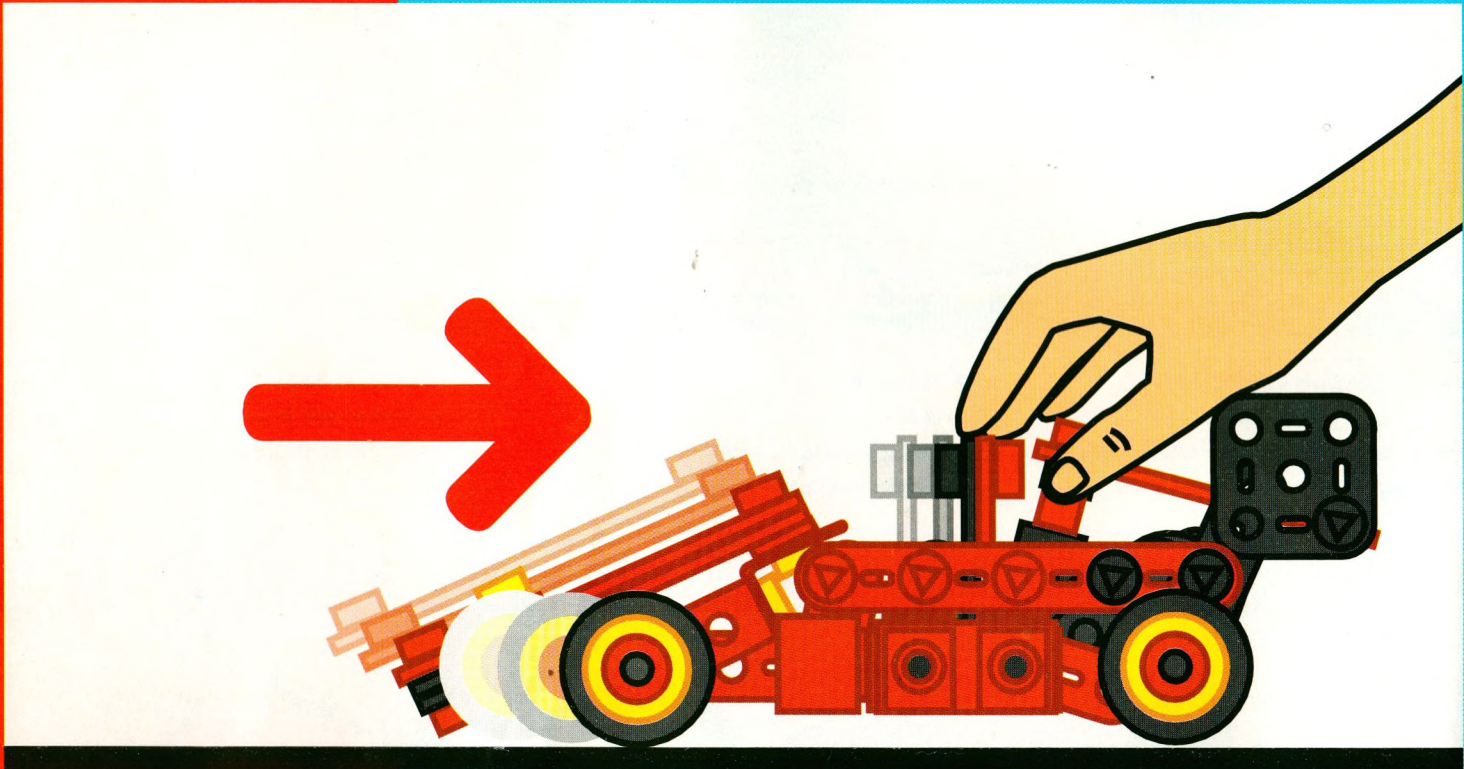

INDEX
INDEX
ÜBERSICHT
INDICE

ÍNDICE
ÍNDICE
INNEHÅLLSFÖRTECKNING.
SISÄLLYS.

INDHOLDSFORTEGNELSE.
INDEX
EYPETHPIO
索引



P 8



P 10



P 12



P 14



P 7



P 8



P 12



P 14



P 16



P 18

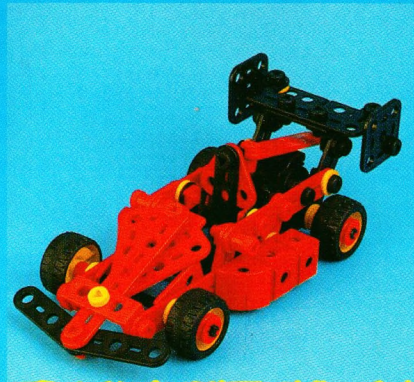

P 20



P 24



P 26



P 28



P 30

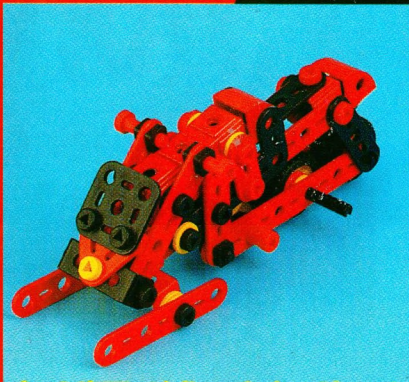

P 34



P 36

17

MODELS
MODELES
MODELLE

MODELLI
MODELOS
MODELOS

MODELLER
MALLIA
MODELLER

MODELLEN
MONTEAA
モデル

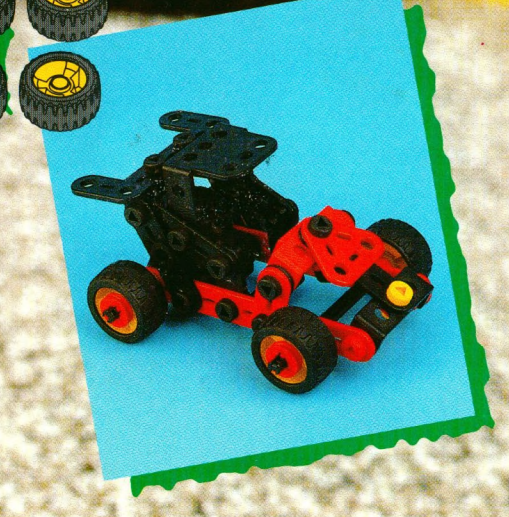
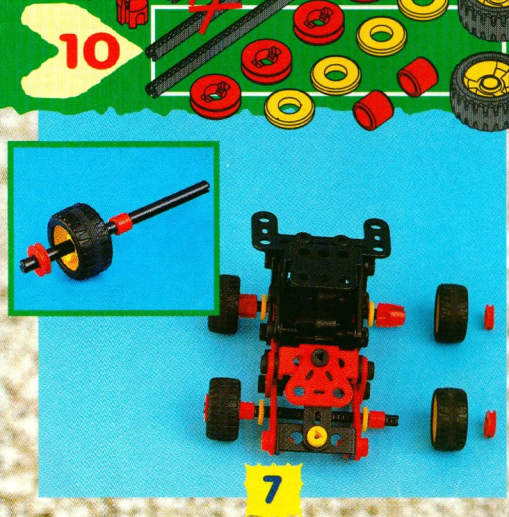
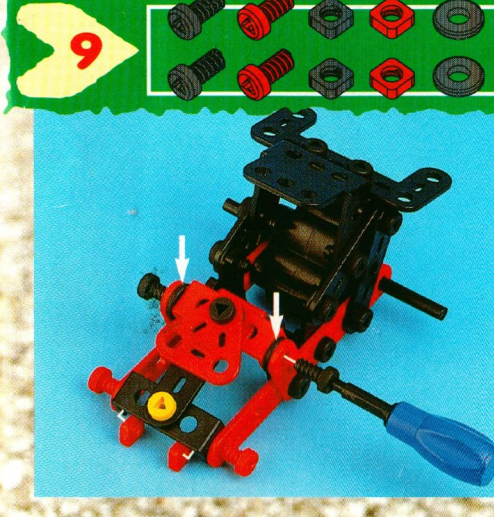
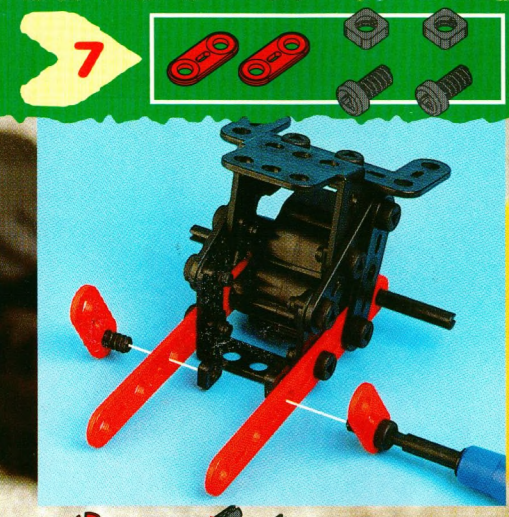
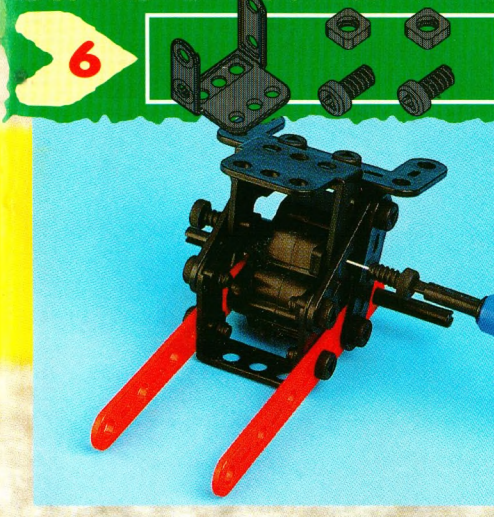
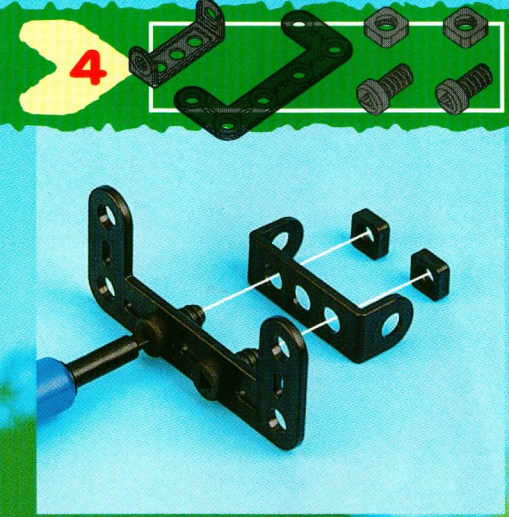
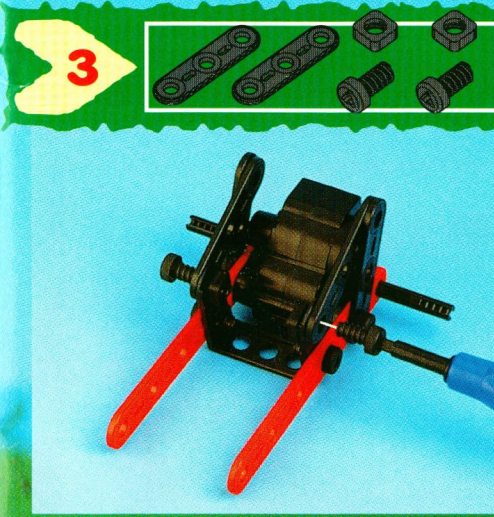
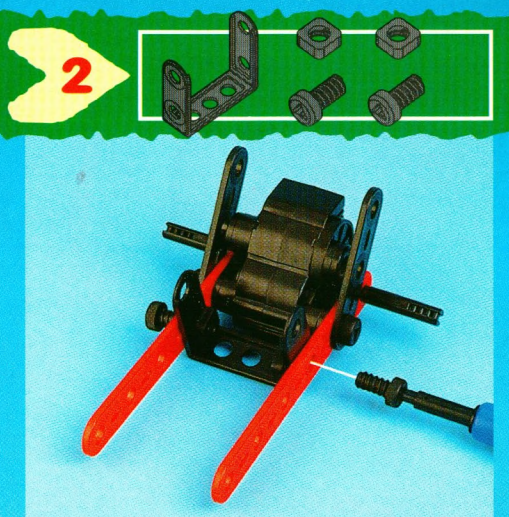
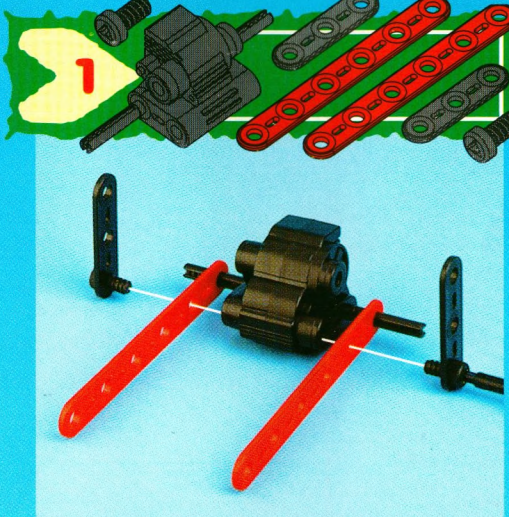

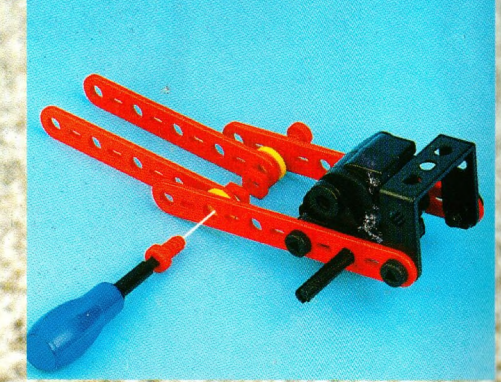
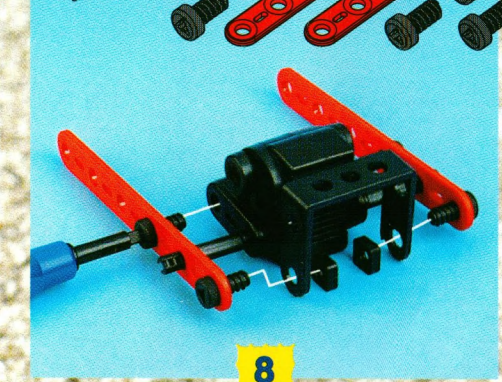
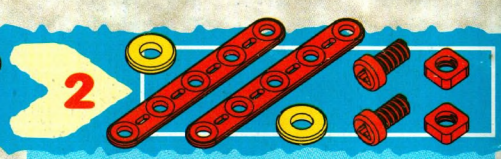
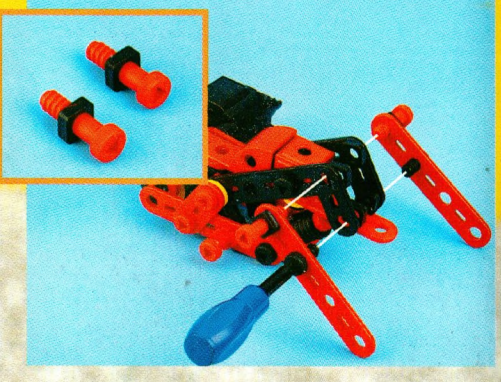
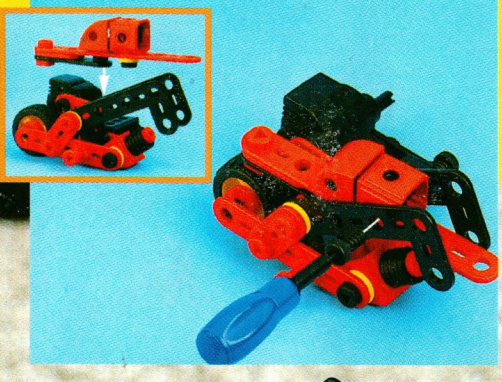
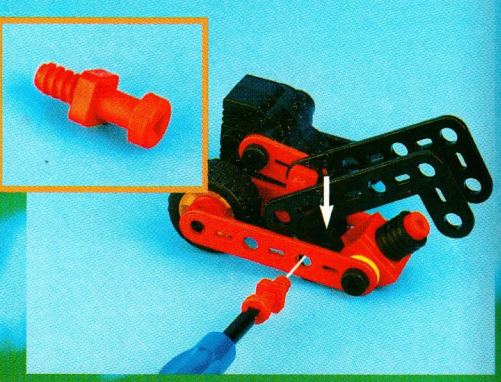
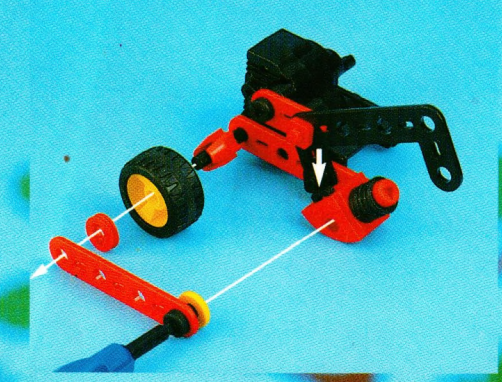
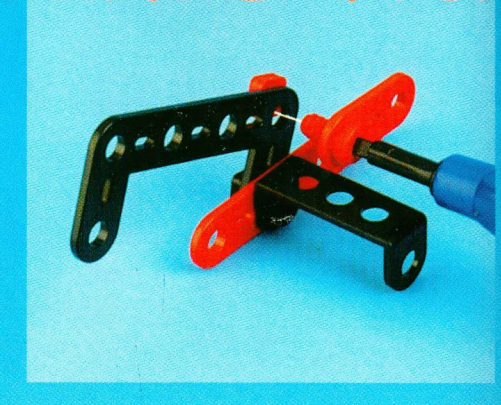
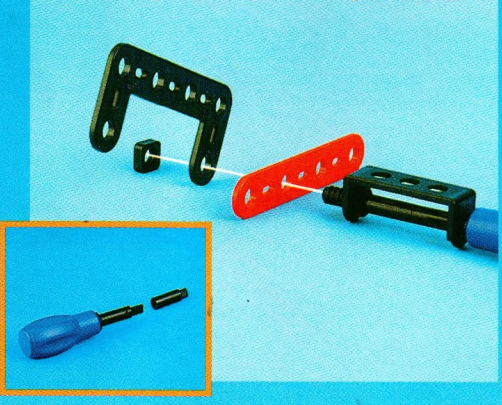
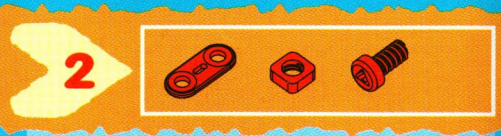
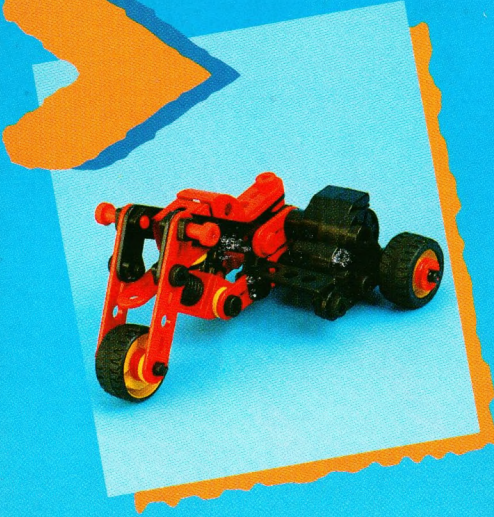

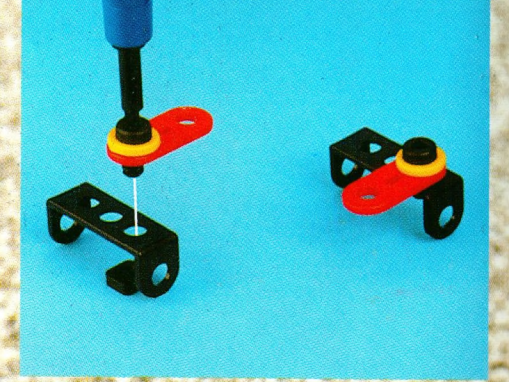
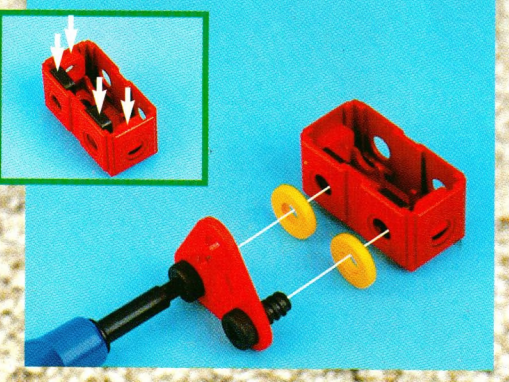
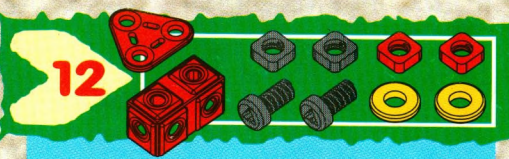
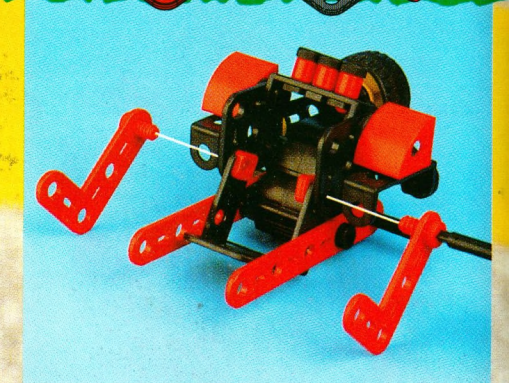
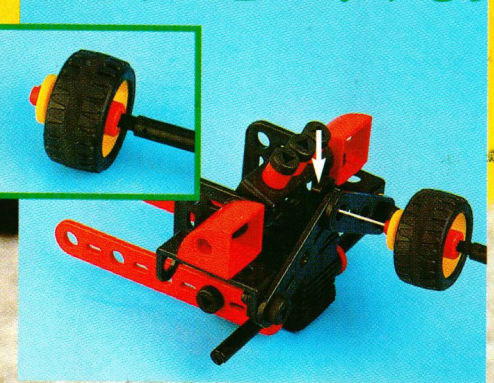
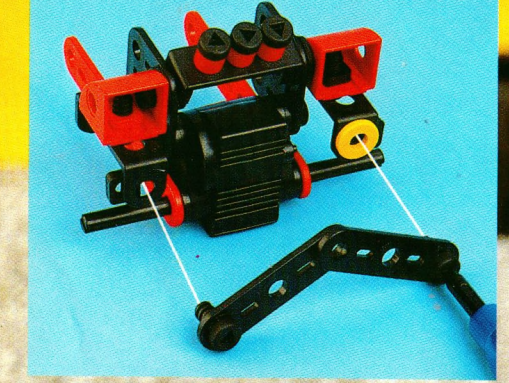
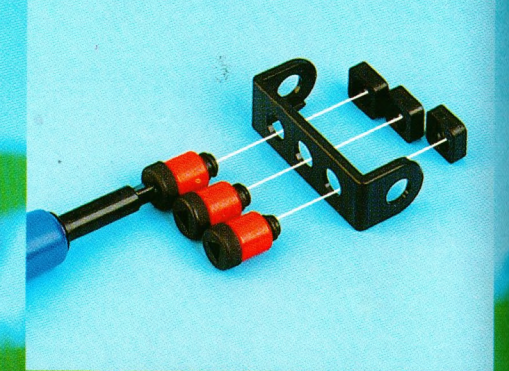
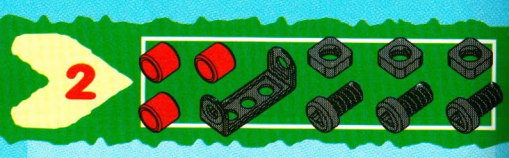
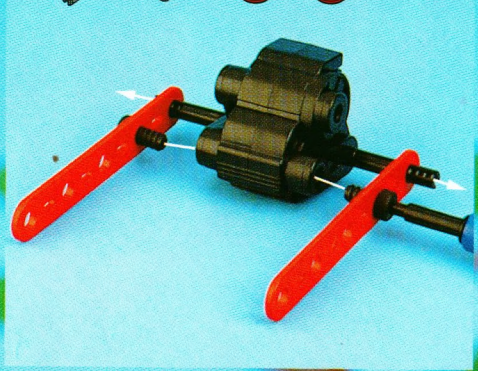
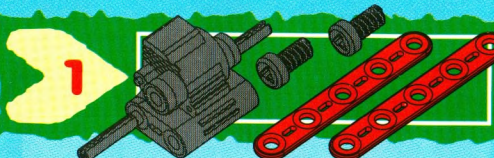
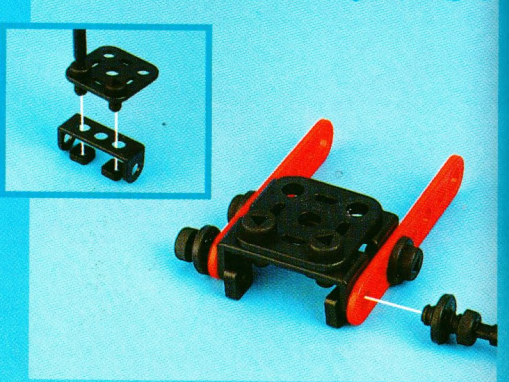
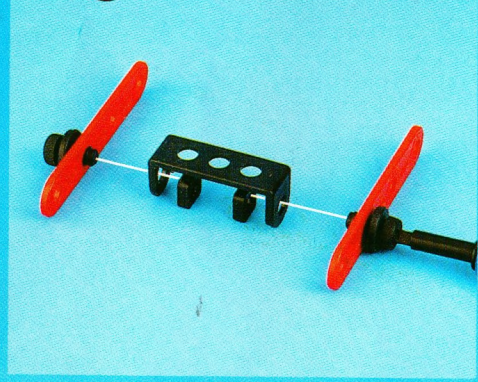
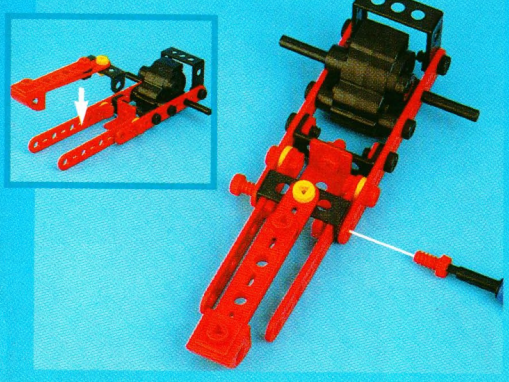

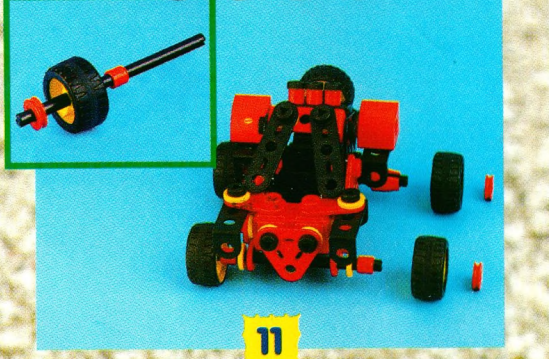
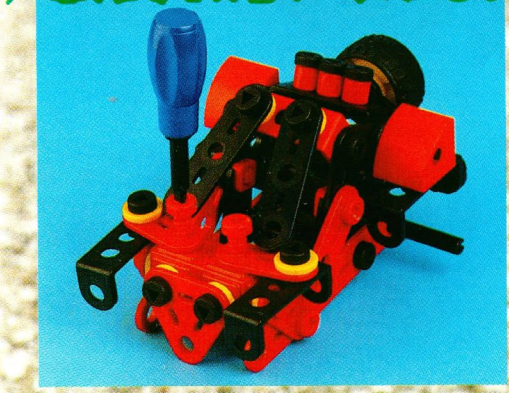
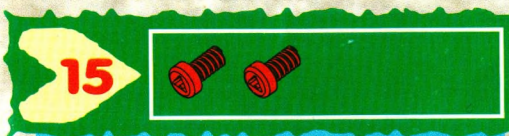
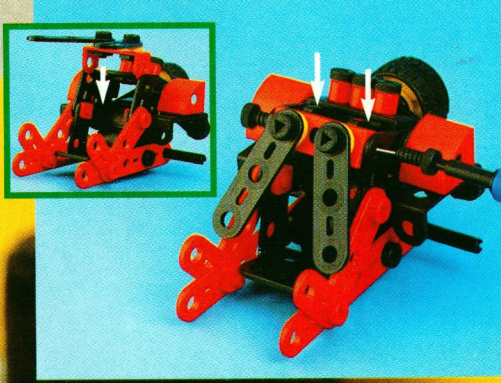
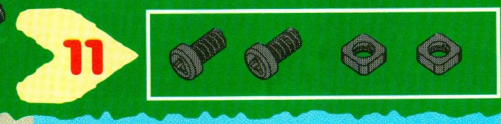
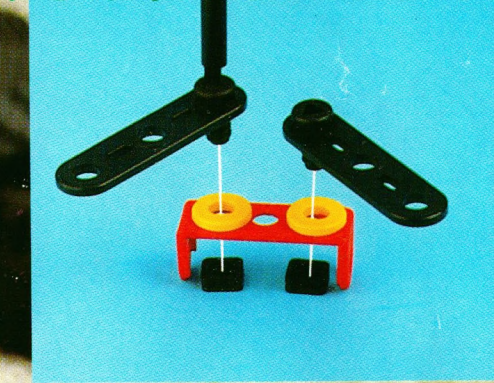
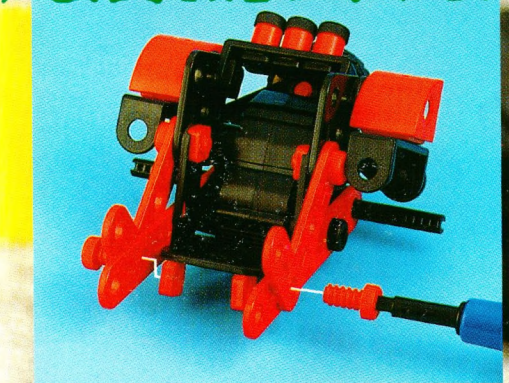
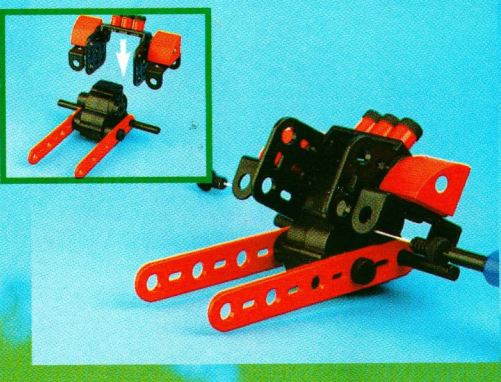
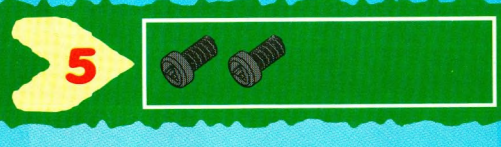
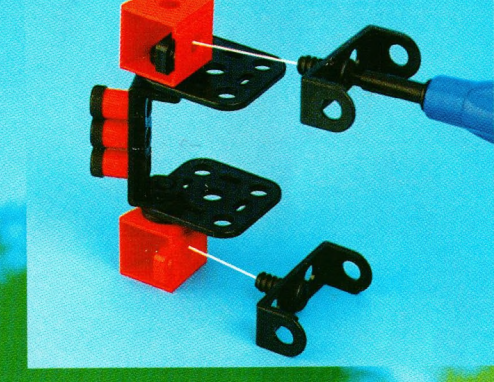
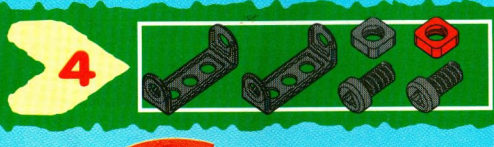
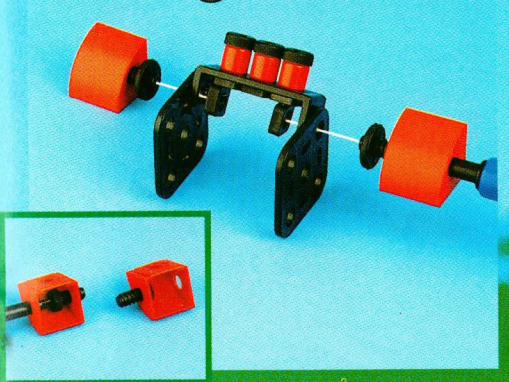
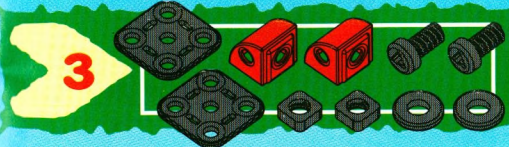
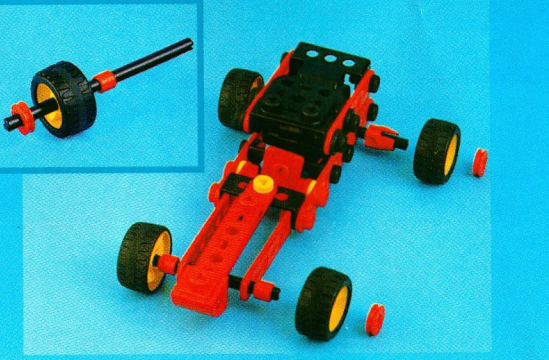
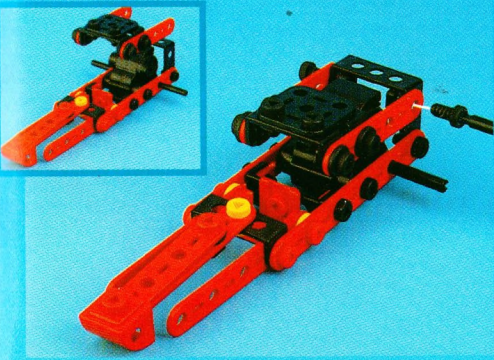

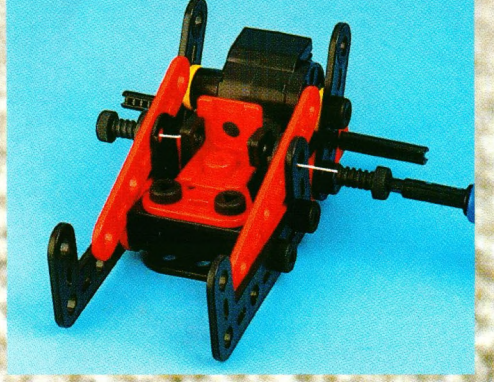
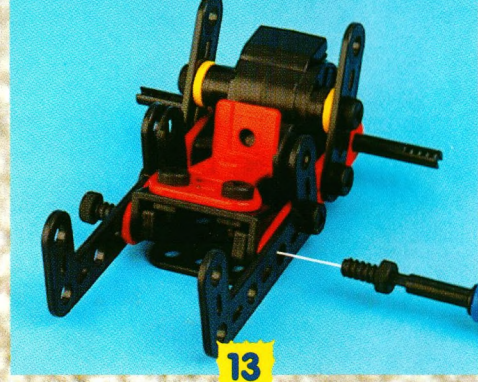
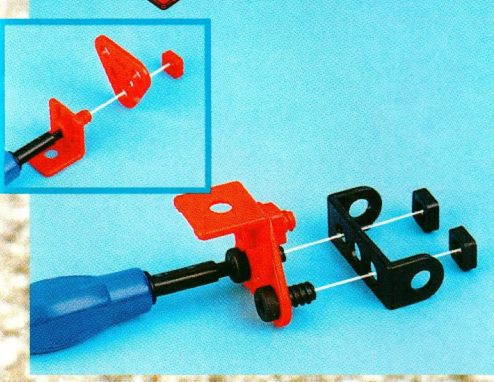
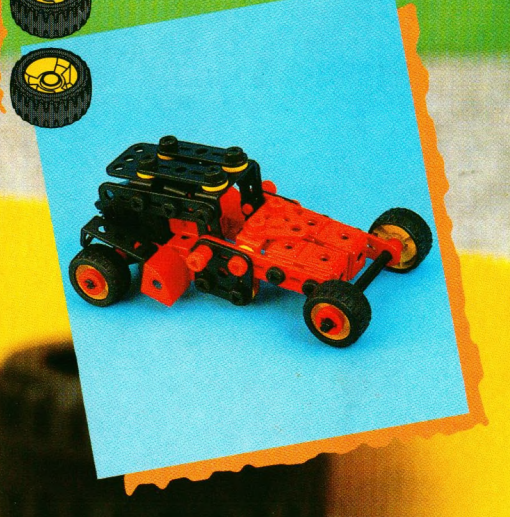
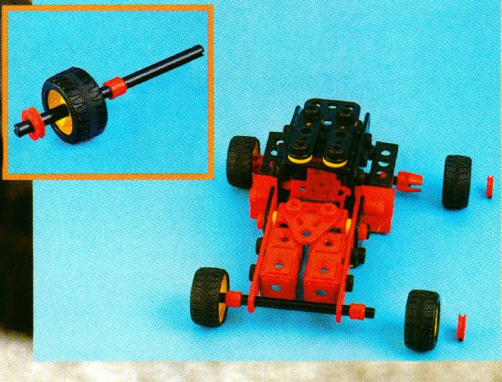
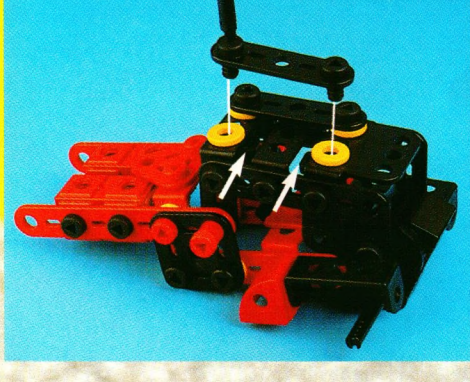
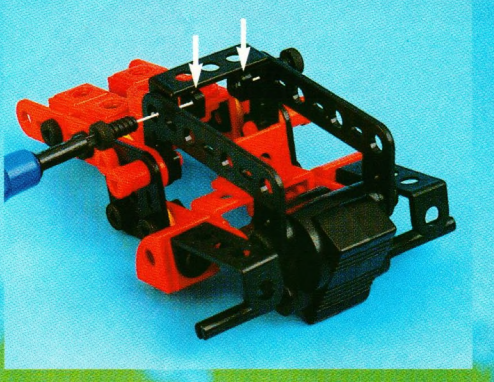
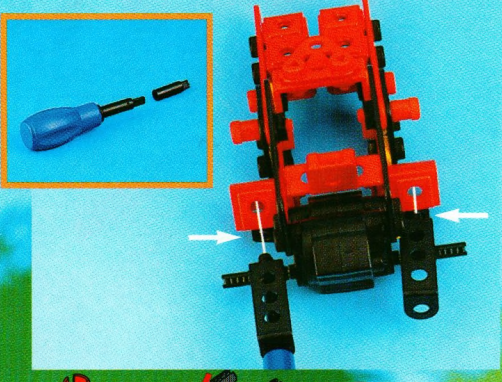
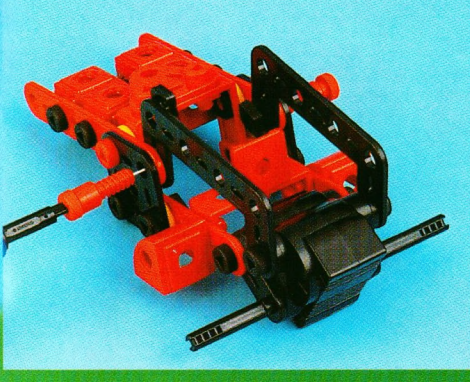
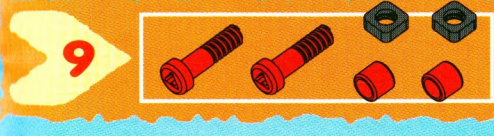
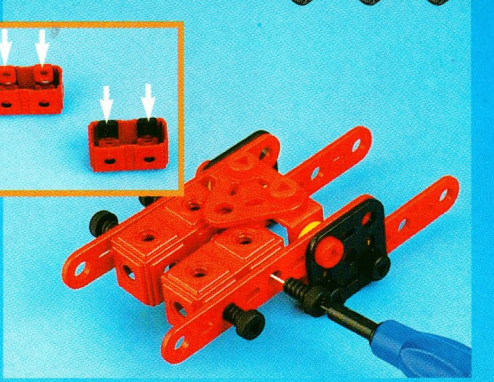
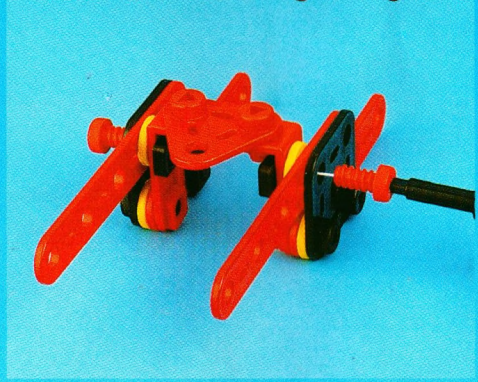
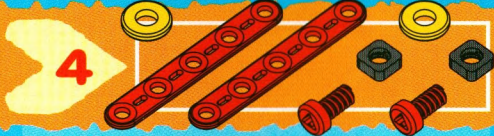
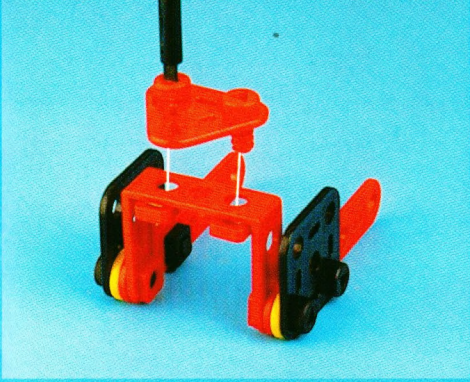

6



7



8

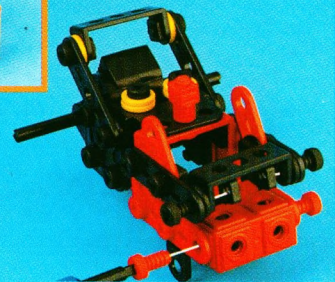
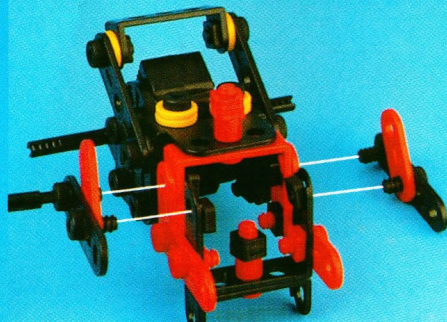
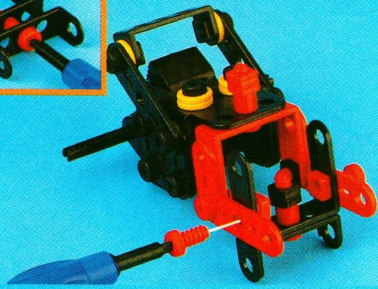
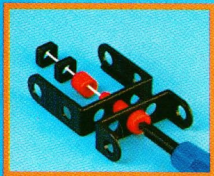

1

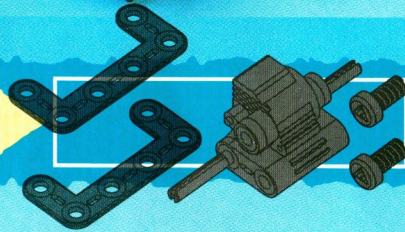

2

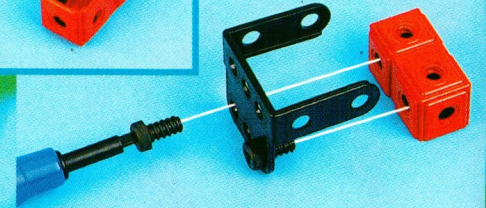
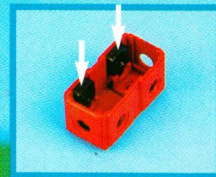
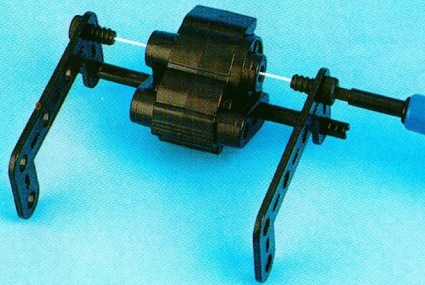

6



7

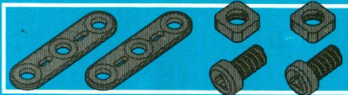

8

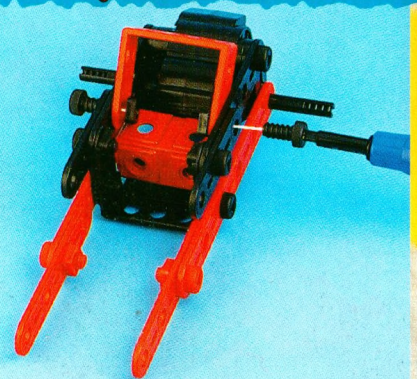
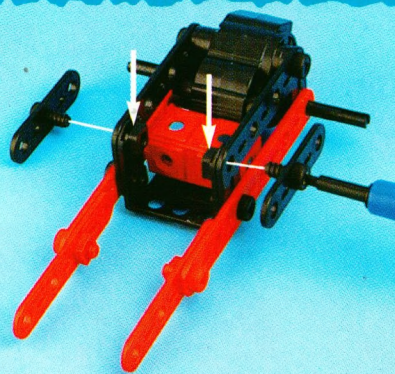
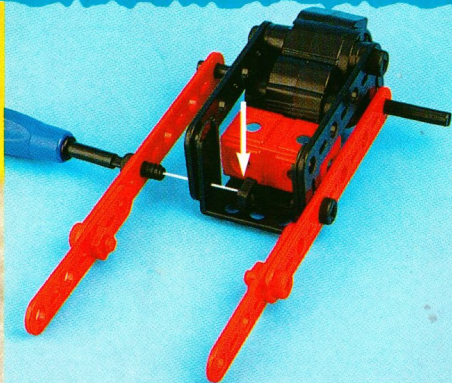

12



13



14

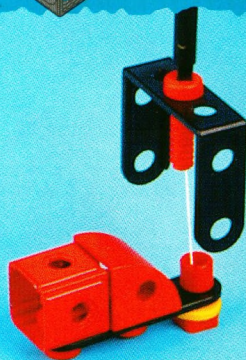
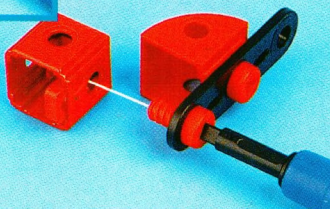
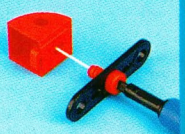

16

9



10

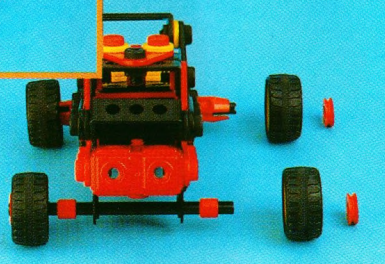
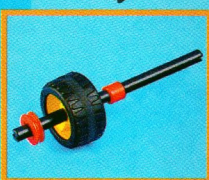
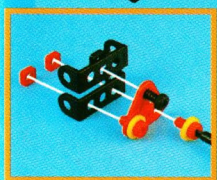
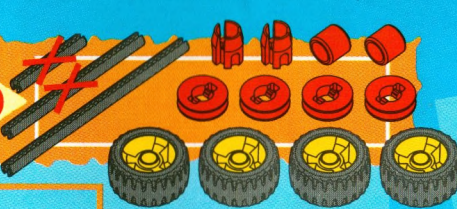

3

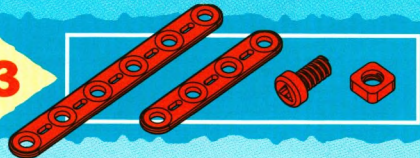

4



5

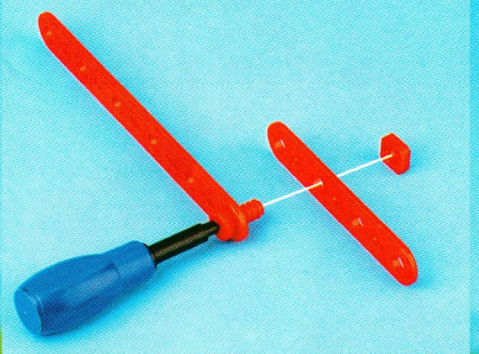
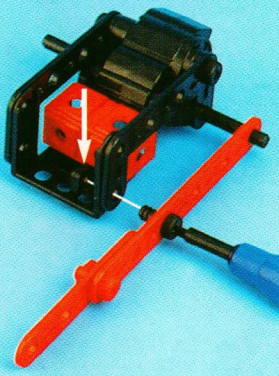
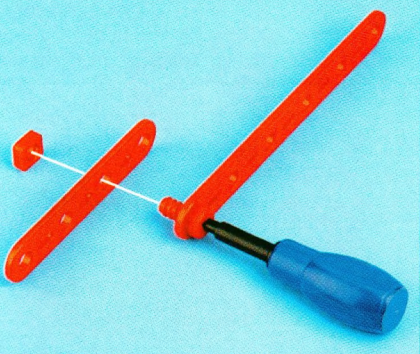
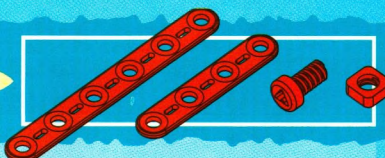

9



10



11

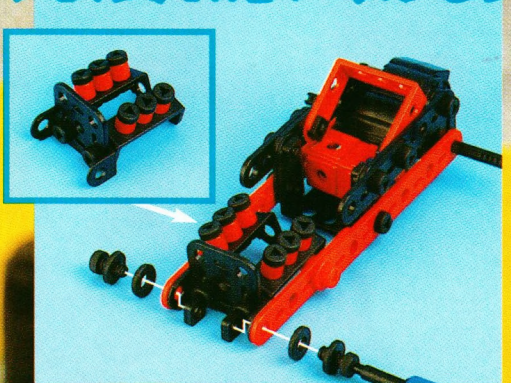
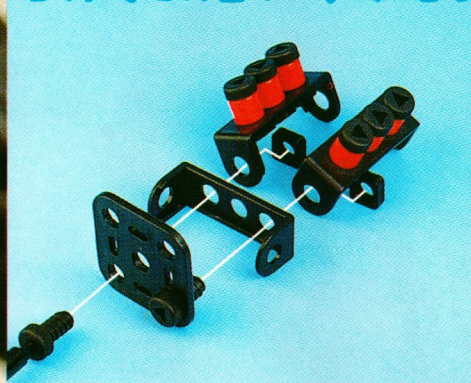
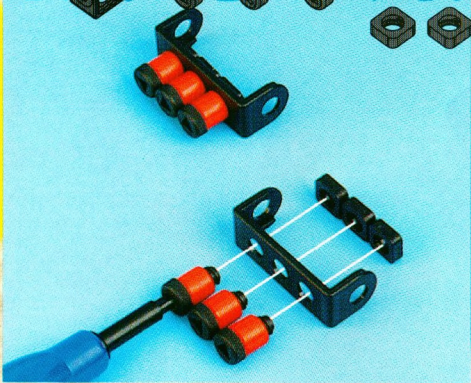

15



16

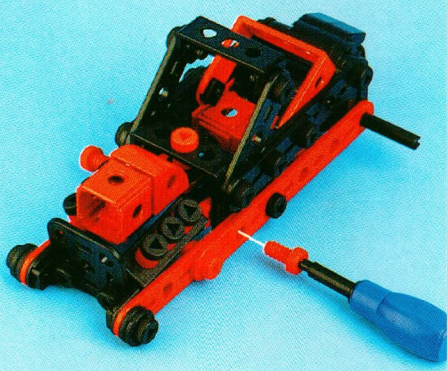
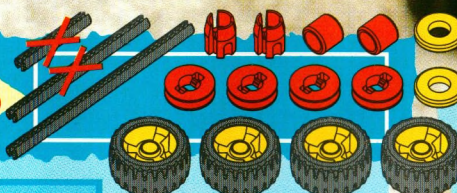

17

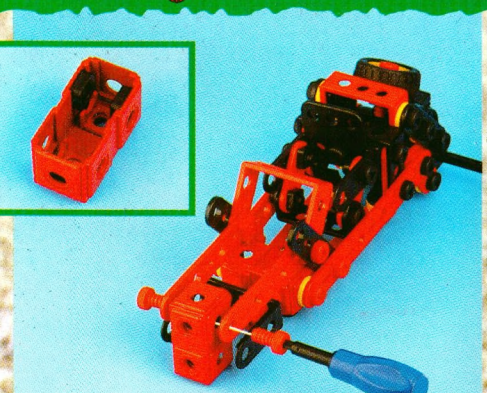
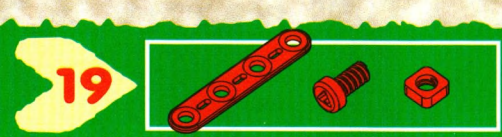
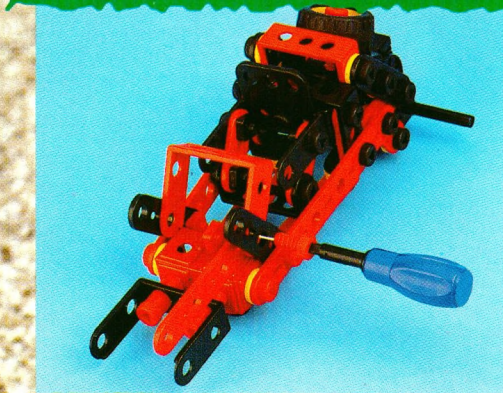
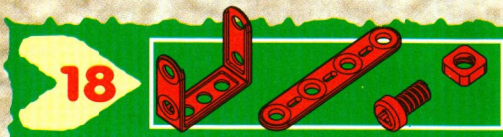
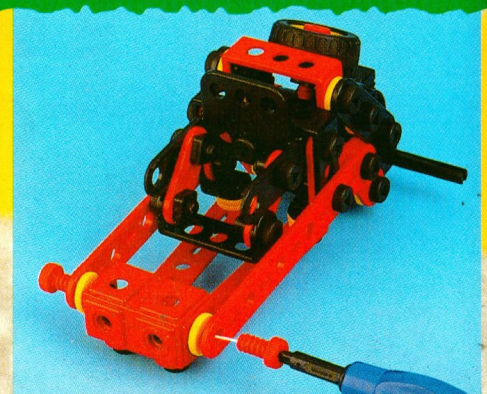
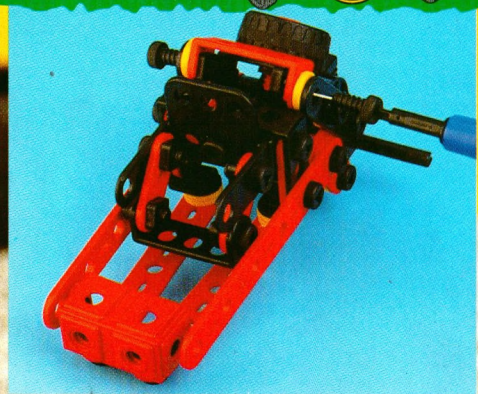
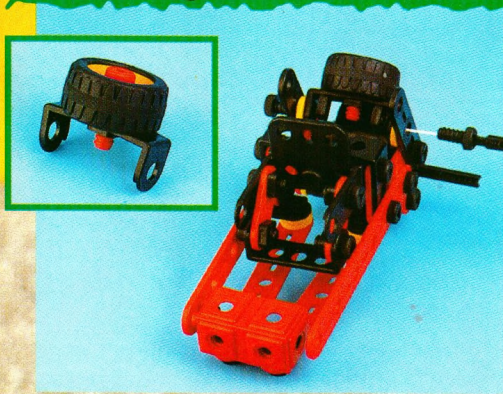
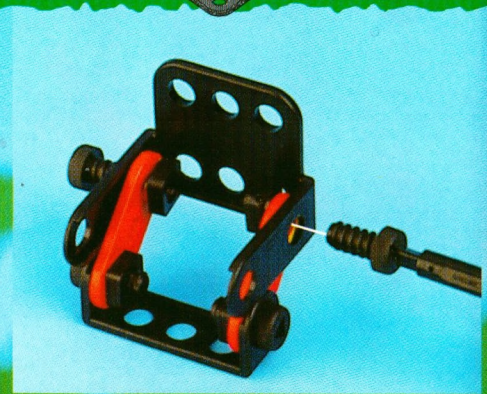
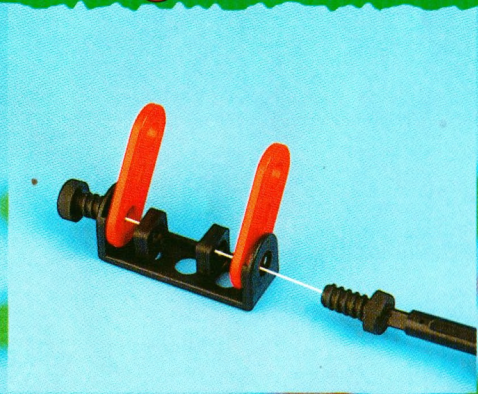
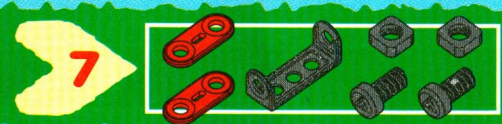
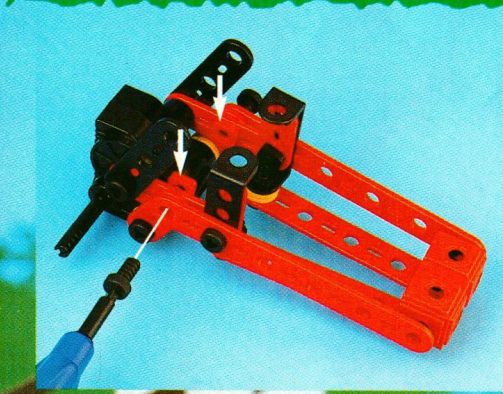
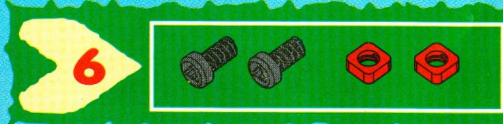
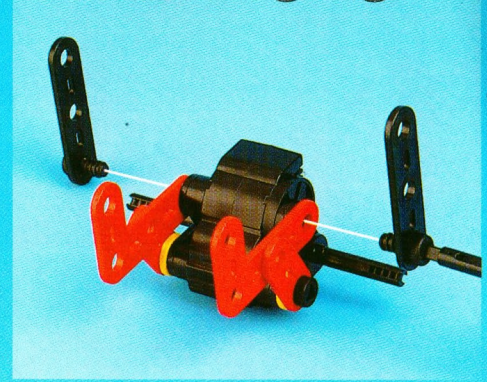
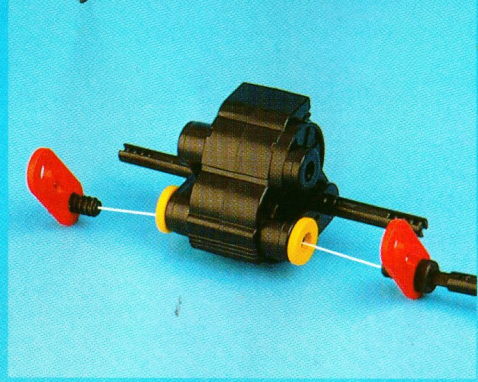
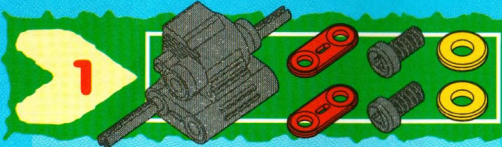

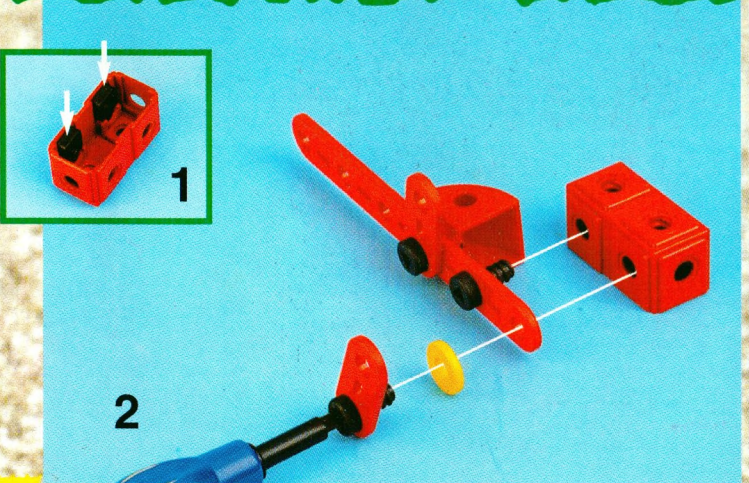
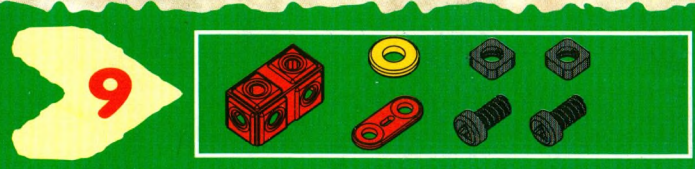
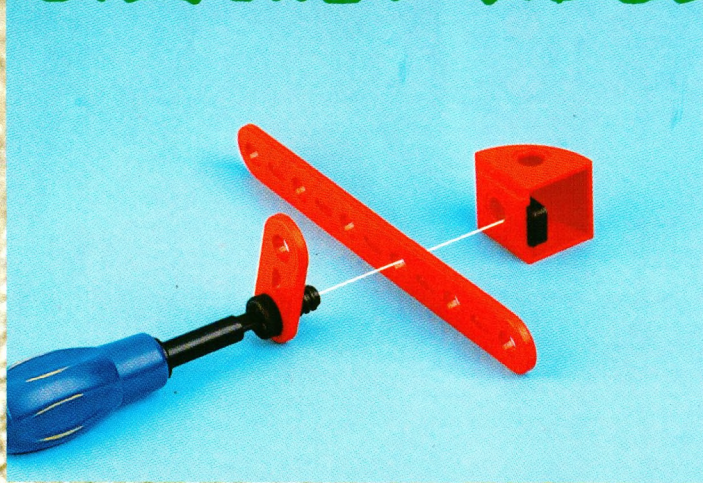
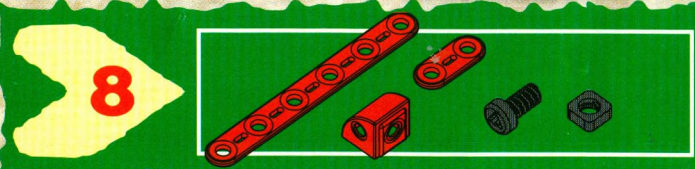
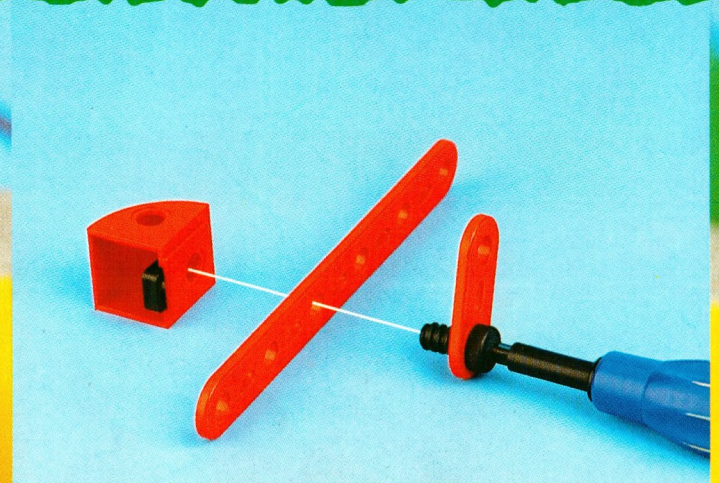
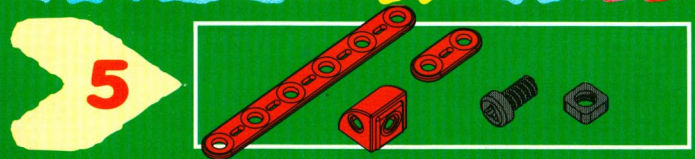
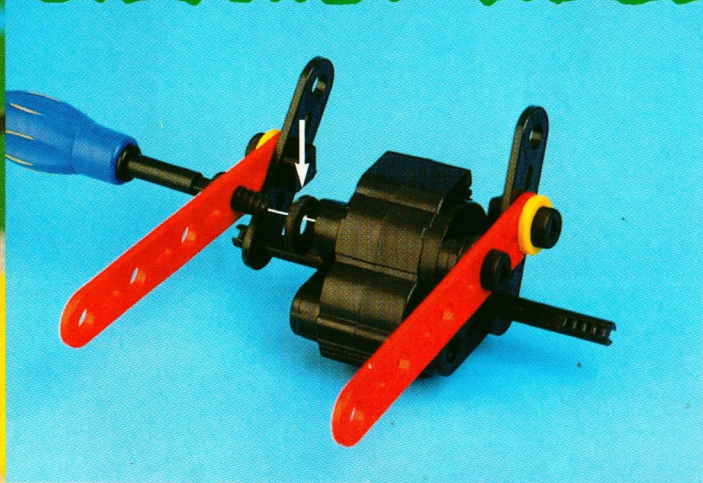
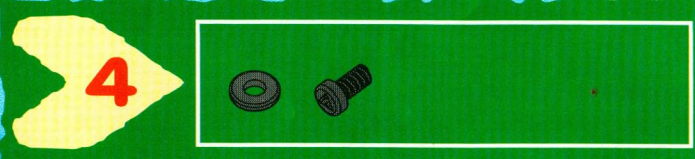
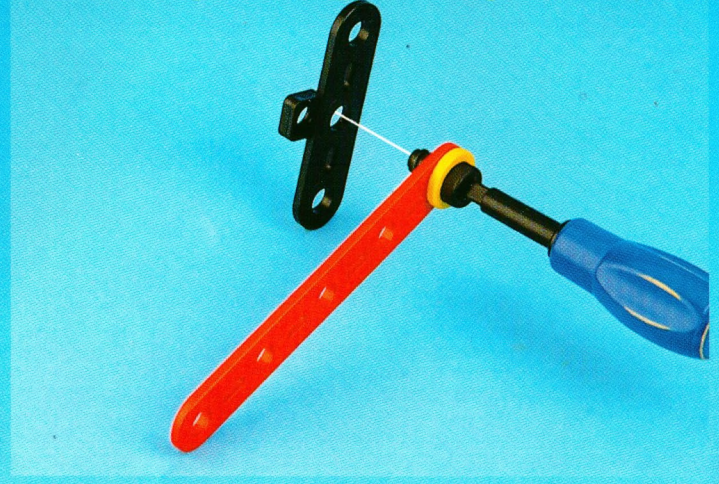

2

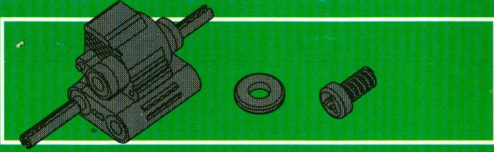

3

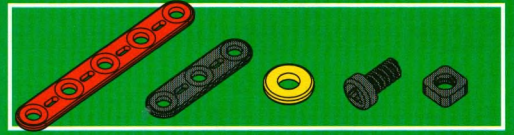

6

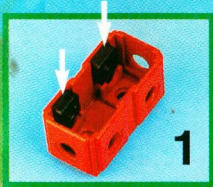
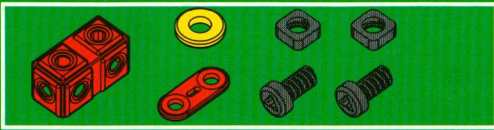

1

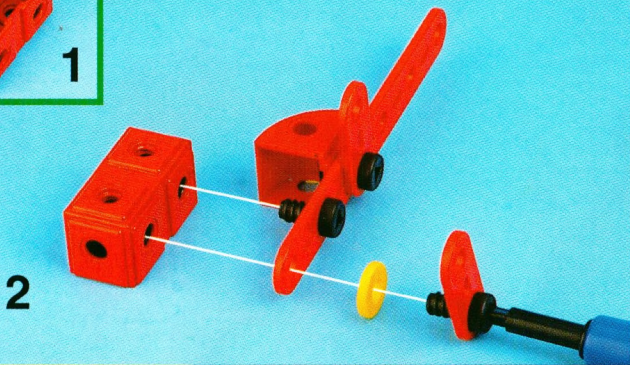

2

7

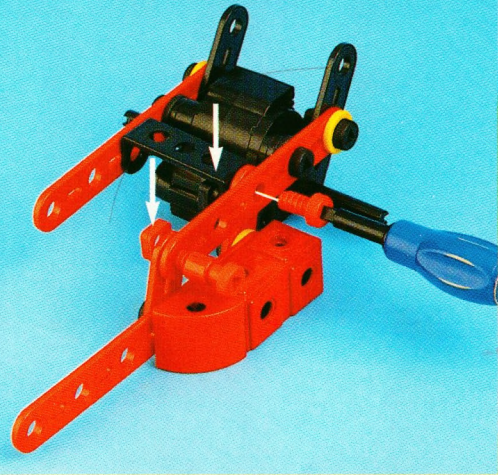

10

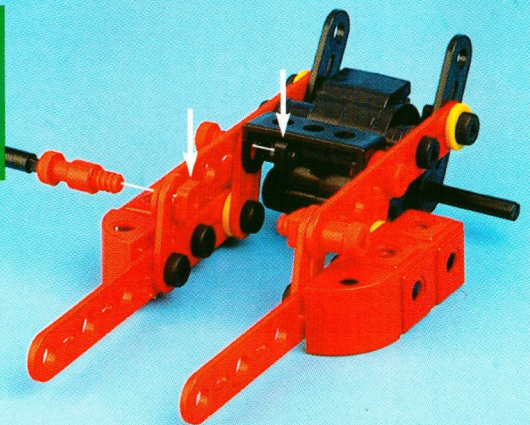
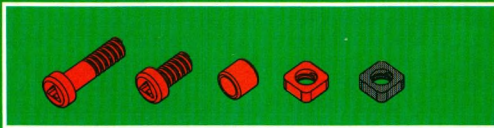

11

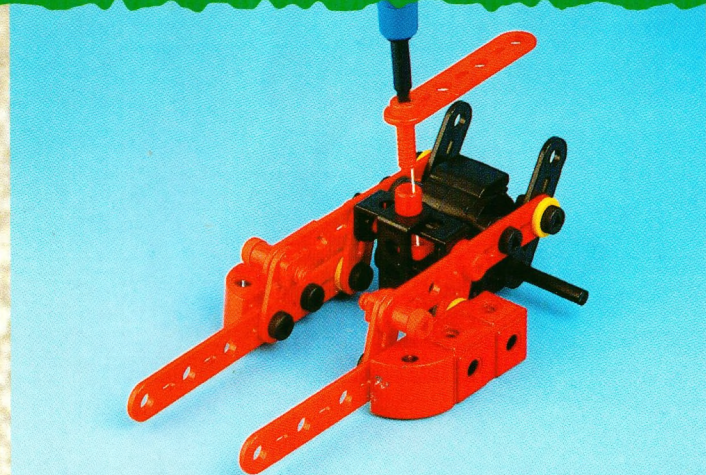

12

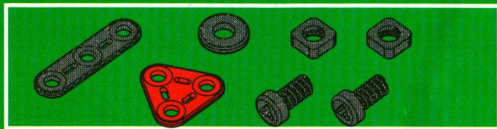

2

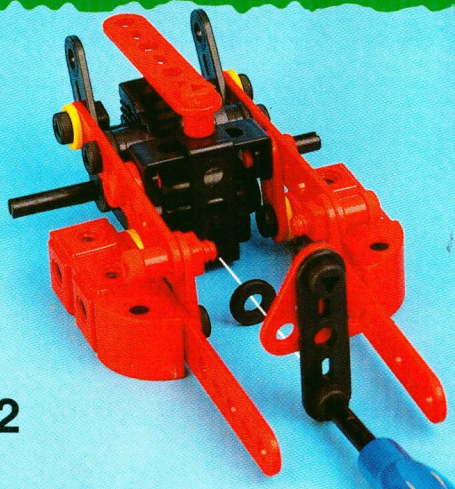

13

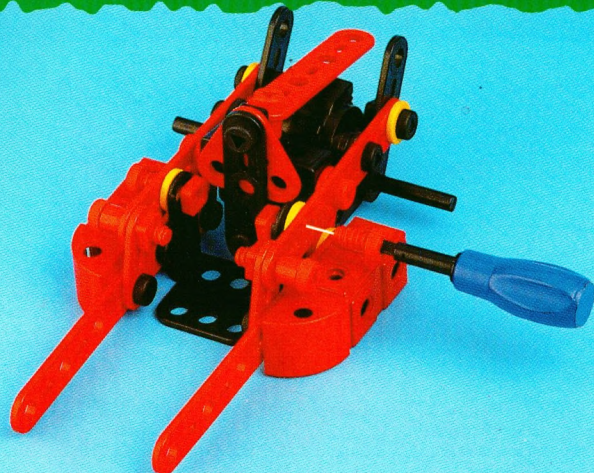
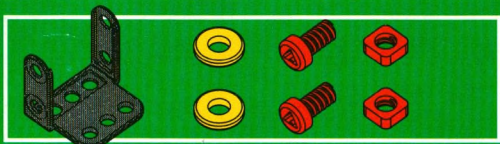

16

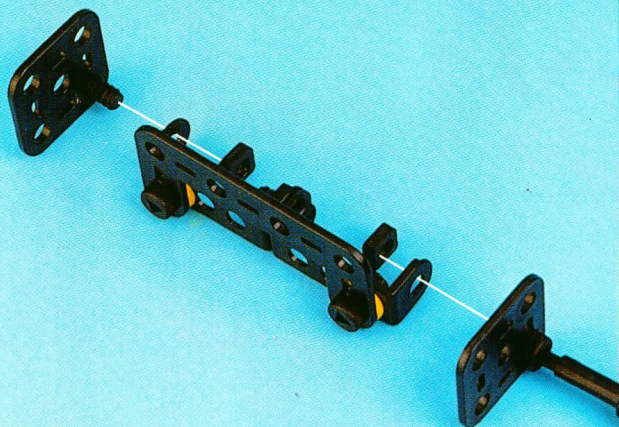
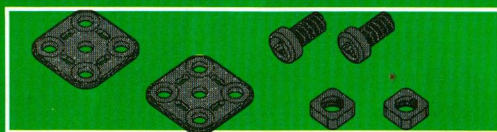

17

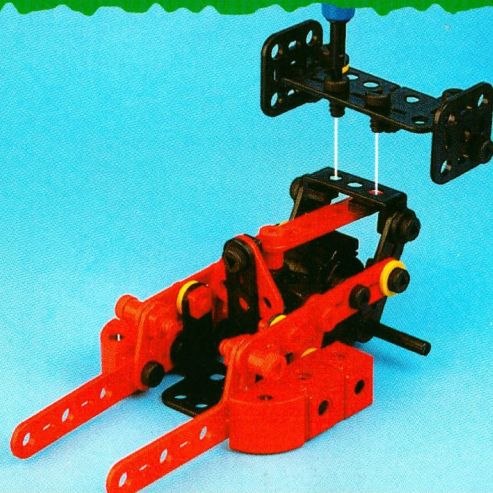
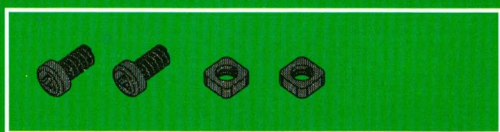

20

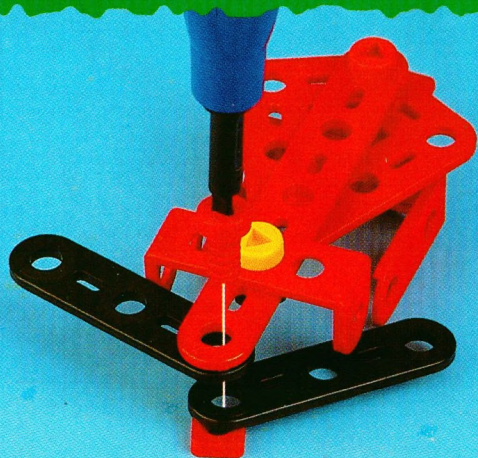

21

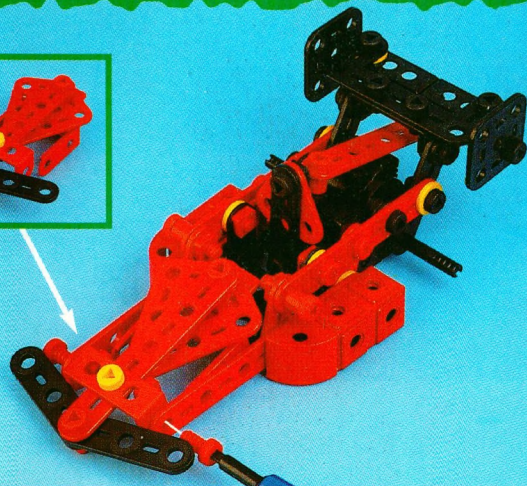
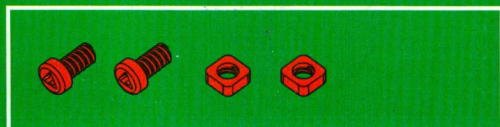

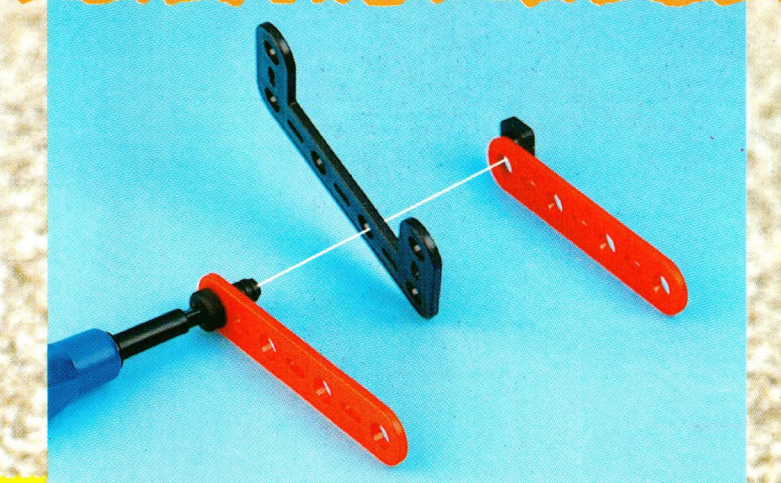
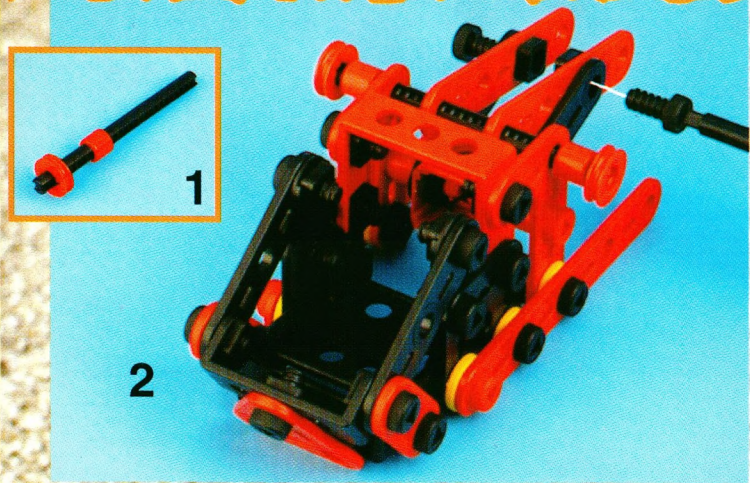
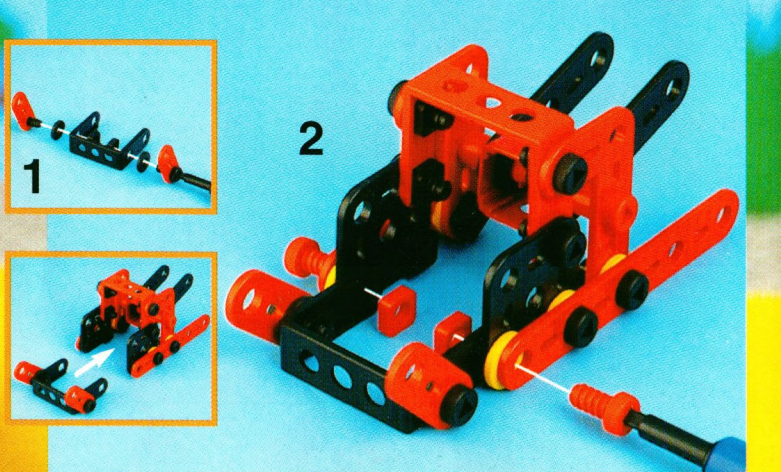
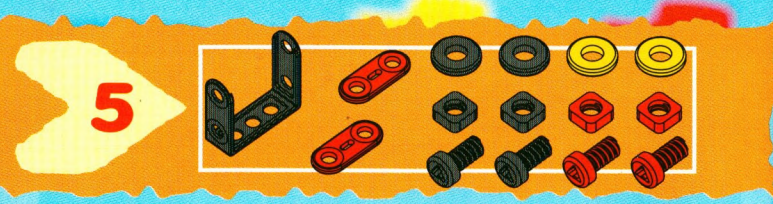
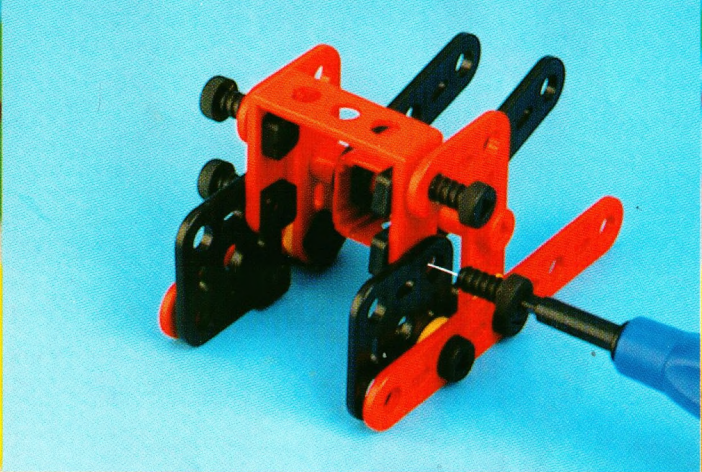
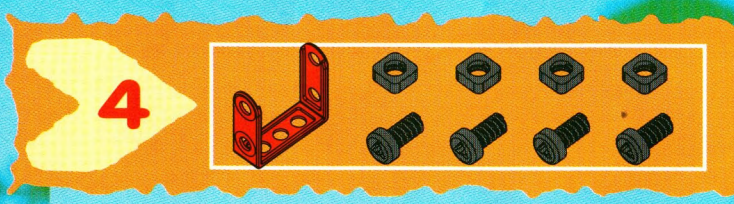
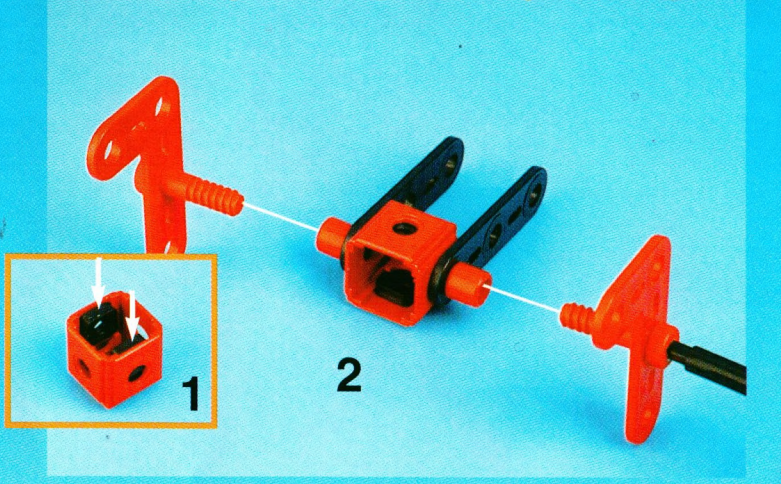
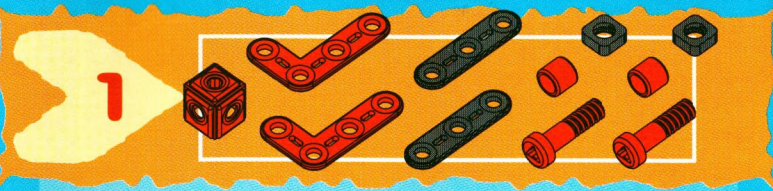

2

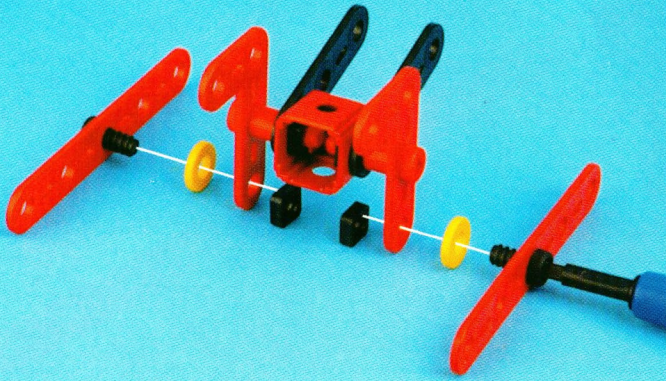
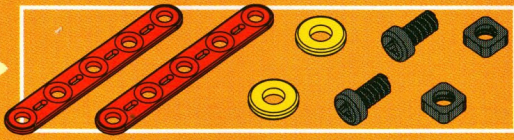

3

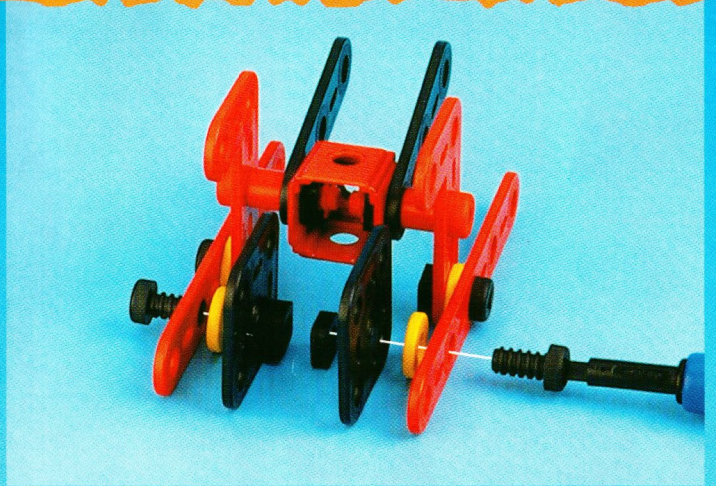
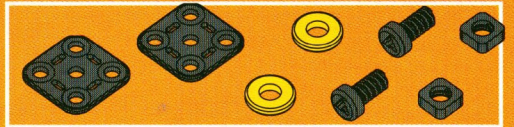

6

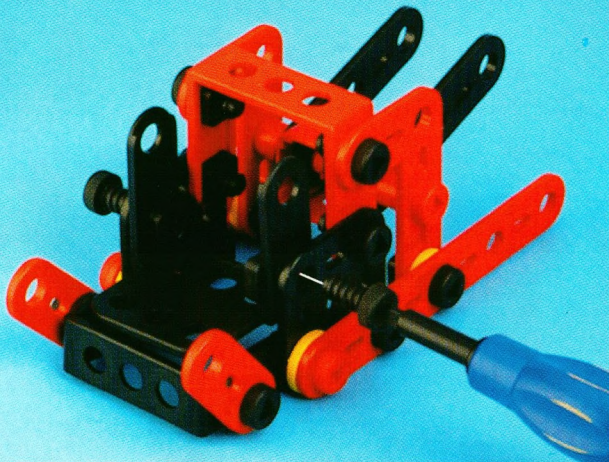
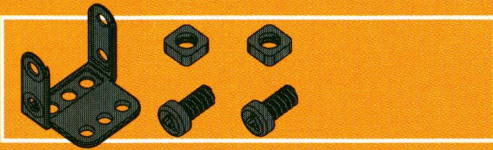

7

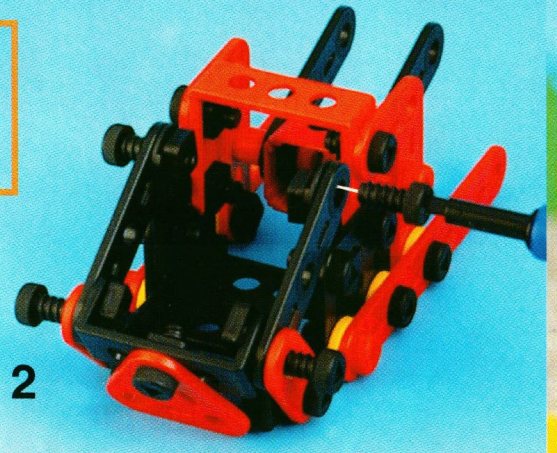
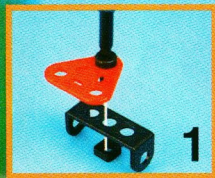

10

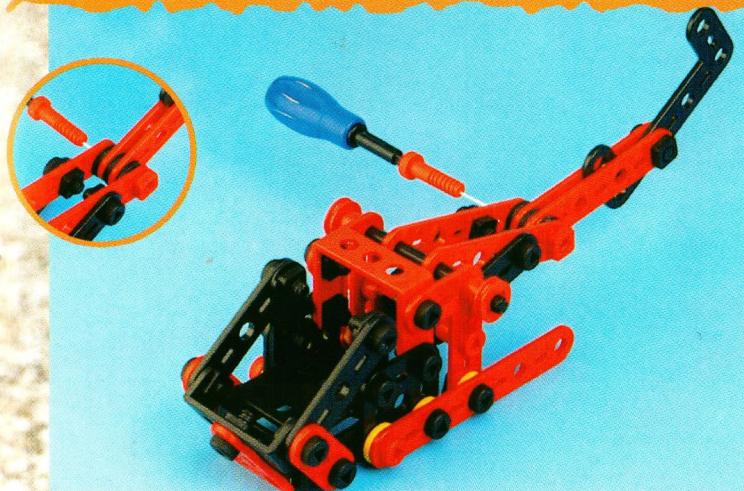
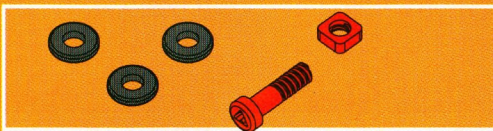

11

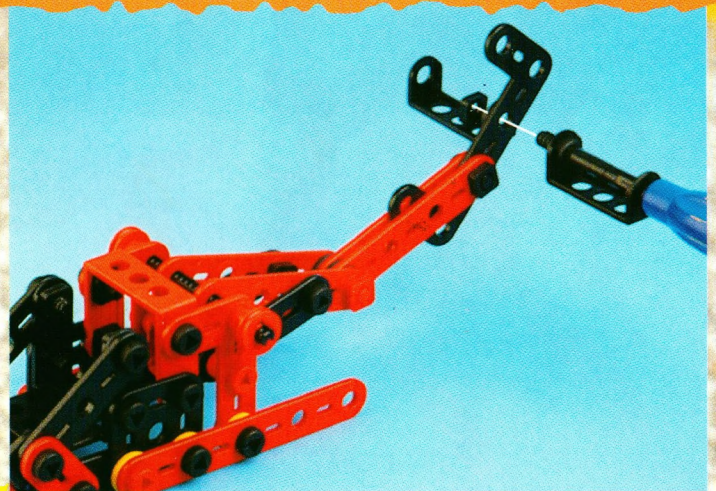
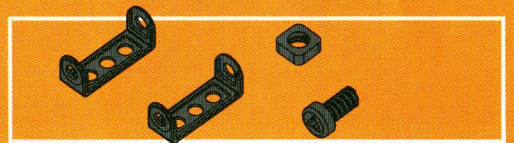

14

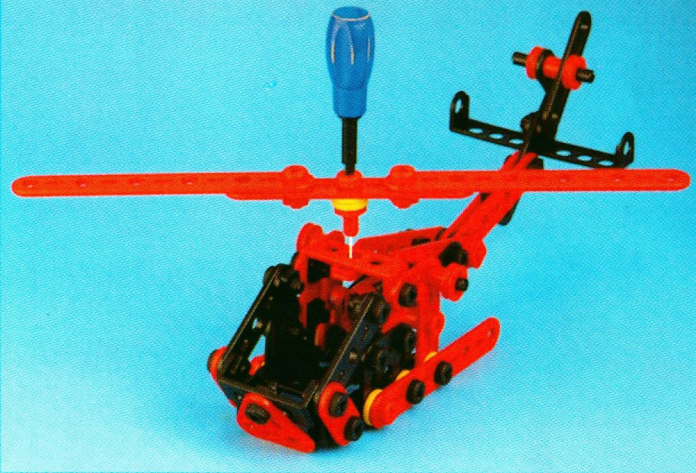

2

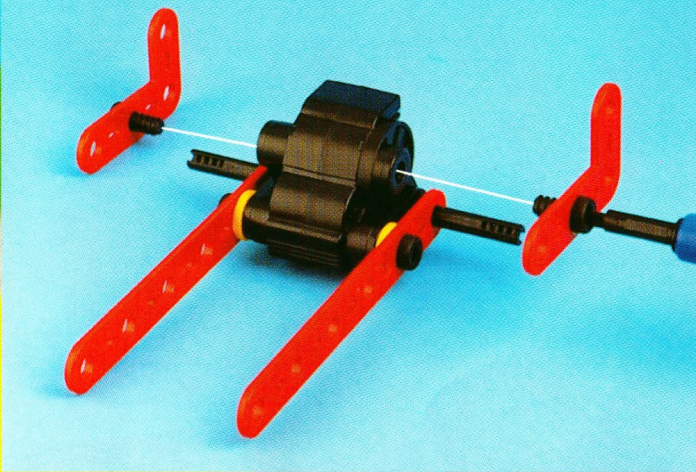
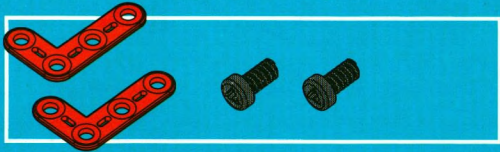

3

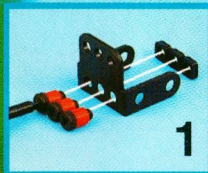

1

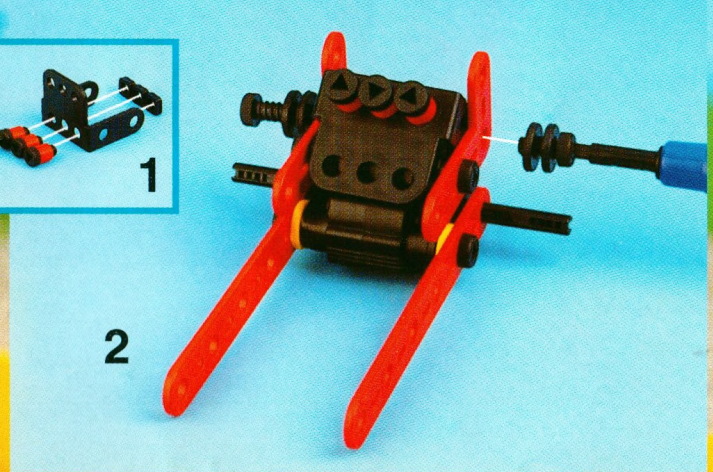

2

6

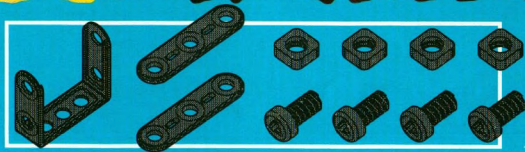

1

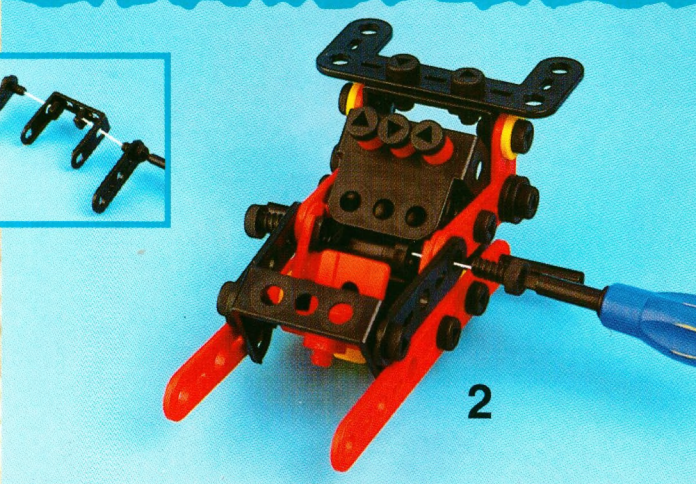

2

7

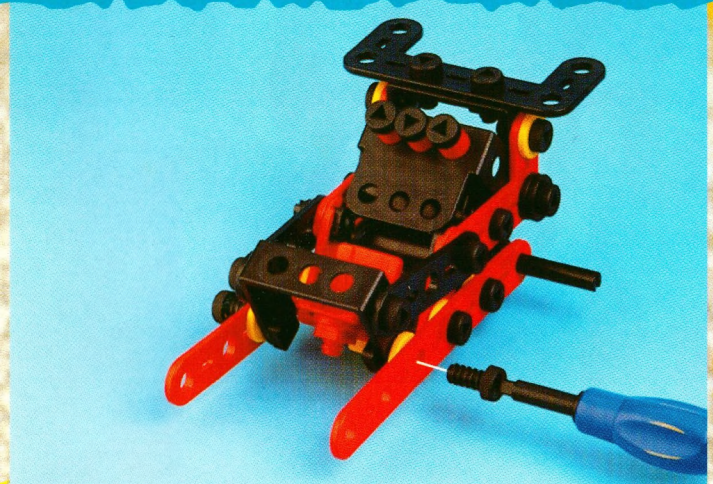
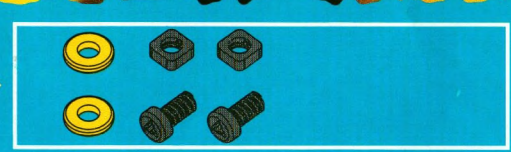

10



11

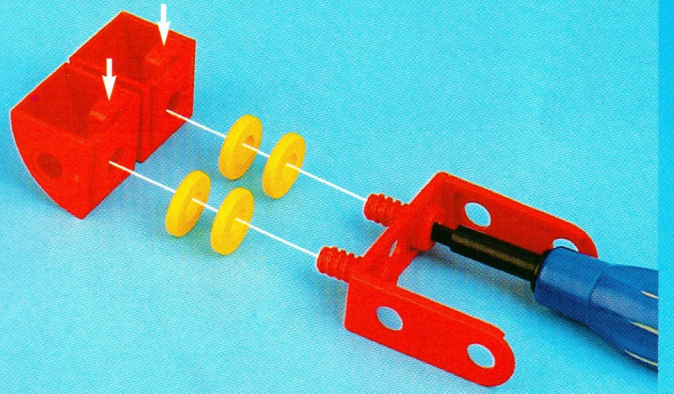
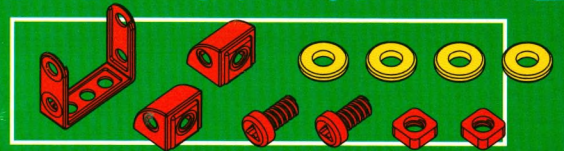

14

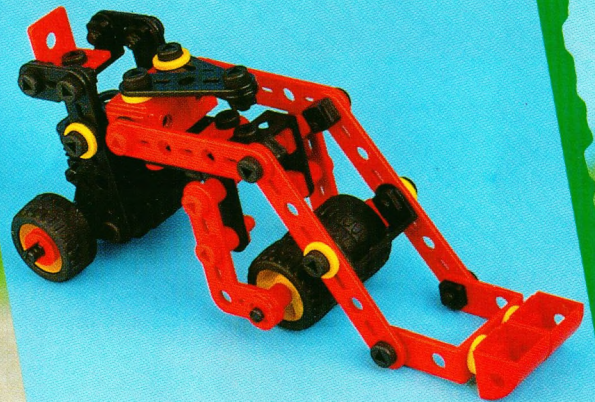
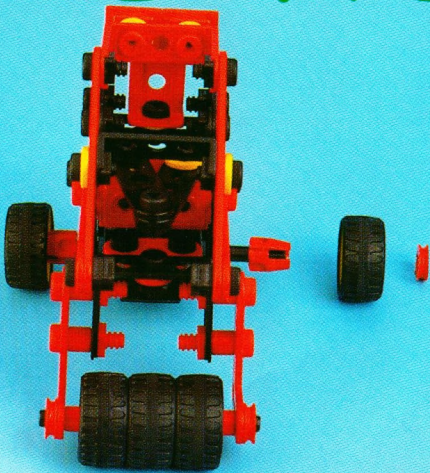
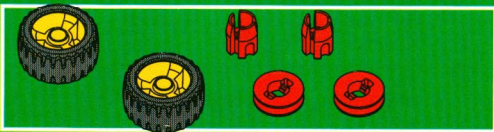

2

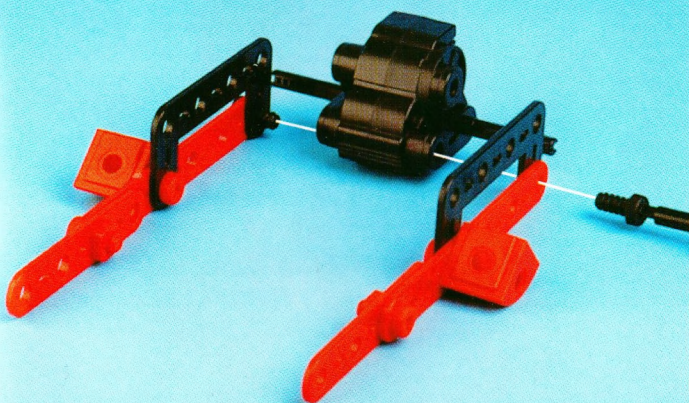

3

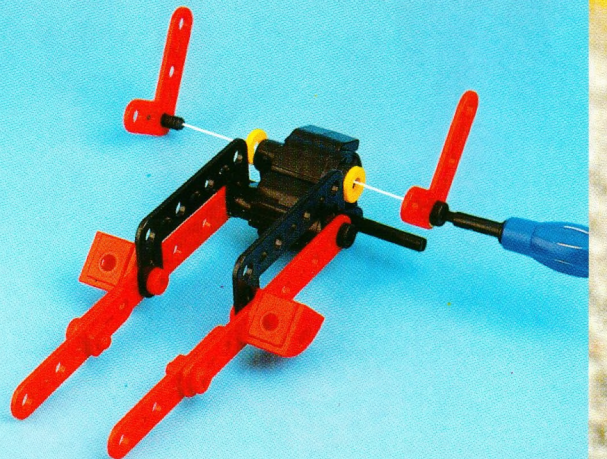

6



7

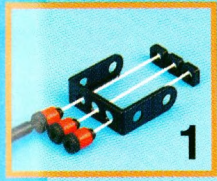

2

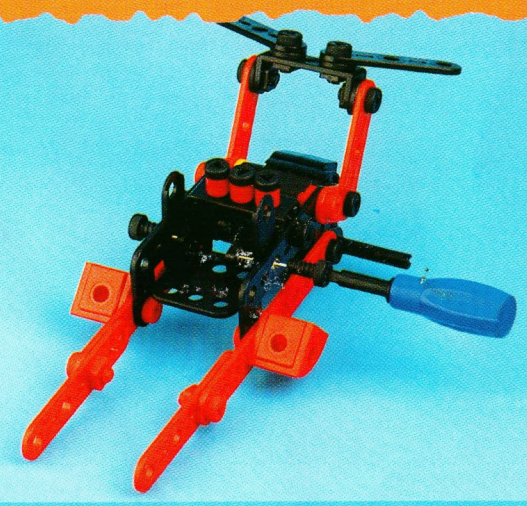
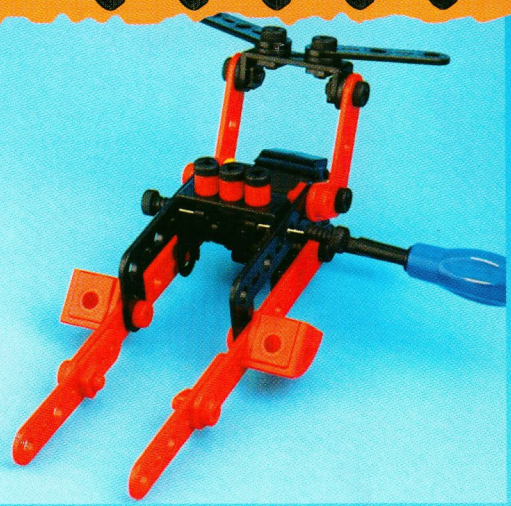

10

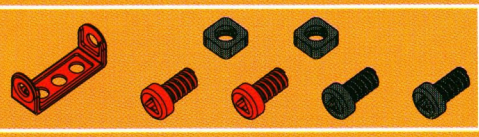

11



2

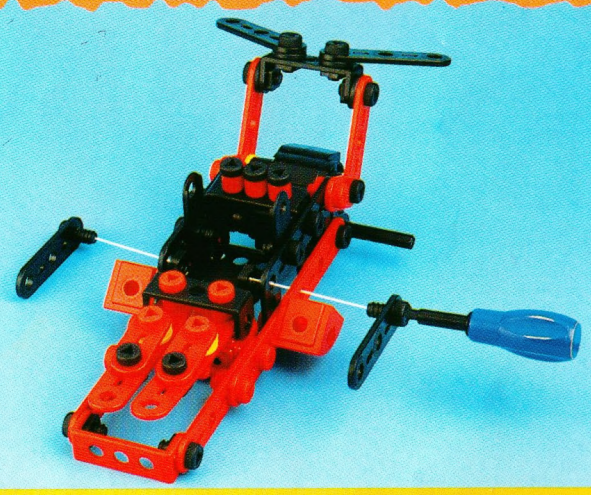

14

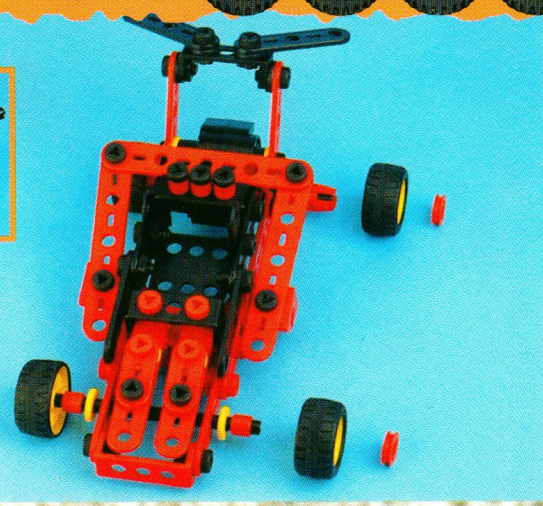

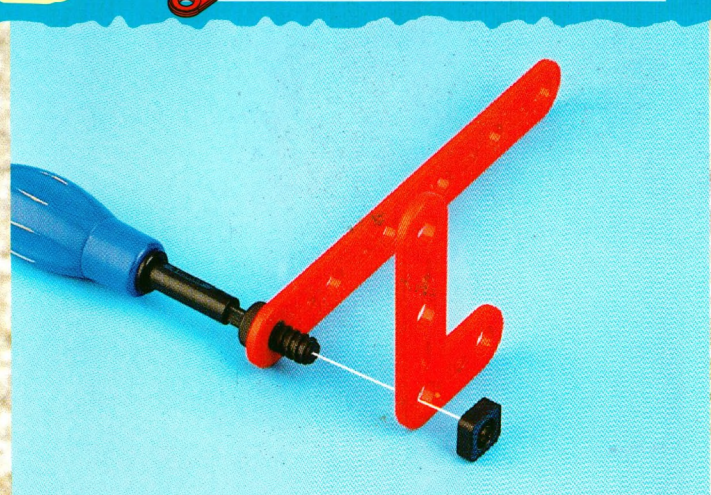
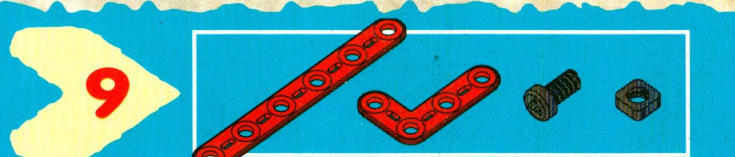
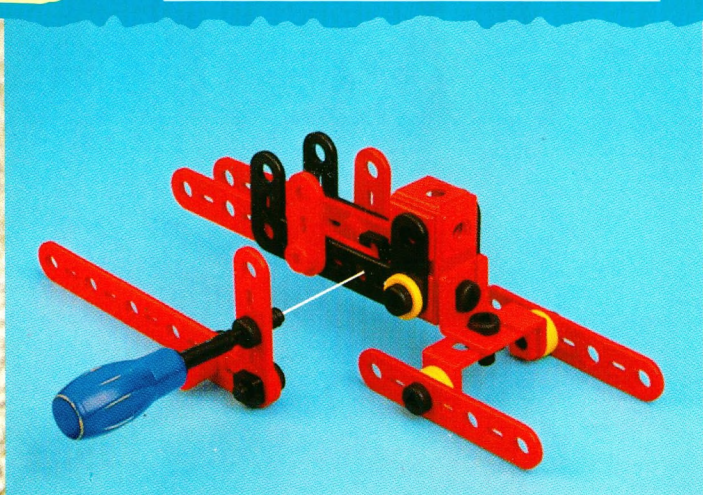
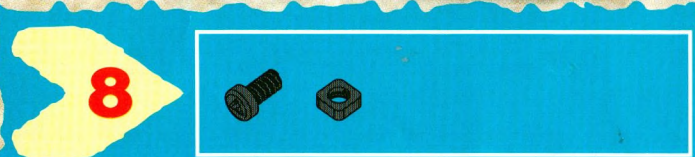
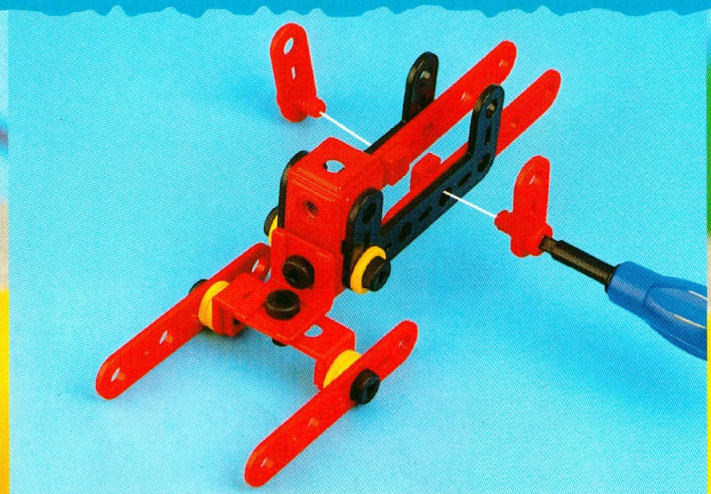
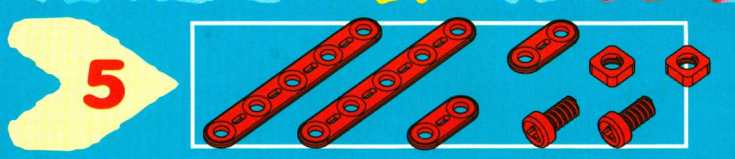
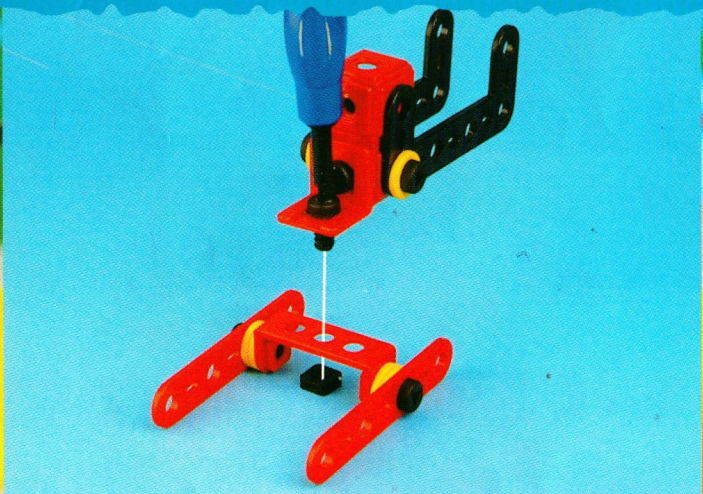
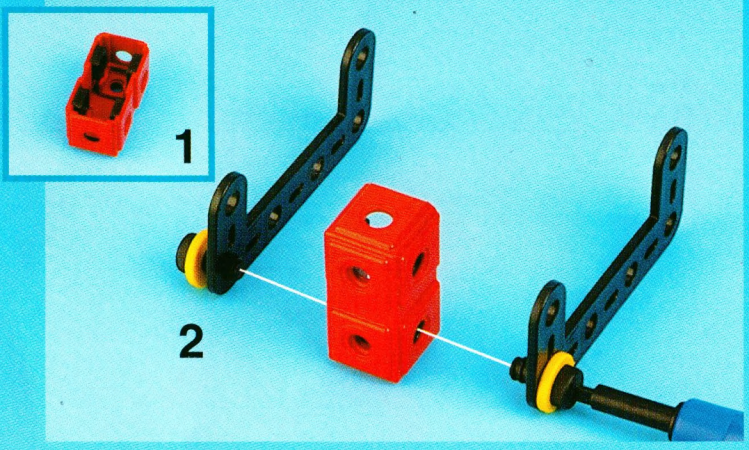
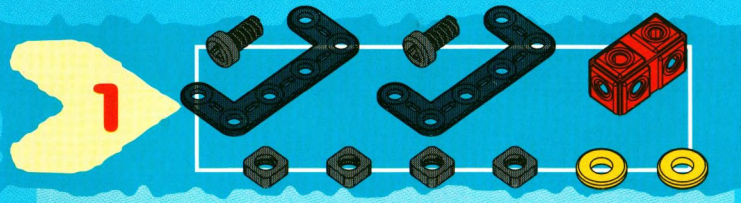

2

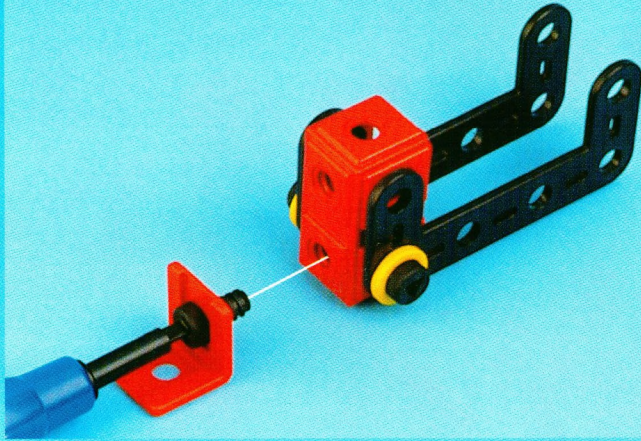

3

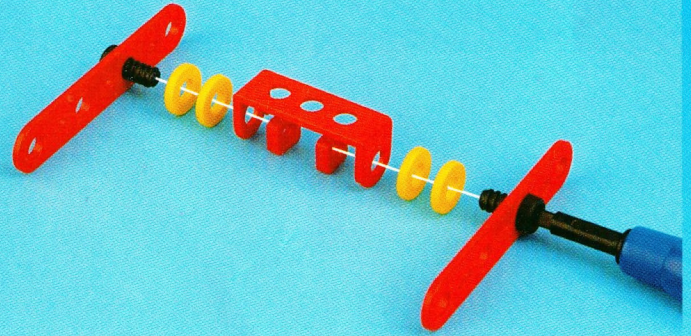

6

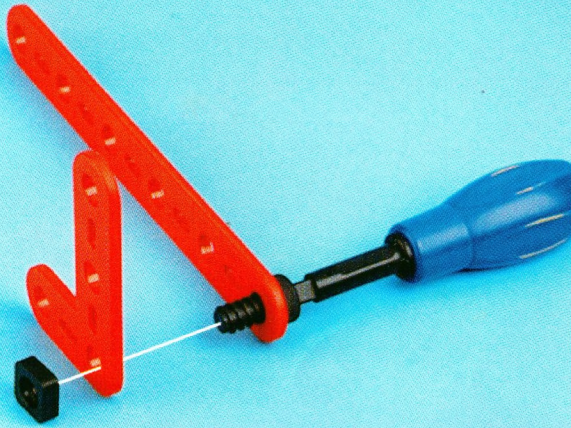
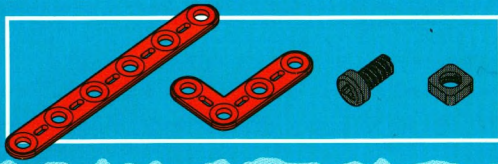

7

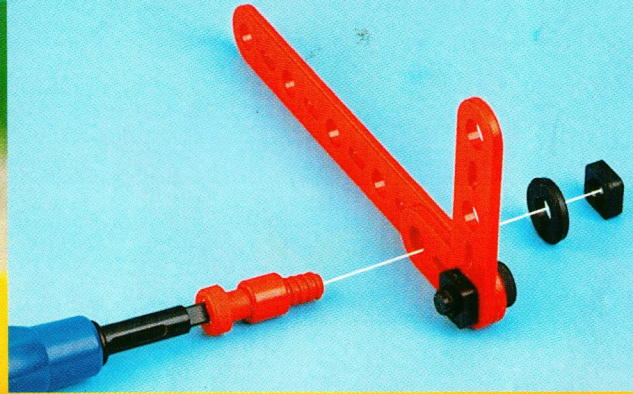

10

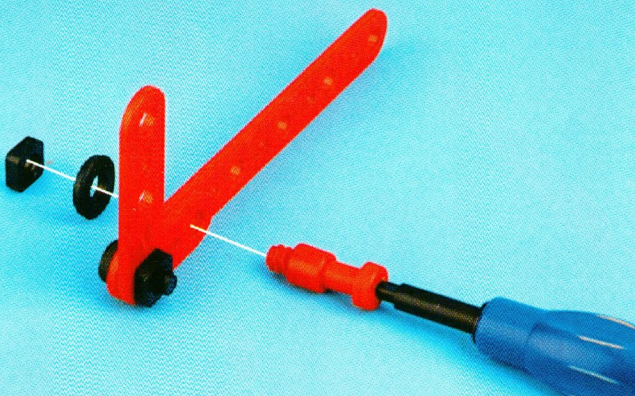

11

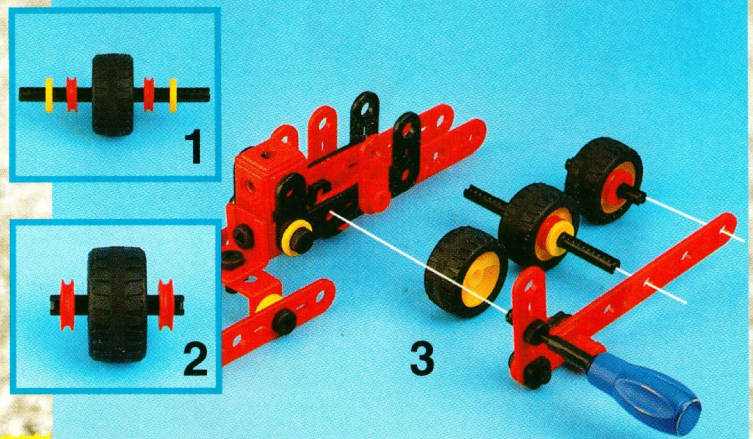

12

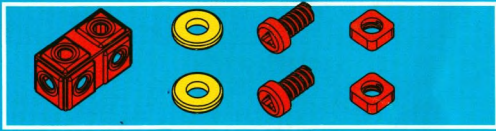

1

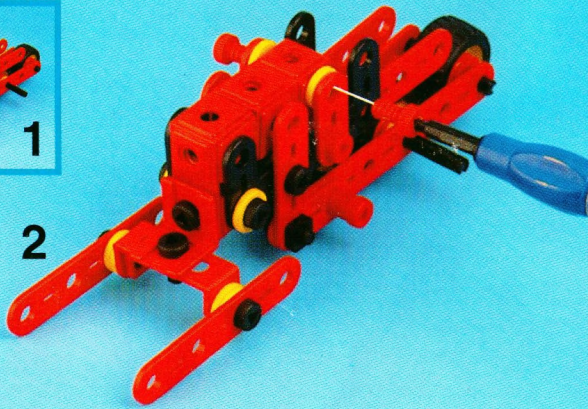

2

13

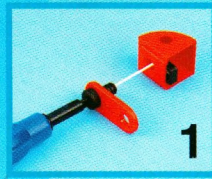
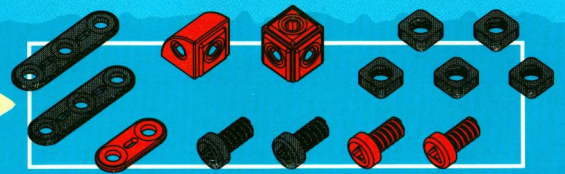

1

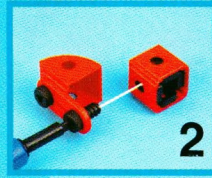

2

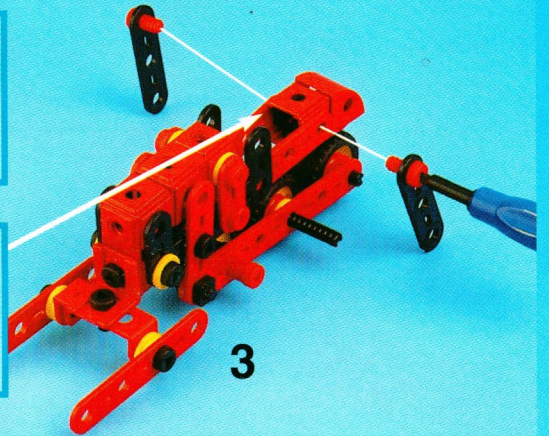

3

16

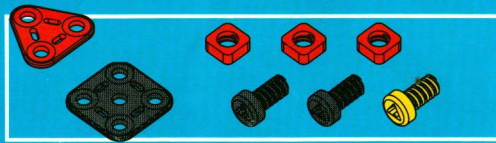

1



2

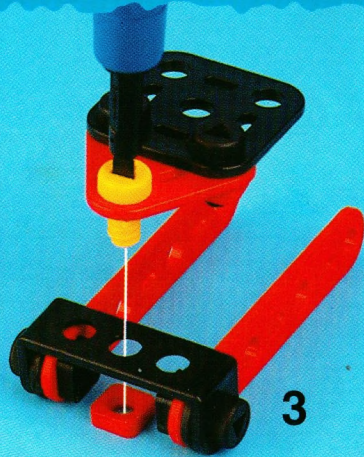

3

17

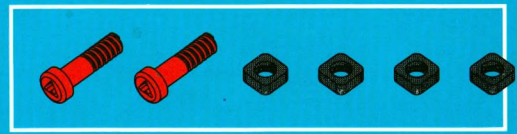

1

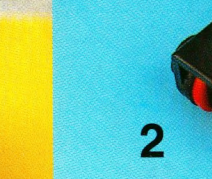

2

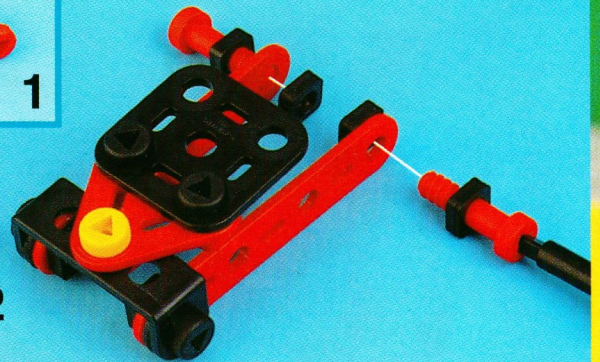

1

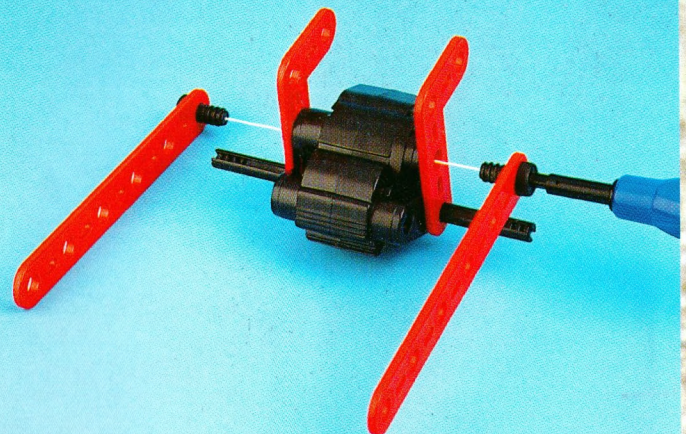
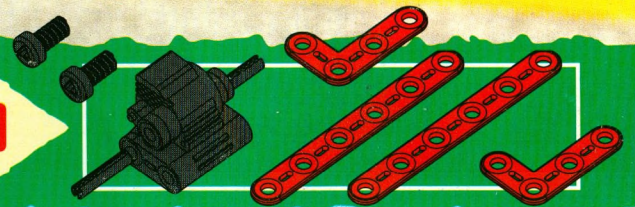

14

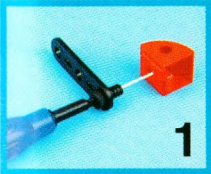
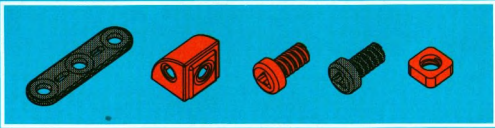

1

2

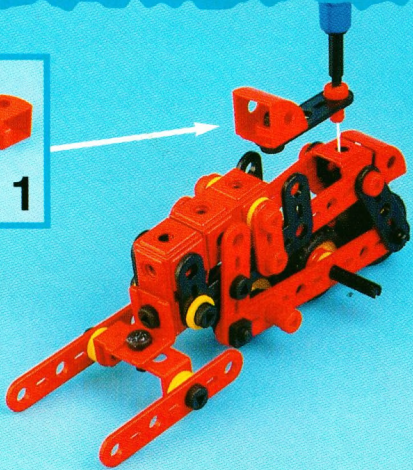

15

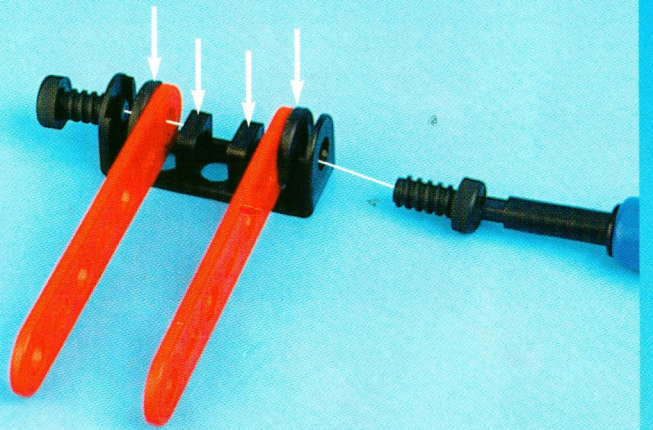
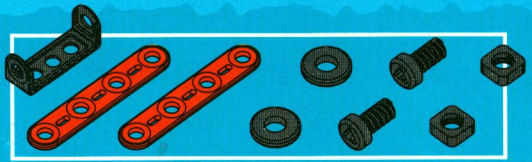

18

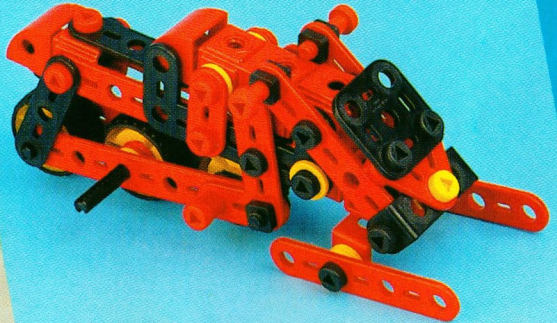
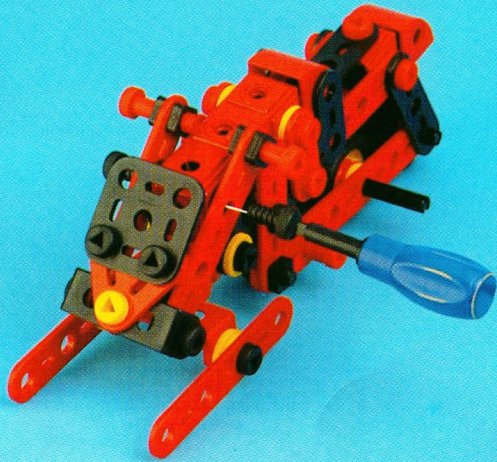

2

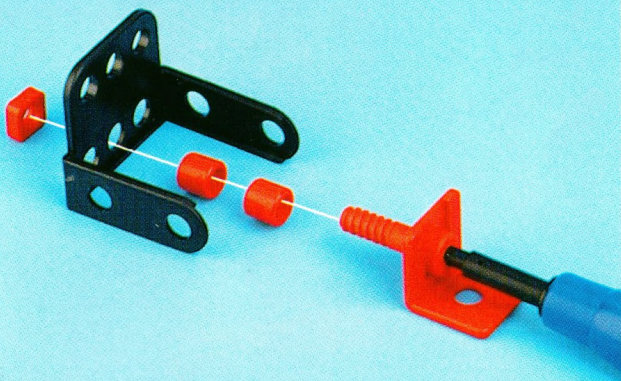

3

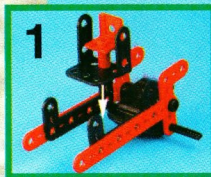

1

2

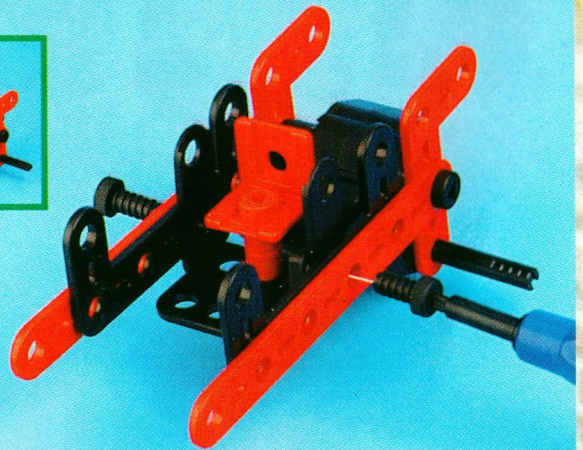

6

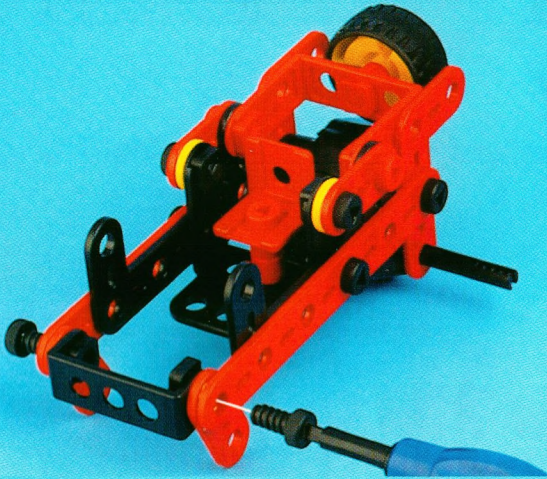
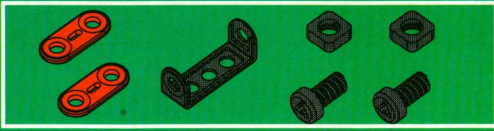

7

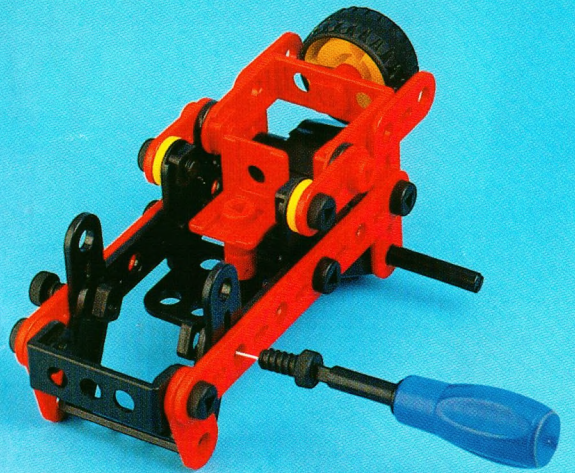
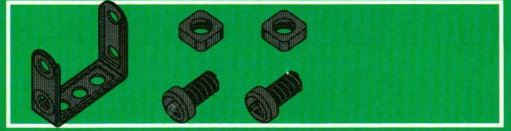

10

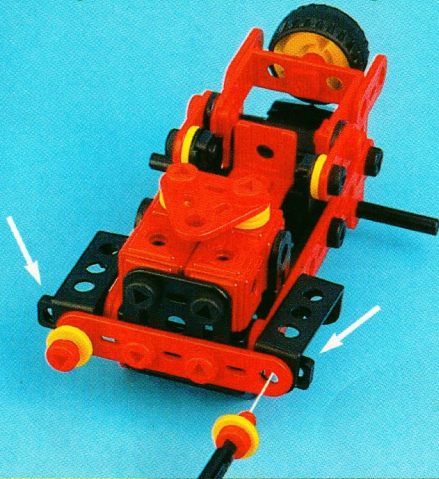

11

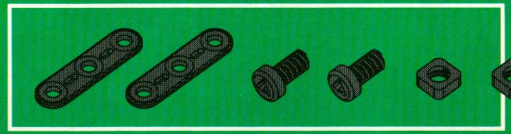

14

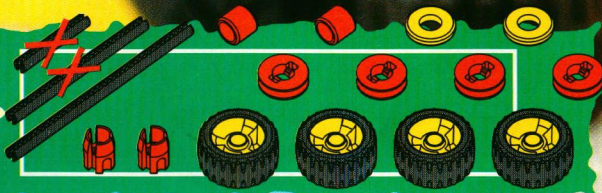

MECCANO® JUNIOR!



GB : Many of the models and component parts are unique and original designs which are the property of MECCANO S.A. They are protected by national legislation as industrial designs, trademarks and/or copyrights throughout many countries. For detailed information, please contact MECCANO S.A. MECCANO takes no responsibility where instructions have not been followed, where pieces have been put to uses other than those in the instructions, or have been modified for another use.

F : De nombreux modèles et pièces sont des créations originales, propriétés de MECCANO S.A. et sont protégés par les législations nationales sur les dessins et modèles, marques et/ou droits d'auteurs. Pour toute information, merci de contacter : MECCANO S.A. MECCANO se dégage de toutes responsabilités en cas de non-respect des indications de montage, utilisation des pièces pour un autre usage que celui indiqué dans les notices et/ou modification des pièces.

D : Zahlreiche Modelle und Teile sind Erfindungen und Eigentum der Firma MECCANO S.A. Sie sind durch Inland-Gesetze über Zeichnungen und Modelle sowie Warenzeichen und/oder Urheberrechte geschützt. Für zusätzliche Auskünfte wenden Sie sich bitte an : MECCANO S.A. MECCANO kann keine Haftung übernehmen, wenn die Anleitungen nicht befolgt oder wenn Teile anders als in den Anleitungen vorgesehen eingesetzt oder abgeändert werden.

I : Numerosi modelli e pezzi sono creazioni originali, proprietà della MECCANO S.A. e sono protetti dalle legislazioni nazionali sui disegni e modelli, marchi e/o diritti d'autore. Per qualsiasi informazione, vogliate prendere contatto con : MECCANO S.A. MECCANO non si assume alcuna responsabilità qualora le istruzioni non vengano seguite, le parti componenti vengano impiegate in modo diverso da quanto illustrato o siano state modificate per usi differenti dal montaggio dei modelli MECCANO.

E : Numerosos modelos e peças são criações originais, propriedades de MECCANO S.A. e são protegidos por las legislaciones nacionales en lo que concierne a los dibujos y modelos, marcas y/o derechos de autor. Para cualquier información, sírvase ponerse en contacto con : MECCANO S.A. MECCANO no se responsabilizará en aquellos casos en que no se hayan seguido las instrucciones, las piezas se hayan usado con distinto fin al indicado en las instrucciones, o bien se hayan modificado para otros usos.

P : Numerosos modelos e peças são criações originais, propriedades de MECCANO S.A. e são protegidos pelas legislações nacionais segundo os desenhos, os modelos, as marcas e/ou os direitos autorais. Para quaisquer informações, queira contactar : MECCANO S.A. MECCANO não assumirá nenhuma responsabilidade sempre que as instruções não tenham sido seguidas, as peças tenham sido utilizadas noutros fins que não os contidos nas nossas instruções, ou tenham sido modificadas para outras utilizações.

S : Många modeller och delar bildar en unik och originell formgivning vilken är MECCANO S.A. egendom. Dessa modeller och delar är skyddade genom lagstiftning såsom industriell formgivning, varumärke och/eller upphovsmanrätt i ett flertal länder. För mer detaljerad information, var vänlig och kontakta MECCANO S.A. MECCANO kan ej ta ansvar för något då instruktionerna ej har följts, då delar har använts till annat än vad instruktionerna anvisat eller att delarna har blivit modifierade till annan användning.

FIN : Vore mange modeller og dele er originale fremstillinger og ejes af MECCANO S.A. Tegninger, modeller, fabrikmærker og ophavsret er lovbeskyttede i hvert land. Yderligere oplysninger kan fås hos : MECCANO S.A. MECCANO ei ota vastuuta, jos osia on käytetty muuhun kuin ohjeiden suosittelemaan käyttötarkoitukseen tai jos osia on itse muutettu.

DK : Useat mallit ja osat ovat MECCANO S.A.:n omaisuutta olevaa suunnittelua. Useat mallit osat ovat lailla suojattua teollista tuotantoa, tavaramerkkejä ja/tai kopiointioikeuksia useissa maissa. Tuotemerkki MECCANO on MECCANO S.A.:n omaisuutta oleva rekisteröity tavaramerkki, jonka käyttö ilman lupaa on kielletty. Lisätoivoja varten, ottakaa yhteyttä MECCANO S.A. MECCANO fratager sig ald ansvar, hvis materialet bliver brugt til andet end det beregnede, når anvisningerne og forandringerne af delene ikke overholdes.

NL : Veel modellen en onderdelen zijn een uniek en origineel ontwerp, hetgeen eigendom van MECCANO S.A. is. Deze modellen genieten bescherming als industrieel ontwerp, handelsmerk en/of copyright in talloze landen. Voor uitgebreide informatie, s.v.p. contact opnemen met MECCANO S.A. MECCANO is niet verantwoordelijk voor het niet opvolgen van de instructies, voor verkeerd gebruik van de onderdelen of het gebruiken van onderdelen voor andere doeleinden.

GR : Πολλά μοντέλα και ανταλλακτικά είναι αυθεντικά, ιδιοκτησία της MECCANO A.E. και προστατεύονται από τις εθνικές νομοθεσίες για τα μοντέλα, τις μάρκες ή τα διπλώματα ευρεσιτεχνίας. Για κάθε πληροφορία παρακαλώ απευθυνθείτε στην MECCANO A.E. Η MECCANO δεν φέρει καμία ευθύνη σε περίπτωση που δεν τηρηθούν οι οδηγίες συναρμολόγησης, σε περίπτωση που τα συναρμολογούμενα κομμάτια χρησιμοποιούνται για άλλη χρήση από εκείνη που αναφέρεται στις οδηγίες χρήσης και/ή σε περίπτωση που τροποποιηθούν.

JPN : モデルならびに部品は、その多くがメカノ社所有のオリジナルデザインで、意匠・商標および/または著作権に関する国内法によって保護されています。詳細については、メカノ社 (MECCANO S.A.) までお問い合わせをお願いします。指定の組立方法に従わない場合や説明書にない用途に部品を用いた場合、また部品を改造した場合、メカノはその責任を一切負いません。