



BOOK OF MODELS
VOYAGE DE MOSES
LENA DE MICHIELLI
MONTAGNA
LENA DE MICHIELLI
LENA DE MICHIELLI
MODELLI
9

Special virus free issue

June 2020

Inside

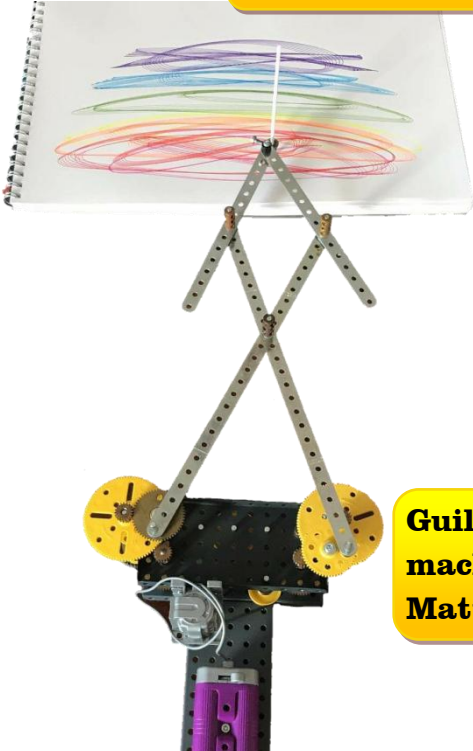

Guilloché drawing machine by Matthew Auger

Page 6



Meccanovirus

Georg Eiermann

Lots of covid-19 models are being built by Meccanoboy in home isolation.

Page 9

With no club meetings and no exhibitions due to the coronavirus I've had to dig deep to fill the 16 pages. Hopefully this special virus-free edition will find you safe and help to brighten up your day - John.



Page 3

N20 motors by Doug Hedgley



How Graham Jost eats his spaghetti



Yet another Braider! Graham Jost

Page 7



Salvage the LEDs from light bulbs Peter Sullivan

Page 8



This Month's Meccanoboy is Keith Campbell Northern Ireland

Page 14



Mars Rover Arcade Simulator

by Stuart Weightman

Page 10



More

THUNDERBIRDS

POD SELECTOR

See how to

1. Build a Joystick control
2. Build a Linear Actuator
3. Raise your TB2 up and down
4. Make a catch and release system for the Pods



This is still a work in progress so let's get started with Part 1 and hopefully I'll have Part 2 ready for the next issue.

Part 1



See the original Thunderbird 2 launch sequence here

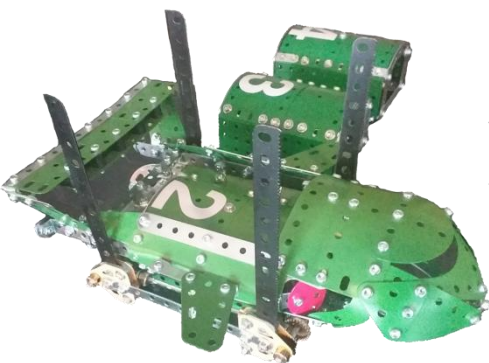

I started thinking of ways to raise and lower the Thunderbird 2 just like they did on the TV series in the '60s. (You can see a short video clip of the liftoff sequence by clicking on the YouTube link to the right.) My first thought was to copy the telescopic rods that are used but after ordering a lot of various sized brass tubes and trying to make it work, I lost heart and put it into the 'too-hard' basket.

YouTube <https://youtu.be/IMEuEF9-UbU>

Then I remembered a Rack Strip ram drive using a part 160 Channel Bearing that Richard Payn once showed me. It was far too big to bolt unobtrusively to the sides of the Thunderbird so I set about designing a smaller version. What I ended up with actually became a very useful linear actuator that has a host of applications in addition to lifting the Thunderbird. Douglas Hedgley used one of these to open and close the hatch on his loco. My linear actuator has an N20 geared motor hanging out the side with a Coupling used to connect to the Tri-Axle which is necessary to drive the plastic bossless 19t Gear in between the Trunnions.

You can watch the linear actuator in action in my YouTube video. Link below

YouTube <https://youtu.be/6hTXFkXZiNu>

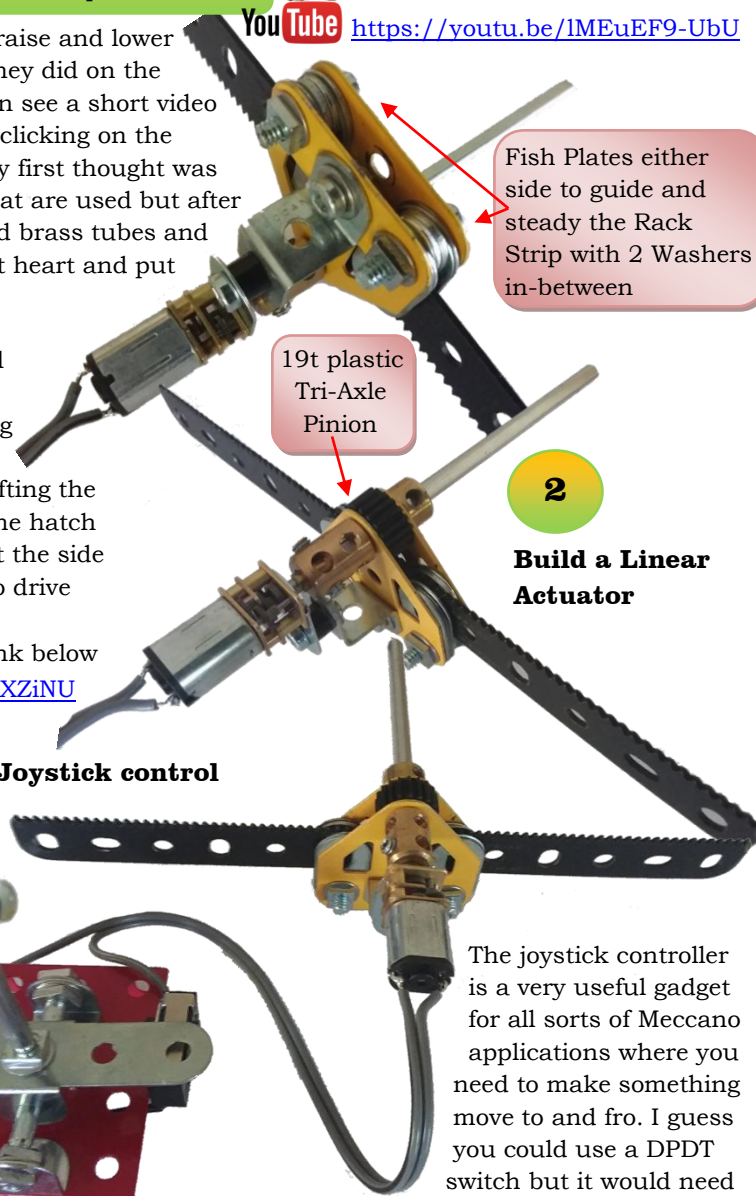

Fish Plates either side to guide and steady the Rack Strip with 2 Washers in-between

19t plastic Tri-Axle Pinion

2

Build a Linear Actuator

1 Build a Joystick control

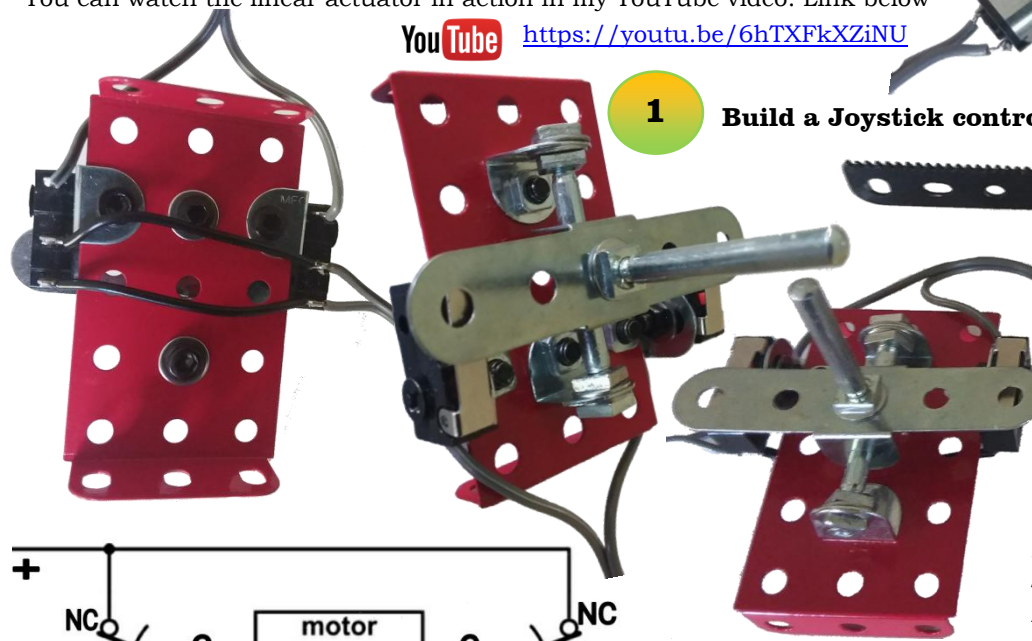

The joystick controller is a very useful gadget for all sorts of Meccano applications where you need to make something move to and fro. I guess you could use a DPDT switch but it would need

to have Centre Off and Momentary action. This seems to be a much nicer Meccano version and uses 2 microswitches wired as shown in the circuit diagram to the left. In the photo you can see the motor is connected to the Common lugs, +12V is connected to both Normally Closed lugs and -12V is connected to both Normally Open lugs. (Or vice versa).

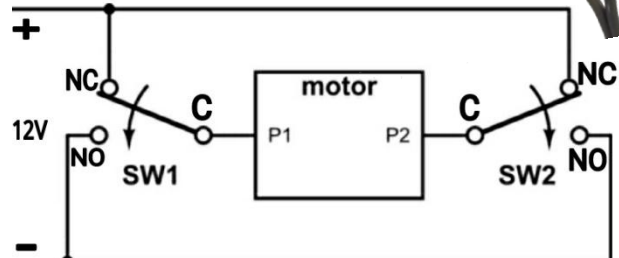

The rocking could be limited by bolts if you wanted to make it kid proof.

Having built your Trunnion Rack Strip Ram Drive and Joystick Controller you can have a go at this prototype Thunderbird lifter but as this project advances (hopefully next issue) the mechanisms will not be mounted on the Thunderbird as, although it works, it's a bit wobbly. Build four of the drives as shown below and test each one individually. It's important to make sure the Tri-Axles run at perfect right angles otherwise they won't run freely when you join them with the Part 213d Rod Connector. The left and right mechanisms are mounted to the fuselage using 12d Obtuse Angle Brackets. There is a part 12 Angle Bracket on the outside of the Trunnions and the 12d goes over the Trunnion. This is done to give the Rack Strip something to slide along as it tends to rock a bit due to the washers between the Fishplates being not quite close enough to the back of the Rack Strip. Test it without the pinion on the motor so that you can wind it up and down with your fingers on the 1" gear. If the front is lower or higher than the rear you can adjust the front 26n Pinion. If the left is higher or lower than the right you will have great difficulty adjusting it due to the Tri-Axle limiting the positions. I eventually had to gently pull the Tri-Axle out and carefully move the plastic Pinion up one tooth on the Rack Strip.

To make the pod lock into place I've designed a mechanism using springs, Pawls and Cranks. The Pawls are held horizontal by the tension spring pulling the Bolt in the Crank onto the Angle Bracket. They are free to move down as you push the pod down and flick back up when the pod passes them. The Pawls can be released to free the pod by pushing the Rods in which allows the Pawls to move up as the Bolt on the Crank is no longer restrained by the Angle Bracket.

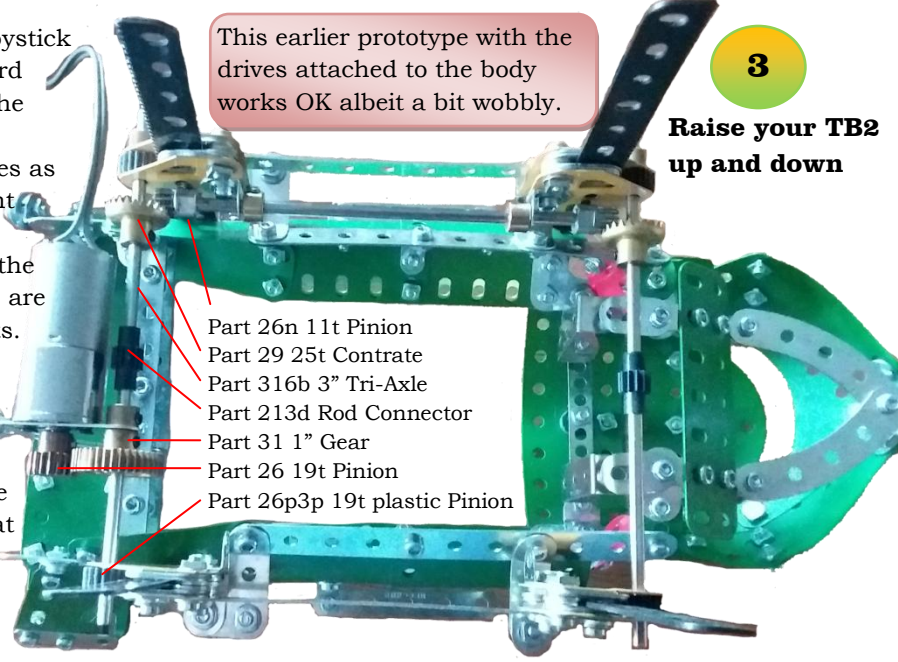

This earlier prototype with the drives attached to the body works OK albeit a bit wobbly.

3

Raise your TB2 up and down

- Part 26n 11t Pinion
- Part 29 25t Contrate
- Part 316b 3" Tri-Axle
- Part 213d Rod Connector
- Part 31 1" Gear
- Part 26 19t Pinion
- Part 26p3p 19t plastic Pinion

Sorry if the photo is not very clear but the YouTube video will show you how it works with crystal clarity

YouTube <https://youtu.be/luBdNaJyzxs>

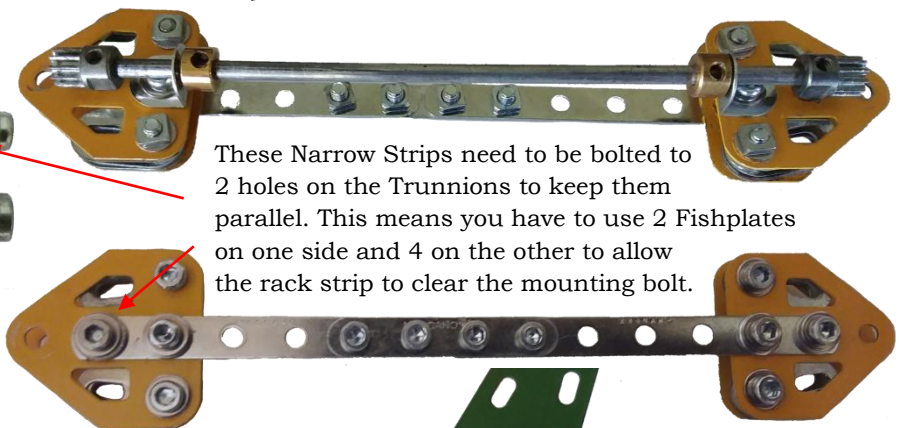

These Narrow Strips need to be bolted to 2 holes on the Trunnions to keep them parallel. This means you have to use 2 Fishplates on one side and 4 on the other to allow the rack strip to clear the mounting bolt.

4 Make a catch and release system for the Pods

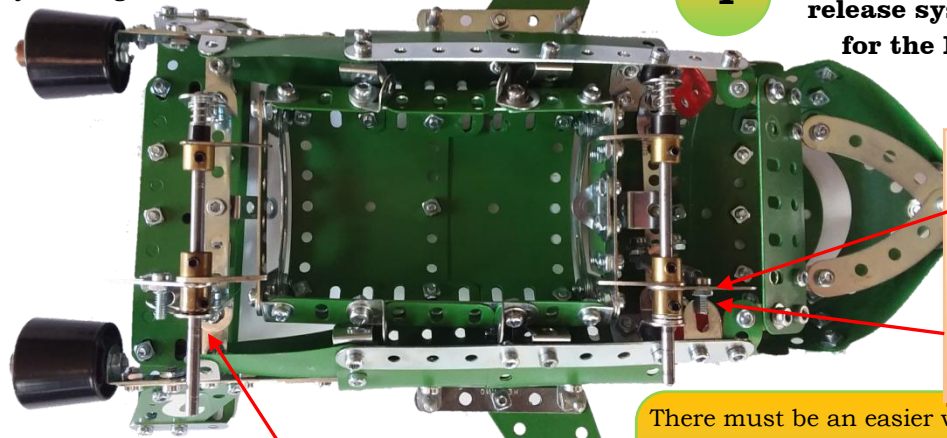

The rear is the reverse of the front

- Compression Spring
- Bossed Pawls
- Crank
- Bolt on Crank sits on top of Angle Bracket and is released when Rod is pushed

There must be an easier way to lock the pod in. If you have any ideas, give it a try and send your pics to MeccanoNews@gmail.com

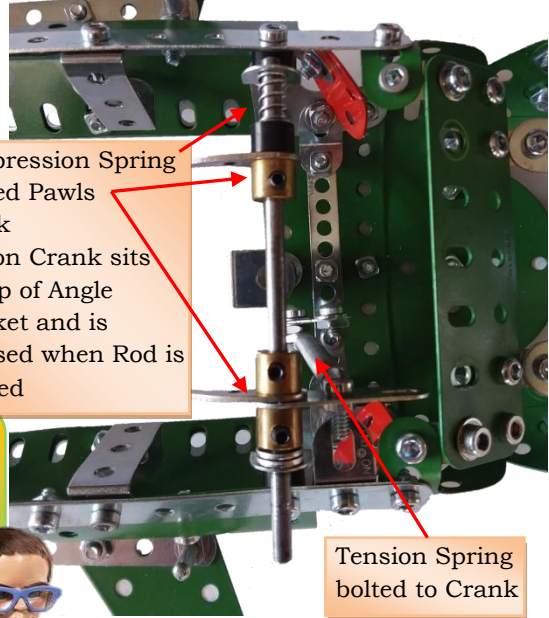

Tension Spring bolted to Crank

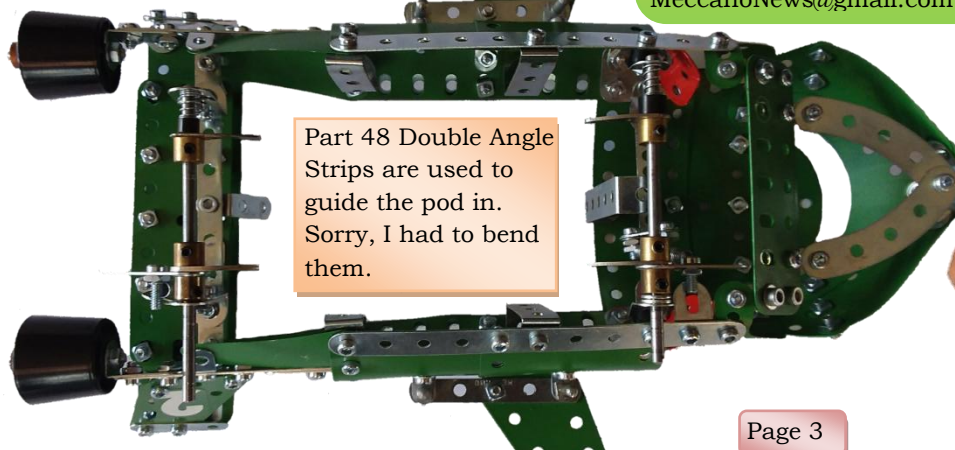

Part 48 Double Angle Strips are used to guide the pod in. Sorry, I had to bend them.

Part 2 next issue

I already have the pod track and lifting system built and the Thunderbird is now able to be lifted off the mechanism which is now bolted to the track. I will start working on the pod selector system..... as soon as I think of a way to do it!



N20 Geared Motors by Douglas Hedgley



With the relatively recent availability of powerful tiny motors it is now very easy to distribute your motive power requirements with individual motors rather than a single motive power source distributed around the model using shafts, bearings and gearboxes. These motors are designated N20 and have high torque outputs from their integral gearboxes in the popular 6-12V range and at a commendably low price of approximately £1 they are excellent value for money. However, once they arrive (usually from China) there is a small problem of their output shafts being 3mm in diameter whereas we need 4mm as a suitable modern size before we can use them on our Meccano models. A modification has to be performed to make them usable. The following shows how I went about it, but be warned, it is controversial!

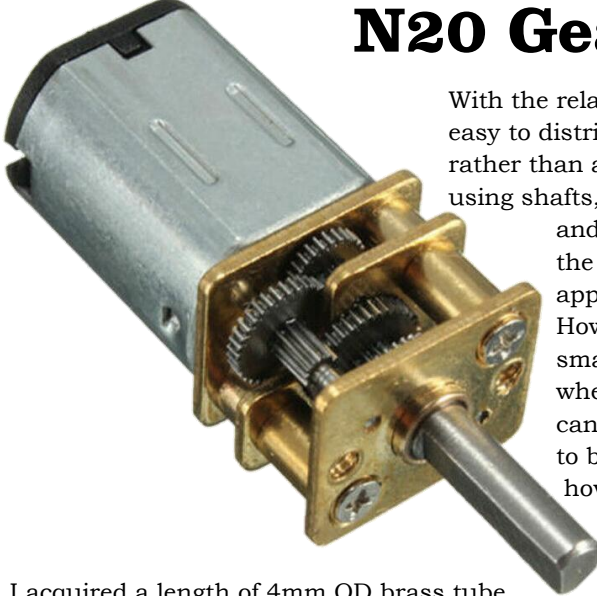

I acquired a length of 4mm OD brass tube from B&Q in the UK but any good hobby store should carry it and I proceeded to cut it into pieces, each one long enough to cover the length of the motor output shaft less a couple of millimetres. The motor was then mounted into the vice between two old angle girders to both protect the motor from the rough jaws of the vice and to hold it firmly, but without undue pressure. A piece of cord was tied around the shaft where it meets the gearbox. I used old scrap pieces of Meccano cord as it's the perfect size but other makes are available. The brass tube was eased over the shaft and tapped gently down to meet the cord, hence the mention earlier of the tube length being a couple of millimetres shorter than the motor shaft! Solder was to hand ready to be fed down the tube once it reached flow temperature.

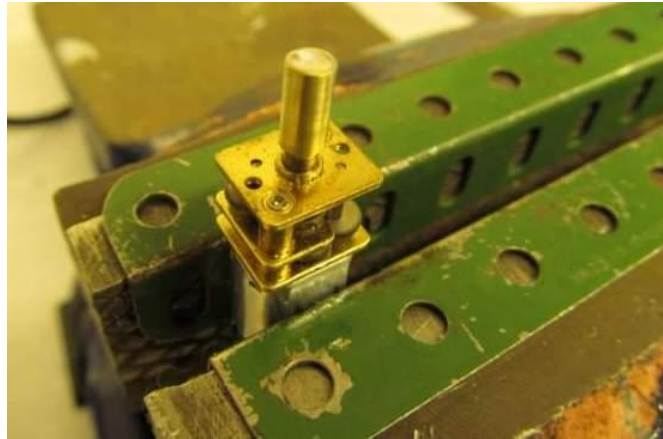
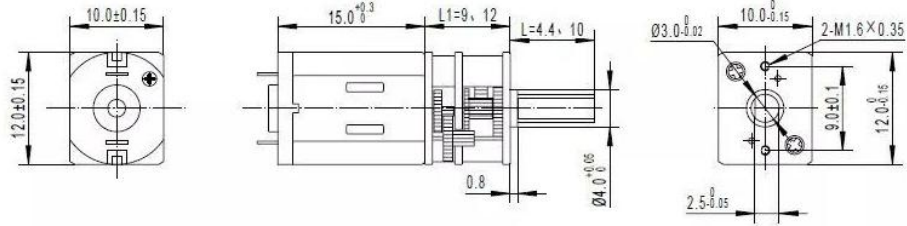

The dimensions of these tiny motors are 12mm by 10mm front on with the length being 15mm for the can motor plus 10mm for the gearbox and 10mm for the shaft.

NOW HERE'S THE CONTROVERSIAL POINT!

I used a blow lamp to heat everything and get the solder flowing BUT it's not for everyone. My reasons for this method are quite simple. I have been in the electrical control world all my working life and am very experienced in making good solder joints on the huge ring terminals we use from time to time. I know where and for how long to place the flame to get the solder to flow and attach without a dry joint ensuing or melting the motor windings! Johnny Meccano reckons it's overkill and he's not wrong! So I would strongly suggest that a suitable soldering iron is used and held in the hole of the tube when it's not fully tapped down on the shaft. Then feed the solder in. However you need to leave the soldering iron on the work piece long enough to get the solder to flow smoothly between the tube and shaft WITHOUT leaving it there so long that it eventually heats the motor up to unacceptable temperatures and dries the solder. Luckily the vice acts as a heat sink which helps with the overheating aspect. With your third hand, tap the brass tube fully down to become flush with the open end of the shaft BEFORE the solder stops flowing. It might sound a bit complicated or fiddly but it's actually quite straight forward. The cord, or the remains of it, can now be removed and the reason for the cord? It was to keep any solder from getting down the shaft into the mini-gearbox, which would have been bad news.

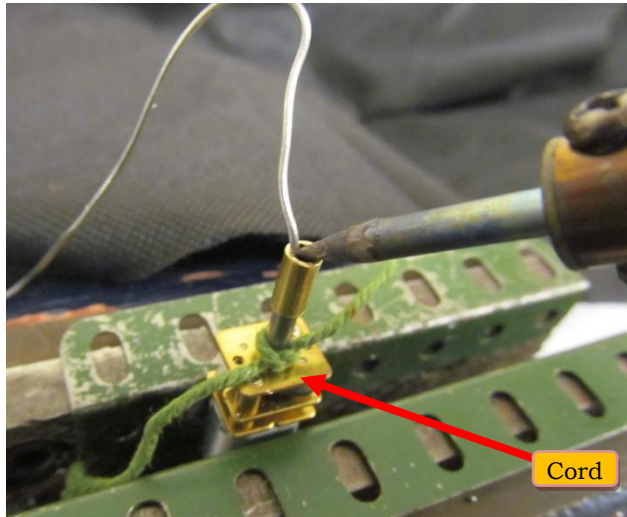

Cord

Tie the cord around the shaft to prevent the brass sleeve slipping down too far.



CLICK HERE >> <https://www.youtube.com/watch?v=Gsp5Bdbd09w>

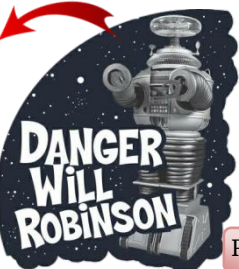

Can I fit the sleeve and solder the wires on in 2 minutes?



N20 Motor Mounting

So now you have some motors ready almost to go in your model(s) Before we do that, it makes sense to attach a pair of wires to each motor as it's a certainty you won't be able to fix them later once it's buried in the model.

The bush at the base of the shaft is 4mm which is perfect to locate the motor into a Meccano hole. The threaded holes for the mounting bolts are M1.6 which is very small but they can be sourced on eBay or if you have a collection of old DVD or VHS video players you can often find them inside.



What wire you use is not important as the current drawn is tiny. I would suggest that 0.5mm stranded is suitable and will be small enough to attach to the tiny terminals. I would advise using stranded wire as single core will be liable to break, after you have twisted and poked it through the various holes in the model whilst routing it. You should have a range of colours that can be twisted together in different combinations, so that you can identify which pair come from which motor. I usually twist them together using a battery drill and trap the wires in the drill chuck.

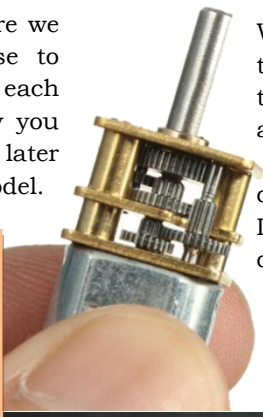

Use Part 45



Use plastic clips from eBay

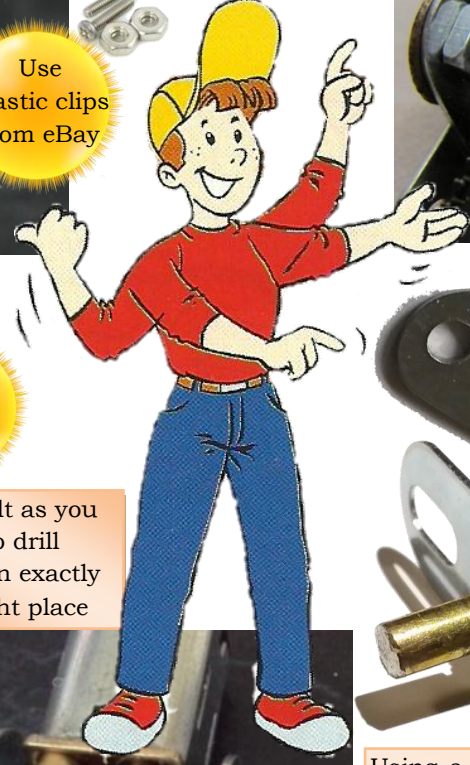
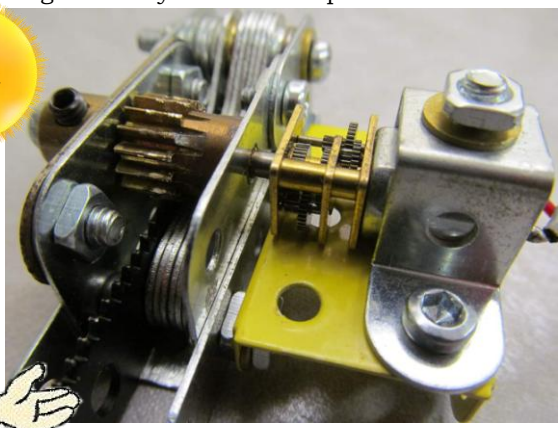

Use Part 48a

Difficult as you need to drill holes in exactly the right place

It's difficult to drill holes so close to the edge of a Fishplate so you can simply make notches on the sides with a hacksaw.

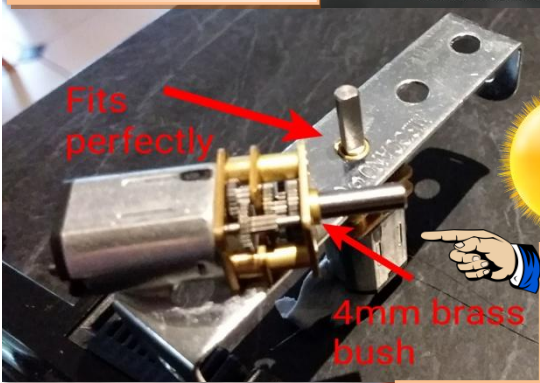

Fits perfectly

4mm brass bush

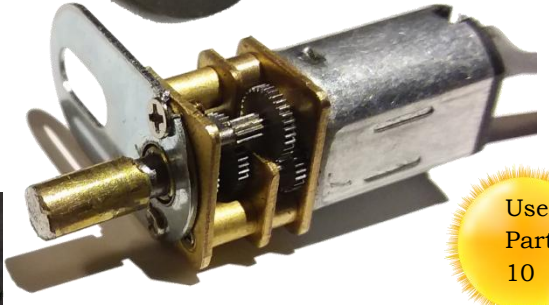

Use Part 10

Using a Part 11 Double Bracket is a very neat and compact way of mounting the N20 and there is just enough room to fit a nut but beware. You must use a locknut or washers to stop the bolt from protruding past the nut.



The motor is held in place by the Bush Wheel or Gear or Pinion and can't turn because of the folded sides of the part 212 Rod Strip connector.

Use Part 212

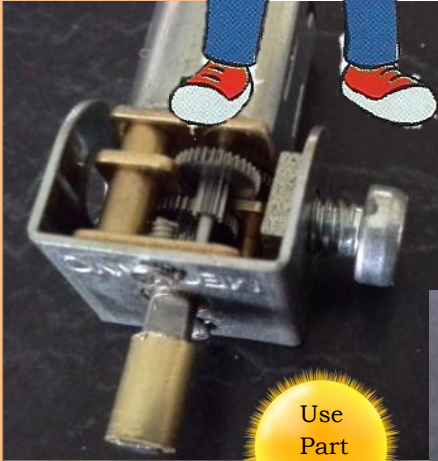

Use Part 11

N20 geared motors



4mm brass sleeves on 3mm shafts Mounted on fishplates with M1.6mm screws

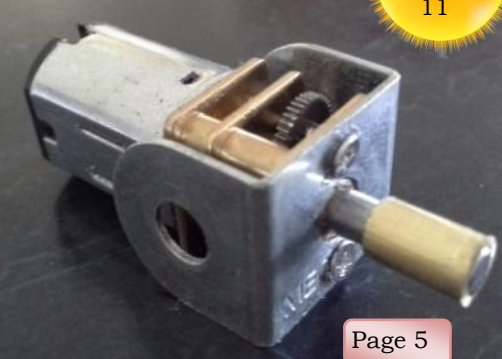
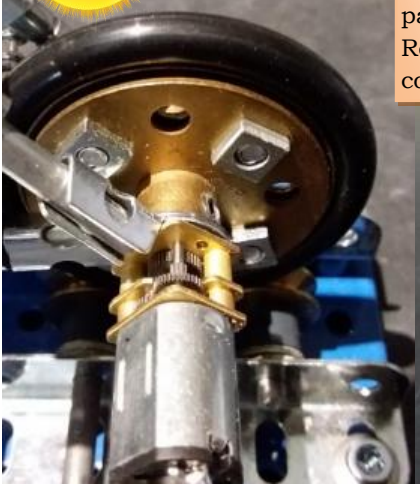

Matthew Auger from sunny Queensland Australia has a go at his own version of the popular Guilloché drawing machine

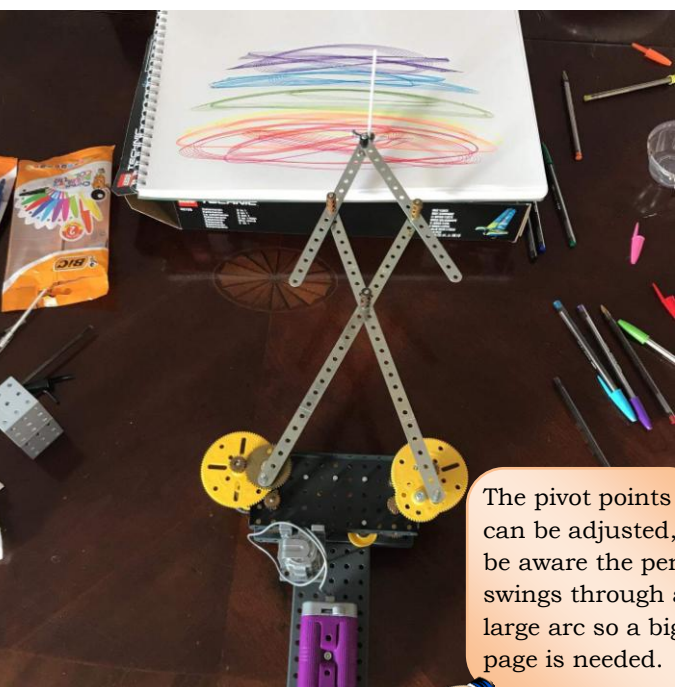

The pivot points can be adjusted, be aware the pen swings through a large arc so a big page is needed.

Working from home during this lockdown I was browsing Facebook when I saw Chris Clinckx from Belgium post a Meccanograph called a Guilloché drawing machine. A quick Google search revealed a few of these around and so I set about building my own version with a few differences.



Any combination of gears with one tooth difference can be used.



The main change has been to get rid of the 133t gear and worm reduction and replace them with a two-stage drive reduction to a central point where it splits off into chains of 3:1 reductions, this means the two rotors are in sync with each other apart from the final 57t and 56t planetary drives. The main frame is 2 x 5.5" x 2.5" Flanged Plates held together by 2.5" x 1.5" Flanged Plates spaced out by 1.5" Strips. A third Flanged Plate is used to mount the Battery Box and the Bolt used for mounting has a 1" Pulley and Tyre underneath to stabilise it.

See this version on YouTube by Jordi Vallés from Club Meccano de Catalunya, Barcelona

 <https://youtu.be/Csf-62DfY48>

Officeworks sell a pack of rainbow coloured Bic pens that are ideal for drawing machines.

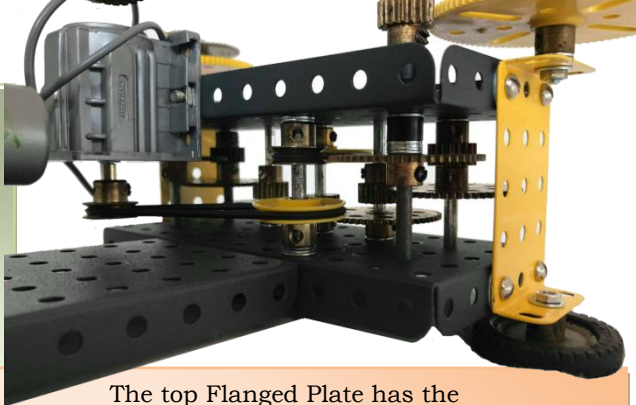
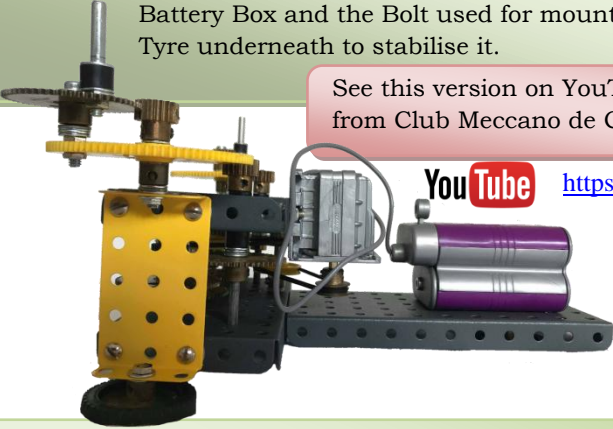

The top Flanged Plate has the motor bolted to it. The gear chain is as follows. 0.5" Pulley driving 1" Pulley, 0.5" Pulley driving centrally mounted 1.5" Pulley and 19t Pinion. Left and right of this Pinion are 57t/19t in 2" Rods with Collars underneath. These drive further to the left and right 2" Rods with 57t/19t with a Collar on top. These in turn drive 3" Rods mounted towards the back of the model with 57t Gear and Spacer under the top Flanged Plate and a 19t Pinion and two Spacers mounted above. These final Pinions drive the 95t Gears mounted freely on long Threaded Pins on the centre holes of the top flanges of the parts 54 each side. Above the 95t Gears are 19t Pinions fixed to the Threaded Pins spaced by a Washer.

See Matthew's Guilloché drawing machine here

 <https://youtu.be/phkwjIGGwCk>

For the right hand side there is a 3/4" Pivot Bolt mounted in an outer hole carrying a 57t Gear and a long Threaded Pin in one of its holes with a Washer and Spacer. On the left hand 95t Gear a 3/4" Pivot Bolt carrying a 56t Gear is mounted on a slotted hole, slightly in from the end so that it meshes well with the 19t Pinion. The 56t Gear carries a long Threaded Pin with Washer and Spacer. The Strips carrying the pen pivot on long Threaded Pins with Couplings above the Strips and spaced by Washers. The pen is held by a single arm Crank and Pivot Bolt to tighten against the Bic pen. The two holes of the Crank are bolted to one of the 7.5" strips by a Pivot Bolt with a Spacer the end of the other 7.5" strip - and a normal Nut and Bolt the other hole of the Crank.

Yet another Braider!

Around a decade ago I was very pleased indeed to have designed and built my first successful flat-braid braiding machine. I wanted something a little different from the usual circular Maypole braiding machine.

In flat-braid machines the braiding spools do not complete full circuits as in normal Maypole braiding but circulate back and forth between end carriers in their travels, passing each other in and out on the way. There are some other restraints too: the end carriers must contain odd numbers of forks and one more set of forks than do the intermediate carriers.

End carrier diameters larger than those of the intermediate carriers make for smooth meshing of the forks, and run more slowly than that of the intermediate carriers. This all makes for some straightforward, but nevertheless interesting design.

My first such machine was completed in August 2010 and it was exhibited at the CAM Expo in France in June 2011 and at SkegEx in July 2011. Now, after 10 years building more braiding machines, I thought I could repeat the flat-braid exercise, and do a little better.

by Graham Jost



Fig 2. 2020 Braiding Machine

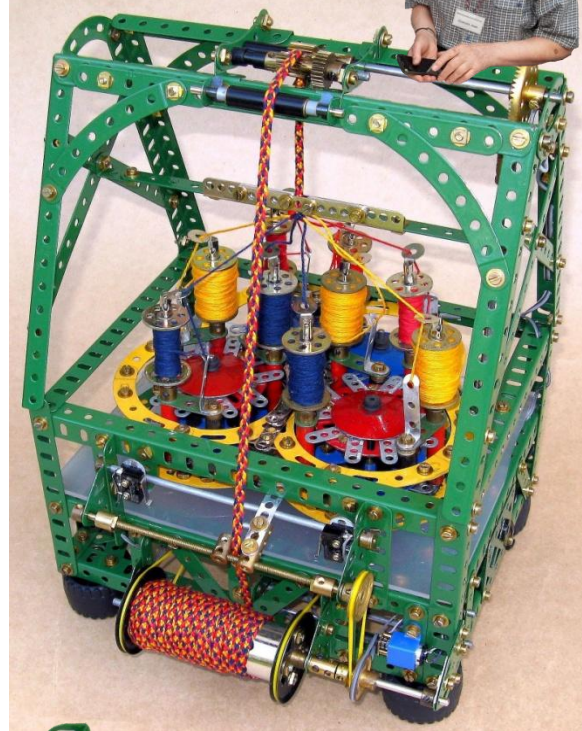

Fig 1. 2010 Braiding Machine

This machine is still extant. Its main footprint is 12 1/2" square x 16" high and it weighs 6.9 kg fully loaded. It braids seven threads of 4-ply cotton circulated by six carriers: four two-fork intermediate carriers and two three-fork end carriers. It was quite a package to take to Europe!

In designing the new machine, I decided to increase the number of forks throughout, thereby similarly increasing the number of threads being braided. By using Exacto 5-hole Faceplates for the end carriers, each equipped with 5 pairs of forks, and only two intermediate 2" Pulley carriers, each with 4 pairs of forks, I could increase the number of circulating spools of thread from 7 to 9, Fig 3. More intermediate carriers could be used, but with every such increase a like increase in spool changes per unit time must accrue – the line has to be drawn somewhere!

My braiding machines run more quietly if the axles of the spool assemblies are clothed in Meccano Plastic Axles. The Plastic Axles then bear on the guides rather than bare metal ones. The rims of each pair of carriers need to be spaced just a little over 3/8" apart to permit free passage of the spool assemblies between them and these are now non-standard. I spent some time in arriving at a layout fulfilling this requirement, Fig. 4 (there is no gearing between end carriers) where the gearing between carriers is already in place. Non-standard spacings mean that straightforward gearing between carriers is not possible either, so floating links are used instead. Fig. 5 shows the gear assembly before installation. The whole fits neatly into a 9 1/2" x 5 1/2" rectangular framework, this being usefully more compact than the 12 1/2" x 12 1/2" of the 2010 machine.

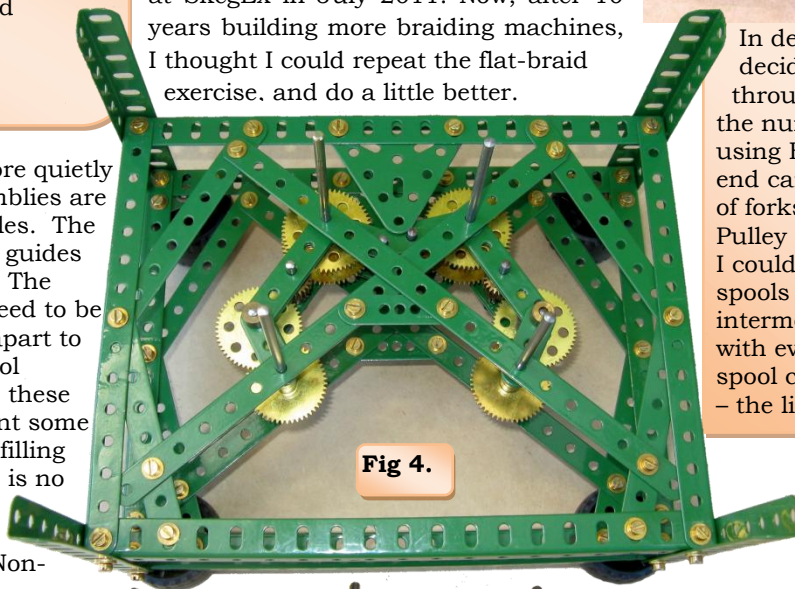

Fig 4.

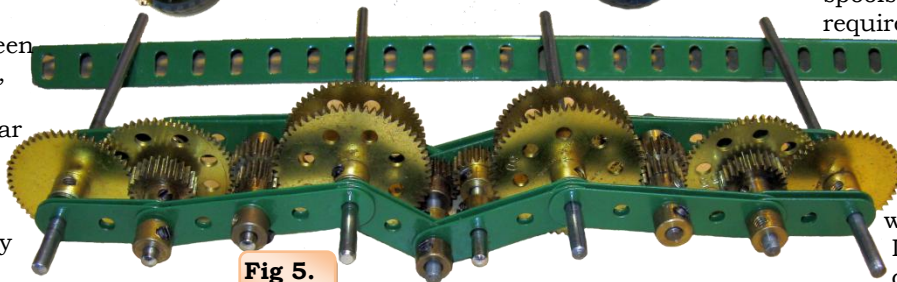

Fig 5.

In other respects, my usual braiding machine details are used throughout. Eccentric-driven wagglers switch the spools between carriers as required, and the completed braid is drawn at constant speed to be guided onto the take-up roller down in front. At 4.5 kg, this braider is usefully lighter in weight than its predecessor. I am very pleased with the quality of the braid being produced too, which is nice and tight, Figs 6&7.

More info on the NZM website



<http://www.nzmeccano.com/image-147774>

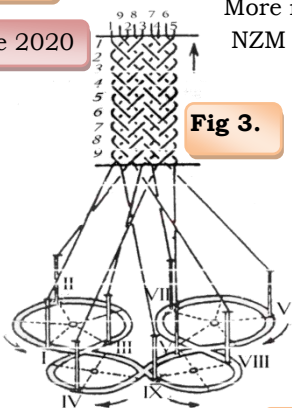

Fig 3.

See Sheffield Meccano Guild Journal No.138 for June 2020



Fig 6.

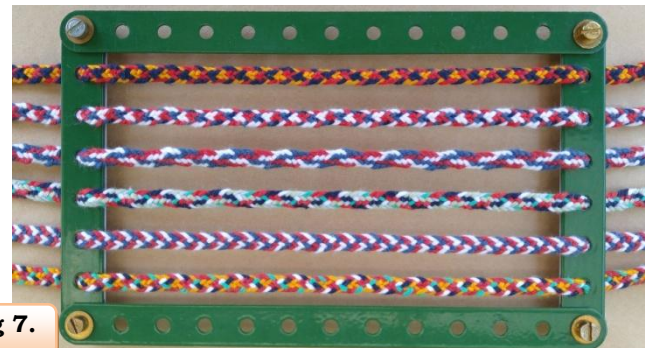
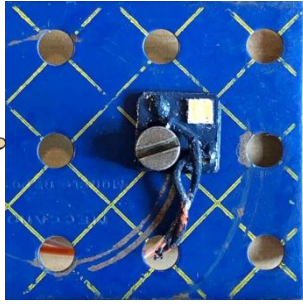

Fig 7.

How to repurpose LED lightbulbs

by Peter Sullivan - Switzerland



1. Prise off the metal screw base in a vice.



2. Carefully chip away the plastic PCB shroud with cutters. The shroud is also glued with silicon to the dome top.



3. With at least half of the shroud cut away, the LED driver Power Supply Unit can be removed. The board is connected by a small two pin connector to the LED PCB, and should disconnect easily. The PSU board was connected to the lamp base by a solid wire, and a 10 ohm surge limiting resistor.

Manufacturers claim 20,000 to 30,000 hours lifetime for your common Light Emitting Diode light bulb. In practice, you will find some of these energy efficient lamps become faulty much earlier on and on cracking open two faulty 200 lumens examples, (from a well know Swedish home furnishing store!) it was found that both had prematurely failed from one of their LED chips failing rather than the constant current power supply board in the base of the bulb. (Note: non-linear impedance LED bulb chips are usually driven at a constant current rather than a steady voltage.) As was the case for the two faulty bulbs, the LED chips are often wired in series, so if one of the chips burns out and goes open circuit, the whole LED chain is killed rendering the bulb completely useless. Can we recuperate something useful for the Meccano hobbyist? Yes indeed! The non-defective LED chips can be salvaged as neat and powerful tiny lighting units for models! Disassembly is not easy, but the following photos show how.



4. Cut away all the silicon compound from around the dome base and you can then remove the LED Printed Circuit Board and its metal support. The bulb is now completely disassembled. The part we're after, the LED PCB is circled in red in the photo below. It can be appreciated that the bulb components are not so eco-friendly to dispose of. Plastic, electronic components, metal and LED diodes with rare-earth elements etc!

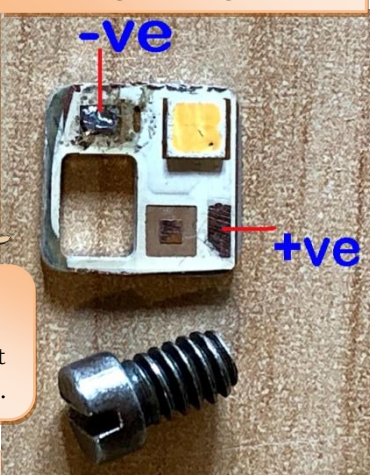
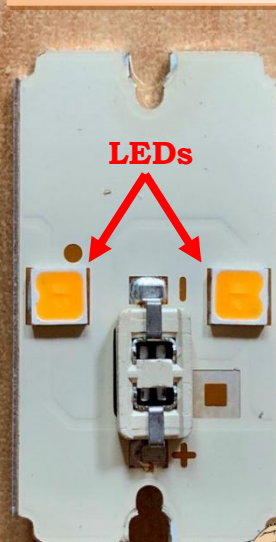

5. Identify which LED is open circuit by injecting a few mA from a low voltage source across each diode in turn. You might need to scratch away some of the protective paint to access the PCB tracks to do this if a mid-way test pad is not printed. A 5v supply in series with a 100-ohm resistor worked well to test the LED chips in this model.

6. Desolder the 2-pin connector. The rectangular hole can take a Meccano bolt to fasten the LED to a model.

Note for the technical minded: The surface mount LED chips used in this bulb are comprised internally of two tiny LEDs in series, so each need at least 4 volts before they will conduct when forward biased, so for the complete assembly 8 volts. Brighter bulbs on the market use more powerful LED chips with several LEDs internally in series so would require an even higher voltage before they start to conduct. A standard silicon rectifier diode you would find in a power supply has quite different characteristics and has a forward conduction voltage drop of about 0.7V. It can stand a very high reverse voltage, and is much more efficient at rectifying AC into DC.

7. Using a small hacksaw carefully cut away the portion of the PCB with the faulty diode to leave the functioning one on a square piece of PCB together with the fixing "hole". File the edges smooth. Although difficult to capture in a photo, below is an example of the illumination from this small Surface Mount Device LED running at 60mA forward current. Please pay attention to safety for your eyes if you experiment with high LED currents!

8. Power supply for the LED chip.

Using a 100-ohm current limiting resistor in series with the LED and a 12-volt power supply, gives extremely bright illumination, quite uncomfortable to look at directly!! With this arrangement, the LED chip is drawing about 60mA, so the limiting resistor needs to be correspondingly rated not to burn out if the LED is active for long durations. A 1-watt resistor or larger will be adequate. For lower levels of illumination just increase the value of the current limiting resistor – for example 220ohm.



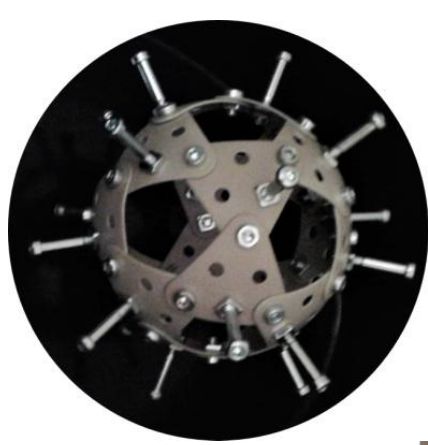

Michel Hotton
Canada



Georg Eiermann
Germany

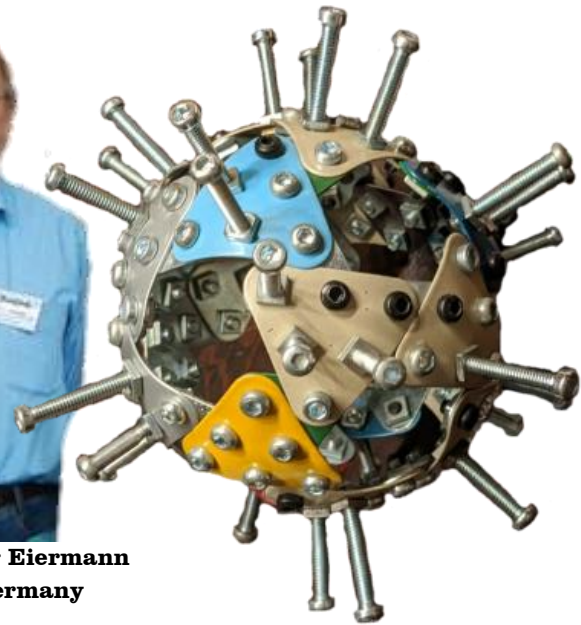

Thierry Monnier
France



Gabriel Fontana



Gabriel Fontana
Spain

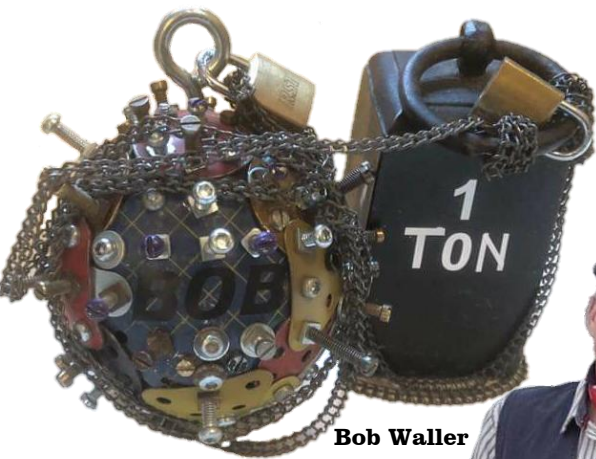

Bob Waller
UK



Thomas Rothenhausler
Switzerland

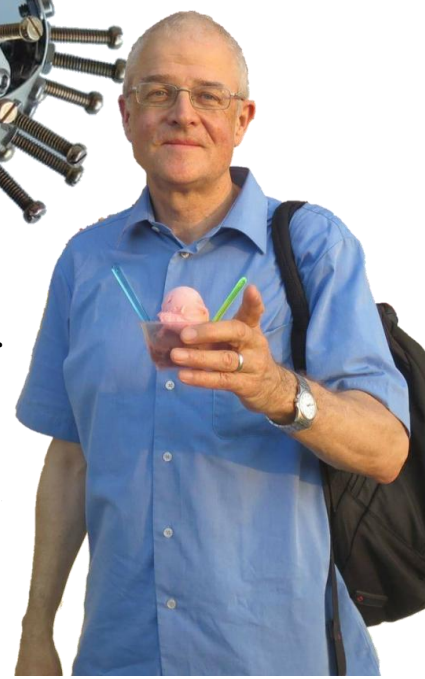

YouTube See Bob put paid to the virus here

<https://youtu.be/rNX9iqoGf0I>



Mars Rover Arcade Simulator

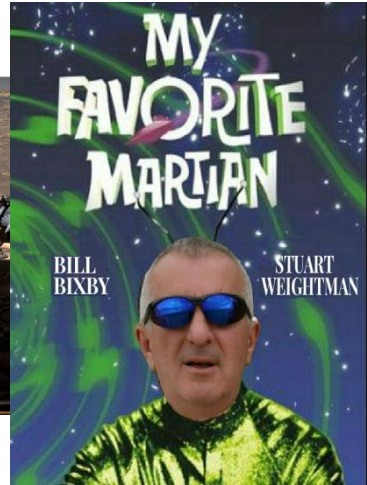

by Stuart Weightman

I have made several models and displayed them at Meccano exhibitions and found if the model's operation is more than a couple of minutes the audience seem to lose interest and their eyes seem to glaze over. LOL. (I started thinking of taking a defibrillator with me!) Of course this only applies to the general public as Meccano enthusiasts take a more detailed interest in the construction etc. I set out to make a model which had a fair bit of audience participation. The Iron Gauntlet got a great reception and people were queuing to use it in France.

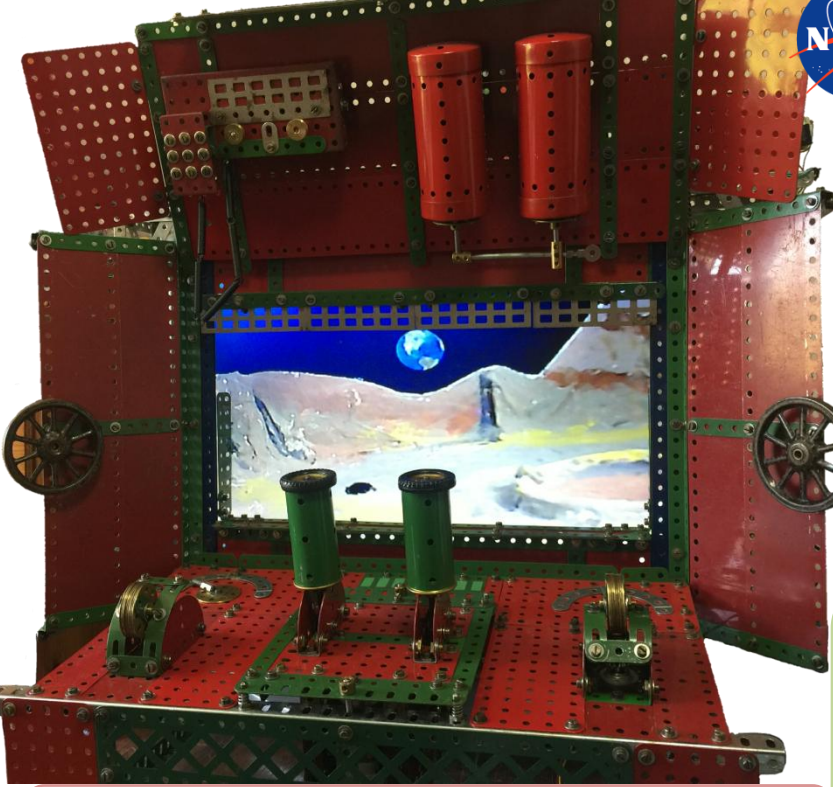

The Arcade view with joysticks in the centre. The brass Wheel Disk controls either side are Left: Spotlight and Right: Armour plated window screen control. There's a distant Earth in the background.

My initial idea was to have a mini camera suspended from a gantry X-Y plotter type control which moved the camera around a few cm above the arena. But I decided on an easier option which was to have the camera mounted on a vehicle. I wanted the smallest vehicle possible so no joke I must have had about 8 versions until I decided on the 4 x N20 motor version. I did intend to use a tracked vehicle and real sand in the arena but decided that sand may get in the gears and would end up everywhere indoors.

The Arcade module was built to simulate a person sitting in the driving seat of a Mars explorer hence the oxygen tanks, radio and submarine type door handles.

Horizontal N20 motors x 4

After many prototypes I've settled on this one.

I bought the TV second hand and specifically a 12V safe version. Having the TV hidden behind an armoured window would give an air of mystery and having it timed for 2 minutes would give the user a nudge that it was over. I bought the camera on eBay. It was rated at 5-12V but I found any more than 6v would overheat it.

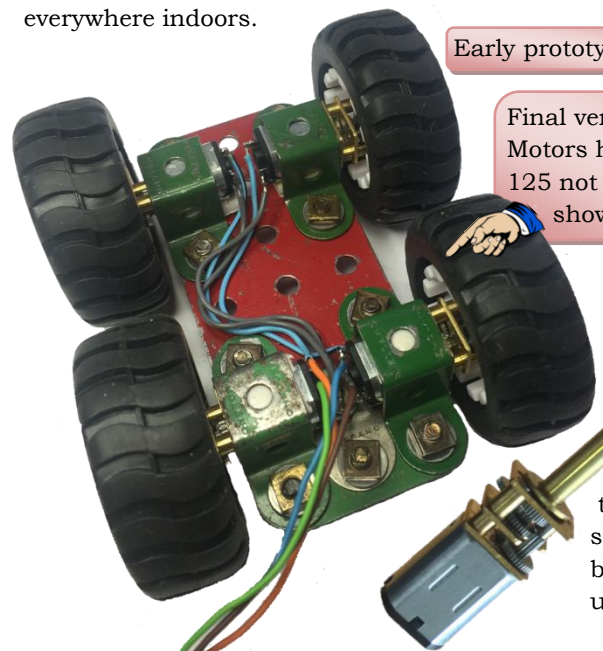

Early prototype No 1

Final version. 4 x N20 Motors held in with part 125 not 45 as shown.

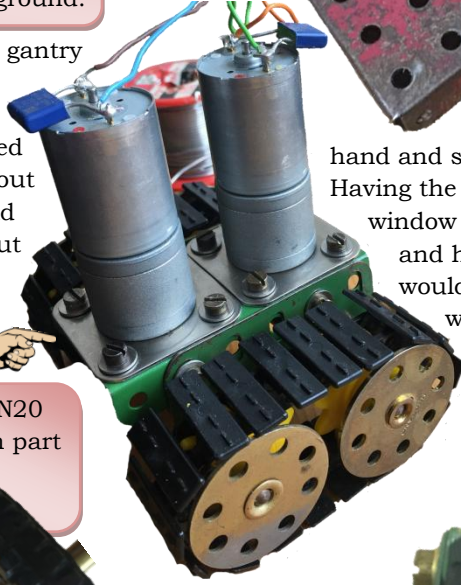

The vehicle speed is via a hidden speed controller as I did intend to have an accelerator available to the user but found a steady pre-adjusted speed was sufficient and less likely to get broken. I can easily reach underneath and adjust this.

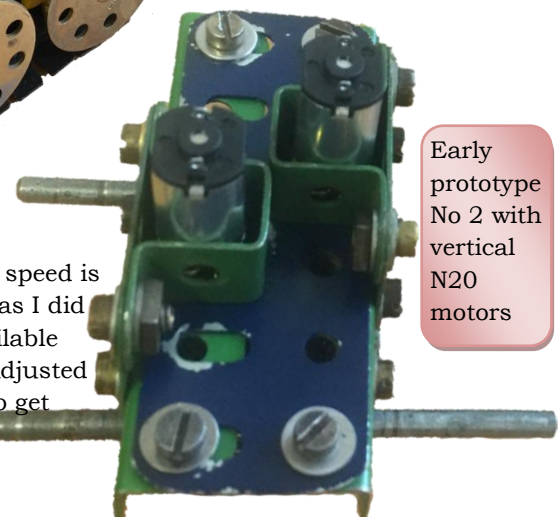

Early prototype No 2 with vertical N20 motors

Kidproof!



Joysticks

The vehicle control consists of 4 limit switches operated by two axes which have stops to prevent bending the limits levers and has spring return to centre. Giving forward, backward and spin control. The speed has been previously set. For the vibration feedback effect, the whole joystick assembly is mounted on springs with guide posts. Each joystick has its own motor with eccentrically fitted discs for vibration.

I tried to make the Joysticks as mechanically robust as possible.

The motors with the offset Bush Wheels are wired in parallel with the N20 motors on the Mars rover vehicle in the adjacent landscape module.

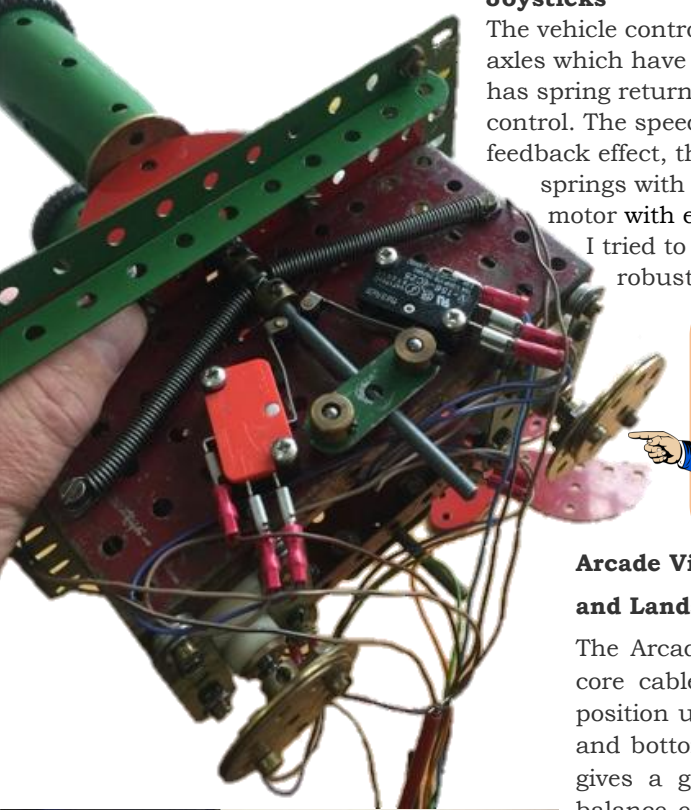

Arcade Viewer with Joysticks and Landscape modules.

The Arcade module and the Mars landscape module are connected via an eight core cable and easily separated for transportation. The 12v TV was bolted in position using its stand and enveloped in Meccano. The armoured windshield top and bottom halves are operated by a panel switch and stop automatically which gives a good effect. Both halves are hanging on chain/sprocket and counter balance each other's weight whilst being moved by a worm drive assembly. The camera was connected via a screened cable and, with a lot of trial and error, fixed in the best viewing position on the vehicle.

Although it's been a long time, I still remembered the Papier-mâché recipe and enjoyed making the Mars landscape. Once dry I tried within the limited enclosed space to make it as visually realistic as possible by painting the rocks and spacing off planets on a black background, I also added a powerful sun effect lamp. The whole arena does have a lid so the use of the switch operated searchlight is useful when behind the tall rocks. Naturally its disappointing not being able to exhibit at French CAM and Skegness this year but gives me time to add a couple of refinements such as the timer for the armoured screen to close automatically and a Martian or two to appear in the landscape when you least expect it. Whilst I'm in lockdown another 3 models are in progress. – Stuart Weightman

See Stuart's YouTube video here [CLICK HERE >> https://youtu.be/hWAl6A0qh9M](https://youtu.be/hWAl6A0qh9M)

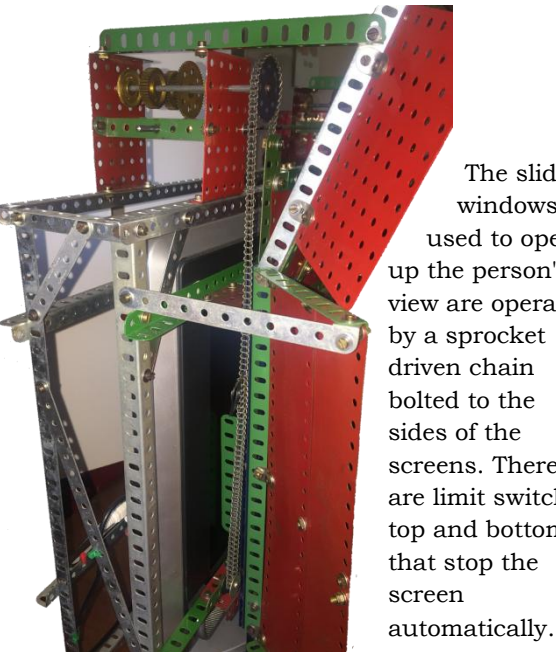
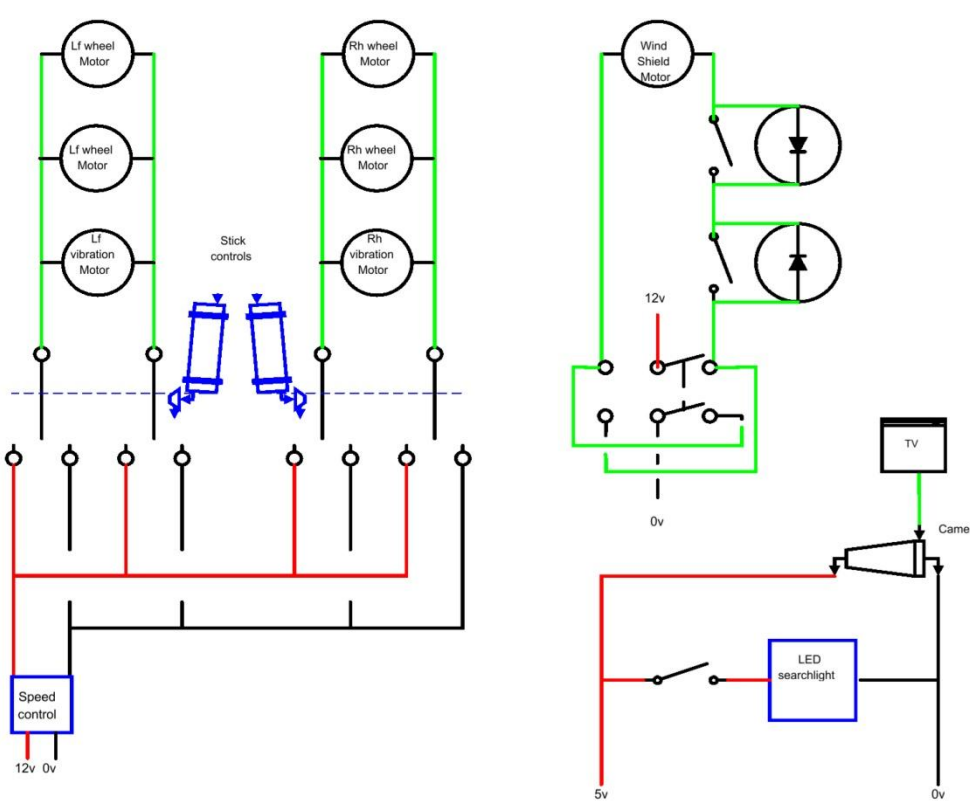
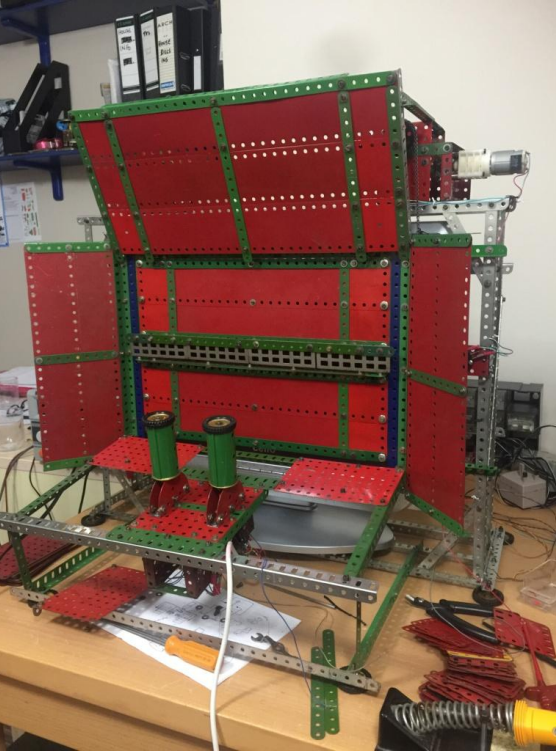

The sliding windows used to open up the person's view are operated by a sprocket driven chain bolted to the sides of the screens. There are limit switches top and bottom that stop the screen automatically.

Show us your Meccano room

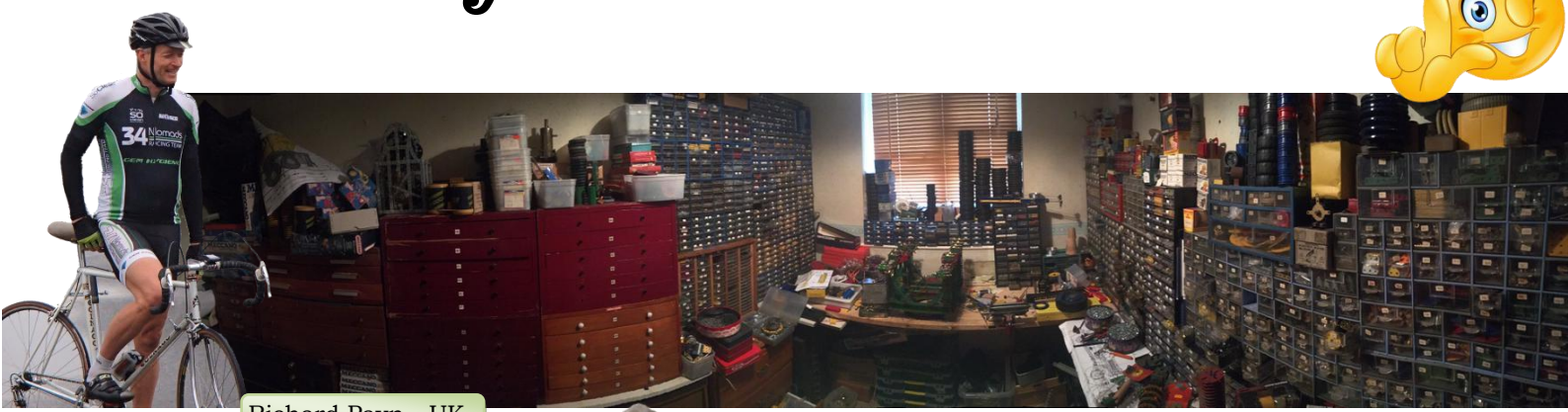

Richard Payn - UK



Andrey Kovynev - Russia

Alan Espen - UK



Philip Webb - UK

Les Pook - UK



Daryl Anderson - NZ

Meccano Wordsearch

C U G J C G N N Q W X H Q J J
 N J D N C O R D S U Z W Z S B
 J O P M I X N A X A L H E D Q
 I C I N R L I T E G N I H J N
 X G I N T O P U R G Z O R J N
 T P Q E N R W U K A D A E W Q
 P C W I E U B M O Q T T N S L
 O S I D C S R Y O C A E N W Q
 S P R O C K E T H L D C A G L
 N I Z R E L L E P O R P P K Y
 G I E U L Q T H N B I Y S L M
 U W C U W A S H E R F F M B U
 W T P B Q I A V T O T B R A F
 C M V H F T E S J E V T T A E
 E H J U U L L B I O D C D O A

Your mission, should you choose to accept it, is to find all the Meccano parts WITHOUT looking at the part names bottom left OR the part pictures bottom right. The part numbers below are to be used as clues only, not as literal translations. ie 52 might be just 'plate' not Flanged Plate.

Part Numbers

Level 3 Expert

30	8	148
28	69a	17
40	114	34
63	57	95
36c	147a	5
130	25	126
10	41	38
31	22	32

Level 1 Easy

Only for rank amateurs

Fold here

BEVEL
 CONTRATE
 CORD
 COUPLING
 DRIFT
 ECCENTRIC
 FISHPLATE
 GEAR
 GIRDER
 GRUBSCREW
 HINGE
 HOOK
 PAWL
 PINION
 PROPELLER
 PULLEY
 RATCHET
 ROD
 SPANNER
 SPROCKET
 STRIP
 TRUNNION
 WASHER
 WORM



Level 2 Medium

This Month's Meccanoboy

Keith Campbell Northern Ireland

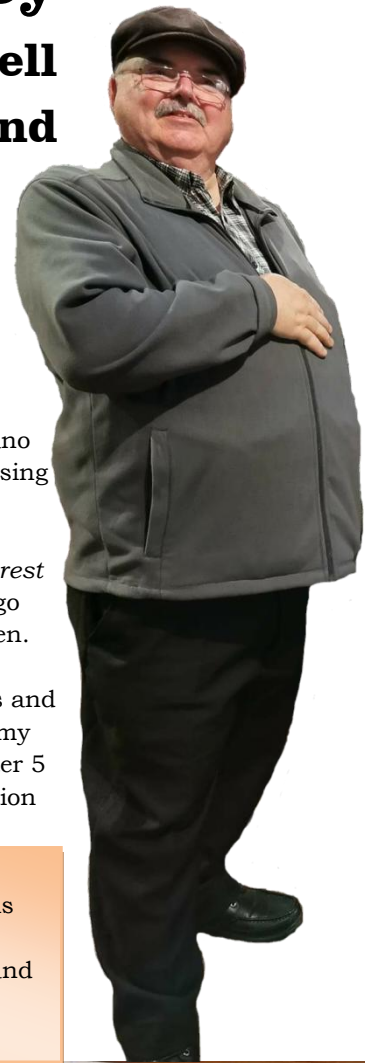

When and where were you born?

I was born in 1958 in a small village rear Antrim, Northern Ireland called Dundrod, about 10 miles from Belfast. Nobody would have heard of Dundrod if not for the famous motor bike races 'Ulster Grand Prix' held there every August.

Did you have Meccano as a kid?

I started messing around with my older brother's Meccano when I was about 4 and got my first Meccano set for Christmas when I was about 5. I've been messing around with it on and off from then to this very day.

I remember my first model was a three wheel car.

Have your kids and grandkids ever shown much interest in building Meccano? I married Margaret 37 years ago and we have 6 kids between us and 22 grand children.

I kid you not, not one has shown any interest in building Meccano. You would think out of 6 kids and 22 grand children there would be one! I bought my grandson a Meccano set for his birthday but after 5 minutes he realised he couldn't make a PlayStation with it so he threw it aside!

What was your favourite model?

My favourite model was based on an MW Models plan called Rotating Big Wheel. I improved the model over a couple of years until it was huge and I could no longer get it in the back of the car.

See video below.



What did you do for a living? Have you retired yet or is it a semi-retirement?

Started work at 16 as an apprentice fitter in the old linen mills now long gone. Went on to be the plant engineer of Daewoo Electronics UK here in their Northern Ireland plant, then for 15 years before I retired I worked for a well known bus manufacturing company called Wrightbus. After a few months of retirement I got bored, so for something to do and earn a few bucks, I put myself through the security exam and got my security licence. That was 3 years ago and I have been in security from then until now.

What are your favourite things these days?

I have a number of other interests. My sister calls me a man of many hobbies. They include building model radio controlled boats, collecting and operating live steam models and collecting vintage cameras (I have around 300). I have been a keen photographer from about 14 years old so I keep myself busy.

YouTube <https://youtu.be/f3i5jxCgTZ4>



Are you in any Meccano Clubs?

I'm currently the Chairman of the Northern Ireland Meccano Club. I was the secretary of the Antrim Camera Club. I also belong to the Seahorse Model Boat Club, and am a member of the Apprentice Boys of Derry (Antrim Murray Club).



CLICK HERE >>

<http://apprenticeboysofderry.org/home/4590560770>

The Troubles

I see photos of you in the army. What was that all about?

Growing up in Northern Ireland in the 1960s wasn't easy, there wasn't much money around, the country still hadn't fully recovered from the war. However they were happy times and innocent times for a child growing up in the country. That was all to change. I can remember the news reader interrupting the normal programs on the TV and pictures of burning buildings, rows of houses in Belfast ablaze with people running screaming. It was 1968 and the start of what became known as "The Troubles" or The Northern Ireland Conflict 1968-1998. 30 years of hell, murder and destruction. Every day there were people being shot and blown up by car bombs. Sometimes it became personal as family members and friends were killed. Eventually I was old enough and I joined the fight on the right side of the law. I became a part-time member of a regiment of the British army called the Ulster Defence Regiment or UDR. Later the entire regiment was awarded the Conspicuous Gallantry Cross and the regiment became UDRCGC (Google it for more info). I lost a few comrades along the way. The Troubles officially ended in 1998 with the signing of the Good Friday agreement, however there is still a hard line element that carry on with their killing to this day although nowhere near as bad as it was.

Keith on his 50th birthday when he was a combat photographer for the Wartime Living History Association.

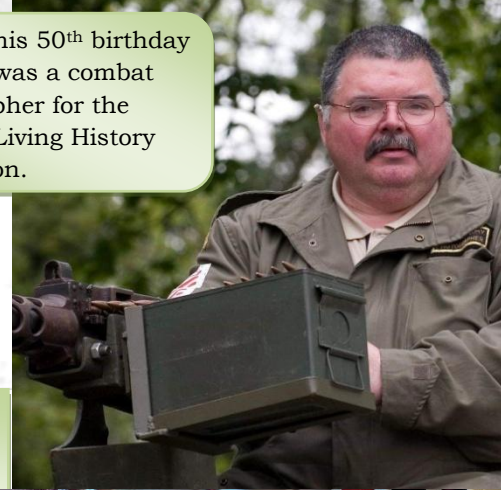

How much Meccano do you have? I can only use so much meccano so I've been putting about three quarters of my collection on eBay (keeping the best for myself of course) but I have discovered that the value of Meccano has fallen over the years and is now only worth about half what it was 6 or 8 years ago.



I have a well equipped workshop and make and modify some of my own Meccano parts. I have no problem in cutting, bending or folding Meccano parts. I'll do whatever it takes to get the model done so I'm definitely not what you'd call a 'purist'. My lathe is another valuable asset in my workshop and I use it to make many parts including collars from the buckets of unused part 22 pulleys that every Meccanoboy has.

I once saw a photo of you with a van overloaded with more Meccano than the Binns Rd storeroom. Where did you get all that from?

I have bought out two Meccano men. One a few years back when the guy was downsizing from a house to a small flat and no longer had the room for it, and about a year ago my good friend and NIMC member Bill Morrison sold me his large collection as ill health meant he could no longer use it. Sadly Bill passed away a few weeks back.

Psst. Wanna buy some Meccano?
It fell off the back of a truck!



What are your views on the direction Spin Master are taking with Meccano?

I suppose they have to move with the times and plastic is the new steel LOL. I have bought lots of their new kits and found them wanting. They need decent instructions to start with. I have found little use for the new parts in my own models. I have displayed at lots of shows over the years and the most asked question I get is "do they still make that Meccano?" I was asked so many times at one show that I wrote out a sign and put it on the front of the display. **YES THEY STILL MAKE MECCANO!**





A few of my favourite things.

We are John & Johnny. A father and son team who like Meccano. We're nothing to do with Spin Master who own the brand. Contact us at MeccanoNews@gmail.com
Follow Johnny Meccano



New Zealand

<http://www.nzmeccano.com>

<http://www.nzfmm.co.nz>

<https://www.facebook.com/MWT-Meccano-Club-1476153515979522/>

Australia

<http://www.mmci.com.au>

<http://www.sydneymeccanomodellers.org.au>

<http://www.webjournalist.com.au/maylands/index.html>

South Africa

<https://www.facebook.com/Meccano-Club-of-South-Africa-464753870326296>

USA and Canada

https://www.spinmaster.com/brand.php?brand=cat_meccano

<https://www.usmeccano.com>

<http://www.meccano.com>

<http://www.cmamas.ca>

<http://www.bcmeccanomodellers.com/meccano-in-canada.html>

<http://www.meccanoquebec.org/index2ang.html>

France

<http://www.meccanogilde.nl>

<http://meccano.free-bb.fr/>

UK

<http://www.internationalmeccanomen.org.uk>

<https://londonmeccanoclub.org.uk>

<https://tims.org.uk>

<http://hsme.org.uk>

<https://nelmc.org.uk>

<https://runnymedemeccanoguild.org.uk>

<https://www.selmec.org.uk>

<http://www.hsomerville.com/wlms>

<http://www.midlandsmeccanoguild.com>

<https://southwestmeccano.org.uk>

<http://www.northwestmeccano.co.uk>

<https://www.meccanoscotland.org.uk>

<http://www.corlustmeccanoclub.co.uk>

<https://nmmg.org.uk>

Personal pages

<https://www.alansmeccano.org>

<http://www.users.zetnet.co.uk/dms/meccano>

<http://www.dalefield.com/meccano/index.html>

<http://www.meccano.us>

<https://www.meccanoindex.co.uk>

<http://www.meccanokinematics.net>

Other Countries

<http://club-amis-meccano.net/>

Meccano suppliers

<http://www.meccanohobby.co.uk>

<http://meccanomaniac.co.uk/catalog>

<https://www.meccanospares.com>

<https://ralphsshop.com>

<http://www.hsomerville.com/mwmailorder>

<http://www.metalconstructiontoys.com>

<http://www.meerlu.com.au/>

<https://tinyurl.com/AshokBanerjee>

Like him or lump him, Mike Dennis is one of the most colourful characters in the Meccano scene.

See his gallery of tips, tricks and mutilation techniques in the NZM Gallery.



<http://www.nzmeccano.com/image-30750>

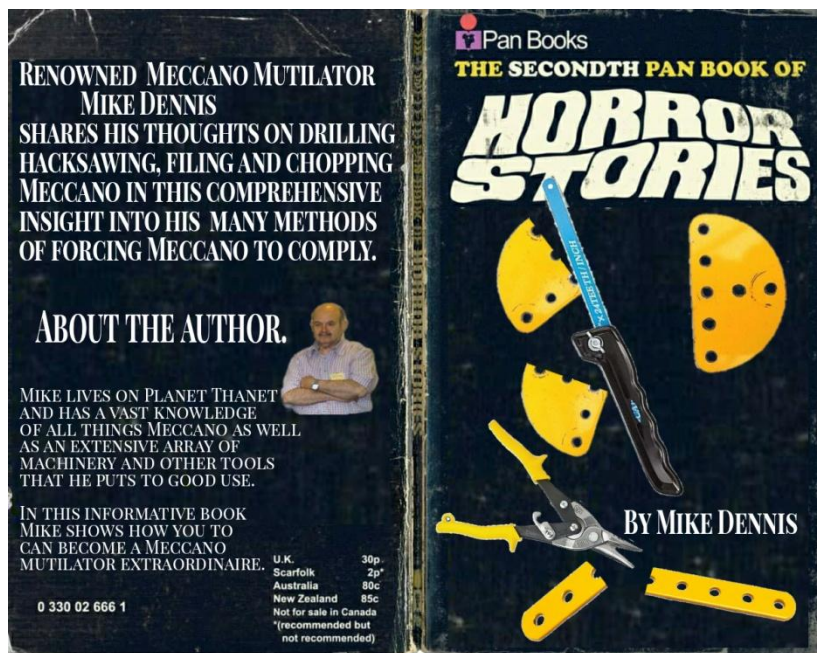

The only way to have a Sunday afternoon "quickie" with 8-year-old Johnny in the apartment was to send him out on the balcony with a

Popsicle and tell him to report on all the neighborhood activities.

"There's a car being towed from the parking lot," Johnny shouted as his parents put their plan into action.

"An ambulance just drove by!"

"Looks like the Andersons have company!" Johnny called out.

"Matt's riding a new bike!"

"Looks like the Sanders are moving!"

"Jason is on his skate board!"

After a while Johnny announced... "The Coopers are having sex."

Startled, his mother and dad shot up in bed.

Dad cautiously called out... "How do you know they're having sex?"

Johnny replied "Jimmy Cooper is standing on his balcony with a Popsicle."

This guy goes into the doctor's surgery and exclaims, "Doctor, Doctor, you've got to help me! I keep thinking... I'm a pair of curtains! The doctor replied, "Pull yourself together, man!"

RiotMachineMark5

If I had 50 cents for every math test I've ever failed, I'd have \$5.80.

Wife asks her Meccanoboy husband, "Could you please go shopping for me and buy one carton of milk, and if they have eggs, get 6".

A short time later the Meccanoboy comes back with 6 cartons of milk and his wife asks, "Why did you buy 6 cartons of milk?"

He replied, "They had eggs."

Paul got fired from his job.
Now he's a 147c.
DBDYNUT



Keep sending them in.
MeccanoNews@gmail.com