



BOOK OF MODELS  
VORLESERLESEBÜCHER  
LIBRO DE MODELOS  
LIBRO DE MODELOS  
LIBRO DE MODELOS  
LIBRO DE MODELOS  
LIBRO DE MODELOS

9

October 2023

## In this issue

Buy me a coffee

<https://ko-fi.com/johnnysmeccanomagazine>

This is entirely up to you but if you think this magazine was worth the price of a cup of coffee and you would like to contribute, click on the yellow 'Buy me a coffee' button above and it will take you to the website that gives you options for a safe, easy PayPal payment. Or just bypass the middleman and PayPal me directly.

<https://www.paypal.com/paypalme/JohnnyMeccano>

Build this

and this!

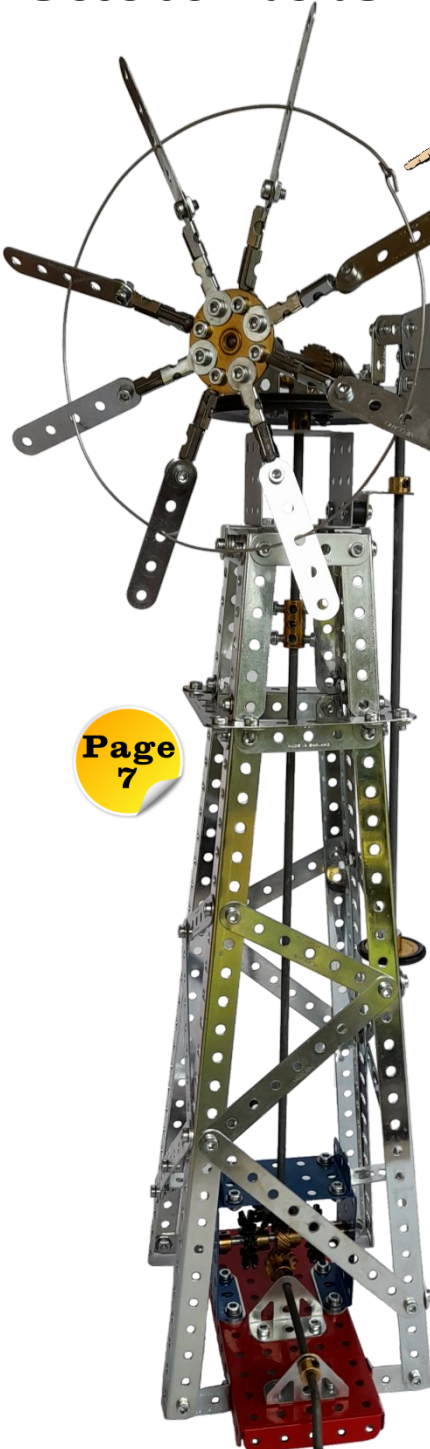

Page 7

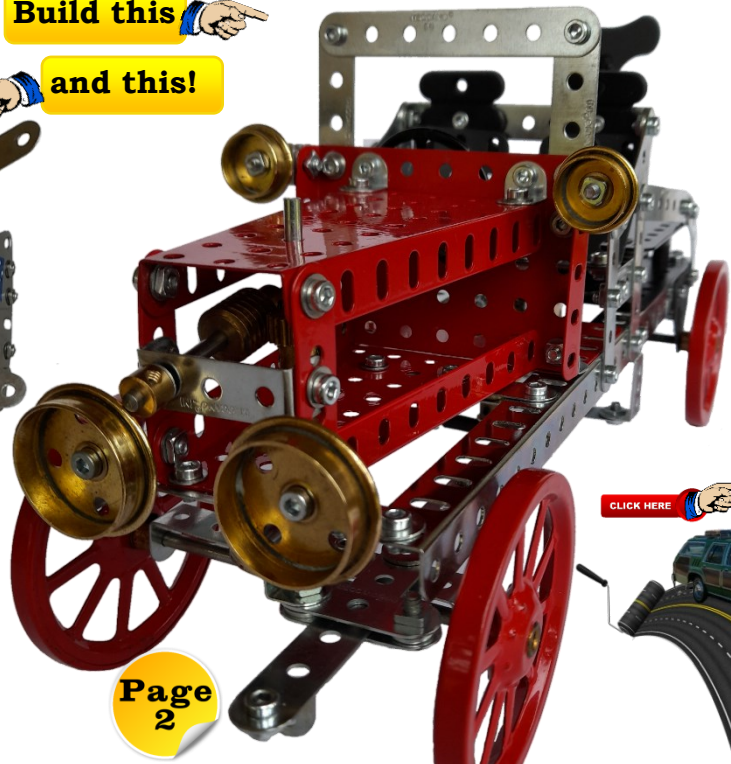

Page 2

CLICK HERE



Page 10

On The Road  
Model Engineers Expo



From this

**NEW!** My 2 Bob's Worth

Page 11

Page 5

to this!



This month's Meccanoboy is Georg Eiermann

Page 13



Page 1

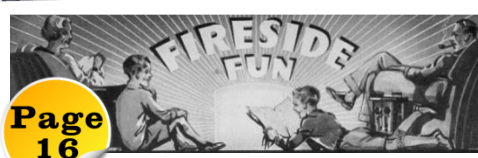

Page 16

GOOD IDEAS DEPT

Page 12

Page 6

Silver Surfer - Santiago Plicio



# Auto-Reverse Automobile



<https://youtu.be/44b8xnZSGYM>

Part No.	Description	Qty
1a	Strip 9½"	1
2a	Strip 4½"	2
3	Strip 3½"	6
5	Strip 2½"	3
6	Strip 2"	1
6a	Strip 1½"	7
8	Angle Girder 12½"	2
10	Fishplate	3
12	Angle Bracket	6
12a	Angle Bracket 1" x 1"	1
12b	Angle Bracket 1" x ½"	1
14a	Rod 5½"	1
15a	Rod 4½"	2
16	Rod 3½"	2
18a	Rod 1½"	1
19a	Spoked Wheel	4
20	Flanged Wheel 1½"	2
20b	Flanged Wheel ¾"	2
24	Bushwheel	1
26	Pinion 19t	3
28	Contrate 50t	3
32	Worm	1
38a	Plastic Spacer	2
43	Tension Spring	1
48	DAS 1½" x ½"	1
48b	DAS 3½" x ½"	3
48e	DAS 1" x ½"	3
51h	Obtuse Flanged Plate	2
53	Flanged Plate 3½" x 2½"	1
54	Sector Plate	2
55a	Slotted Strip 2"	1
59	Collar	5
62	Crank	1
90	Curved Strip 2½"	5
115	Threaded Pin	1
126a	Flat Trunnion	2
177a	Flexible Seat	2
185	Steering Wheel	1
190a	Flexible Plate 3½" x 2½"	1
518	Bushwheel 1"	1
	No. 1 Clockwork Motor	1

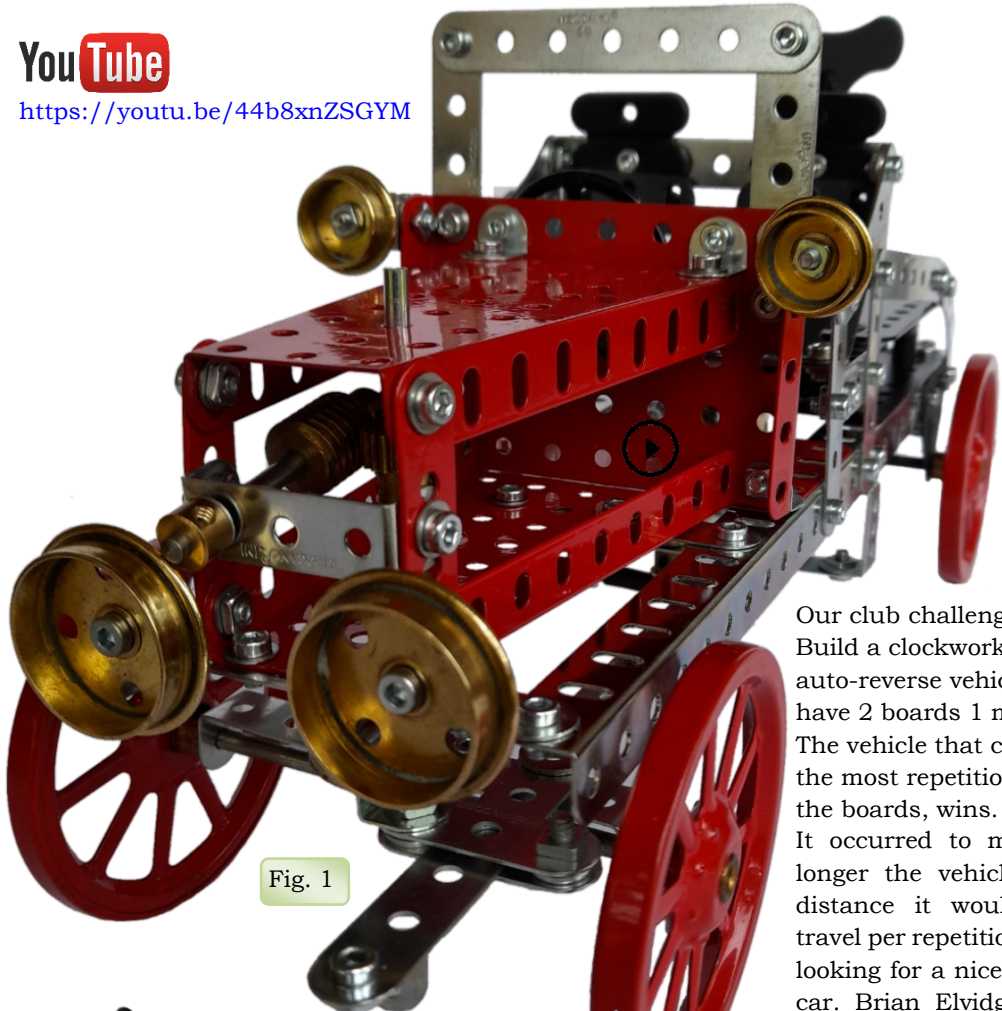

Fig. 1

Our club challenge was: Build a clockwork powered auto-reverse vehicle. We will have 2 boards 1 metre apart. The vehicle that completes the most repetitions between the boards, wins.

It occurred to me that the longer the vehicle, the less distance it would need to travel per repetition, so I went looking for a nice long model car. Brian Elvidge from the South East London Meccano Club had built a great looking car based on the Model No. 519 Motor Car in the 1927 Meccano manual.

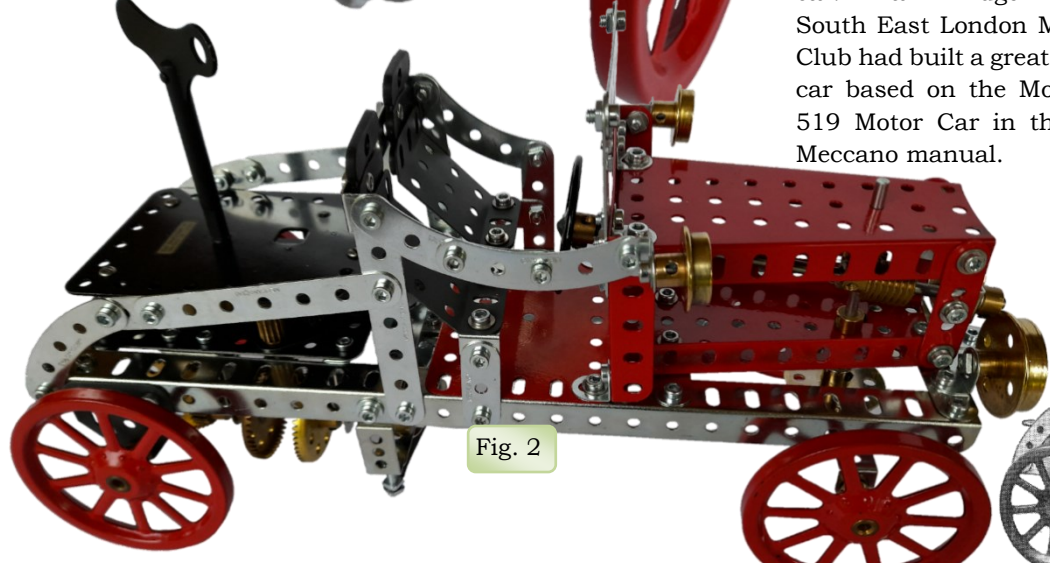
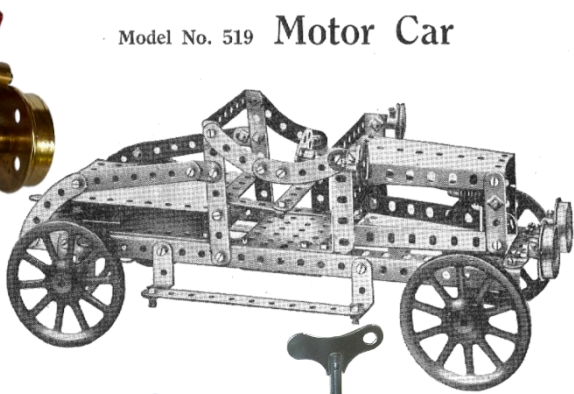

Fig. 2



Model No. 519 Motor Car

Building the Automobile is straightforward, and I used Brian's photo as my guide, but I left the running boards off to save weight.

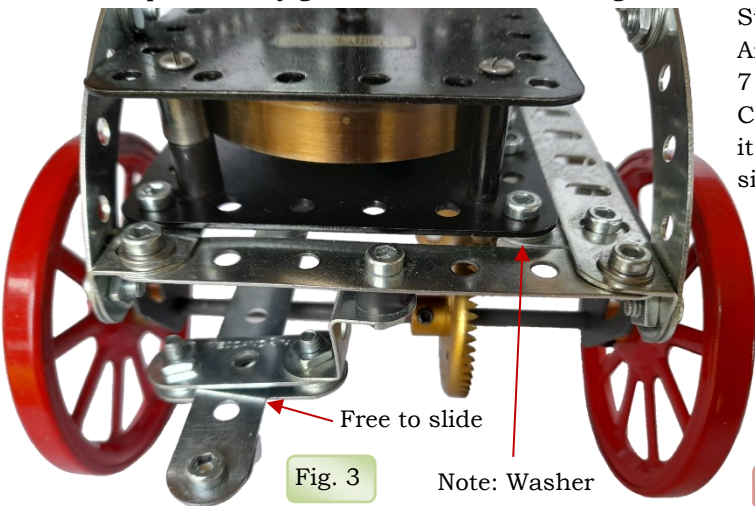
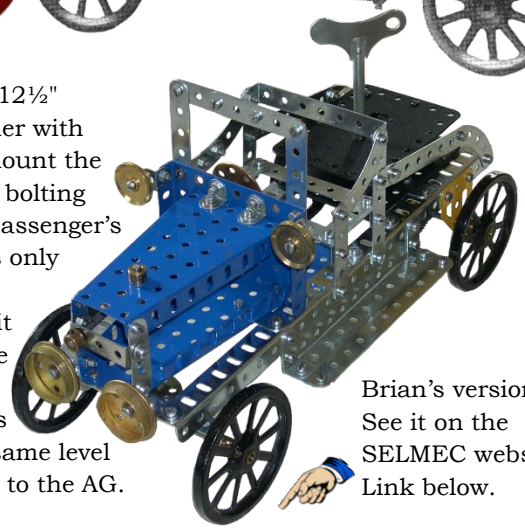

Fig. 3

Note: Washer

Free to slide

Start by bolting the 12½" Angle Girders together with 7 hole Strips then mount the Clockwork motor by bolting it to the AG on the passenger's side. As the motor is only 6 holes wide, use Fishplates to bolt it to the driver's side AG making sure the Washer brings the motor to the same level as if it were bolted to the AG.



Brian's version. See it on the SELMEC website. Link below.

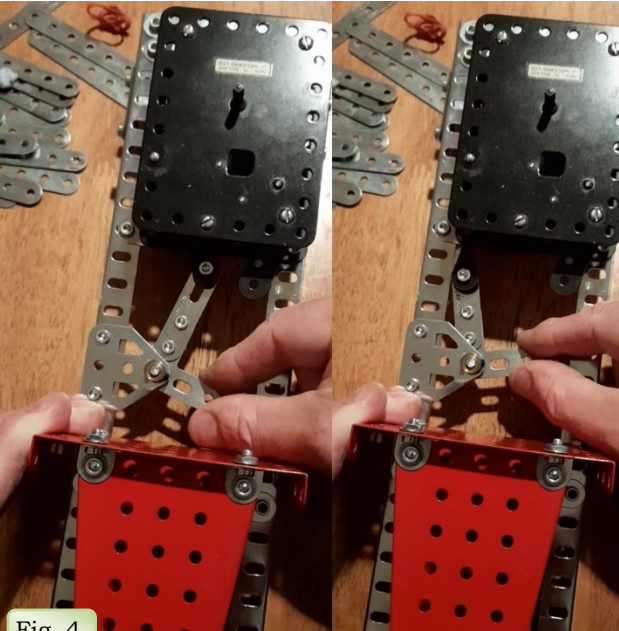

After building the automobile I experimented with a few ideas to get it to reverse automatically when it hit the blocks of wood spaced 1m apart. Attempt number 1 was to use the motor's own reversing lever, Fig. 4, and although that worked, it sometimes jammed, and it needed the automobile to hit the wood at full speed. As it got slower, the reversing mechanism started to fail. So, I moved on to attempt number 2 which was to use Pinions that move between directly driving the wheels for forward and then driving the wheels via another pinion for reverse. Fig. 5.

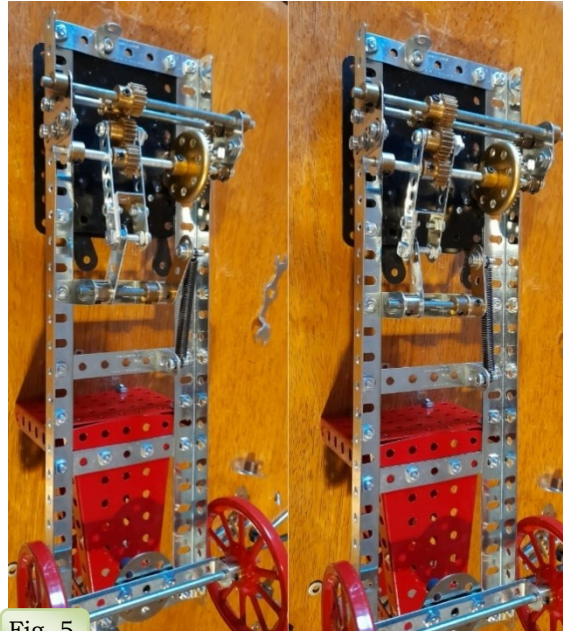

Fig. 4  
 YouTube <https://youtube.com/shorts/EHYS5-nR3H8>

Fig. 5  
 YouTube <https://youtu.be/JnpX-sD59Pk>

You can see in the video that it was working well without any load but when the wheels were fitted and a test run on kitchen bench was tried, it kept jumping gears under load. I tried higher tensions on the spring to try and keep the pinions engaged but that made it too hard to change gears so attempt number 2 was abandoned.

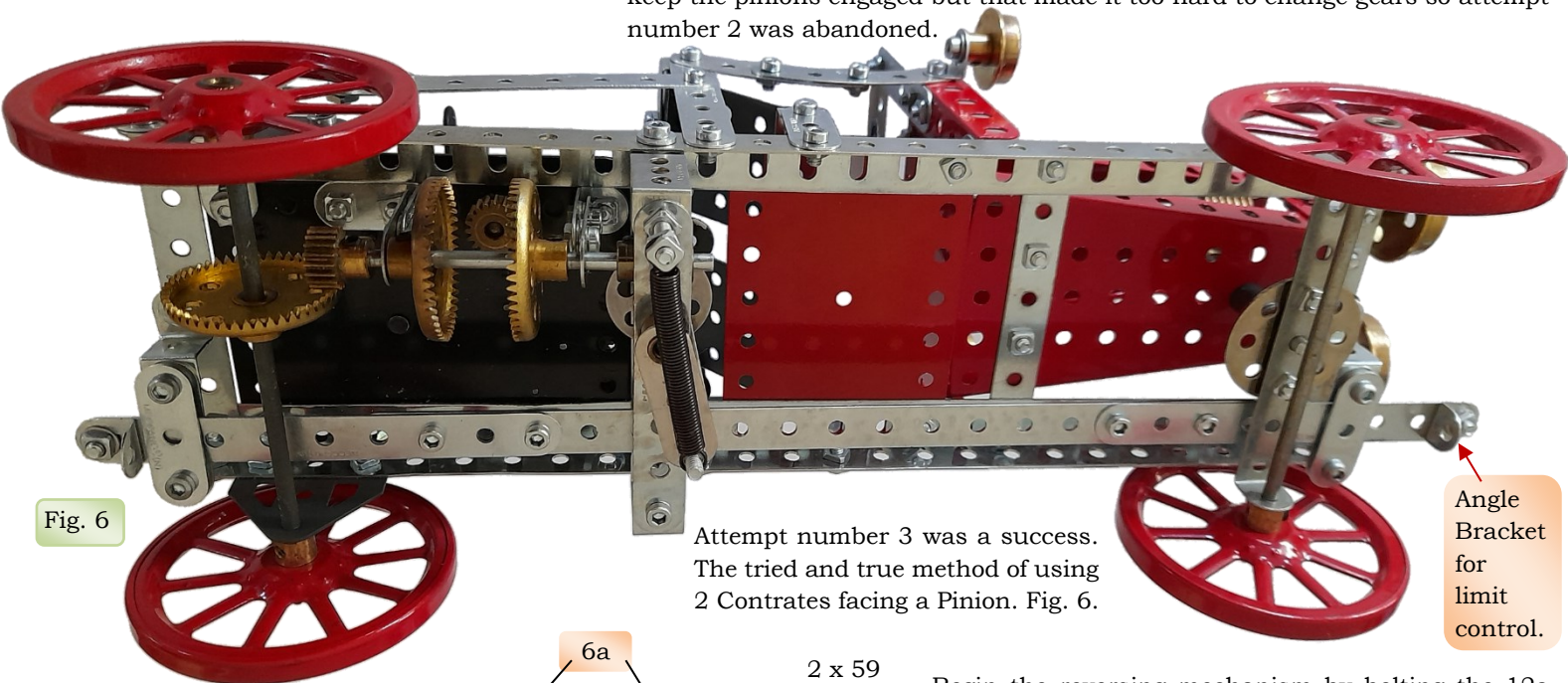

Fig. 6

Attempt number 3 was a success. The tried and true method of using 2 Contrates facing a Pinion. Fig. 6.

Angle Bracket for limit control.

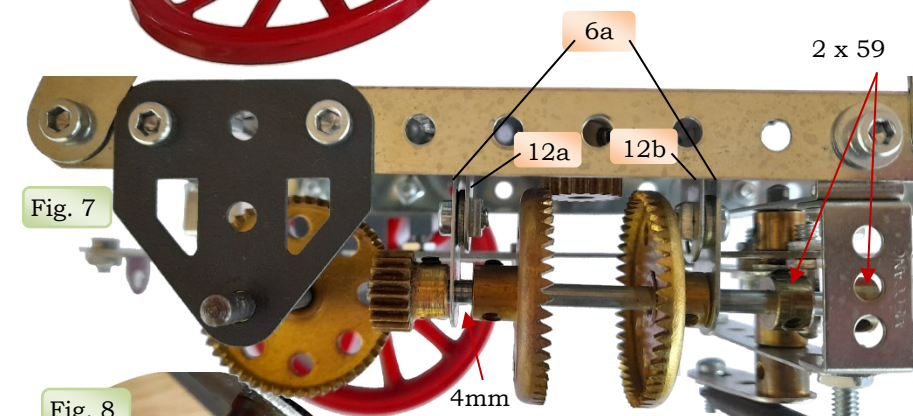

Fig. 7

Begin the reversing mechanism by bolting the 12a and 12b Angle Brackets to the motor as shown in Figs 7 & 9. Then bolt 3 hole Strips to them but space them out with Washers to get the distance between the Strips correct. The Contrates need about 4mm of movement. You may need to align the teeth on the Contrates to get them to mesh seamlessly with the pinion if it's stationary but once things are moving it doesn't really matter. To move the Contrates I've used a Threaded Pin in a 1" Bushwheel the fits between 2 Collars on the 3/2" Rod. Fig. 10.

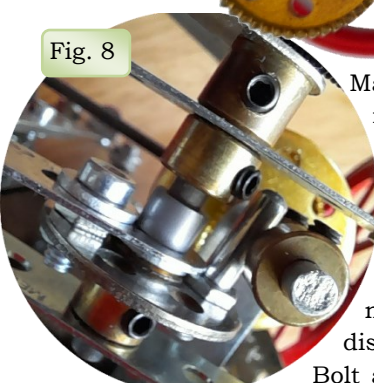

Fig. 8

Make a frame for the toggle mechanism using 2 x 7 hole Strips with a 1" x 1/2" DAS at each end. Bolt this frame to the 12 1/2" Angle Girders using Angle Brackets. Make sure the slot is on the Angle Girder to allow you to move the frame up and down for adjustment. You may need to use Washers depending on the distance between the 12 1/2" Angle Girders.

Bolt a Slotted Strip to the 1" Bushwheel as shown in Fig. 8 using a Nut as a spacer to raise the Slotted Strip above the peened ridge on the Bushwheel and the Nut on the Threaded Pin.

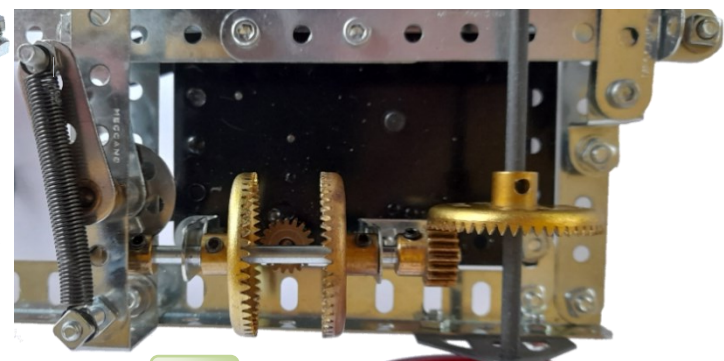

Fig. 9

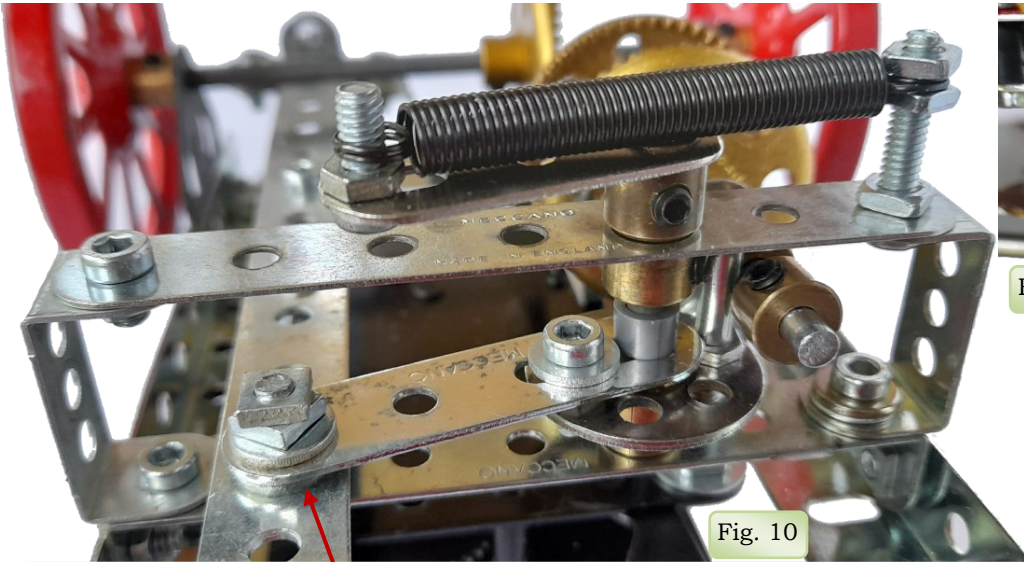

Fig. 10

Much easier to use a BC1 (locknuts) than try and connect a Rod to the Slotted Strip

In Fig. 10 above you might wonder why there's a small grey plastic Spacer sitting on top of the Slotted Strip. It's simply left over from some other ideas I was trying and I forgot to remove it.

After you've tested the movement of the Threaded Pin and have the Collars either side of it adjusted correctly, add the Crank which is used as a toggle. These toggle mechanisms are fascinating, and they come in various forms but I've chosen the Tension Spring method. The end of the Crank swings in an arc so the Tension Spring is stretched as it travels from left to right. This results in the Crank tending to stay either left or right as it has to overcome the tension to move. If not for this clever little mechanism the Crank would be content to remain in any state and the Contrates would fall out of mesh with the Pinion on the Clockwork Motor.

The final step is to connect the Slotted Strip to the Strips that run from one end of the car to the other. I first tried Rods but they proved less reliable than the Strips as the Rods required a Coupling to connect to the Slotted Strip and they tended to turn. By using the Strips that were free to slide between 3 hole Strips at either end, I was able to keep them level and save space. See note on Fig. 10.

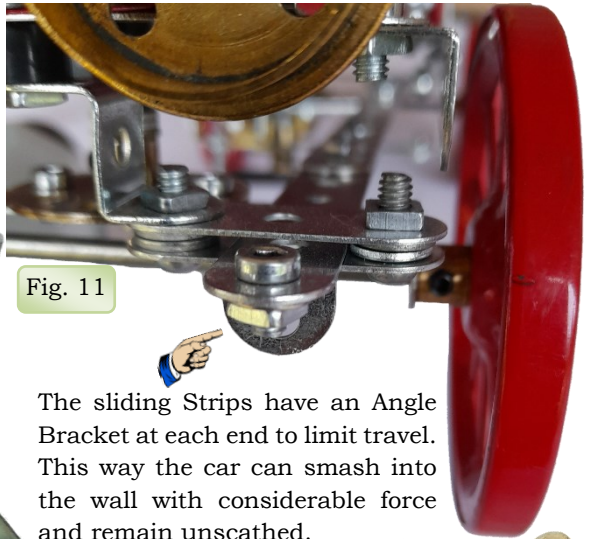

Fig. 11



The sliding Strips have an Angle Bracket at each end to limit travel. This way the car can smash into the wall with considerable force and remain unscathed.

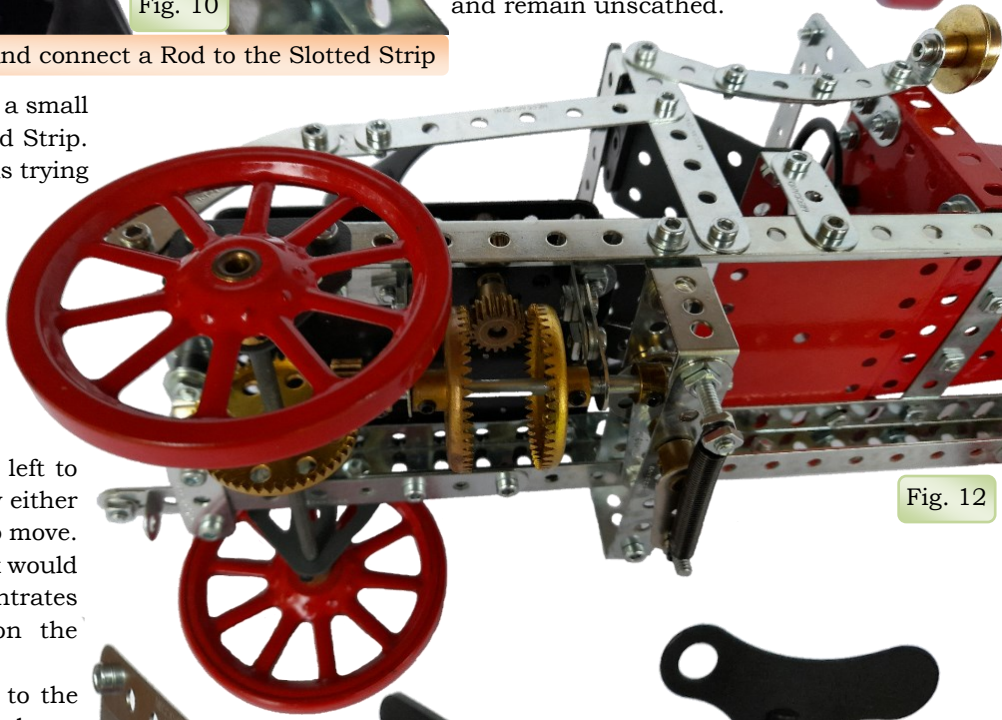

Fig. 12

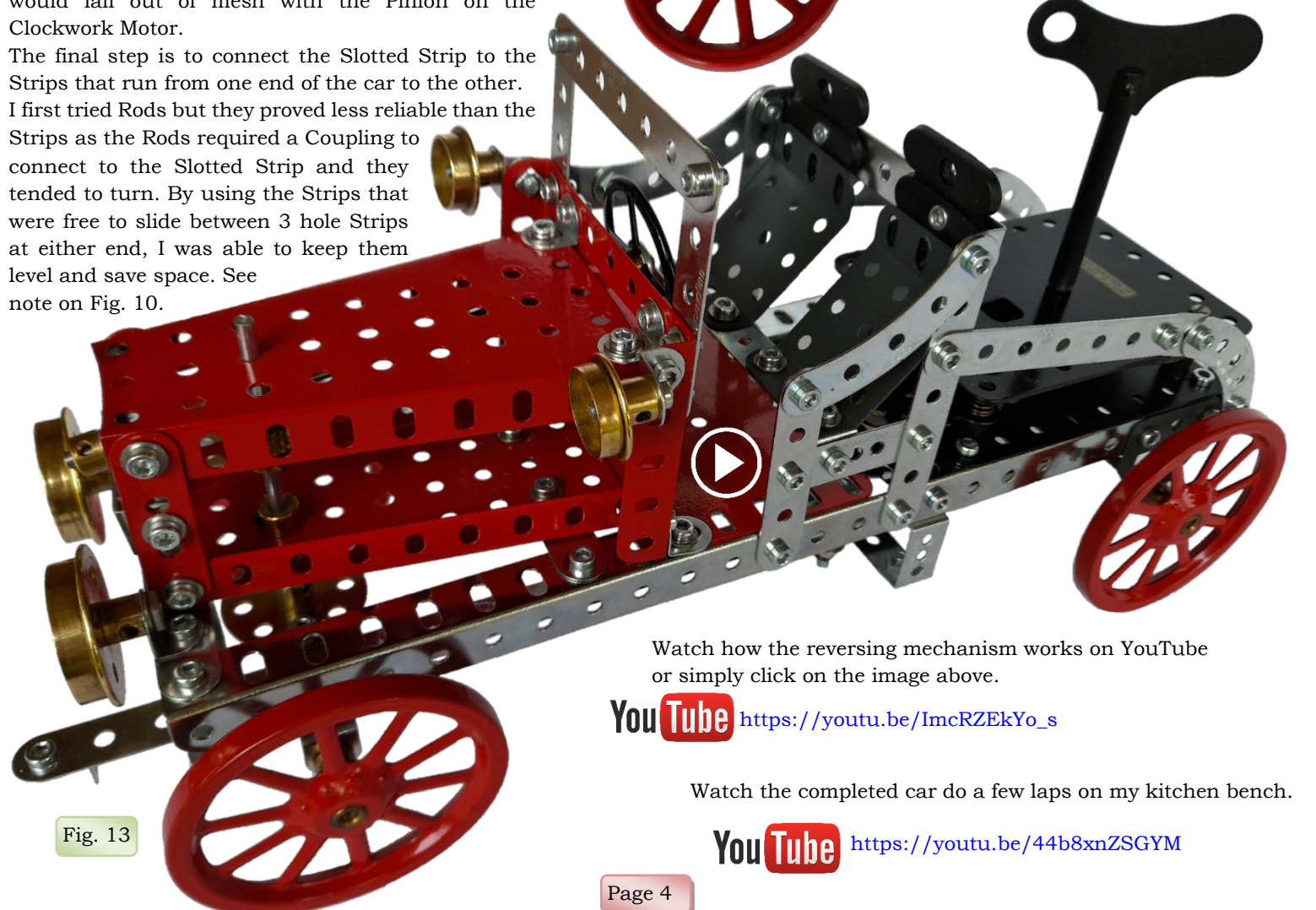

Fig. 13

Watch how the reversing mechanism works on YouTube or simply click on the image above.

**You Tube** [https://youtu.be/ImcRZEkYo\\_s](https://youtu.be/ImcRZEkYo_s)

Watch the completed car do a few laps on my kitchen bench.

**You Tube** <https://youtu.be/44b8xnZSGYM>

# Cleaning brassware



Douglas Hedgley



Click on the image to see Doug's fine effort



Douglas Hedgley in the UK posted an excellent video showing his outstanding results when cleaning Meccano brassware using an ultrasonic cleaner and a product called Quickshine Brass & Copper Bath. Keen to emulate his success, I dragged out our ultrasonic cleaner, much to the wife's chagrin.



My new ultrasonic cleaner

Unfortunately, it blew a fuse when I was careless with the water and my attempt to solder in a new fuse resulted in its total destruction. I had inadvertently squashed the red wire (arrowed) between the basin and the heatsink of one of the transistors and released the magic smoke. Don't you just hate it when the wife says "I told you so" in that judgemental voice. So, it was off to eBay and 3 days later I had a new ultrasonic cleaner complete with a heater that was more in line with what Doug used.

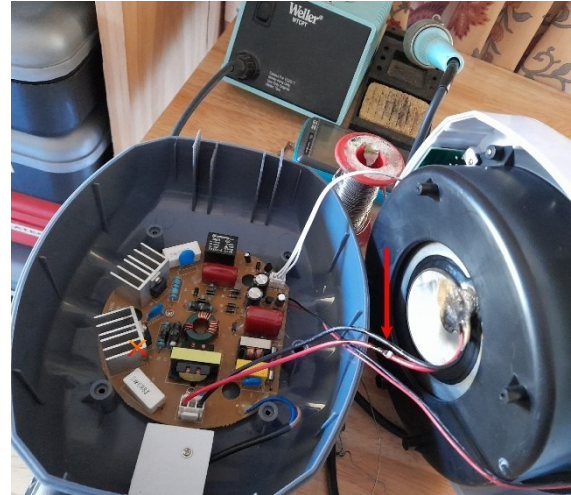

Unable to find Quickshine locally, I used a 50/50 mix of vinegar and water with a dash of dishwashing detergent and set about cleaning up a bunch of grubby brass gears. After 30 mins they still weren't shiny so I gave them another 30 mins resulting in the disaster you see below. The pinions and couplings were copper coloured, and the gears were, well, see for yourself.

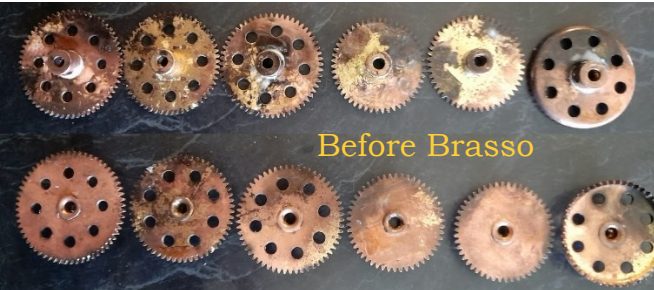

Before Brasso



After Brasso



After ultrasonic cleaning

**Disaster**



After ultrasonic cleaning

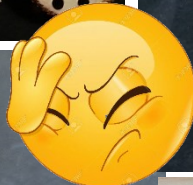

After spray painting

Even the zinc had either turned black or been removed. To fix the Pawls and Cranks, I dipped them in hydrochloric acid to remove the zinc completely then sprayed them with etch primer and finally satin black from a cheap spray can. Then 30 mins at 120c in the toaster oven and they looked fine. The collars and couplings were easy as I knew from past experience that Brasso restores the copper look back to the nice shiny brass look. Disaster partly fixed.

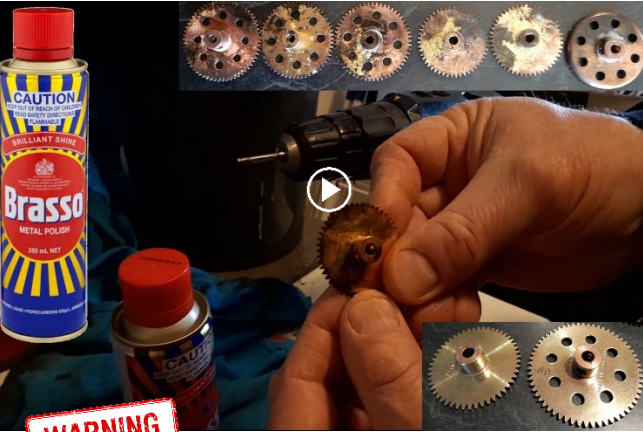

**WARNING**

Watch fingers



Next step was to repair the damaged gears and after discussion with other Meccano experts, I learnt that the blotchy mess was caused by a layer of lacquer that is applied to the 50t and 57t gears. To get through it, you would need to rub it with Brasso for hours. This is where the cordless drill method really excels. Before I started the heavy duty polishing, I checked that they were all solid brass and not just brass plated steel by using a magnet. Steel is magnetic. Brass is not. Watch a video of me doing it by clicking on the images to the left or follow the YouTube links below.

**YouTube** <https://youtu.be/5MoLdjwMCAM>  
[https://youtu.be/swDPnJF\\_XyI](https://youtu.be/swDPnJF_XyI)

In summary, I would say that ultrasonic cleaners are for cleaning. Perhaps they can make some brassware shiny but nothing compares to the abrasive quality of Brasso to really get the shine on badly weathered brass like the examples I used here. Maybe I'll try Horolene next?

**SILVER SURFER**



If every cloud has a silver lining, then as boat models go; my ship has finally come in! Fresh off the back of constructing my most recent ship, the one where I gave up trying to build a curved hull, I decided to give it one more focussed effort and cut through the surf once more. I started the first day giving it only two hours, putting together two sets of curved strips for both sides and some angle girders across, but it felt like I was on to something. By the time I started back on the model on the Monday and with the building of one side of the hull only, I decided I would go on to create the model to be viewed from one side only. By the mid-afternoon the front side was built with towers, decking and other details, I was delighted with the look the model was taking in light of the fact that I went about only using chrome-coloured parts to construct it. Within a few days I had done most of the design construction, including an anchor, several cannons and the rudder. For all the openings for the cannons I used red small flat plates which I think looks striking against the ship's silver façade. Enthused with the golden progress I was making, I kept adding small details and on day six I added the riggings, a flag and built a platform for the model to stand on. At this stage I decided not to add any sails to the model. When all masts were done, small red plastic pulleys were used to tie some of the riggings but on the other side without a proper hull, I used supporting struts so the whole model was solidly and properly held together as strongly as possible. With so many previous ships and galleon-based models built before, I never felt the need to construct in 360-degree completion, as here my main objectives were to explore the curved hull and to build using parts mainly in silver. That said, to balance the cannon hatches and to offset the masts; I decided to construct the crow's nests in red as a contrast.

The completed size is approx. 1.2m in length x 1m in height and overall, the model is heavier than expected. The three additional masts at the top are removable for ease of transport, as such not all the riggings are attached to each other so that they can be lifted off without problem. I can't believe I have built yet another ship, but I just had that itch to scratch and now I'm happy.

I have always tried with my Meccano ship models, to reach for some golden horizon, agonisingly just out of view, though it was the waves of my own imagination that always seemed to thwart me from feeling like I had reached my final destination. There is no bigger challenge or ocean vast enough to equal how hard it is to circumnavigate the waves of the human mind, but perhaps my 'Silver Surfer' will help me find the golden horizon that's always been there just out of reach.

The Silver Surfer – making waves for horizons gold!

**Built in  
June 2023  
by  
Santiago  
'James'  
Plicio**

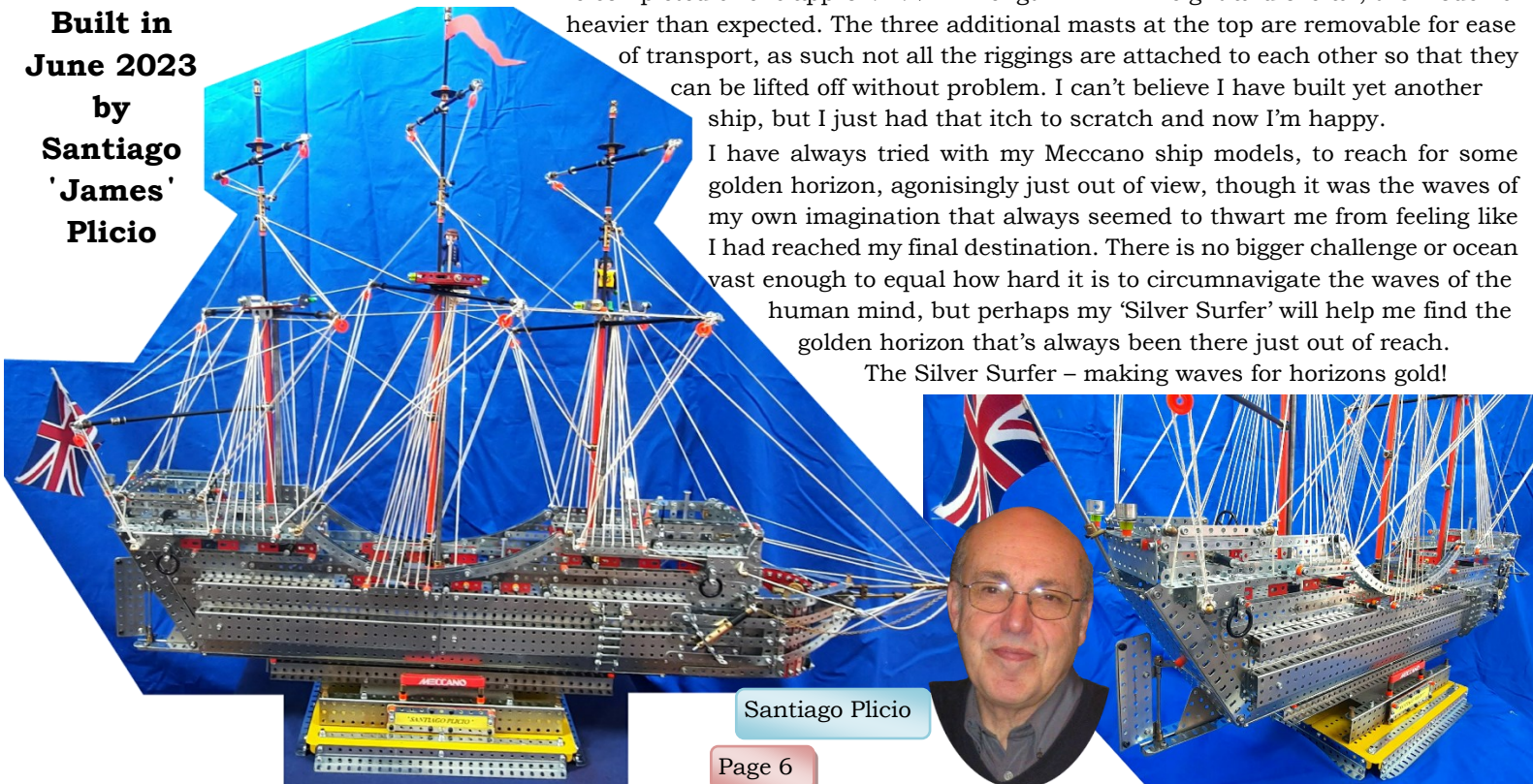

Santiago Plicio

# Constant Direction Windmill



At the Sydney Expo, Paul Dale had a Constant Direction Windmill based on a mechanism in [CQ 16 June 1992](#). Fig. 4.

The word CLOCKWISE was clearly displayed at the front under the crank, and we had so much telling the kids they were turning it the wrong way.

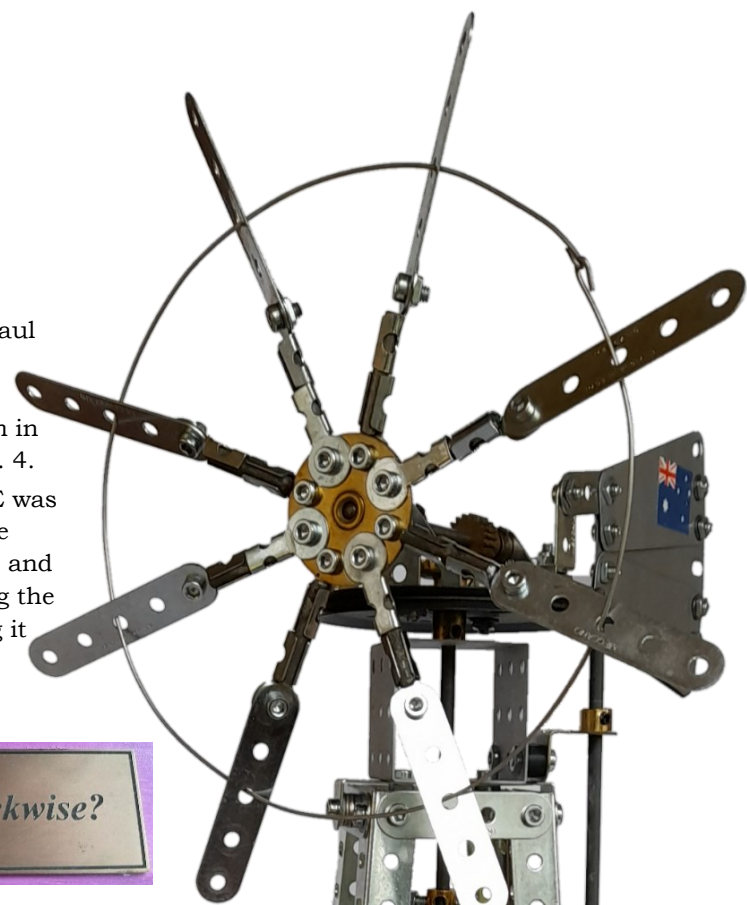

Part	Description	Qty
2	Strip 5½"	4
2a	Strip 4½"	6
3	Strip 3½"	7
5	Strip 2½"	12
6	Strip 2"	4
6a	Strip 1½"	7
8	Angle Girder 12½"	4
9c	Angle Girder 3"	4
10	Fishplate	4
12	Angle Bracket	6
12b	Angle Bracket 1" x ½"	5
13	Rod 11½"	2
15b	Rod 4"	1
16b	Rod 3"	1
18b	Rod 1"	8
19g	Crank	1
19b	Pulley 3"	1
23c	Pulley ¾" Rubber	1
24	Bushwheel 8 hole	1
26	Pinion 19t	1
27f	Multipurpose Gear	3
29	Contrate 25t	1
38a	Plastic Spacer	2
48a	DAS 2½" x ½"	1
48e	DAS 1" x ½"	1
51	Flanged Plate 2½" x 1½"	3
52	Base Plate	1
59	Collar	7
63	Coupling	1
126	Trunnion	6
163	Cube 3x3x3	1
211a	Helical 14t	2
212	Rod Strip Connector	16
B582	Flex Plate Trapezoidal	3
	Wire stainless steel 1mm	~19"

"No, No! the other way!" we'd exclaim but of course the trick was, no matter which way they turned the crank, the blades turned counter-clockwise. It was absolutely hilarious!

Pauli sent me a close-up photo of his mechanism, but I found it difficult to follow.

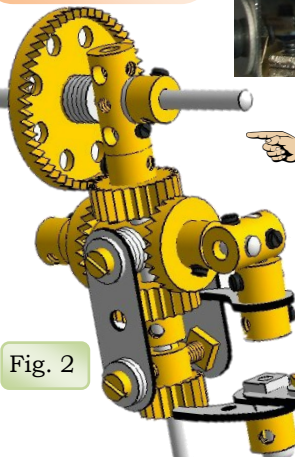
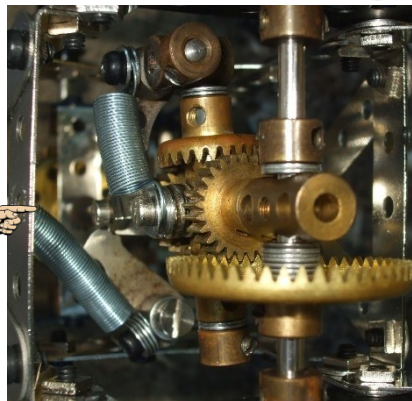

Fig. 2

Ed Veiga drew the Tomkinson-Denny constant-direction drive in Virtual Mec but he had trouble finding the pre-war style double-sided pawl and the springs in VM.

It was now a bit easier to understand but I was still looking for something different.

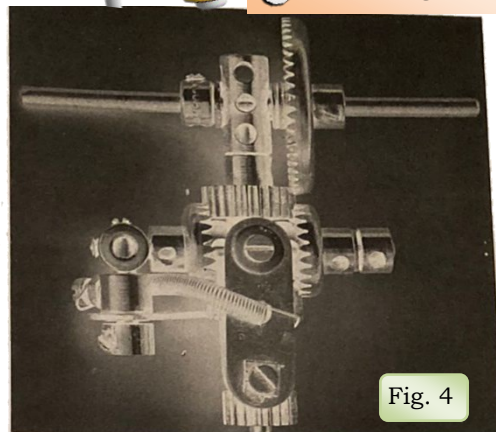

Fig. 4

Fig.3 Tomkinson-Denny constant-direction drive in all its amazing complexity! A Pawl attached to the frame of the windmill engages the 19t Pinion at the bottom end but was forgotten by the photographer.



Fig. 3

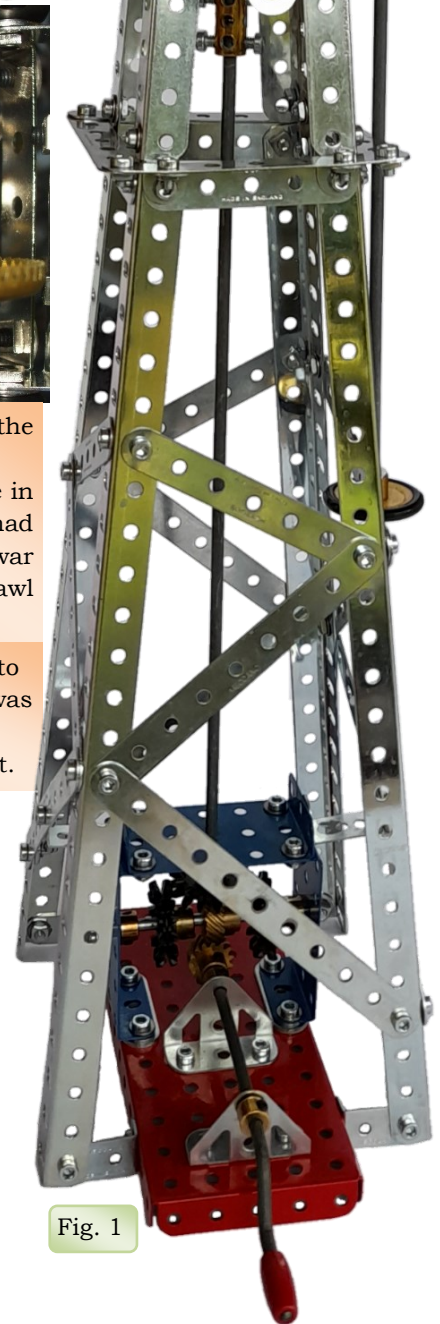

Fig. 1

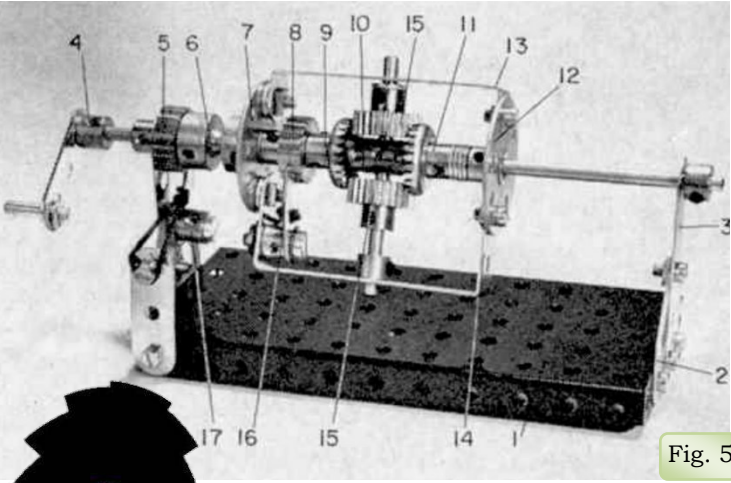

Fig. 5

Ed persevered and sent me lots more VM drawings of various constant-direction mechanisms.

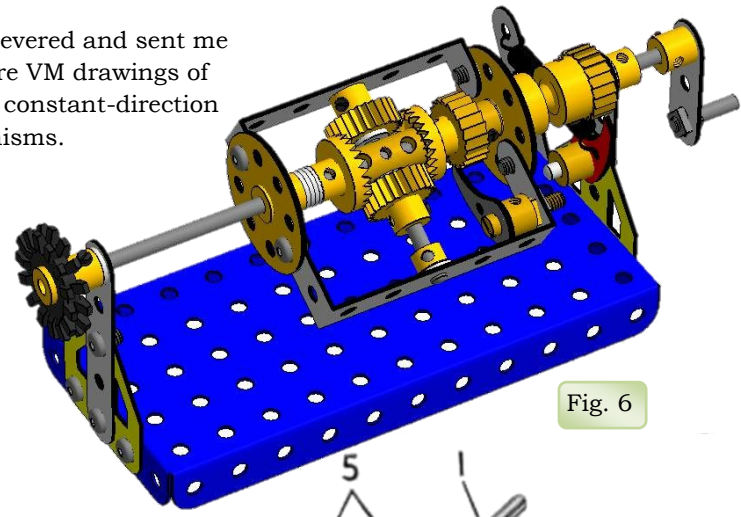

Fig. 6

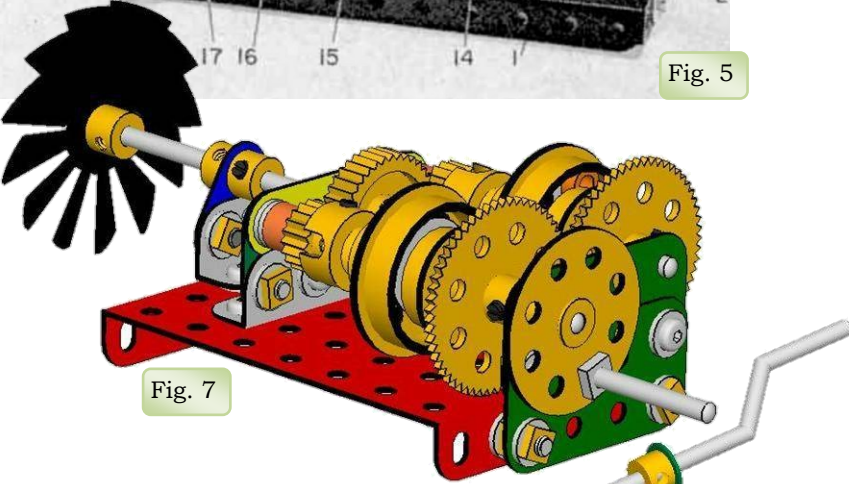

Fig. 7

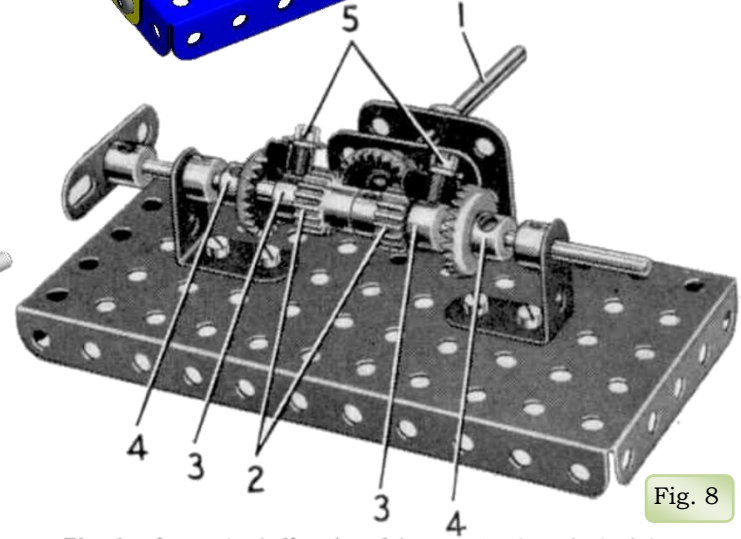

Fig. 8

Fig. 1. A constant direction drive mechanism devised by Mr. G. Welch, Piddletrenthide, Dorset.

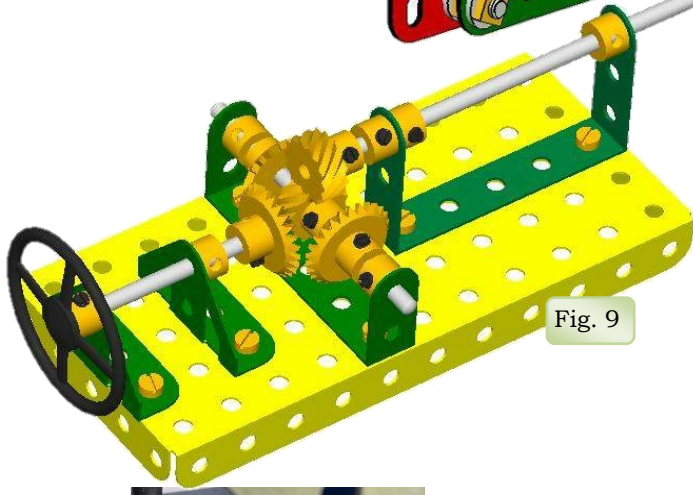

Fig. 9

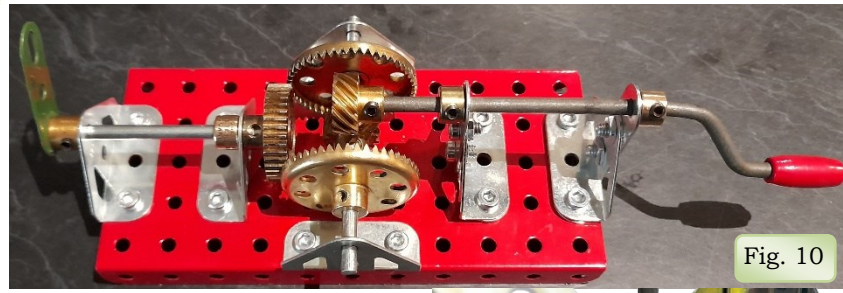

Fig. 10

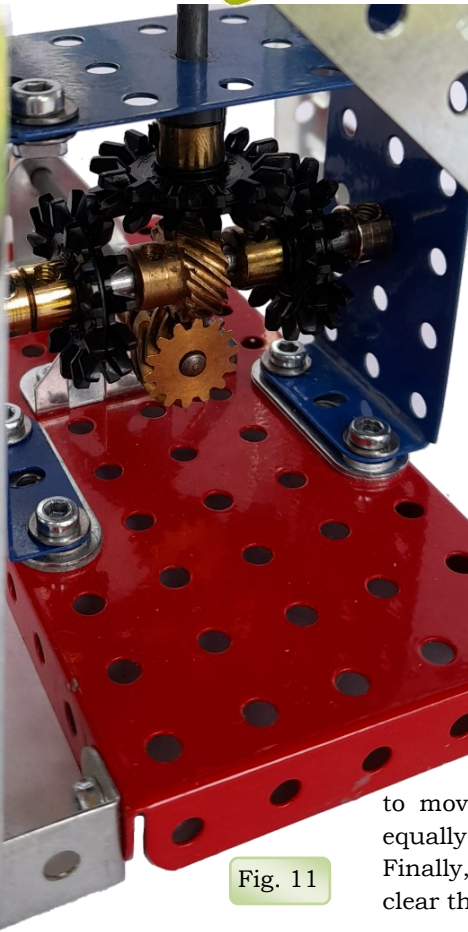

Fig. 11

The version in Fig. 9 appealed to me as it was so simple. As the top Helical turned clockwise, it pushed to bottom Helical to the left, and when you reversed the direction it was pushed to the right. This movement was used to engage either the left Bevel or the right Bevel with the centre Bevel thus maintaining a constant direction on the output shaft. As Bevels aren't a common part, I replicated this easy to understand mechanism using 50t Contrates and a 1" Gear instead. It worked just fine but was rather clunky and when a load was placed on the output shaft, it tended to jam. Richard Payn suggested using the 27f Multipurpose Gears instead and it worked a treat! Fig. 11 & 12. As the build progressed, I moved the output 27f to the top so that the long output Rod went straight up to the blades. The frame to house the mechanism is made up of 3 x Flanged Plates mounted on 2 x 3 hole Strips and 2 x thin washers to get the top Helical lined up nicely with the bottom Helical. You may need to fiddle around to get them to mesh smoothly. Lock the top Helical to the centre of the sliding Rod and leave the Multipurpose gears loose for the time being. Adjust the Collars to allow the Rod to move 5mm either way making sure the top Helical moves equally either side of Top Dead Centre of the bottom Helical. Finally, adjust the two bottom Multipurpose Gears so that they clear the top MPG.

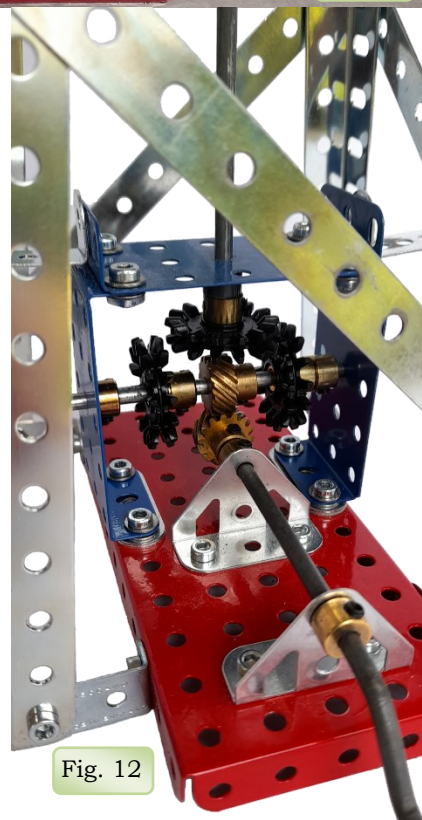

Fig. 12



Steve B took this beautiful photograph in the Flinders Ranges, South Australia.

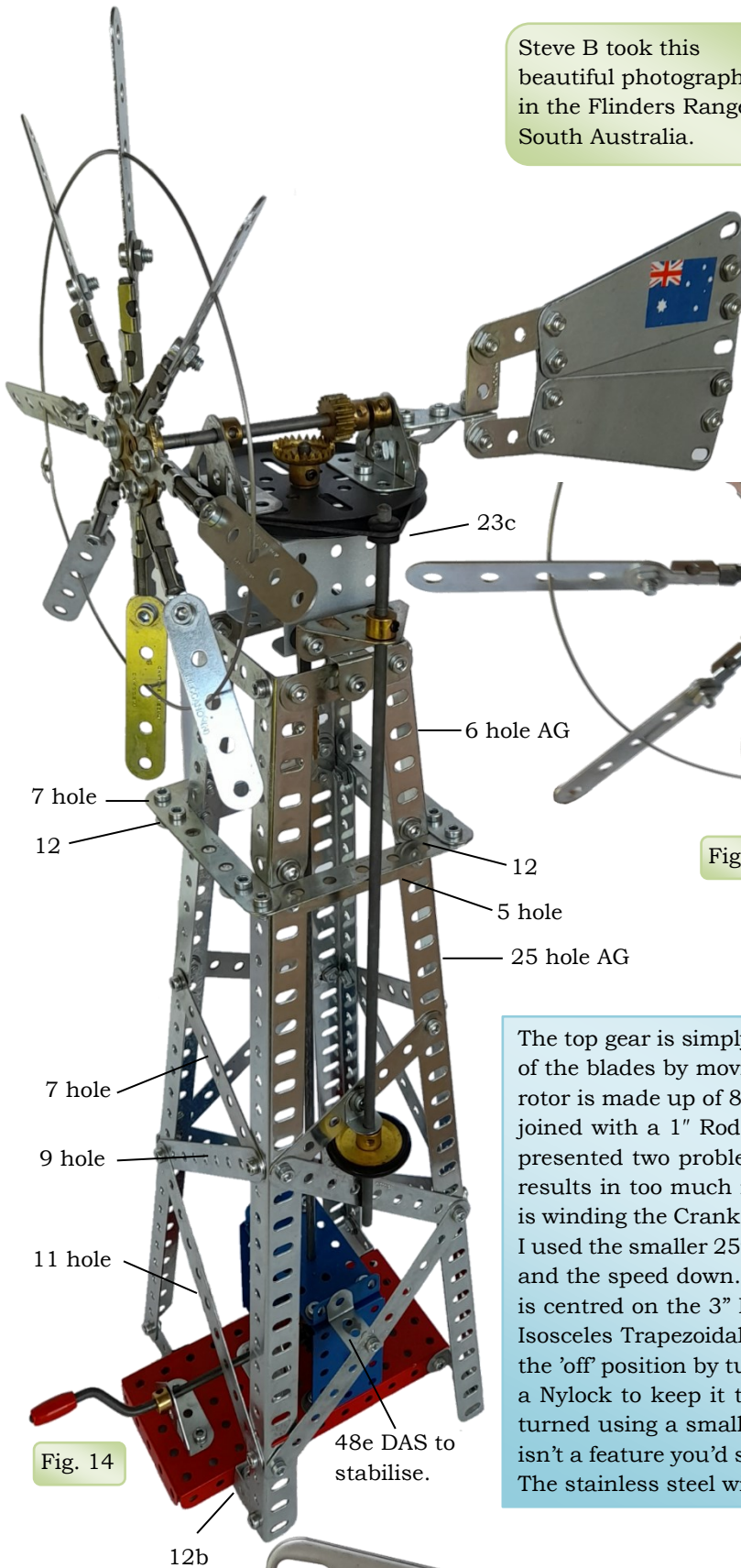

Fig. 14

Fig. 13

The top gear is simply a 25t Contrate and a 19t Pinion. You can change the direction of the blades by moving the Pinion to the other side of the Contrate if you wish. The rotor is made up of 8 blades each being a 5 hole Strip and 2 x Rod/Strip Connectors joined with a 1" Rod. In real life there would be more blades, perhaps 18, but this presented two problems. There are only 8 holes in the Bush Wheel and the weight results in too much momentum. Imagine 16 blades spinning furiously as some kid is winding the Crank as fast as they can and then it's reversed. For this same reason, I used the smaller 25t Contrate rather than the 50t. You need to keep both the weight and the speed down. You also need to balance the rotor and the vane, so the weight is centred on the 3" Pulley. This can be done by adding Strips in-between the B582 Isosceles Trapezoidal Flexible Plates. (What a mouthful!) The vane can be turned to the 'off' position by turning it 90 degrees to keep the rotor facing out of the wind. Use a Nylock to keep it tight but moveable. Likewise, the entire rotor and vane can be turned using a small 3/8" Rubber Pulley and a Pulley Belt to turn the 3" Pulley. This isn't a feature you'd see in a real windmill, but it gives the kids another thing to turn. The stainless steel wire can be anywhere between 1mm and 2mm thick.

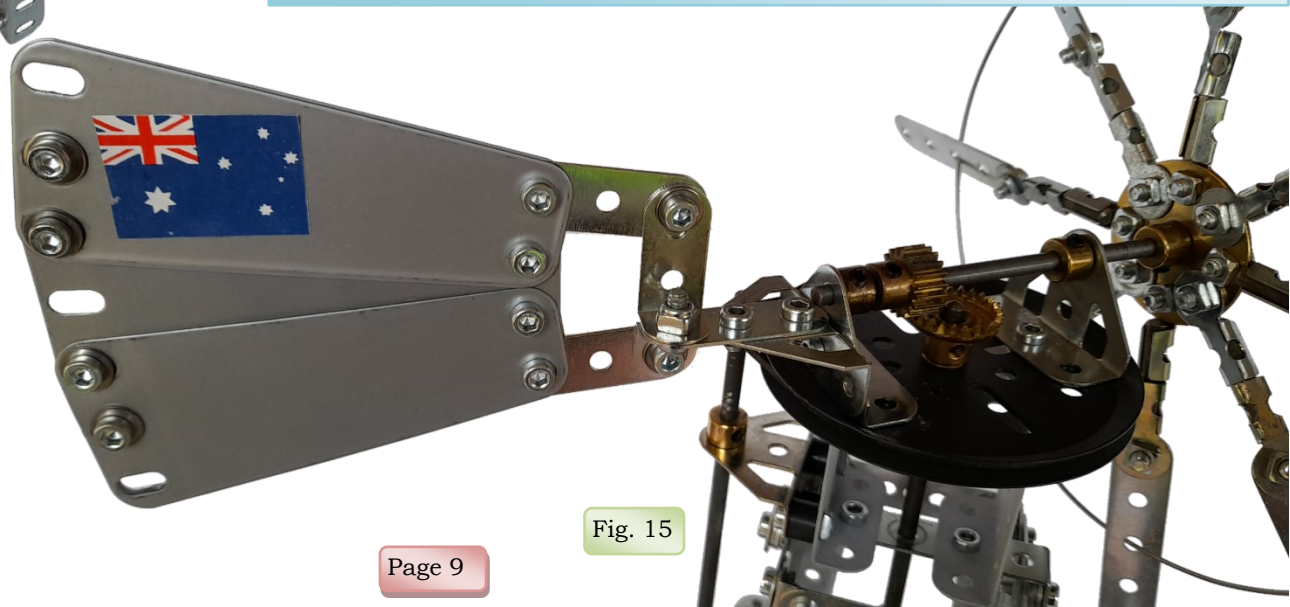

Fig. 15



On  
The  
Road

# Model Engineers Expo

Sep 16 - Melbourne Not only but also.



Jim  
Munro



Graham  
Jost



Chris  
Curnick

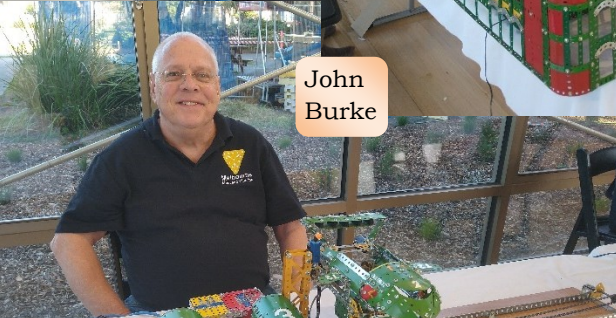

John  
Burke

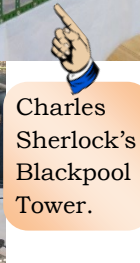

Charles  
Sherlock's  
Blackpool  
Tower.



Graham  
Jost

The Melbourne Meccano Club was honoured to be invited to exhibit at the Melbourne Society of Model and Experimental Engineers Expo. Not only Meccano but also model planes, tanks, clocks and all manner of engineering models under the umbrella of 'Makers'.



Mike Maloney

Roly  
Gauman



Anthony Burkitt  
and his Star Trek  
Enterprise.



See all the  
photos here.



Charles  
Sherlock



# My 2 Bob's Worth

## The Heroic Early Years of Meccano Boy.

by Doug Hedgley.



I believe what I have written to be correct, but happy to be corrected with superior knowledge.

When you dig into old articles/items about Meccano, some surprising issues come to life and here, on request, are a few of the items on the, less than safe, aspects of being a Meccano boy!

**1.** In the early days of Meccano, many houses did not have mains electricity and if they did, it was often DC of a varying voltage. If young Cedric had built the model car chassis and needed to run it, a non-rechargeable dry cell battery, would be out of the question as a motor would drain it in no time flat (see what I did there?). Meccano in their wisdom came up with the rechargeable 4v glass accumulator which is essentially a car battery on the small scale, and this worked, supplying plenty of amps as needed. Unfortunately, being full of sulphuric acid, they could and did leak, potentially burning small boys and carpets. Mothers were less than enchanted with the burn lines across her carpet and linoleum from the dribbling accumulator, as Cedric demonstrated his working model triumph! So, the operating history of the accumulator was relatively short and not too sweet, and is why they're worth a small fortune now, as most of them seemed to have been lobbed into the nearest dustbin!

**2.** The earliest mains powered Meccano Hornby 'O' gauge railway sets were arranged to plug into a light socket! (There were all sorts of arcane regulations then, about just how many power sockets were allowed to a room (so many square feet to the socket would you believe!) and they were mostly 2 pin, with no earth. Even when I was a kid in the early 50's, it was quite normal for the lady of the house to remove the light bulb and, using an adaptor, plug her clothes iron into the light socket (no earth). Meccano even produced a piece of equipment all mounted on polished wooden boards that enabled you to drop the mains voltage by directing it through series-wired light bulb(s) to pull the voltage down from the nominal mains voltage into something lower. As I read it, a newly employed company chief electrical engineer was horrified to find that it was possible for young Cedric to get a serious belt of electricity when a loco came off the track, with Cedric somehow forming the, until then, missing Earth! Strangely enough, their electrical equipment became some of the best, with properly metal-enclosed transformers for the railway sets, made initially by Ferranti and the beautifully over-engineered cast metal speed controllers for Hornby railways of the 50's that I remember. A little thought that just popped into my head: I have a good few of the pre-war Meccano transformers in their metal boxes and one of the oddities to modern eyes is the lolly-pop type wooden stick wedge that was professionally jammed by the factory between the copper coils and the transformer's mild steel core laminates. This was to stop some of the hum emanating from the insufficiently tight mild steel laminations that were rattling in the 50 cycle (Hz) breeze! Lol.

**3.** Then there were the infamous circular saw blades, which I can personally confirm are very sharp! They were made from a very good steel, no rubbish here, and they would actually cut pencils and the like. If you made the model sawing machine up, there was an excellent chance of doing yourself a mischief.

**4.** We must not forget, in passing, the notoriously sharp corners of the early version of the flexible plates which came out in the 1930's. With a square cut corner, the thinner plates were like knife blades so they were, until someone had the bright idea that maybe, just maybe, it would be a good idea to modify the press tools to produce the rounded corners we came to love. I've got a box full of these square cornered flexible plates, and several times I've nicked my finger whilst counting the things.

**5.** As a youngster I attended school on many occasions with scarred fingers and perforated palms where the useless, but cheap to make, chromed, bent wire screwdriver, had slipped in my hand and off the bolt head slot, and stabbed me in the hand! Hooray for Allan keys!

**6.** There was of course lead in the paint up to the 1960's but I don't consider Meccano any worse than other manufacturers as that was the technology of the times and the dangers of lead were little, if at all, understood. Were we downhearted with the above dangers? No! 'cos we were 'ard...rock 'ard. Lol! In spite of these little hiccups, Meccano was and is still a class act as a toy. – Douglas.

### Question: What am I?

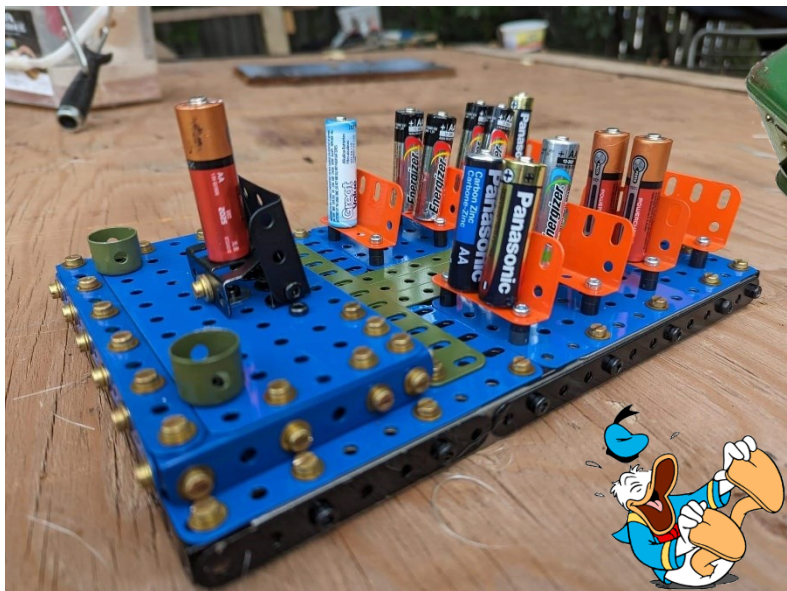

Contributed by Brent Simpson. Answer: An AA meeting.

# FROM OUR GOOD IDEAS DEPARTMENT

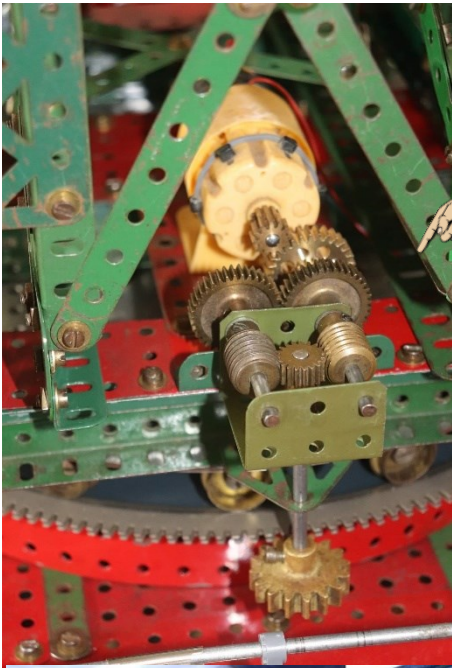

From Philip Webb – UK.  
A worm and pinion under load can sometimes jump apart, but not with a twin drive like this in my latest crane.

Use common O Rings for tyres.

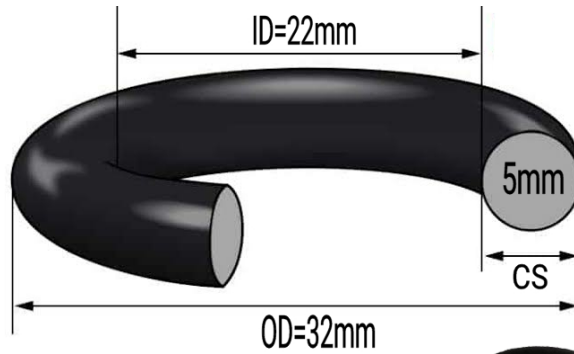

The round rubber tyres perish, and I was embarrassed when my small clockwork reverser veered to one side at our club meeting. The O Ring tyre had split! As all my tyres were old, I went to a bearing shop and bought some O Rings for 40c each. I found 22mm ID to be the best fit.



Coloured lamps to replace Elektrikit lamps are very difficult to obtain however there are many Edison screw type lamps that match the Elektrikit 540 lamp but they're all clear. The solution is to dip them in this Tamiya X-25 and X-27 clear paint. I just dip then blow on them lightly. It dries in seconds.



Note:  
Most sellers specify O Rings by the Inside Diameter and the Cross Section.  
The Outside Diameter is the  $ID + (2 * CS)$

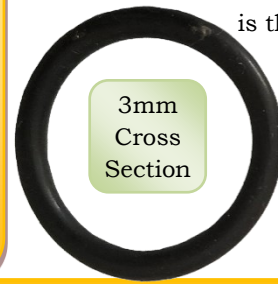

From Fabian Kaufmann – Germany.

A Pinion drives the 60t Gear with the Eccentric bolted to it. There is just enough clearance for the Pinion. The arm of the Eccentric is bolted tightly to the Fishplate. A Threaded Pin is bolted tightly to the other end of the Fishplate. The Threaded Pin moves freely in the 5 hole Coupling and the Coupling then moves the lower Rod transversely for the reversing mechanism in the gearbox.

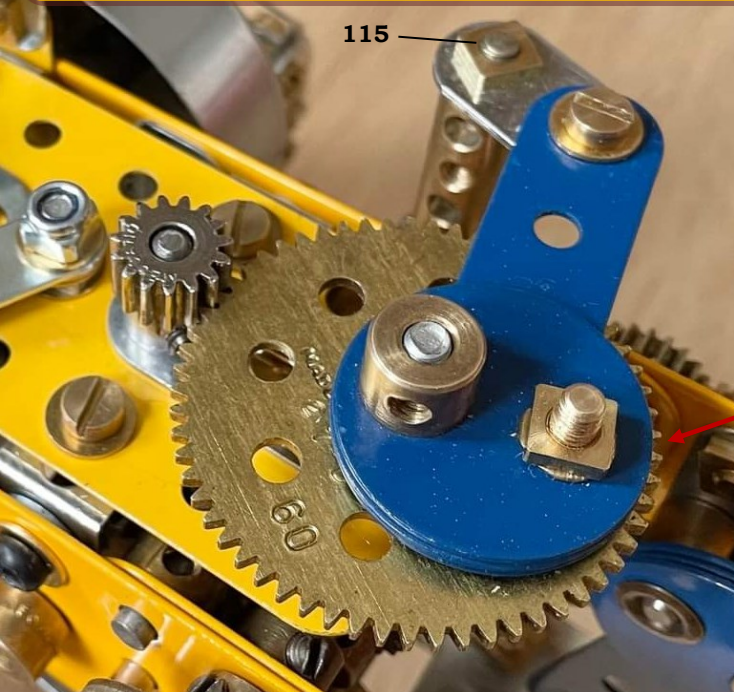

115

Just enough room.

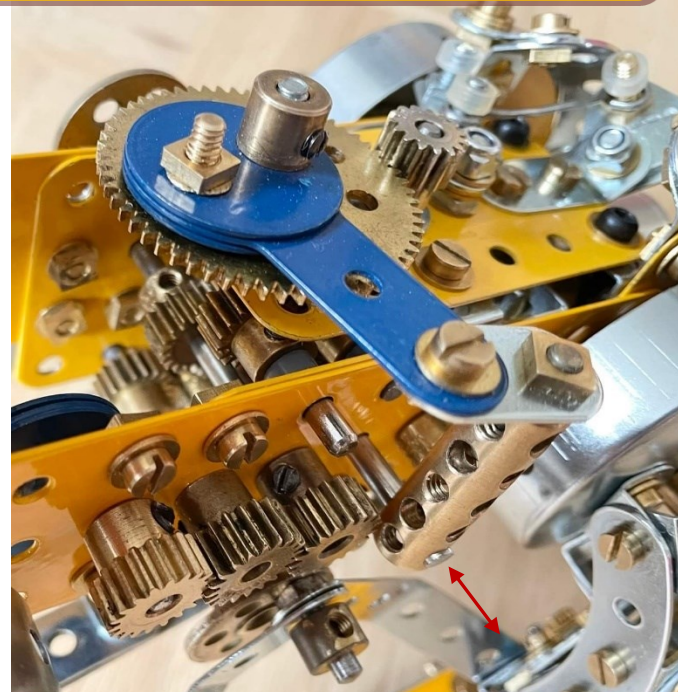

# This Month's Meccanoboy



**Georg Eiermann**  
- Germany



*When and where were you born?*

I was born in 1957, 99 years after Rudolf Diesel in Bad Wimpfen and grew up in a small village in the state of Baden-Württemberg about 30 km from Heidelberg.

*What schools did you go to?*

Primary school in our village, secondary school in Sinsheim (10km by train).

*What subjects did you study?*

After mandatory military service

study of mechanical engineering at the University of Karlsruhe (Diplom Ingenieur).  
Topics: combustion engines and automotive engineering.

*Did you have Meccano as a child?*

No. Only Märklin and together with my sister some Danish bricks and a lot of time outside the house.



L-R sister Regina, me, my mother Hildegard, my sister Friederike, my father Walter.

*Do you have children?*

A son, living and working in San Francisco for a big Silicon Valley company and a daughter, living 300m away and working as a controller for a church-run care home company.

*What did you do for a living?*

Few years for BMW, about 35 years for Mercedes-Benz. As designer (constructor) in the pre-development department for combustion engines from 3 cylinders up to very high numbers of cylinders. 25 patent applications (useful and/or nonsense) during that time, e.g. the basic layout of the engine of the first Mercedes A-Class was made by me. See picture of the prototype Vision A93 with "my" invisible engine. Later working in the patent department with a special topic: combustion engines.

The Vision A93 was a prototype show car, which became later the Mercedes-Benz A-Class.



With my daughter and my son in Yosemite 2017.



*Were there any fringe benefits of working in the luxury car industry?*

It's nice to be able to buy a new Mercedes at a discount once a year. But when the best cars are the daily work, they become boring over time. It is nothing extraordinary anymore, especially in the Stuttgart area where I am living. (Mercedes-Benz, Porsche, Bosch – all have a lot of great test cars on the roads). That's why I prefer to spend my remaining money on Märklin, Meccano and cameras. That also arouses less envy. And I loved my Citroen 2CV from the other end of the automotive range.

My treasured 2CV, about 2018



When did you get your 1st construction set?

Christmas 1964, a Märklin 1010 set, which grew with time to a 1013 plus some loose spare parts and 1072 motor.

Was there the usual hiatus where fast cars and girls took priority?

Between the age of about 16 to 40 years was a gap. But I kept my Märklin all the time.

How much Meccano compared to Märklin do you have? See pics. Some Meccano 10 sets and Märklin big sets/ wooden boxes are called "antique furniture" and therefore can be stored in the living room, e.g., under the sofa.

Estimated about 500 kg. Roughly evenly distributed.

Have you picked up any great bargains collecting Meccano and Märklin?

Through an intermediary I got Meccano a few years ago, which came from a former English school in a barracks in North Rhine-Westphalia. Only Meccano #1 and #2 but many yellow boxes, a total of 90 kg.

In addition, sometimes estates of deceased collectors with little Märklin.



Georg's 'Man Cave'.



Georg as a boy with his Märklin model railway.



What type of models do you prefer to build?

There are no favourites. I build cranes, locomotives, ball rollers, weird mechanisms, you name it. Large and small. I like to build things that make the spectator happy.



At the Golden Gate Bridge in 2017 on my 60th birthday.

Have you travelled much?

I celebrated my 60th birthday with my children at my son's home in San Francisco. Another visit to California to the wedding of my son and daughter in law followed by a short holiday.

At SkegEx2023 with Richard Payn (Chairman NMMG) and the Mayor of Skegness, Pete Barry.



With 2 of my Ten Sets in 2014.



What's your best model?  
My 7-Segment display. (Below)

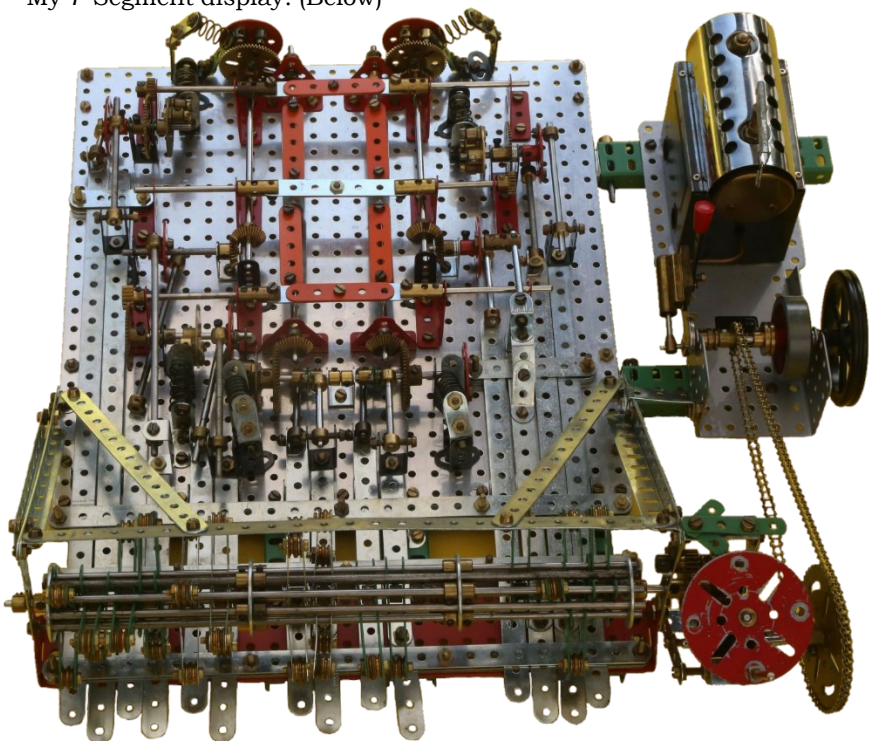

What are the main differences between Märklin and Meccano?

Meccano has always been that company's main product. The metal construction kit at Märklin was only a by-product alongside the model railways. You can see the difference quite well when you look at the different care, development and advertising for Meccano and Märklin. What I like about Meccano is the greater variety of parts (especially brass) compared to Märklin. Also, all the parts are coordinated and fit together, e.g. the blue wheels from Märklin do not fit into the 1/2" system because of the diameter and the number of holes. They were brought into the programme by someone who didn't know exactly what he was doing. What I like most about Märklin are the many small, black brackets. They are very useful. Many parts are identical, maybe except for thickness and paint/colour.

Which do you prefer and why?

When I build a model according to my own ideas, I use Meccano and Märklin parts as they just fit. I don't care about "system clean" or 100% matching colour. Green is green, whether light or dark. Another advantage of Märklin metal is that it is cheaper in Germany than abroad, and Meccano always comes across a border (postage + customs). I like my models driven by hand crank or electric motors (Märklin 1072). But no electronics. Everything with more than one cable comes directly from hell.

Watch it on **YouTube**  
Either click the image or the link.  [https://youtu.be/\\_4q2DsLSR10](https://youtu.be/_4q2DsLSR10)

What other hobbies and interests do you have? Railways, hobby-photographer <https://unsplash.com/@georgeiermann> and all kinds of old technology and old machines plus Jazz, Rock'n'Roll and Rock Music.

What prompted you to start writing your magazine *Schrauber und Sammler*? I knew Meccano magazines from abroad and there was nothing like that in Germany. And then I thought of the Meccano slogan: "If You Can't Have It, Build It". I started small, but in time I got enough reports from others to fill a magazine four times a year.

How much of your time does it take up?  
It's hobby time, there's no clock running.  
But it is less than you think.

To download Georg's magazine, click on the image or visit NZM here...

Pauli and Georg in  
Bebra, Germany, 2019.

## Schrauber & Sammler

Magazin für die Freunde des Metallbaukastens.

Ich schraube, also bin ich.

Nr. 20 Herbst 2021

 <https://www.nzmeccano.com/image-110519>



Have any Meccano folk visited you?

Dr Paul Dale wanted to visit me at home. But at the time our German meeting took place, and he attended it. Some German friends and two from Switzerland visited me at home. The late Douglas Laing from South Africa once visited a former colleague near Stuttgart and made a short trip to me. In any case: Meccano-visitors are welcome.

Have you visited any Meccano people in other countries?

If I go south by car, I'm in Switzerland in two and a half hours. So it is relatively easy to visit a friend there for two or three hours to chat and swap parts or look at models. There is a lot of Meccano in Switzerland, but it is outside the EU and a postal package is expensive and costs customs duties. A personal visit by car provides other opportunities. I visited a friend in England once after a visit to Skegness and stayed there for more than one night. We talked about Meccano and visited technical museums in and near Manchester. We are still in contact.

Have you been to expos in other countries?

SkegEx (2006 first time, 2012, 13,14,15,16,17,18, 22 and 23). CAM-Expos in France (2009, 10, 11, 14, 17, 19 and 22). AMS- Expos in Switzerland (2010, 15, 20) All German meetings since the beginning in 2002, (except 2020).

Loading a model into my car after a meeting in 2011.



Has Meccano and Märklin helped you in life?

It gave me a basic understanding of mechanical engineering in my youth and gave me a lot of friends worldwide in my adult life.

Any regrets?

Every Märklin or Meccano Set I sold.

What's your advice for young people today?

Do what brings you joy, and then you will do well and succeed.

We are John & Johnny. A father and son team who like Meccano. We're nothing to do with Spin Master who own the brand. Contact us at

[MeccanoNews@gmail.com](mailto:MeccanoNews@gmail.com)

Follow Johnny Meccano on



Three conspiracy theorists walk into a bar. You can't tell me that's a coincidence.

facebook

UK

<https://tims.org.uk>

<https://nelmc.org.uk>

<https://nmmg.org.uk>

<https://www.selmec.org.uk>

<https://southwestmeccano.org.uk>

<https://londonmeccanoclub.org.uk>

<http://www.hsomerville.com/wlms>

<http://www.northwestmeccano.co.uk>

<https://northeasternmeccano.org.uk>

<https://www.meccanoscotland.org.uk>

<http://www.corlustmeccanoclub.co.uk>

<https://runnymedemeccanoguild.org.uk>

<http://www.midlandsmeccanoguild.com>

**Other Countries**

<http://club-amis-meccano.org/>

<http://www.meccaninfos.com.ar/>

<http://www.meccanogilde.nl>

<http://meccano.free-bb.fr/>

<https://www.aceam.org/es/>

<http://www.la-roue-tourne.fr/index.php/le-meccano/notices-et-plans>

<https://www.metallbaukasten-forum.de/>

<http://www.amsclub.ch/>

<http://www.meccanoweb.es/>

**USA and Canada**

[https://www.spinmaster.com/brand.php?brand=cat\\_meccano](https://www.spinmaster.com/brand.php?brand=cat_meccano)

<https://www.usmeccano.com>

<http://www.meccano.com>

<http://www.cmamas.ca>

<http://www.bcmeccanomodellers.com/meccano-in-canada.html>

<http://www.meccanoquebec.org/index2ang.html>

<http://www.melright.com/meccanosales/>

**Australia & New Zealand**

<http://www.nzmeccano.com>

<http://www.nzfm.co.nz>

<http://www.mmci.com.au>

<https://www.facebook.com/MWT-Meccano-Club-1476153515979522/>

<http://www.sydneymeccanomodellers.org.au>

<http://www.webjournalist.com.au/maylands/index.html>

**South Africa**

<https://www.facebook.com/Meccano-Club-of-South-Africa-464753870326296>

<http://www.mecworld.co.za/cmrf/>

**Personal pages**

<https://neilsmeccanoandstuff.jimdofree.com/neil-s-meccano-models>

<http://www.users.zetnet.co.uk/dms/meccano>

<http://www.dalefield.com/meccano/index.html>

<https://www.alansmeccano.org>

<https://www.meccanoindex.co.uk>

<http://www.meccanokinematics.net>

<https://meccanocreations.in>

<http://www.meccano.us>

<https://mecca-clocks.fr/>

<http://mattgoodmanuk.com/links/Meccano.html> **NEW!**

**Meccano suppliers**

<http://www.meccanohobby.co.uk>

<https://www.meccanoshop.co.uk>

<http://meccanoman.co.uk/catalog>

<https://www.meccanospares.com>

<https://ralphsshop.com>

<http://www.meerlu.com.au/>

<https://tinyurl.com/AshokBanerjee>

<http://www.hsomerville.com/mwmailorder>

<http://www.metalconstructiontoys.com>

A young boy enters a barber shop and the barber whispers to his customer, "This is the dumbest kid in the world. Watch while I prove it to you."

The barber puts a dollar bill in one hand and two quarters in the other, then calls the boy over and asks, "Which do you want, son?" The boy takes the quarters and leaves. "What did I tell you?" said the barber. "That kid never learns!"

Later, when the customer leaves, he sees the same boy coming out of the ice cream parlour.

"Hey, son! May I ask you a question? Why did you take the quarters instead of the dollar bill?"

The boy licked his cone and replied: "Because the day I take the dollar the game is over!"

I possess a device, in my pocket, that is capable of accessing the entirety of information known to man. I use it to look at pictures of cats and get into arguments with strangers.

One day a father on his way home suddenly remembers that it's his daughter's birthday. He pulls over to a toy shop and asks the salesperson, 'How much for one of those Barbies in the display window?'

The salesperson answers, 'Which one do you mean, Sir? We have: Work Out Barbie for \$19.95, Shopping Barbie for \$19.95, Beach Barbie for \$19.95, Disco Barbie for \$19.95, Ballerina Barbie for \$19.95, Astronaut Barbie for \$19.95, Skater Barbie for \$19.95, and Divorced Barbie for \$265.95'. The amazed father replies, 'Why is the Divorced Barbie \$265.95 and the others only \$19.95?'

The salesperson answers: 'The Divorced Barbie comes with Ken's car, Ken's house, Ken's boat, Ken's furniture, Ken's Meccano and one of Ken's friends.'

An old man is running a fruit stand and displays a sign that reads 1 melon for \$3, 3 melons for \$10. A young man approaches and asks for one melon, for which he pays \$3. He proceeds to purchase a second, and then a third, each for \$3. As the young man walks away, he calls out, "Hey old man, I just bought 3 melons for \$9. Maybe you're not so good at this business thing." The old man mutters to himself, "Almost everyone who comes to my stand buys 3 melons instead of 1, but they all want to teach me how to do business".

Reaching the end of a job interview, the HR manager asked the young engineer fresh out of university, "And what starting salary were you looking for?" The engineer said, "In the neighbourhood of \$100,000 a year, depending on the benefits package." The HR Manager said, "Well, what would you say to a package of \$200,000 a year, 5 weeks of vacation, 14 paid holidays, full medical and dental, company matching retirement fund to 50% of salary and a company car leased every 2 years – say, a Mercedes?" The engineer sat up straight and said, "Wow!!! Are you joking?" And the HR Manager said, "Of course ...but you started it."

**Well? Was it worth the price of a cup of coffee?**

Buy me a coffee



Look. You had 5 contrates, right? Your friend Ralph comes over, stays a while, then leaves. Now you have 4 contrates, right? ...you don't have to be a Lassie to figure this one out.

A Roman walks into a bar, sticks two fingers up to the barman and says, "Five beers please."

Meccgear Jeff Clark New Zealand [sales@meccgear.co.nz](mailto:sales@meccgear.co.nz) No website yet but a pricelist with photos can be downloaded here <http://www.nzmeccano.com/image-151916> Bespoke parts from Corlust Meccano Club Ian Wilson [bespokecraftshack@gmail.com](mailto:bespokecraftshack@gmail.com) Mike Rhoades. Link to price list below. <https://www.nzmeccano.com/image-165106>