

**SHEFFIELD MECCANO GUILD**

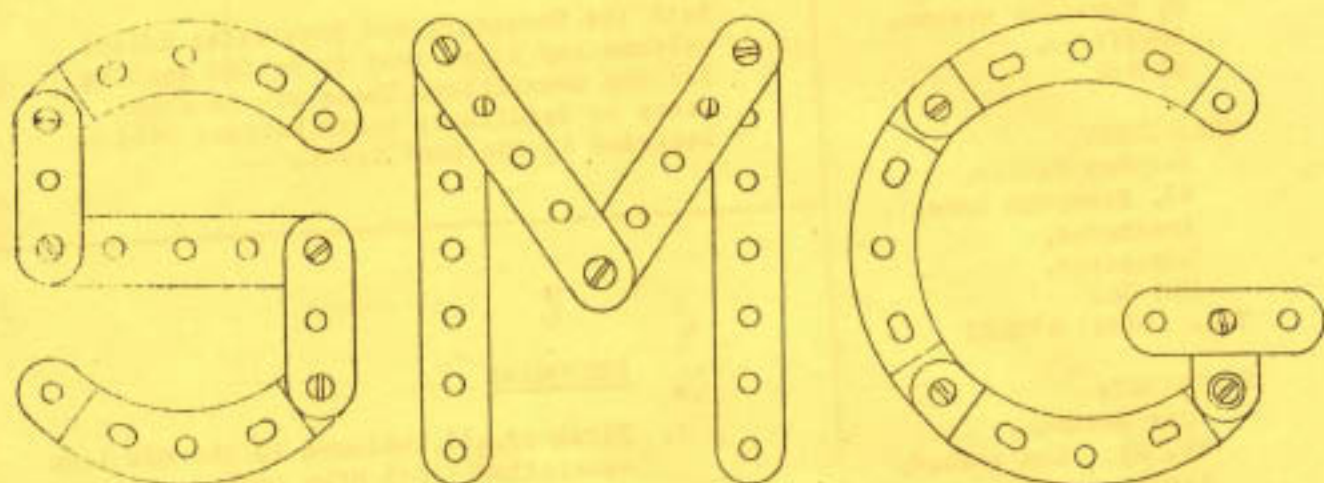

**-NEWS-**

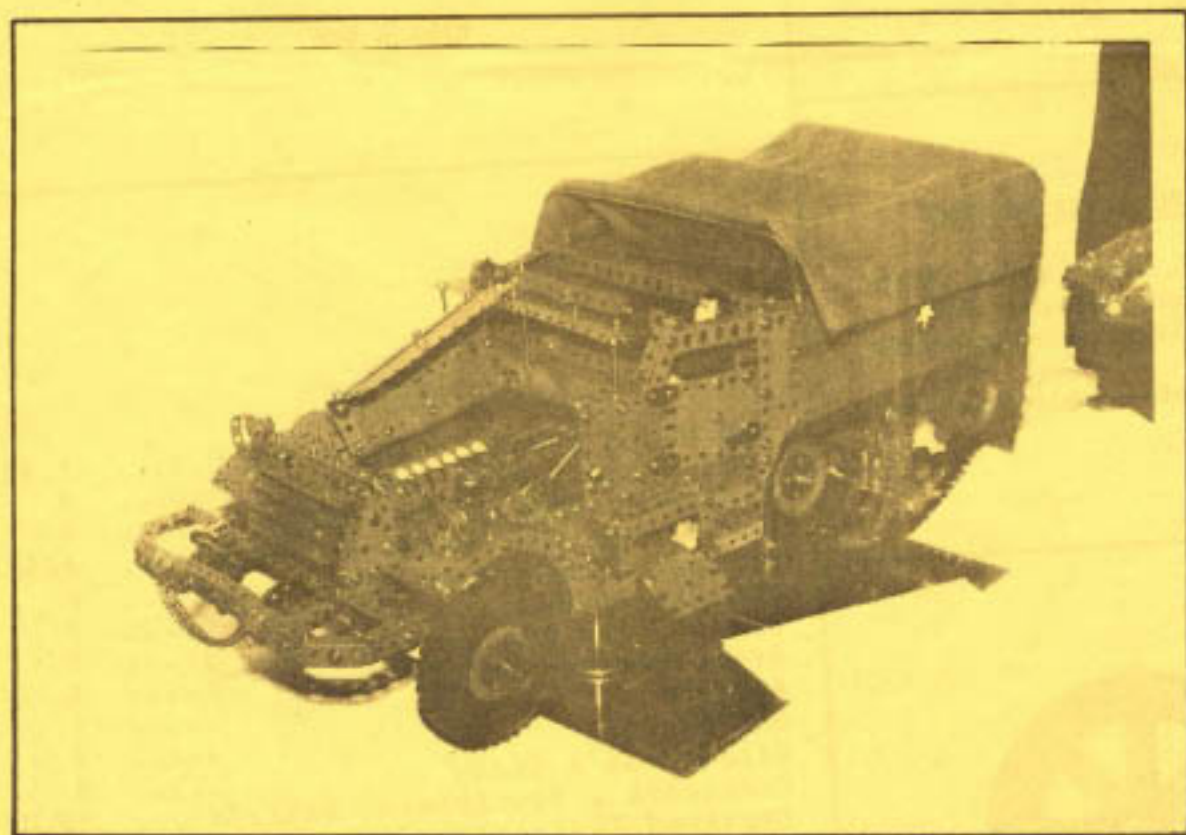

**No. 31**

**September 1990**

THE SHEFFIELD  
MECCANO GUILD

CHAIRMAN:

Charles Hatfield,

TREASURER:

Stephen Parkin,

SECRETARY:

Mike Beadman,

NEWSLETTER EDITOR:

Rob Mitchell,

SMG News is produced quarterly by the Sheffield Meccano Guild in March, June, September, and December of each year.

Both the Secretary and Newsletter Editor welcome any items sent in by SMG members for the newsletter. There are no copy dates or deadlines; contributions will be included in the next issue.

EDITORIAL

First of all, welcome to the new look newsletter! Both Mike and myself thought that it was time for a change, as we were becoming aware that SMG News no. 'x' looked very much like SMG News no. 'y'. Most of the changes have been implemented at very small extra cost, so please do not worry about increased membership costs. Once again, we have a fairly full issue, but we cannot guarantee this to always be so. Please send in your contributions; every little bit counts!

Mike & Rob

FRONT COVER PICTURE

U.S. Army 'White' Half-Track, designed and built by John MacDonald

(Photo- Robin Schoolar)

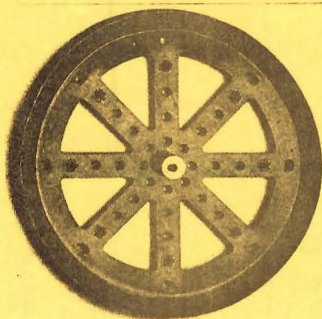

CONTENTS

SMG Model Report, August 4th. ....	1, 2&3
1929 Steam Engine Manual .....	3
Midsummer Madness Exhibition .....	4
Meccano in the 'Model Engineer'....	4&5
Norfolk Broads Weed Cutting Boat ..	6
SMG Millipede .....	7
New 'Action Engineering' Rams .....	7
Steam Powered Models .....	8
Adverts .....	9
SMG Badges .....	9
Meccanoman's Diary .....	9
Research & Development Vehicle ...	10, 11, 12
Improved Photograph Copying .....	12
Eureka! .....	12
Memories of Henley .....	13
BRAL System .....	14&15
Hydro Action Hydraulic System .....	16&17
Ilkley Show .....	18

\*\*\*\*\*

Norton Church Hall, 4th. August 1990

Attendance by modellers for this meeting on this new date was somewhat thin to say the least; probably a mixture of hot weather, industrial shutdowns and holidays took their toll. As a result, another August meeting may well be reviewed at the AGM in October. Nevertheless, the meeting was not a overall failure as the attendees were able to concentrate on each others models to a greater degree.

Geoff 'Nickel' Thompson (his own words!) arrived with three vintage SML models in - you've guessed it - nickel Meccano. His Motor Chassis and Motorcycle & Sidecar were accompanied by the SML that never was, the Aeroscope (the SML that mutated into a Mobile Crane at the printing stage). Geoff had modified this model from the original and had installed a GRB in place of the built-up roller bearing.

John MacDonald brought just a pair of his superbly constructed models; his Auto Union Racing Car of 1938 and a Tank Transporter complete with tank. Both models had the usual complete MacDonald treatment - gearboxes, differentials, full suspension, clutches, steering, etc., etc., and the tank was fitted with a rotating turret and elevating gun.

Michael Whiting brought his own incredible mechanical planetary system and a visual illusion. The Martian Orrery used shift values (NEWSMAG, July 1990) to obtain epicyclic gear trains with an accuracy of better than 0.01%. The visual illusion utilised various black segments on rotating white discs to generate different colours which were dependent on both the speed of rotation and angle of lighting.

Ernest Platts continuing interest in mining machinery has led him to construct a model of a Meco-Moore Coal Cutter & Loader of about 1940. It sported a bottom loading face conveyor and a gate road stage loader plate conveyor (a what?!). Built out of red & green Meccano, it used yellow parts where the real machine was dangerous, and the whole model was mounted on a representation of a coal face being cut and loaded.

Rob Mitchell brought four small models; the 'Steampillar', an intermittent mechanism motion with a differential, a 'Hydraulic Engine' and a souped up stick insect. The 'Hydraulic Engine' used the Action Engineering rams, arranged as a three cylinder vertical steam engine, but was not operational due to timing problems with the valves. The stick insect had a powerful '3-80' motor installed in anticipation of the SMG Millipede, more of which later.

Geoff Bennett arrived with a duo of models; a 2CV chassis and a paper folding machine. The chassis had authentic squidgy suspension and four internal expanding brakes. Geoff constructed the model from instructions in a French 'MM' of July 1956. The paper folder was 'Model of the Month' in the January 1962 'MM', and it proved to be a little temperamental at Norton!

Roy Everitt came with a Travelling Gantry Crane in yellow and zinc parts. He has appended a fuller description to his model report form, so over to his own words. "A compound girder spanning two open webbed supporting towers is built up from standard braced girders secured to angle girders on the upper and lower edges. The two supporting towers consist of 12½" braced angle girders, measuring 7½" at the base and 3½" at the top. The model is powered by two 12V, 6-ratio DC motors. One motor, housed in one of the supporting towers operates the travelling carriage. The second motor drives the moving trolley on top of the compound girder and controls the travelling and hoisting mechanisms."

Russell Carr brought his Scorpion ('again', he writes), and an unmotorised Stick insect for the SMG Millipede. He also had a part built car transporter in dark blue and yellow parts. Up to now, it consists of the trailer frame and the top deck with a sliding extension. The trailer frame is built onto a pair of hump-backed, converging, varying depth 'I' sections (wow!!), with simulated air suspension, running on 'tyred' 2" pulleys as road wheels. The wheels have/will have internal expanding brakes. The whole model is being built to 1:10 scale; watch out for this model when it is complete!

Joyce Schoolar's appropriately titled diorama 'A Summer's Theme' consisted of lots of formed curved strips made up into garden chairs, a table and a sunshade. These were accompanied by a lounge, swinging seat & sunshade, and a swimming pool floored with blue/gold plates.

John Martin's model to both railway enthusiasts and Meccano nuts (the model report writer included). It was a GNR Steam Railmotor, a predecessor of the more modern (and much less attractive) DMU's and Sprinters. The loco portion is constructed from green and nickel parts, with a red & dark blue coach, all mounted on a blue/gold plinth, to 1:23 scale. "It appealed to my sense of humour" writes John. How about a L&Y Railcar next, John?

John 'plastic Meccano' Bader brought along a plastic supermodel- a four foot high Eiffel Tower using (quote) 'millions of nuts and bolts' (unquote) and sporting a pair of lifts operated from a compact (:) plastic Meccano gearbox. John also had his 0-4-0 locomotive mounted on it's novel rolling rail constructed from the real stuff.

Charles Hatfield arrived with his own Meccano show. He had:- his cylinder printing press, a printers guillotine, a beam engine, his Burgh Island Sea Tractor, his 1904 Rolls Royce (now with the 'mechanicals' installed), a home-brewed GRB, and an Autoflex belt tensioner! They were all constructed out of red, yellow and blue Meccano with the usual sprinkling of home-made parts.

Frank Grant's pair of models were a Foster LR Class road locomotive and a Crane Kit motor powered Acrobatic Motorcyclist from a 'MM', both in red and green parts.

Hellmuth Kohler's trio of models generated much interest and discussion. All were very unique or unusual in some way. Firstly, he had a model of a Genoa Harbour Hydraulic Crane which made extremely effective use of the Hydro-Action hydraulic components to operate the hoisting and slewing motions. Hoisting was achieved by effectively reeving cord around pulleys at both ends of a ram in such a way as to magnify the ram movement, in a similar method to the SML Hydraulic Crane (!) and the warehouse lift mechanisms of Meccano models of old. Slewing was done by a pair of rams in the crane base paying out and receiving a sprocket chain which was wrapped around a drum attached to the rotating superstructure. The slewing mechanism is mounted in the crane itself on the original, but is fitted inside the base on the model so as to do away with the hydraulic slip rings which the prototype had.

Hellmuth also had a demonstration model of an orbital internal gearbox, where an eccentrically mounted gear ring rotated around a 57-tooth gear, meshing with its internal teeth and imparting an opposite rotation to the gear. All very clever stuff, but the icing on Hellmuth's cake was his highly original model of a Norfolk Broads Weed Cutting Boat, a picture of which appears on page 6, along with Hellmuth's own note on both the prototype and model. Driven by a clockwork motor, it featured a pair of front-mounted paddles which pulled the machine along and are held on the end of a movable arm so that the boat could be steered. The cutting arms-sporting rack strip blades- were reciprocated by a genuine all-Meccano swash plate (a disc mounted centrally but at an angle to it's axle) made up from a pair of wheel discs. From your reviewer's point of view, if there was to be a 'Model of the Meeting', then this would be it!

Refreshments were organised by the SMG treasurer, Stephen Parkin, and his wife; thanks are due for the marathon bread-buttering and coffee-making session.

Finally, it was hoped that the SMG Millipede (see last issue) would be created on the day. Only three units appeared- Russell Carr's, Mike Beadman's, (on holiday at the time), and Rob Mitchells. The three units ran after a fashion, but different leg lengths and driveshaft height variations proved troublesome. Hopefully, the SMG Millipede may well make a comeback at the October 20th. meeting, with the three existing units staying together until then. More details appear elsewhere.

#### NULLUS RESPONDUS!

Up to now there has been a zero response to the advert in SMG News no.30 about the copy of the 1929 Steam Engine Manual. As a result, the scheme is to be repeated, with an extended 'deadline' for interested members. For those who do not have issue no.30 to hand, here is the item again.....

#### 1929 STEAM ENGINE MANUAL

During recent correspondence with Ernest Palmer, Ernest has sent to the SMG a photocopy of his own 1929 Steam Engine Manual. A photocopy of this was made, and it is intended that this second copy can be circulated among any SMG members who may be interested in seeing it. Circulation to interested enthusiasts would be by post, with one member passing it on to the next on the enclosed list- an identical system that the NMMG uses for passing on it's Skegex videos. Any members who would like to see it should send their name and address to Rob Mitchell, address inside front cover. Please respond by the end of November 1990; the postal list will be on a 'first come first served' basis.

MIDSUMMER MADNESS MECCANO EXHIBITION

-submitted by JOHN BADER (BRADFORD)

This event took place during the afternoon of June 23rd., as part of Bradford's Hollingwood Lane School's annual gala. Eight exhibitors brought 24 working models.

Alan Grimshaw brought seven red and green models including his Penguin Staircase and two small Meccanographs which proved very popular with the children.

Roger Burton, another red and green man, brought four models. His 1930's Aeroplane Outfit Monoplane was mounted on a base equipped with a press button to operate the propellor.

Brian Harper and family brought their Automated Obstacle Railway on which the 'Little Joe' engine negotiated various hazards all afternoon. This model needed six tables!

Ian Storey of Bradford came along with the Modelplan Ball Bouncer, the 1970's M.M. Diabolic Money Grabber, and the 'Ding Ding Tramcar' from the old M.M.Q., although this is presently a static model as Ian needs some 'O' gauge 2' radius curves.

Russell Carr came from Wakefield with the Set 5 Scorpion which actually works due to it's internal reorganisation.

York enthusiast Paul Smith, who has only recently re-started his Meccano activities, had built the Liverpool Supermodel Railway Breakdown Crane in red and green.

Pete Pyefinch staggered in with his Kenworth conventional Tractor Unit. A photo of the original model appeared in 'Newsmag' several issues ago. Pete had also built a very realistic tri-axle tilt trailer sporting the Meccano logo to sit behind it.

Lastly, the organiser, John Bader, displayed all of his current models, including the recently completed C.Q. 'Skaters'. This was quite popular with the children as current to the motor was supplied by the discontinued Hand Generator.

The school's parent's association wishes to thank all of the exhibitors for the splendid display of models. A donations box placed near the classroom door raised a tidy sum towards school funds.

(Ed.--thanks to John for the above model report. If you are organising any similar 'do's', please don't hesitate to send in a post mortem! Writing model reports is not too difficult, so long as you have plenty of alternative words for 'brought', 'fetched' and 'landed with'!!)

MECCANO IN THE 'MODEL ENGINEER'

No doubt that many SMG members take the 'Model Engineer' on a regular basis, and that they will have seen the article by Ernest Palmer which is reproduced opposite. The article is self-explanatory, but spot the deliberate spelling mistake! Thanks to both Frank Singleton for sending in the article, and Mr. Ted Jolliffe of the 'Model Engineer' for allowing the article to be reproduced.

# MECCANO FOR MODEL ENGINEERS

## Ernest Palmer uses Meccano to make quickly build 3D models which satisfy his creative urges

Whenever I see those beautiful working steam locomotives, road rollers, traction engines and stationary engines, illustrated in *Model Engineer* I often wonder how much time it took to complete any one model.

About 1910 Mr. Rank Hornsby patented a method of building by using a set of various standard components. Meccano was originally designed, as a toy for boys to build various models from instruction manuals.

Today Meccano is used in education and is also an adult hobby and collectors' material. Some adults have accumulated large amounts of components and sets. I have more Meccano than I ever dreamed of as a youth, but even my collection is small fry compared to other exhibition model builders. I have seen photographs of a Meccano locomotive and tender over 11 ft. in length and Meccano cranes that tower to the ceiling of exhibition halls.

These are models built by private individuals, not counting the exhibition models formerly built by the model building department of Meccano Ltd., Liverpool.

The model engineer needs a small workshop and months or years of spare time to complete a model. The Meccano enthusiast needs to accumulate a large stock of Meccano and a variable amount of spare time to build a model. If the above two model makers were building approximately the same model, the Meccano enthusiast is more likely to complete his model first. As and when he feels inclined, he can then strip it down to build another model.

The Meccano enthusiast does not have to be a skilled machine operator before being a model builder. The Meccano enthusiast can decide to build a model of something he has seen, or even from a photograph or an illustration. The next decision to be made is the estimated size of the model. Take for example, the *Grasshopper* engine that appeared on the cover of *Model Engineer* recently.

I decided to use a particular Meccano plastic box for the base and the rest of the model was made proportional to that base. Another model builder might have decided to make a 20 in. flywheel as his starting point. His model would have a base built up from angle girders and plates, for the

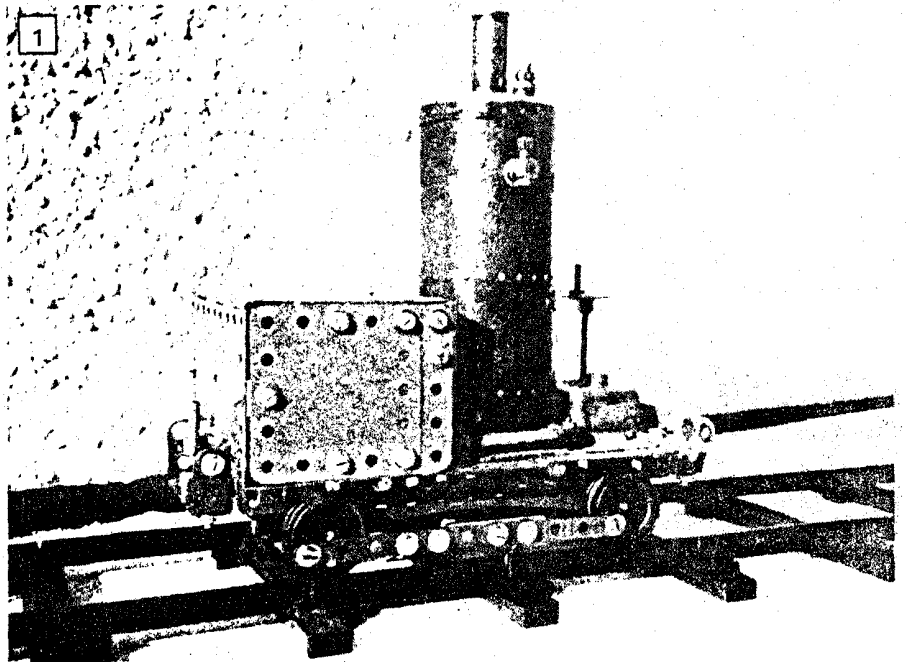

1: An example as to how Meccano can help in the visual impact of a model - first build a 3D representation, as is the case with this "Coffee Pot" locomotive.  
2: One of the two Grasshopper Beam Engines built in Meccano by the Author.

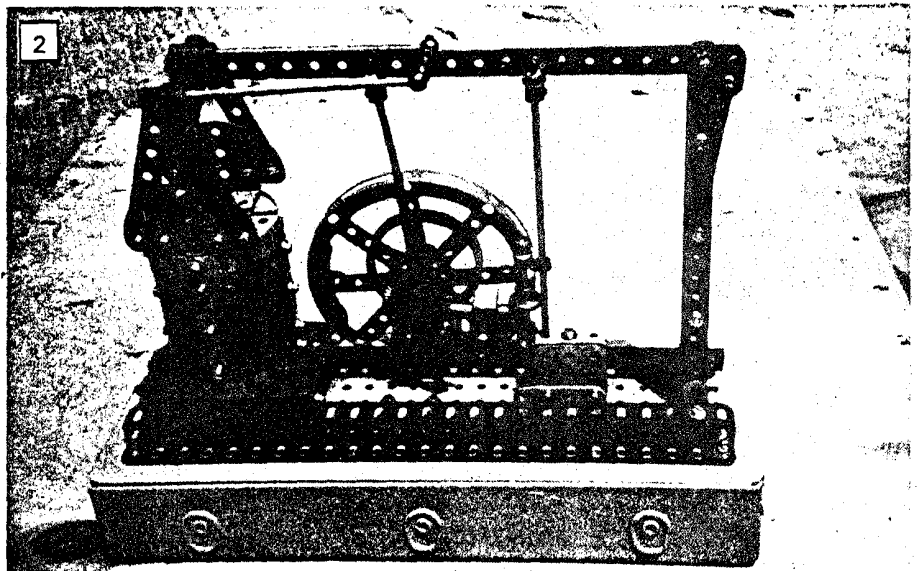

flywheel to be clear of a table top on which the model was placed. After having built my model mentioned above, for the benefit of younger modellers with a smaller collection of Meccano, I built a similar engine on a standard 5½ in. × 2½ in. flanged plate base.

The only limitation to a Meccano model is the amount of Meccano available to the model builder. Apart from the aforementioned locomotive and tender being about 11½ ft. in length, I have seen photographs

of someone else's battleship of about 12 ft. in length. Another instance was a low loader tank transporter of some considerable length.

Meccano models can be impressive for various reasons: (a) Sheer size; (b) Ingenuity; (c) Sheer simplicity.

One problem with the sheer size models is where to keep a locomotive or battleship or tank transporter when it is not at an exhibition? Hence, my models are of somewhat modest proportions. 

NORFOLK BROADS WEED CUTTING BOAT- Constructed by HELLMUTH KOHLER

This extraordinary 'boat' was seen a few years ago on a remote part of the Broads. One photograph showed a view of it in action, the other showed the 'sharp end' lifted clear of the water. Propulsion is by 'bow wheel' (as opposed to 'stern wheel') and steering is by slewing the paddle wheel to the side. The cutters reciprocate quite slowly as the boat moves forward.

The model fails to capture the lightly built look of the original, but it reproduces all motions that were seen. The swash plate drive to the drop arms which oscillate the cutters is functionally correct.

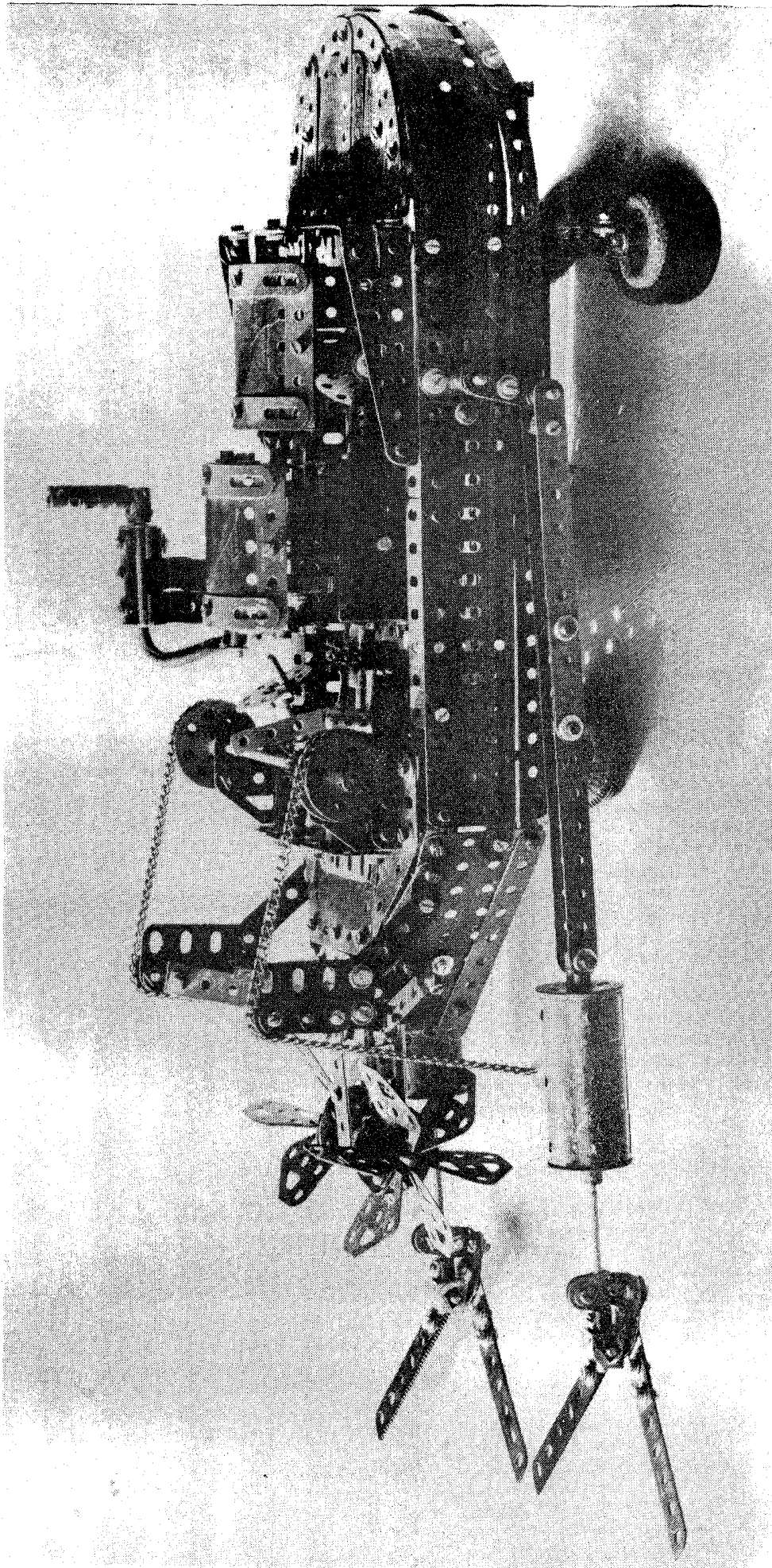



SMG MILLIPEDE

A note about this appeared in issue no. 30 of SMG News, and it suggested that a long walking machine with billions of legs could be generated by connecting up lots of 'stick insects', the construction of which is shown in CQ no.5, pages nos. 20 & 21. Interested modellers should omit the motor and its mount and replace the central driveshaft, the one with the worms, with an 8" axle rod fitted with an universal coupling at each end. In addition, secure a short rod (3" or so) in the end of the rear universal coupling. Also, replacing the 1" bush wheel driving cranks with angle brackets bolted onto collars through their slotted holes uses more common parts. Then, bring it to Norton in October!

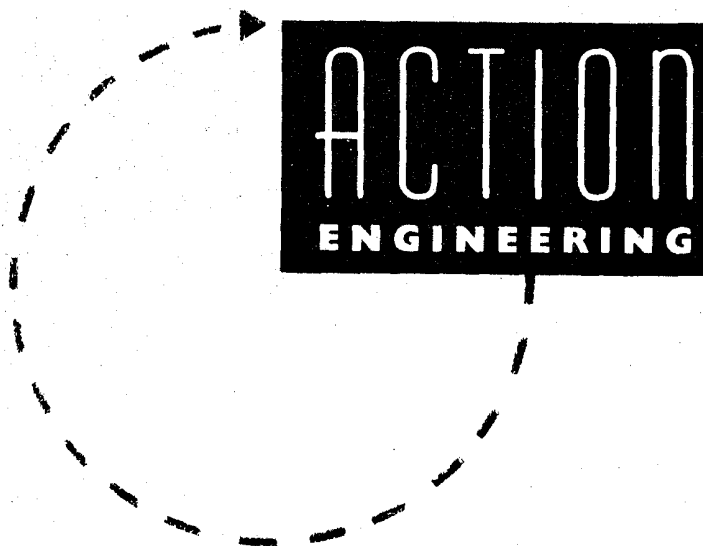
NEW ACTION ENGINEERING COMPONENTS

Many members are now familiar with the Action Engineering model Hydraulic System, and further to this we have enclosed some information, supplied by them, about their new range of smaller rams made out of mainly metal components. We would also like to add that Action Engineering have allowed the SMG to use the stamped, unaddressed envelopes that they sent to Mike Beadman to send on to the SMG membership to also contain this issue of SMG News. This has saved the SMG a not inconsiderable amount on postage; they have also sent a postal order for £5 for our efforts of sending out the information, which will go to SMG funds in due course.

The new rams are considerably smaller than the existing polycarbonate range, and they consist of a length of aluminium tube, the length of which varies for each size ram, capped with heavy duty black plastic ends. The nut on one end is nickel plated; the ram rod and clevis are well plated with chrome for a brilliant finish.

No doubt that many models will be seen in the near future, making good use of these attractive components.

A SELECTION OF STEAM POWERED MODELS- sent in by ERNEST 'STEAM ENGINE' PALMER

No.1- top right- Mamod/Meccano engine applied to SML gantry crane

No.2- bottom left- Mamod/Meccano engine built into the SML Railway Breakdown Crane

No.3- bottom right- Freelance steam tractor with a Mamod overtype engine installed

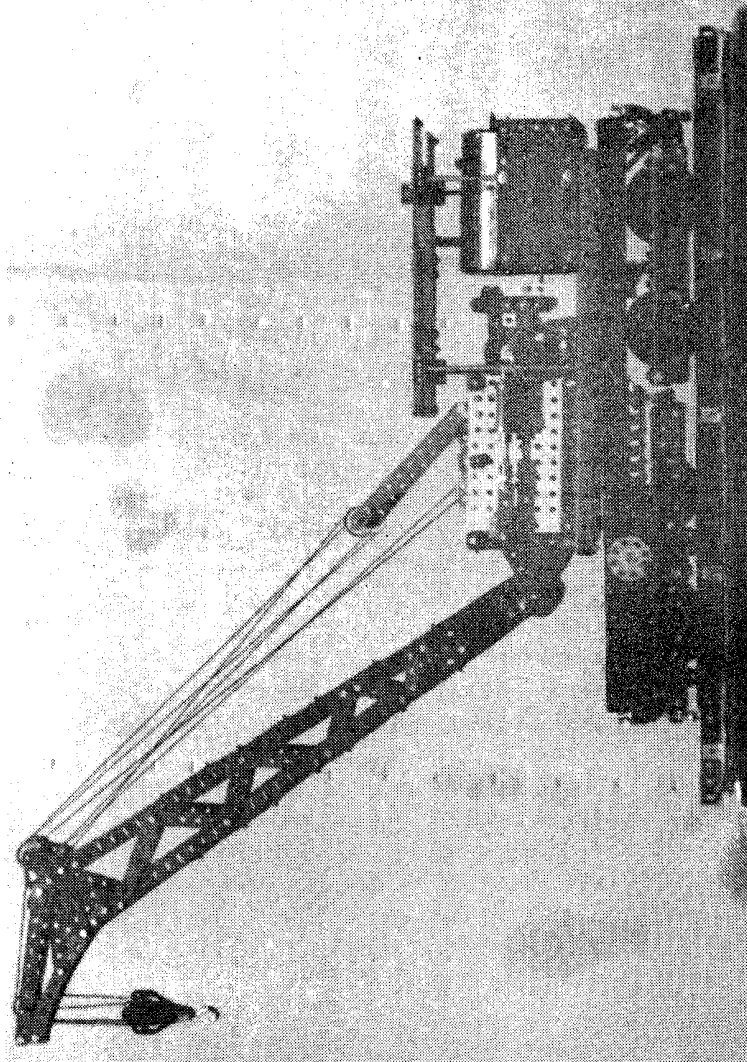
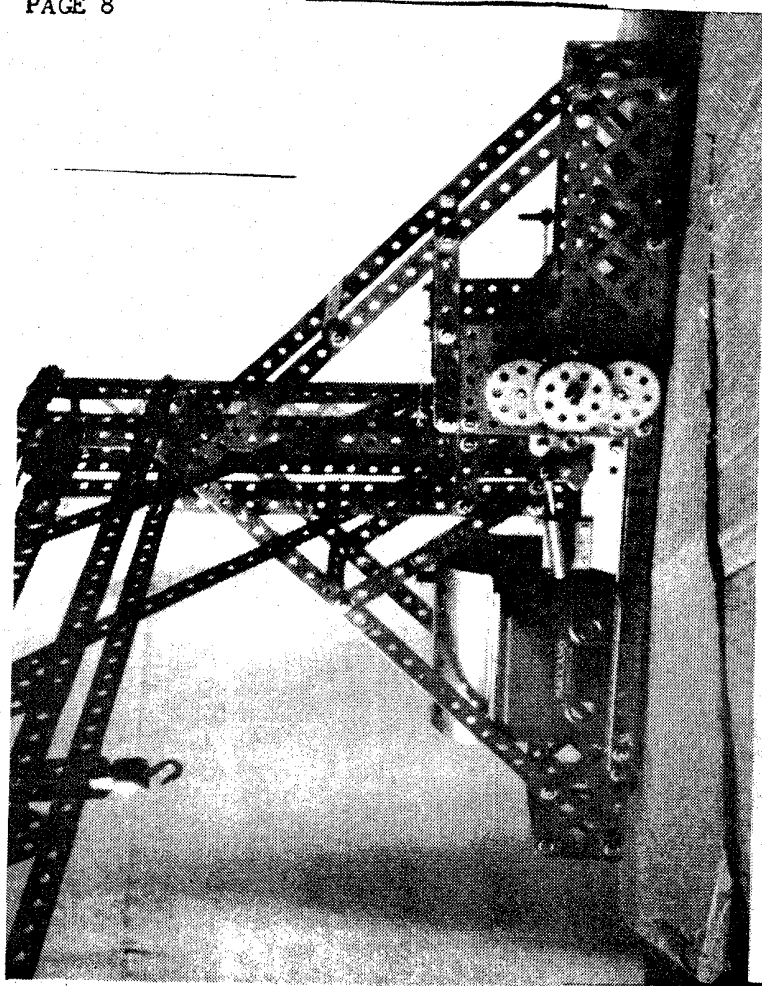

ADVERTS

The editor welcomes adverts from any members who may wish to buy or sell any Meccano or associated paraphernalia through these pages, free of charge. Please send your advert to either Mike Beadman or Rob Mitchell, addresses inside the front cover. To start the ball rolling (again!), here is one of my own which I prepared earlier:

FOR SALE-MO motor battery boxes. Red plastic mouldings to hold two 'C' size cells, complete with connecting/contact tags. 20p each. They should be available at all SMG and NMMG meetings this year. (Rob Mitchell)

SMG BADGES

The SMG has for sale a number of badges, designed by Robin Schoolar some time ago. They are about 1" diameter and have a pin on the back to put it onto your lapel or whatever, and show six 1" triangular plates arranged into a circle. No well dressed Meccanoman should be seen without one!

Prices are £1 each, but a very limited number have faulty pins, and are a mere 50p each, and are ideal for blu-tak-ing onto a prominent position on your latest creation!

Please send remittance and the total number of badges required to Rob Mitchell, address inside front cover. Please make cheques payable to the SHEFFIELD MECCANO GUILD. Oh- I forgot- please also include 20p postage per badge! Thanks.

THE MECCANOMAN'S DIARY

September 15th.-----North Midlands Meccano Guild, A.G.M. & club meeting,  
Oxton village hall  
October 6th-----Midlands Meccano Guild, club meeting, Alcester  
October 20th-----SHEFFIELD MECCANO GUILD, A.G.M. & club meeting,  
Norton church hall  
October 23rd-28th----Telford Town Centre Meccano Exhibition. Contact  
John Linder (0952) 583345(day) or 584981(evening)  
November 17th-----Darlington Meccano Exhibition, North Eastern Meccano  
Society

1991

January 26th-----North Midlands Meccano Guild, club meeting, Oxton  
village hall  
March 30th-----Midlands Meccano Guild, club meeting, Alcester

RESEARCH & DEVELOPMENT VEHICLE Mk. II

-By Ernest Palmer

The reason for the title "Research & Development Vehicle" was initially to find out how much reduction gearing was needed for the Mamod/Meccano steam engine to move it's own weight. Unlike the Binns Road 1929 Meccano steam engine, this Mamod engine does not have a 6.5:1 reduction ratio built into it. Too little reduction gearing, and the model would only just crawl along. By increasing the reduction ratio, one reaches the best combination of gears to obtain maximum speed. Any further reduction gearing, and the model becomes a tractor.

Starting with the basic engine, add the minimum of constructional weight. Two angle brackets (12) at the front of the boiler baseplate, with the slotted holes vertical, are bolted on for the front  $4\frac{1}{2}$ " axle (15a) fitted with 2" tyred wheels, (20a & 142a)-Fig.3. A  $2\frac{1}{2}$ " double angle strip (48a) is bolted to the centre hole of a  $2\frac{1}{2}$ " strip (5). This is now bolted across the baseplate immediately behind the firebox, with a couple of washers between the baseplate and the  $2\frac{1}{2}$ " strip-Fig.1. The purpose of the couple of washerson each bolt is to provide the space for the head of the bolt holding the double angle strip in a vertical position. At the top end of the  $2\frac{1}{2}$ " double angle strip is a  $5\frac{1}{2}$ " strip

FIG. 1 ENGINE BEDPLATE

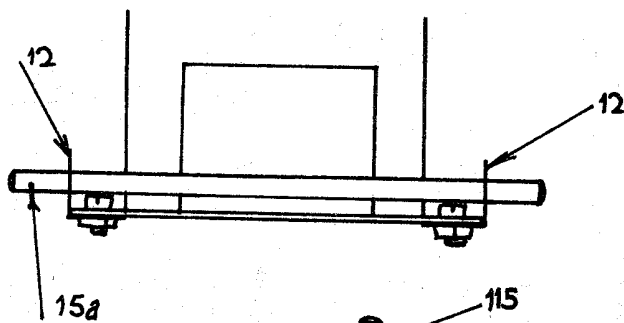
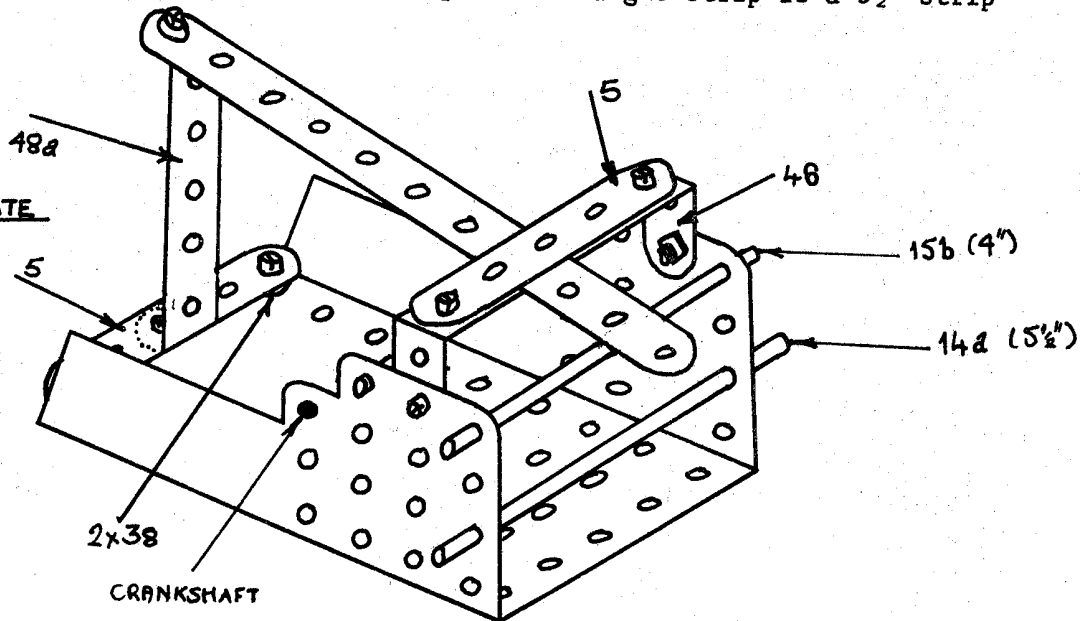

FIG. 2 FRONT AXLE MOUNTING

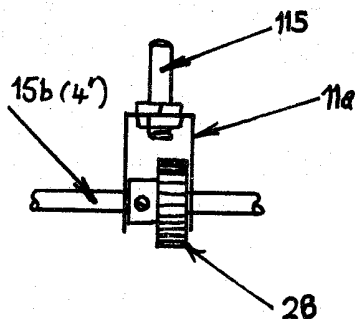

FIG. 3 GEARCHANGE

(2) which is free to move on a lock-nutted bolt; this  $5\frac{1}{2}$ " strip is going to be the gearshift lever.

Bolted across the centre top holes of the vertical plates at the end of the baseplate is a  $2\frac{1}{2}$ "x1" double angle strip (46). On top of this is bolted a  $2\frac{1}{2}$ " strip (5) with a single washer spacer on each bolt. Before fixing the second bolt or nut, put the  $5\frac{1}{2}$ " gear change lever between the other two strips. Tightening these last two bolts and nuts, with their spacing washers, forms a friction clamp for the gearchange lever. This lever has to be free enough

for the operator to change gear, but the clamp is just tight enough to keep the lever still when the model is working.

Finally we come to the reduction gearing between the vertical plates. Most engines already have a 19-tooth pinion (26) on the crankshaft. By dismantling the engine, one can now remove this pinion and replace it with a 15-tooth pinion (26c), with the boss towards the crank. Having reassembled the engine, the pinion can be temporarily left around the middle of the shaft out of the way. A 2½" axle rod (16a) in the nearest hole in the top row of holes carries a 19-tooth pinion with a ½" face and a 38-tooth (31) gear. Both have their bosses towards the vertical plates, and each has a single washer.

In the other top corner hole is a 4" axle rod (15b) which has a 57-tooth gear (27a) with a couple of washers and it's boss inside and towards the vertical plates, and a 25-tooth pinion (25) inside a double bracket (11a). The latter has a small threaded pin (115) locked in it's central hole- Fig.2. This pin protrudes through the gear change lever at the fourth hole from it's end; that is, immediately beyond the clamping strips. At the extreme ends of this 4" axle rod are a washer and 15-tooth and 19-tooth pinions with their bosses outward; that is, one pinion at each end.

One inch below the 4" axle rod is the 5½" axle rod (14a)- the rear axle rod. This rod has a 50-tooth (27) gear fixed to it's mid point, to be driven by the above 25-toothpinion. Outside of the vertical plates, two washers on each side is followed by a 60-tooth gear (27d) on one outer side, and a 57-tooth gear on the other side. These gears also have their bosses facing outwards, and these are followed by two spacing collars (59) on each side, and finally the 3" tyred wheels (19b & 142b) with their bosses inwards.

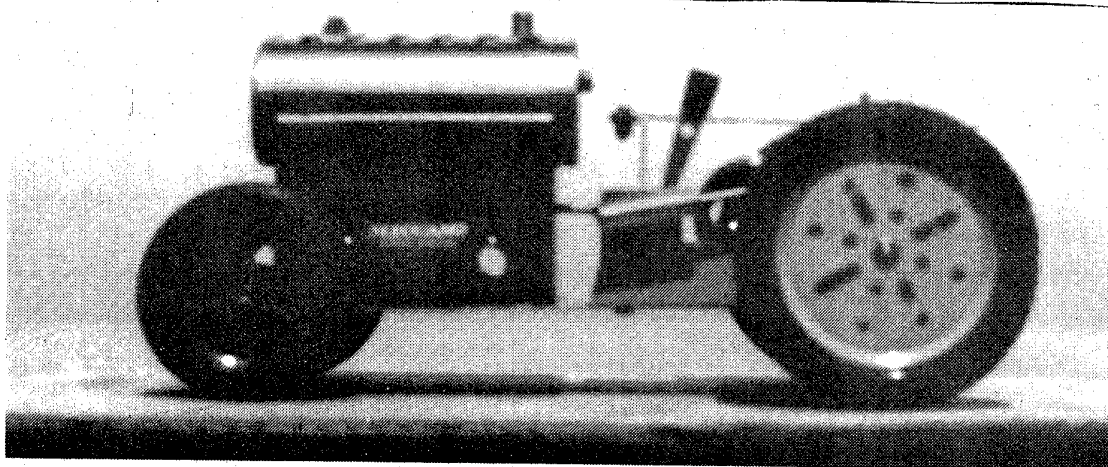

We now have the vehicle completely assembled. All that needs attention now is the minute positioning of the 25-tooth pinion and 50-tooth gear, so that when the 4" axle rod is moved from one extreme position to the other, the 50-tooth gear is out of mesh with the 25-tooth pinion. Having got the gear train and gear change working, we can now engage the 15-tooth pinion on the crankshaft with the 38-tooth gear on the 2½" axle rod.

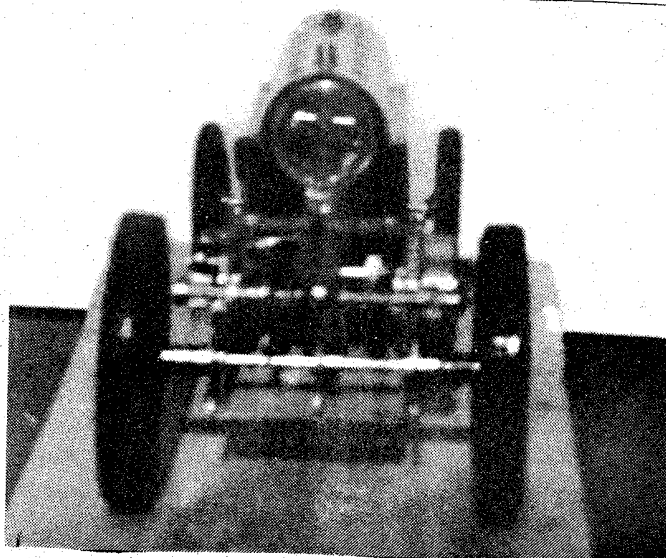

Because Meccano gears are not synchromesh gears, I do not suggest changing gear whilst the model is running, but rather like the old traction engines, stop and manually change gear, and then set in motion again. I do not approve of crunching gear changes.

RESEARCH & DEVELOPMENT VEHICLE Mk. II-- Parts List

<u>Part no.</u>	<u>Qty.</u>	<u>Part no.</u>	<u>Qty.</u>	<u>Part no.</u>	<u>Qty.</u>
2	1	20a	2	37	10
5	2	25	1	37a	1
11a	1	26	1	38	14
12	2	26a	1	46	1
14a	1	26c	2	48a	1
15a	1	27	1	59	4
15b	1	27a	2	115	1
16a	1	27d	1	142a	2
19b	2	31	1	142b	2

...and 1 Mamod/Meccano steam engine!

IMPROVED PHOTOGRAPH COPYING

Some time ago, Dave Yates of Bolsover mentioned to Mike that he had the 'paraphenalia' necessary to produce dotty half-tone prints of photographs, and that he would be happy to so process any for SMG News. Mike and myself took him up on his kind offer, and virtually deluged Dave with black & white photographs! The fruits of Dave's labour are scattered throughout this issue of SMG News, and the superior copying characteristics will be readily appreciated. We have in store several more half-tones for future issues of both recent and not so recent models, taken mainly by Robin Scholar, so your model may feature on the cover at some time!

**EUREKA**

Note; Tim Caulton was the Outservices Manager for Kelham Island Industrial Museum until recently, and gave the Guild lots of help and advice for our exhibitions. He has now moved on as detailed in the following transcript of a letter to Mike Beadman.

'Many thanks for your kind note of the 12th July. I thought I ought to let you know where I've gone- I started this week as 'Education and Interpretation Manager' at EUREKA, the new children's museum opening in Halifax in Spring 1992. It is a very exciting project, and although I've had eight and a half very happy years at Kelham, I was ready for a new challenge.

No doubt I'll see you at Christmas at Kelham!'

MEMORIES OF HENLEY

By Richard Bingham

I arrived for the exhibition on the afternoon of Thursday, August 30th, to see the inviting looking Meccano signs on the Town Hall. Inside, preparations for the weekend were being completed by Bob Ford, Tony Knowles, and other members of the Henley society of Meccano Engineers.

Upstairs, in the main hall, I placed my clock alongside John Bader's display of models which included an unusual large Eiffel Tower with working lifts, in Plastic Meccano.

On my way to the basement, (to sort out accommodation with the Tourist Office), I noticed members of the MMG setting up their display in the lower hall. In the basement, for the first time, John Linder and Mike Rhoades had their sales stalls, well stocked and with presentation to a high standard.

Friday- by lunchtime the whole Town Hall was filled with Meccano models. There were far too many to mention here, but certain models particularly caught my attention. In the lower hall, was Tony Rednall's Designing Machine, which won the Issigonis Shield at Skegness. Tony also showed his articulated Loading Shovel with the superb Diesel sound effect.

Geoff Pratt brought his Supermodel Dragline, while Michael Edwardes' Live Steam Tram and Trailer ran on a track the full width of the hall. The long stretch of tables by the door was completely filled by John Macdonald's vehicle models, including his splendid new American Heavy Breakdown Truck.

Upstairs, Iain and Barrie Mackenzie joined us with their Supermodel Dredger, while Reg Hall occupied the space at the top of the main stairs with his Yarn Twister and display of jumpers which he was raffling in aid of his favourite charity.

It was a real joy to tour the hall and view the displays at my leisure- before the expected crowds of the public opening day on Saturday. It was the best show at Henley of recent years, with a sheer quantity of models never seen before.

Saturday- due to radio and TV coverage of the exhibition, and good weather, the hall became very crowded, with queues forming down the main street!

At 5:30, the first meeting of the International Society of Meccanomen was held, introduced by Michael Adler, who explained the aims and ambitions of the Society, in order to form a worldwide fellowship of Meccano enthusiasts.

The committee of the ISM consists of; Michael Adler (Israel), Peter Kessler (Germany), Alan Partridge, Paul Joachim, and John Westwood, who produces "The International Meccanoman".

Geoff Wright acts as consultant to the ISM, and also gave permission to use the term "Meccanoman", of which he owns the copyright.

BRAL SYSTEM

Some time ago, an appeal went out in SMG NEWS for information about the Italian BRAL construction system, which has remarkable similarities to Meccano. Thanks to Roland Piazzoli, who put on such a fine display at SKEGEX with his BRAL Alfa Romeo, we can reproduce at least in part a poster style leaflet detailing the BRAL range.

The range of sets consists of two types: BRAL 'system' of sets numbered 2-9 containing standard parts, 2-6 inclusive being packed in cardboard boxes, 7-9 in wooden boxes containing compartmentalised trays. The BRAL 'Kit' series is intended to make one particular model per set- Motorcycle, Breakdown Lorry, Helicopter etc. Some of the 'Kit' sets have special parts such as plastic floats for the helicopter, and it is perhaps noteworthy that every model illustrated in the leaflet is a vehicle of some kind. Also, the models shown are thin on moving parts, no motor being supplied with any of the smaller sets. A scant mention is made that sets 7-9 have a motor, but no details are supplied. It would seem to be some form of sideplate motor.

Standard colours are blue for metal plates, red for plastic, and strips are plated. I understand hole spacing is standard Meccano, but no information about gear compatibility is available. The parts list is quite extensive, including such oddities as a very Meccanoesque Circular Saw, but there are no large circular parts, and no helical gears, nor Meccano/Marklin type universal Gear.

BRAL is so very similar to Meccano that choice between the two would be largely a matter of price. BRAL has nothing that Meccano lacks as far as one can see from the leaflet, but judging by what Rolando shows at SKEGEX, it is an acceptably complete and competent constructional system.

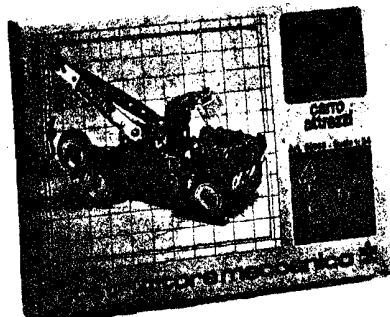
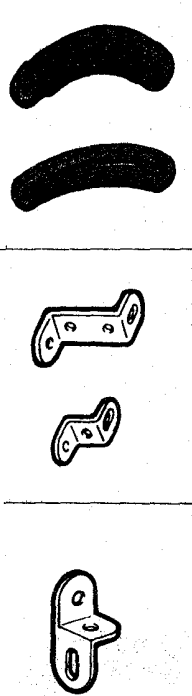

**KTA 90056**  
355x270x50 mm. - Kg. 0.500



**KTS 90055**  
355x270x50 mm. - Kg. 0.400



**KTX 90050**  
395x315x50 mm. - Kg. 0.500





# bral

il costruttore meccanico

## «BRAL CONSTRUCTION SET»



The new line of Bral Construction Sets is the most interesting construction system now in existence. Its multiple, precision-made components represent genuine miniature engineering. It's the only set that allows the models built to be utilized and motorized, and it will pleasantly and effectively introduce kids to the wonderful world of mechanical engineering.

The line comprises 9 sets - from No. 1 through No. 5 in cardboard boxes and from No. 6 through No. 9 in wooden cases.

To implement this construction system there is the "Electro Bral" set, whose elements complete and amplify its applications.

Strisce a doppio foro			
3170	mm 60	fori 5	6
3171	mm 75	fori 6	
3172	mm 90	fori 7	
3173	mm 140	fori 11	
3174	mm 240	fori 19	
3175	mm 320	fori 25	

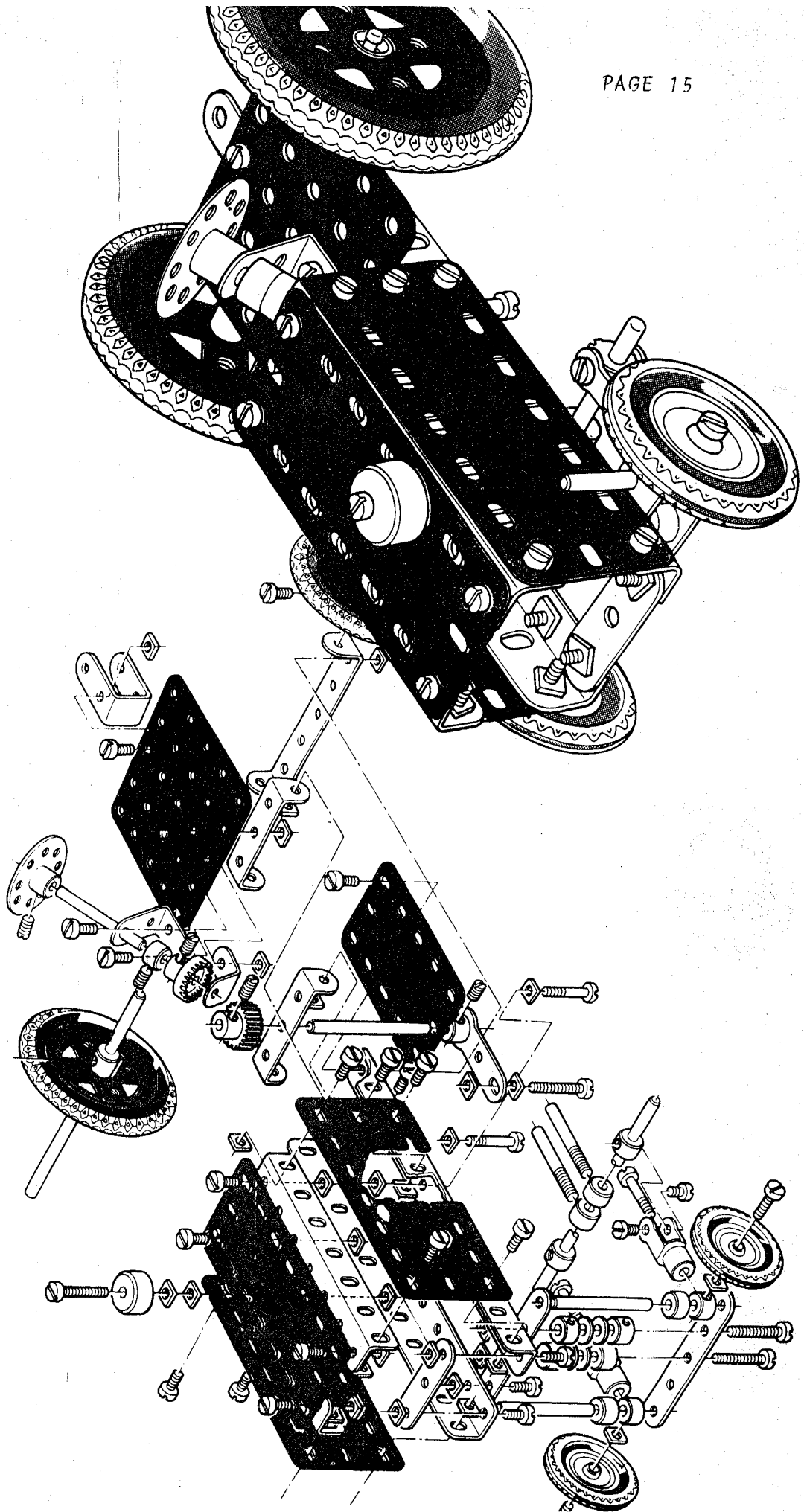

il costruttore meccanico

HYDRO-ACTION MODEL HYDRAULIC SYSTEMTest Report

SMG MEMBERS may by now have had an opportunity to examine at close quarters this hydraulic system produced in Sheffield. The company have displayed working models at Kelham Island and SKEGEX, where also to be seen were the sets now on sale to the general public.

So far as the Newsletter team are aware, SMG NEWS is the first Meccano publication to report on construction and use of the system.

The Set

As tested, the standard set comprises three cylinder assemblies, three Spool Valve assemblies, a Tank Reservoir, Pressure Relief and Non-return Valves, a Motor/Pump unit, a filter, and set of hose connectors. Also included are mounting discs and clevises for the Cylinders, connecting tube, and a Spanner.

The instruction manual and parts price list are a bit basic in appearance, produced on a word processor- but are clear and easy to follow. The set is well presented in a tasteful grey cardboard box with full colour pictures of possible applications for the set on the lid. It is notable that the Meccano models shown are of typical mid-set type, perhaps intended to suggest that it is not necessary to have a lot of Meccano to use with the Hydro-Action.

The parts are contained in moulded plastic trays finished in a pleasing purple 'velvet', with the tubing underneath, and small components in plastic bags in the reservoir.

Apart from the obvious need of a suitable Meccano model, or indeed other constructional system, further requirements are a power supply, such as a 12V DC 1A transformer, and a sharp Stanley knife.

Hydraulic system Assembly

Although, as stated in the manual, you should read all the manual before assembly of components, the 'nitty-gritty' of the book is in the sections 'Circuit design' and 'Circuit Assembly.' Once you have understood what a hydraulic system is for and what it will do, the first step is to put together a working circuit.

The 'Circuit Design' section explains the symbols used for components in the circuit diagrams; the appearance of the circuits shown bears a marked similarity to wiring diagrams. To accompany the suggested first circuit is a detailed step-by step 'Circuit Assembly' section, which, if followed, will produce a system to operate one cylinder. For the purpose of this test a twin cylinder circuit was produced, such as would be required for a skip lorry model.

The only part worthy of criticism in the whole set was the first required- the pump mounting bracket, which was a tacky piece of plastic. Doubtless many modellers will be able to make something better, but the bracket as supplied does the job.

The rest of the circuit went together easily, the 3mm internal dia, piping being tight enough to provide a secure fit without resorting to any clips or clamps. It is indeed noted in the manual that the

only recommended way of removing a pipe from a component spigot is by cutting the tube lengthways with a Stanley knife. Pulling the pipe off may break the spigot. It is not that the spigots are weak, but the pipe fits very well onto the ridged spigots.

Once the system is assembled, the impression is that of some kind of medical equipment! This is probably due to the fact that nearly every component is transparent, and this is possibly not to everyone's taste. One remedy may be to use coloured water- food dye-, but in the opinion of the tester, the manufacturers should give some thought to producing the cylinders in coloured plastic, or supply a sheet of decorative transfers.

### System operation

Nowhere in the manual does it say what current is consumed by the pump motor. For its first run, therefore, the system was connected to a car battery charger capable of supplying 4 amps. With the reservoir threequarters full of water, and the pump primed as instructed, when the power was switched on the pump roared lustily, filled the system within five seconds, and soon afterwards the pressure gauge showed a remarkable 45 PSI/3 Bar. The pump was quickly switched off as two substantial leaks were noticed, one from the pressure gauge spigot, one from the non-return valve seal. The valve was settled with a smear of Vaseline on the seal, but the pressure gauge spigot, a substantial metal object, forms a metal-metal contact onto the gauge via a brass thread, and needs tightening hard. Once this was done, no further trouble was encountered.

Operation of the control valve, once the leaks had settled, produced a smooth operation of the cylinder with sufficient power to give the tester quite a surprise when he tried to stop it with his hand! Travelling at about an inch a second, the piston will clearly move a considerable load. I eagerly await an actual power figure in terms of foot/pounds from someone more knowledgeable in these matters.

### Summary

Hydro Action works well, and is powerful. It is also very interesting, and educational. It is not cheap, the set on test currently costs around £90, but it is a quality product for which a complete range of spares and extras are available, and it is very difficult to produce a strong and reliable imitation hydraulic ram in Meccano. The main advantage of a hydraulic ram for a modeller is that it is connected to its power source only by flexible pipes, making installation much less of a problem.

I predict that many modellers will welcome Hydro-Action since it opens up new possibilities in conjunction with Meccano.

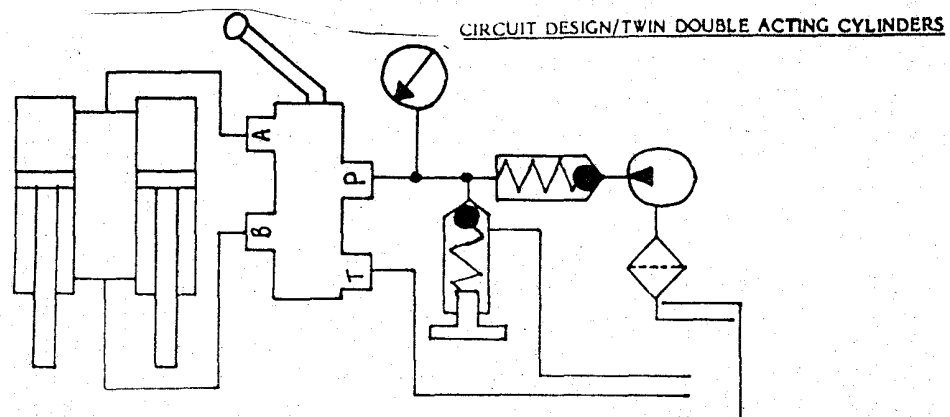

Typical circuit diagram from the Hydro-Action manual.

ILKLEY SHOW- report from Alan Grimshaw

Meccano was again on show at Ilkley this year in the 'Winter Gardens' at the Lionel Collectors Club UK get together.

I was helped by the following members and we easily filled forty eight feet of tables.

John Bader

Automatic Meccanograph (design by Dr. I.A.H. Boerdijk)  
Nickel Ferris Wheel  
0-4-0 Loco and Tender on 'rolling rail'  
Showman's Traction Engine (from may '65 MM)  
Plastic Meccano Dockside Crane  
Handiman Access Platform (Design by Robin Schoolar)  
Army Multikit Half Track (built by son Jonathan)

Wayne Stancliffe

Railway Breakdown Crane  
Norton Motorcycle and Sidecar (Design by Andreas Konkoly)

Richard Bingham

Synchronous Clock

Geoff Tomlinson

Two Showman's Traction Engines one to 2" scale, one to 1½" scale  
Motor Car Chassis  
Motor Cycle and Sidecar

Alan Grimshaw

Coalwagon Tippler  
American Loco and Tender  
16 horse Galloping Roundabout  
Penguin Slide  
Small Beam Engine  
Two small Meccanographs

