

SHEFFIELD MECCANO GUILD

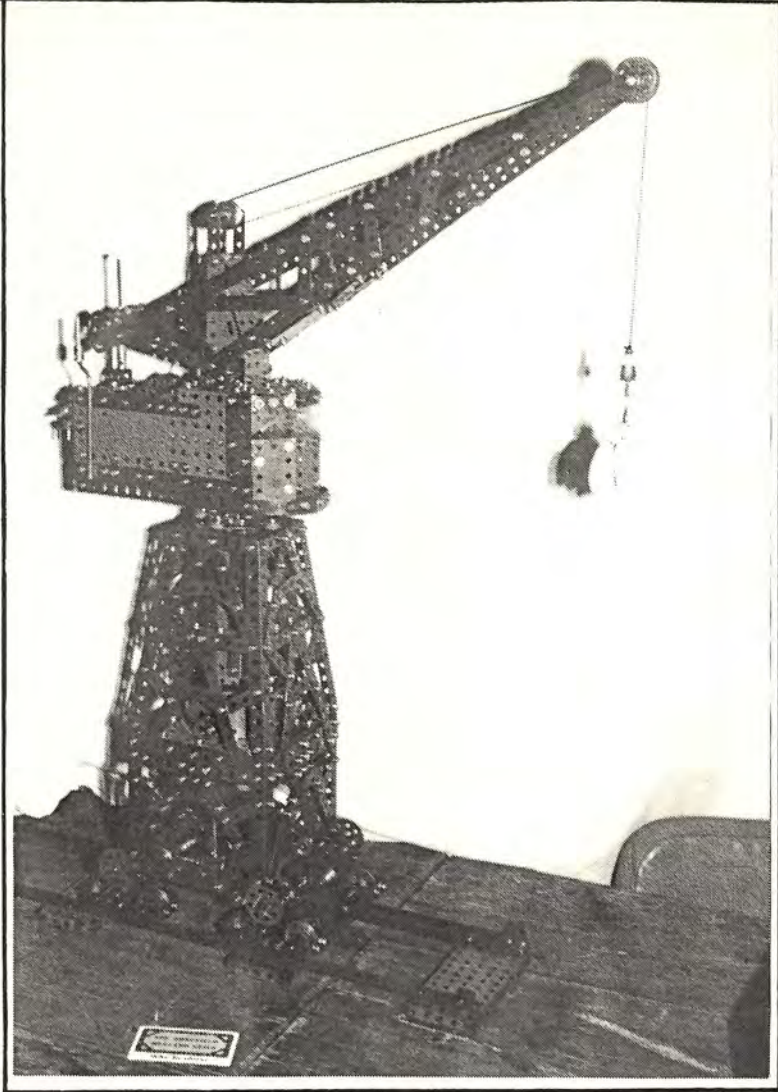

S M G

- NEWS -

No. 33

MARCH 1991

THE SHEFFIELD
MECCANO GUILD

GUILD OFFICERS:

CHAIRMAN-

Charles Hatfield,

PRESIDENT-

Richard Bingham,

TREASURER-

Stephen Parkin,

SECRETARY-

Mike Beadman,

NEWSLETTER EDITOR-

Rob Mitchell,

SMG News is produced quarterly by the Sheffield Meccano Guild in March, June, September, and December of each year.

Both the SMG Secretary and Newsletter Editor welcome any items sent in by SMG members (or others!) for inclusion in SMG News. There are no copy dates or deadlines; contributions will be included in the next issue.

Editorial

This issue of SMG News has been put together with some haste so as to get it posted before our annual public exhibition at Kelham Island. I hope that the joins due to the frantic activity do not show too much! Details of the exhibition are enclosed, and a map showing the venue (and Norton) were included in the December 1990 SMG News. The SMG Trophy, currently held by John Bader, will be awarded on the usual basis of exhibitor's votes.

Also mentioned in the last issue was our annual auction, to be held during the Spring meeting on 10th. April. The SMG's hydraulic set, given by Hydro Action, will hopefully be up for grabs; please bring any other items that you want to dispose of in the fracas!

As promised in the 1990 AGM, a membership list is included with this issue. Those members who wished to remain confidential have been omitted from this list.

Contents

Secretary's Scribblings.....	1
Diary Dates.....	1
Meccano Froth	
Floatation Cells.....	2, 3, 4, & 5
SMG Mega-model no.3.....	6
Lionel Model Railway Exhibition,	
Ilkley.....	6
The 1991 Atlascraft Leaflet.....	7, 8, & 9
For Sale.....	10
Hydraulic Engine.....	10&11

Thanks go to Dave Yates, from Bolsover, for kindly producing half tones of photos for reproduction in SMG News.

COVER PICTURE

A table-top level luffing dock crane built by Rob Mitchell and photographed (as usual!) by Robin Scholar at a past Skegex. The model sported all four movements driven by a single MO in the cabin. Travelling was through 8-wheel drive on 5" gauge track.

Once again, thanks go to Carl Huteson, the computer boffin, for allowing the editor's clumsy hands on his revered BBC and printer, to produce many titles for the newsletter.

SECRETARY'S SCRIBBLINGS

EVEN A SMALL Newsletter such as this seems to have an insatiable appetite for material. Thanks to the ever creative and helpful Guild members, SMG NEWS has, hopefully, something to please everyone. If you think there's something missing, please tell us; likewise, if something in the Newsletter does not appeal, Rob and myself want to know.

One thing we DO know is that the low cost of Guild membership is appreciated. One part of this restraint is that SMG NEWS is deliberately kept down to fourteen pages or less in size, in order to sneak in under the postage weight limit! As a consequence, if you have a 'big' article, such as a model description, over four sides in length, may I suggest that CQ or NEWSMAG are the folks to deal with it. Otherwise, anything Meccano related is welcome.

With luck and a following wind, this issue will be out before the Guild Exhibition at Kelham Island. Do come if you can, with or without model. Kelham Island Industrial Museum is an interesting and appropriate venue, now rumoured to be developing an 'outstation' near Hillsborough. Also, the Pub Grub and real ale at the 'Fat Cat' nearby come highly recommended. Snacks and drinks are also available at the museum- the cafeteria is next door to the Exhibition Room.

DIARY DATES

- March 9th North East London Meccano Club, Club Meeting, Barkingside
- March 16th West London Meccano Society, Club Meeting, Greenford.
- March 16th/17th SHEFFIELD MECCANO GUILD, ANNUAL EXHIBITION, KELHAM ISLAND INDUSTRIAL MUSEUM, SHEFFIELD (Alma Rd., off Corporation St.)
- March 30th Midlands Meccano Guild, Arthur Rank Centre, Royal Showground, Stoneleigh
- April 27th SHEFFIELD MECCANO GUILD, CLUB MEETING, NORTON CHURCH HALL
- April 27th Holy Trinity Meccano Club, Club Meeting, Hildenborough
- May 5th Sussex Vintage Model Railway Club & Meccano Exhibition, Hove Town Hall (Details, Michael Edwardes 0273-561840)
- May 18th NORTH MIDLANDS MECCANO GUILD, CLUB MEETING, OXTON.
- May 25th Henley Society of Meccano Engineers, Club Meeting, Henley.
- June 1st Runnymede Meccano Guild, Club Meeting, Ottershaw.
- June 15th North East London Meccano Club, Club Meeting, Barkingside.
- June 22nd West London Meccano Society, Club Meeting, Greenford.
- July 5th/7th SKEGEX '91
- July 27th Henley Society of Meccano Engineers, Club Meeting, Henley.
- August 17th/18th Lincolnshire Steam Spectacular with Meccano Section. (details Pete Pyefinch 0522-682443).
- August 30th/31st HENLEY EXHIBITION
- September 21st NORTH MIDLANDS MECCANO GUILD, CLUB MEETING & AGM, OXTON
- October 19th SHEFFIELD MECCANO GUILD, CLUB MEETING & AGM, NORTON.

MECCANO FROTH FLOATATION CELLS

INTRODUCTION

Froth Floatation is a process discovered at the turn of the 20th. Century. It involves the property of an air bubble to stick more to one surface than another due to the effect of surface tension. The addition of a particular chemical, or reagent, can enhance this effect to give a clean separation of waste from a desired material. Alternatively, froth floatation can effectively separate two value materials; a good example is the separation of Galena (PbS) and Sphalerite (ZnS), which are the major ores of lead and zinc. Their separation by any other means is flawed by their similar densities, whereas floatation is almost independent of S.G.

The mixed ore tends to be a fairly consistent mix of Galena, Sphalerite, and waste rock and minerals (gangue). After crushing, the whole lot is

separated by density to remove the gangue, and then the lead & zinc ores are ground to a coarse slurry (approximately 2mm) and then sent to the froth floatation cells. The cell is a box with a propeller/agitator in the bottom into which the slurry is admitted. Air is pumped down the hollow agitator shaft, and the reagent slowly added. The froth generated contains one mineral (the mineral is dictated by the reagent used), and the

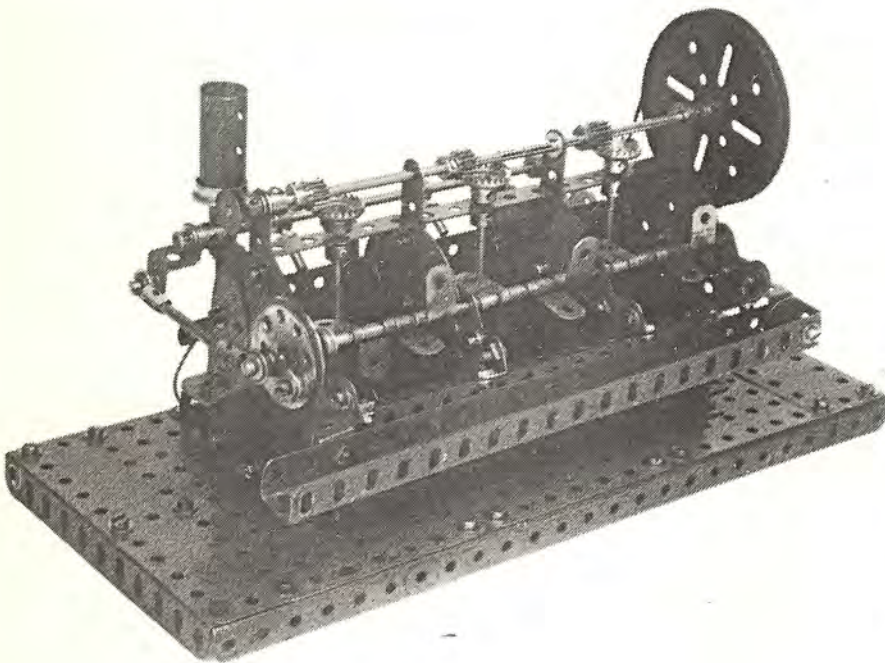

ABOVE- Photo 1
Front view

RIGHT- Photo 2
Rear view

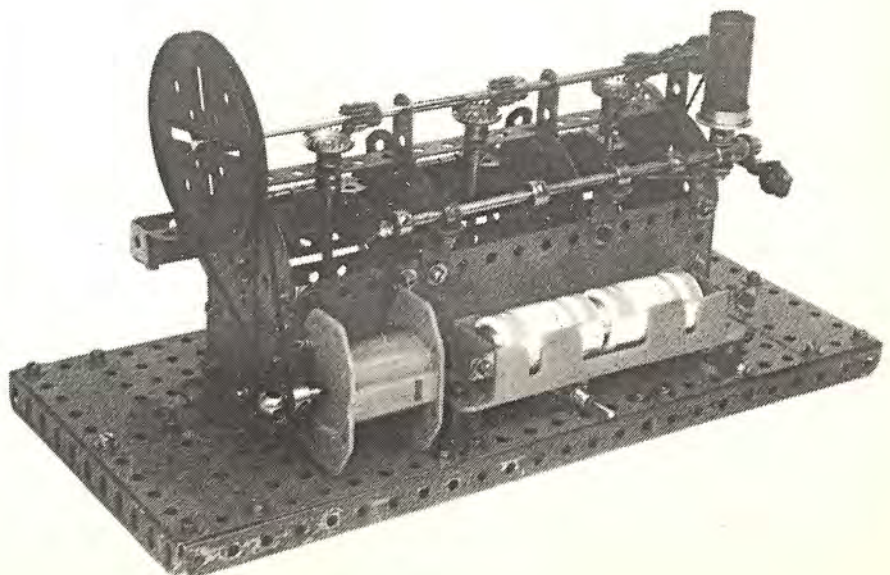

other sinks to the bottom where it is drawn off. A set of paddles remove the froth over a weir and in to a collecting channel (launder) for any further processing.

THE MODEL

The Meccano cells represent a bank of three machines driven from a common overhead shaft. All mechanisms are included, with the extra addition of a lo-flo reagent pump. There is no particular prototype, but the model is generally typical of a floatation machine.

CONSTRUCTION

A)- Base.

Photos 1 & 2 show the front and reverse of the model on its base. It is constructed from pairs of $12\frac{1}{2}$ " & $5\frac{1}{2}$ " angle girders in a rectangle, overlaid by three butted $5\frac{1}{2}$ "x $3\frac{1}{2}$ " flat plates and two $5\frac{1}{2}$ "x $1\frac{1}{2}$ " flexible plates at the ends. A transverse $12\frac{1}{2}$ " strip underneath the plates adds a little more rigidity.

B)- Ends & Dividers.

A mirror image of each is required in addition to those in Figs. 1 & 2. Each is made from a $2\frac{1}{2}$ "x $2\frac{1}{2}$ " flexible plate, a semicircular plate, a $3\frac{1}{2}$ "x 2 " triangular flexible plate, a $4\frac{1}{2}$ " strip, two angle brackets, and a $2\frac{1}{2}$ "x $\frac{1}{2}$ " double angle strip. Photo 3 shows the top of one end. Also, the ends each have an extra $2\frac{1}{2}$ "x $\frac{1}{2}$ " double angle strip and an outer $2\frac{1}{2}$ " angle girder along their bottom edge. All of the four assemblies are joined together by three $2\frac{1}{2}$ "x $\frac{1}{2}$ " double angle strips, three holes down from the top of the $4\frac{1}{2}$ " strips, as in photos 1-4.

FIG. 1 END -inside

FIG. 2 DIVIDER

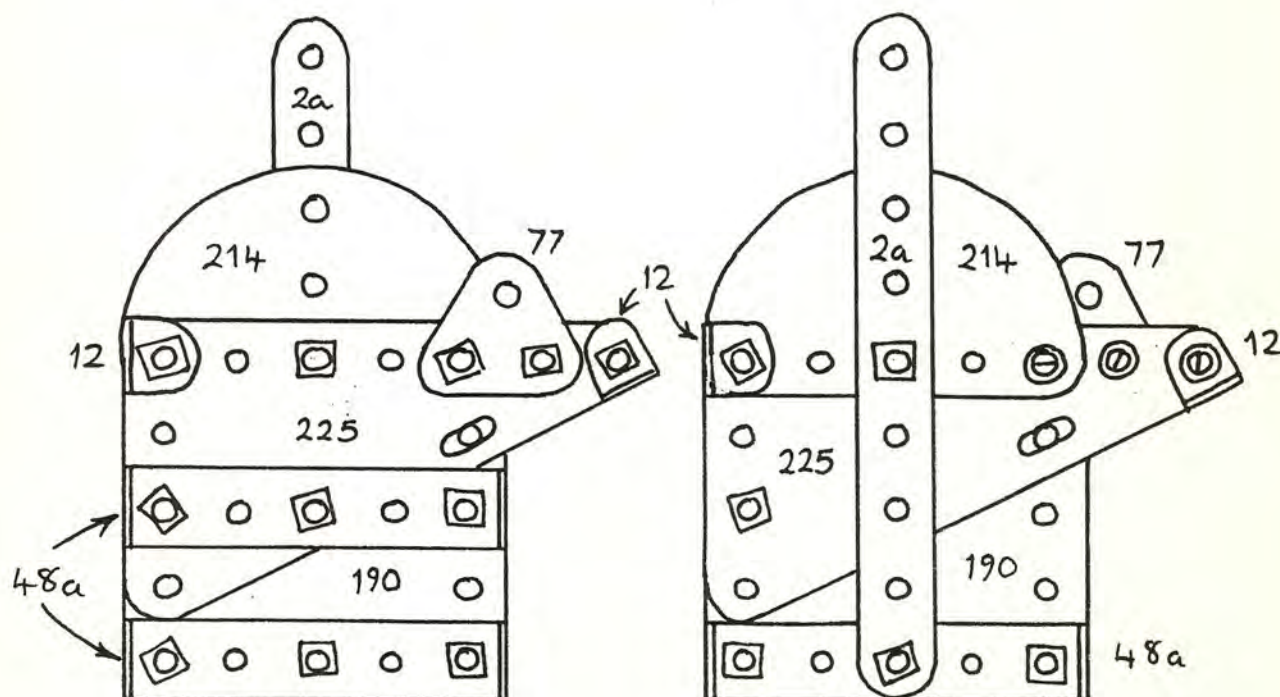

C)- Sides

The rear, or motor, side is a $7\frac{1}{2}$ "x $2\frac{1}{2}$ " strip plate with bolts through all vacant end and divider lugs, with a $7\frac{1}{2}$ " angle girder along its bottom edge. The front, or launder, side, is similar but is made from a pair of overlapped $5\frac{1}{2}$ "x $1\frac{1}{2}$ " flexible plates. Three $2\frac{1}{2}$ "x $\frac{1}{2}$ " double angle strips run front to back in the bottom of the three cells to form bearings for the agitators, photo 4. A $7\frac{1}{2}$ " flat girder is bolted under the projecting $3\frac{1}{2}$ "x 2 " triangular plates, photo 4, to make the weir. The launder is a pair of $9\frac{1}{2}$ " angle girders formed into a channel section,

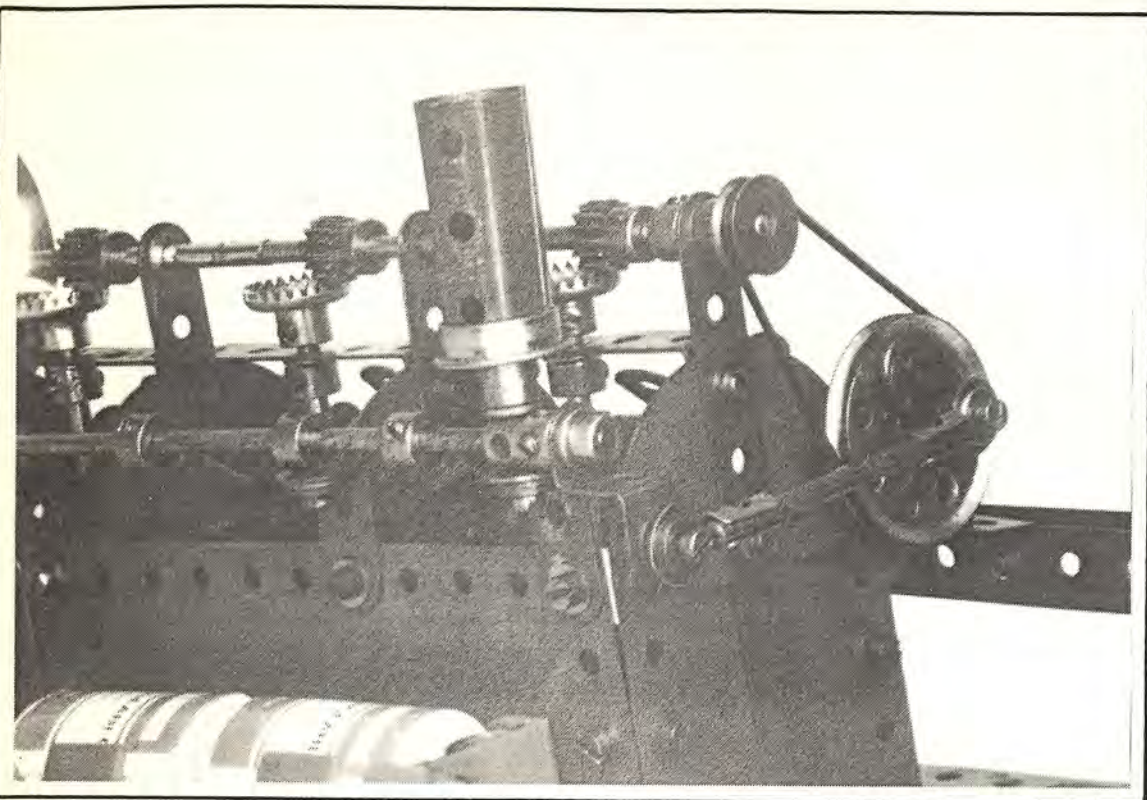

LEFT- Photo 3
Detail of
reagent pump
and delivery
system

closed off at one end by a double bracket, photo 1. It is attached by a pair of corner angle brackets to the two ends, and use of the bracket slots give a gentle slope towards the open end.

The now complete cell structure can now be attached centrally to the base, bolting through the bottom flanges of the $7\frac{1}{2}$ " angle girders. Make sure that the top holes of the $4\frac{1}{2}$ " strips and the 1" triangular plates are in line with one another!

D)- The Works

Each agitator is built from a 3" axle rod, a 25-tooth contrate, a collar, a rod socket, a pair of five hole 2" strips, and a couple of washers. Photo 4 shows two agitators. The two 2" strips are bolted onto the rod socket by their central holes into a cross. The small remaining portion of the rod socket thread enters the middle holes of the $2\frac{1}{2} \times \frac{1}{2}$ " double angle strips in the bottom of the cells. If there is room, use a washer between the nut and the double angle strip! A collar and washer under the top double angle strips retains the agitator, and the 25-tooth contrate takes the drive.

The common drive shaft is a 5" and a 4" axle rod joined by a rod connector. A couple of collars retain the shaft, and three 15-tooth pinions mesh with each agitator contrate. A 3" pulley receives the motor drive, and a $\frac{1}{2}$ " pulley on the other end drives the paddles.

The paddle shaft is an 8" axle rod journalled in the vacant holes of the 1" triangular plates. A $1\frac{1}{2}$ " pulley is driven via a 6" driving band from the $\frac{1}{2}$ " pulley. The paddles are rod & strip connectors, four per cell, each offset from its neighbour by 90 degrees. Space may be tight (especially in the middle cell), so some judicious washer spacing may be in order.

The M0 motor has a handrail coupling on its shaft, the neck of which forms a small diameter pulley. Photo 2 shows the motor mounting; a $1\frac{1}{2}$ " flat girder at the motor front and a vertical $2\frac{1}{2}$ " angle girder at the back. A $1\frac{1}{2}$ " strip packs the angle girder away from the motor if necessary. The battery holder is attached to and stood off the base by a pair of reversed angle brackets. A 10" driving band connects the handrail coupling to the 3" pulley.

E)- Reagent Pumping

A fishplate is bolted, by a 3/8" bolt, to the face of the 1½" pulley and arranged to give a short throw in a similar manner to the return crank on Walscheart's valve gear, and is stood off by three washers. A connecting rod is made from a pair of rod & strip connectors and a 2½" axle rod. The pump, reservoir and 'plumbing' are all attached to the rear side by three 1"x½" angle brackets and collars, photos 2 & 3. A 6½" axle rod forms the pipe, from which three threaded pins represent nozzles, one into each cell, photo 4. The pump is a short coupling; the 6½" axle rod projects through this, and on it pivots a reversed angle bracket retained by a collar (a normal collar can be substituted). The connecting rod is locknuttred onto the bracket, photo 3. Finally, a vertical sleeve piece represents the reagent reservoir, held in a ¾" flanged wheel attached to the short coupling by a 3/8" bolt.

PARTS REQUIRED

1 of no. 1	1 of no. 14	26 of no. 38	1 of no. 154a
4 " " 2a	1 " " 15	12 " " 48a	1 " " 154b
6 " " 6	1 " " 15b	3 " " 52a	1 " " 163a
1 " " 6a	1 " " 16a	7 " " 59	3 " " 179
2 " " 8	3 " " 16b	1 " " 59a	1 " " 186a
2 " " 8a	1 " " 19b	1 " " 63d	1 " " 186b
2 " " 8b	1 " " 20b	4 " " 77	4 " " 189
2 " " 9	1 " " 21	1 " " 103h	4 " " 190
3 " " 9d	1 " " 23a	1 " " 103k	1 " " 198
1 " " 10	3 " " 26c	3 " " 111a	2 " " 212
1 " " 11	3 " " 29	1 " " 111c	12 " " 212a
4 " " 12	110 " " 37	3 " " 115	3 " " 213
3 " " 12b	8 " " 37a/c	3 " " 125	4 " " 214
1 " " 13a	3 " " 37b	1 " " 136	4 " " 225

1x battery holder; 2x battery contacts; 1x M0 motor.

BELOW- Photo 4 View inside cells showing agitators, drive, and paddles

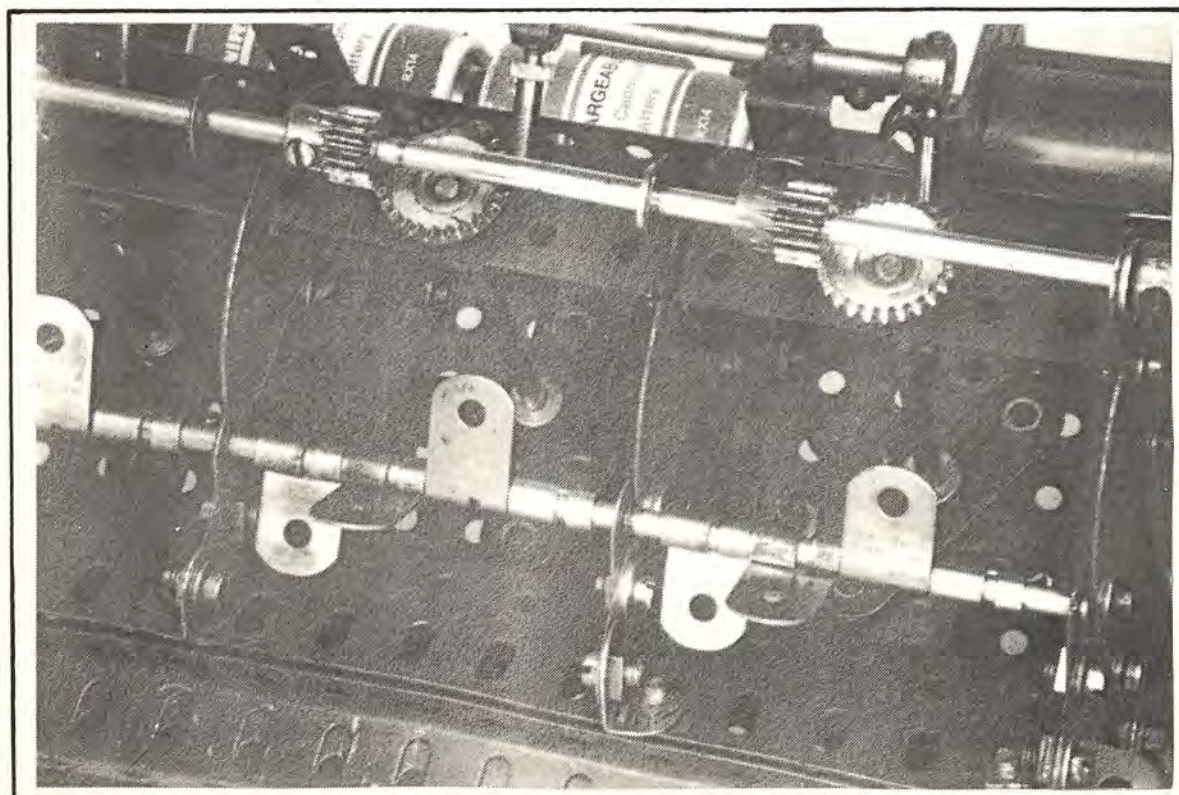

SMG MEGA-MODEL No. 3- KIDDIE CAR

-the third in this occasional series, and the most complex Mega-Model yet, sent in by HOWARD BOTTOM.

Two fork pieces are fixed onto a 1½" axle rod. Clamped between these are a 1"x½" angle bracket, an obtuse bracket, and a reversed angle bracket which form the bonnet, windscreen, and seat respectively. Another obtuse bracket is bolted to the front of the bonnet, the slotted hole of which represents the mascot; the rearward projecting axle makes the 'exhaust'. The wheels are 3/8" washers lock-nutted onto the lugs of the fork pieces.

PARTS REQUIRED

1 of no. 12b	8 of no. 38
2 " " 12c	4 " " 38d
1 " " 18a	4 " " 111c
1 " " 37	2 " " 116
8 " " 37a/c	1 " " 125

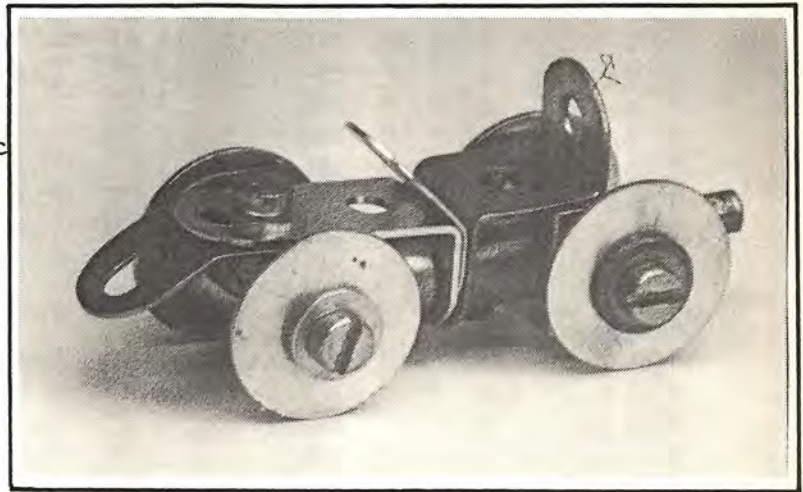

LIONEL MODEL RAILWAY EXHIBITION, ILKLEY

Alan Grimshaw sends this message to all interested modellers...

Will any members be able to help out with a Meccano display at the Ilkley Lionel Model Railway Exhibition? If you can, please **contact**, by writing or phoning:

VENUE- Winter Gardens, Ilkley
DATE- Saturday 1st. June
TIMES- 10:30 to 17:00

(Ed. Alan has mentioned in recent correspondence that he has been in Hospital. I am sure that all SMG members wish Alan well and hope for a speedy recovery.)

THE 1991 ATLASCRAFT LEAFLET

Press-ganged out of JOHN BADER
(sorry John!!)

Limited copies of this year's Atlascraft leaflet were distributed by Jim Gamble at the January 19th. NMMG meeting at Oxton.

This year sees the 90th. anniversary of the metal marvel so it seems a fitting tribute to Frank Hornby to find inside the leaflet a picture of an original 90 year old 'Mechanics Made Easy' set together with one of the latest no.4 sets, complete with new Meccano logo!

Nothing new seems to have happened to Plastic, or Junior Meccano as it is known. There are some new additions to the small one-model sets in the form of four 'Utility Vehicles', these being a Breakdown Vehicle, a Rescue Helicopter, a Water Cannon, and a Road Leveller. These boxes contain $\frac{1}{2}$ " and 1" plastic pulleys in red; also red-painted 2 and 3 hole flat girders. Interestingly, the Road Leveller, which contains no red painted parts, appears to contain yellow $\frac{1}{2}$ " plastic pulleys. Most of the 'Agricultural' series to have been discontinued, although the Tractor with Cabin has been moved into the 'Construction' series, apparently replacing the Motor Scraper.

Much of this will be of little interest to true Meccanomen, being SMG members, so onto more important matters concerning the introduction of a new 6 volt motor, a sample of which was on show at Oxton. Moulded in black plastic, it is reported to be of similar power to the Crane Kit motor, although of much smaller size. Very compact looking, its dimensions being about a 3-hole cube. The on/off/reverse switch is mounted 'down the wire'. Smaller battery holders have been designed to take R6, or AA type cells. This motor is called the M0 and replaces the red M0 (?)

By far the major change is that of the 'Beginners Series', consisting of outfits 1 to 4, all but outfit 1 containing the new motor. Apart from redesigned Road Wheels, the basic contents of the sets seem to remain virtually unchanged, the big difference being in the completely new instruction manuals. How refreshing to look at models with NO BENT PLATES!! This must surely be the most major breakthrough yet. No longer will the sets be rendered useless after the construction of the first model. The two smaller 'Enthusiasts' series sets, 5 and 6, also containing the new motor, also feature completely new model books. Such bent plates as can be found merely resort to very slight curvature, from which the metal can recover, or the use of plastic plates, or parts 199 & 200. Set 6 looks as though it contains 8 of the new wheels. Unfortunately, these two sets also contain the dreaded Allen type bolts. But what a difference to see completely new models featuring no mutilation of valuable parts. 'Enthusiasts' sets 7 to 10 remain unchanged. Possibly the instruction books and leaflets for these larger sets will be revamped in due course. Jim Gamble's excellent model of a Lancaster Bomber (complete with bent plates!) has taxied onto the last page. The back cover assures us that Gearbox motors, MR motors, Mechanisms sets, Conversion sets, and spare parts are all still available.

BEGINNERS

SERIES

METAL
METALLO

MECCANO

METAL
METALLO

MECCANO

51
MODELS
POSSIBILI
MODELLI
POSSIBILI



NEW
ELECTRIC MOTOR
& PARTS

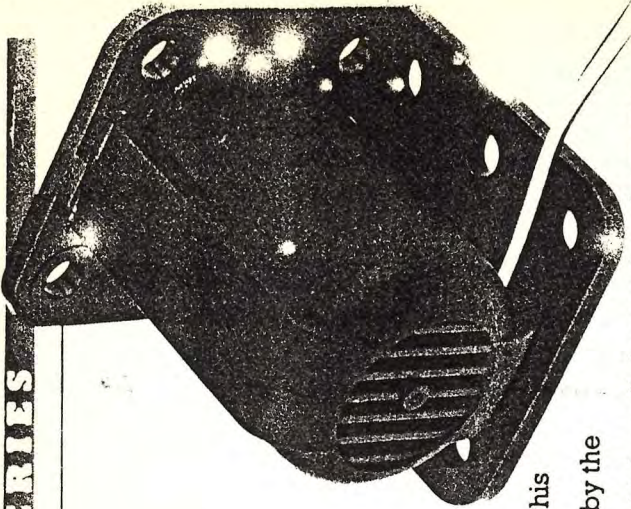
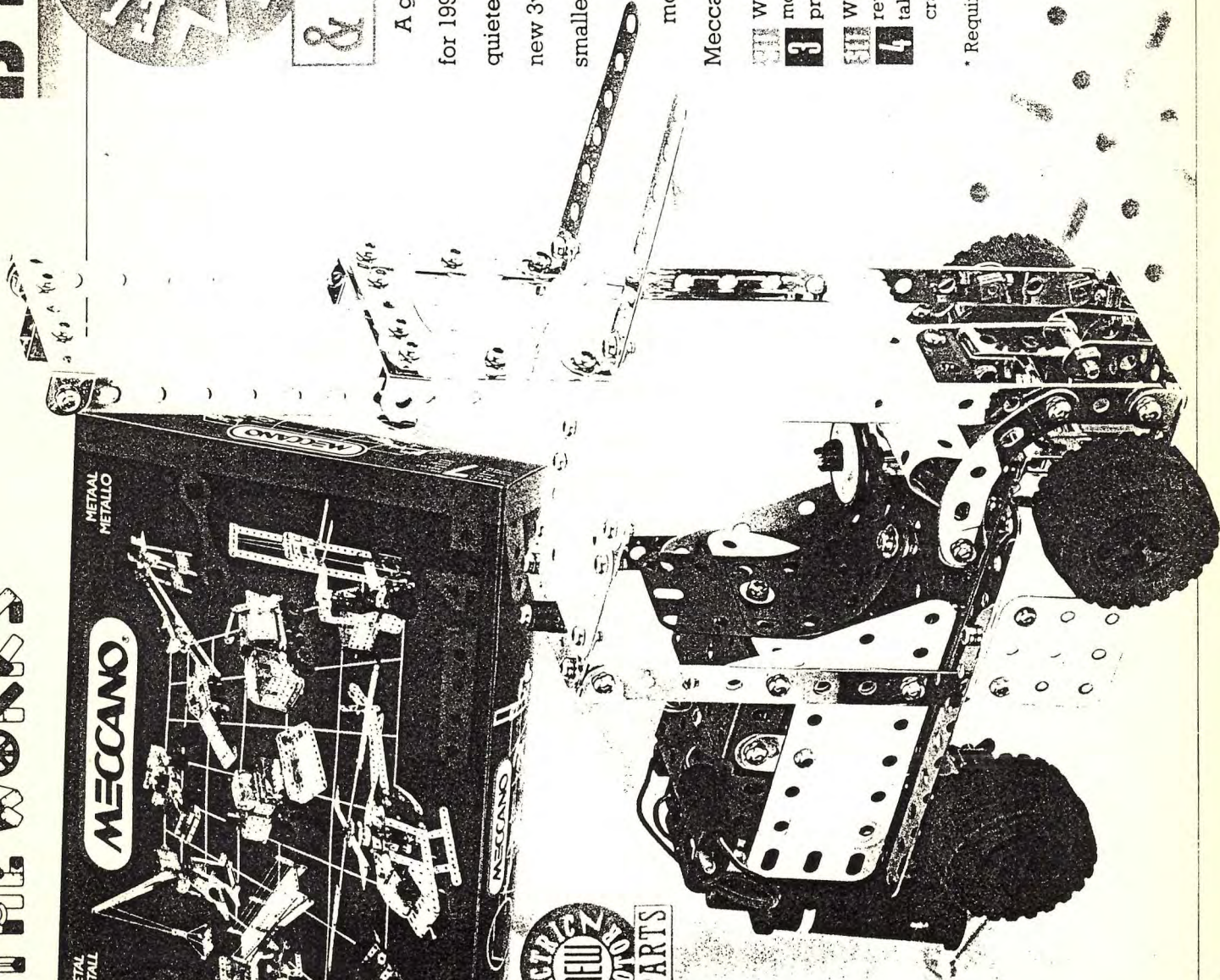

NEW
ELECTRIC MOTOR
& PARTS

A great new motor

for 1991. More efficient,

quieter and more durable this

new 3v/6v motor is driven by the

smaller R6 style batteries which are lighter and can be more

easily integrated into the motor driven models. Altogether

more realistic the new motor adds a new dimension to the

Meccano range.

With Electric Motor**. The purchase of a Set 3 includes additional models making 39 in all from the 353 parts. Why not build the truck prime mover or the dragster racing car?

With Electric Motor**. Additional transmission parts and a motor reversing capability are included in this 452 part set. Further models take the total to 51 in this fabulous set. A truck skiploader, dockside crane and grand prix racing car are just three examples.

* Requires 2 R6 batteries - not included. ** Requires 4 R6 batteries - not included.

UTILITY VEHICLES

9 different sets for the 6 year olds and older to contemplate as their introduction to the traditional metal Meccano. For the slightly younger modeller each set uses standard metal Meccano and using simple step by step instructions builds the illustrated model. 1991 sees four new sets including a range of Emergency vehicles.

It is fun to build - great fun to play with!

- 311** Breakdown Vehicle - 190 parts in this all wheel drive vehicle.
- 301** Rescue Helicopter - 155 parts make this helicopter with moving rotor blades.
- 302** Motorised Water-Cannon - This fire fighting machine has 170 parts.
- 303** Road Leveller - 165 parts make up this heavy machine.
- 109**

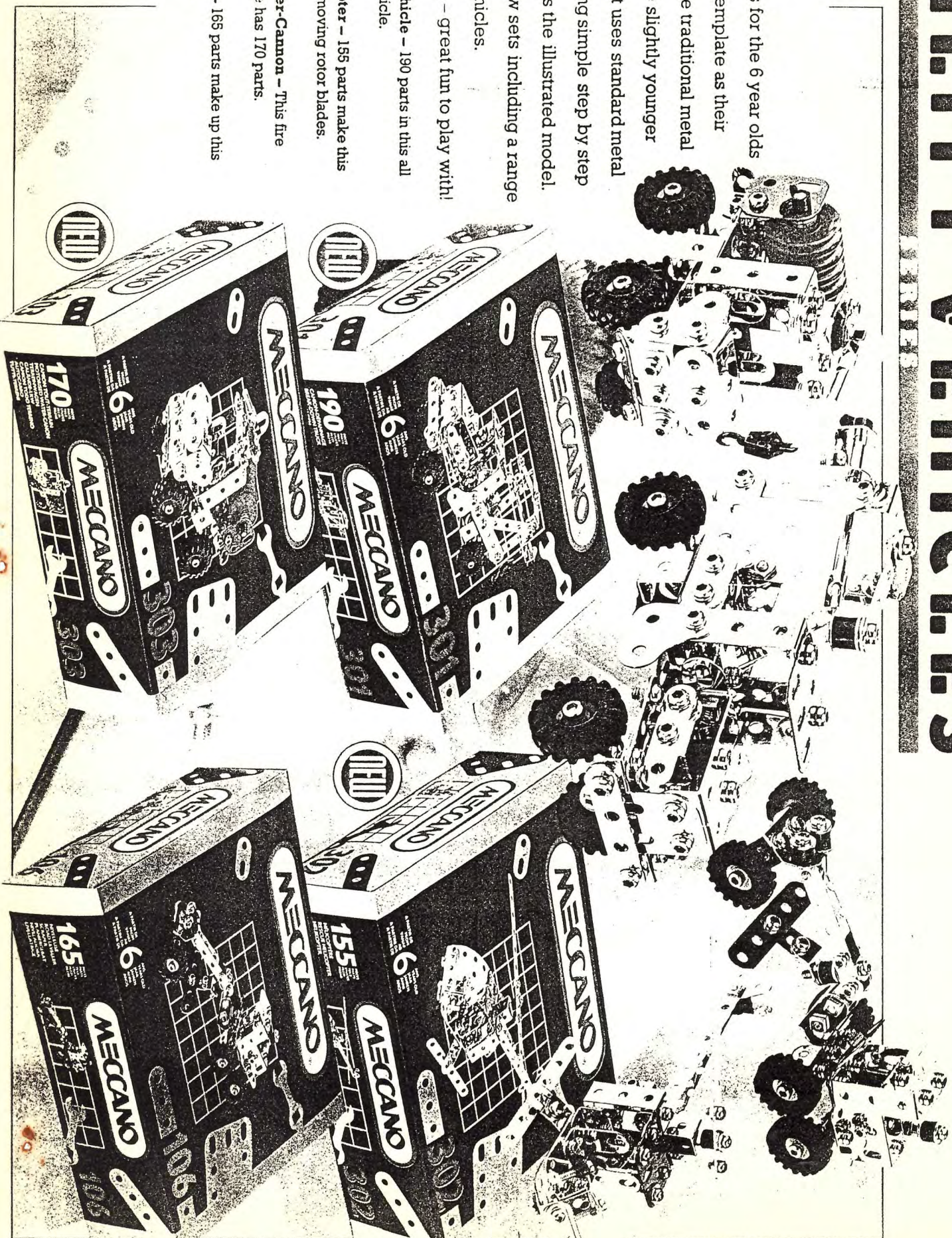

HYDRAULIC ENGINE

Designed and described
by Mike Beadman

This model, using HYDRO ACTION hydraulic components, is a classic case of 'a solution looking for a problem'. There was never much call for reciprocating engines of this kind, although some were used on docks where there was a risk of fire from steam or oil engines, before electric motors became widespread.

Simply, I just wondered whether it was possible to make a working 'engine' using HYDRO ACTION bits. This design, the second attempt at same, works fairly reliably, but has little power to spare. The reversing valves are intended to be hand operated, and require considerable effort to move.

Why two cylinders? Or rather, why have a second cylinder to work the valve gear? This is due to a basic limitation of this kind of engine. Unlike a steam or oil engine, this one does not run freely. Water does not compress, and the ram is under power all the time it is moving.

So, if you tried making a ram work it's own reversing valve, the instant the valve reaches the middle 'off' position, the whole thing comes to a shuddering halt. A steam engine would keep turning far enough to reverse the valve.

The second cylinder is therefore a 'servo'. The drive cylinder reverses the servo cylinder, which then moves the power cylinder's valve.

It would be perfectly feasible to have both cylinders actually driving, ie two cranks, but no more power would be gained. Two pumps would be needed to maintain the ram speeds, and there would be great danger of the rams 'fighting' each other if the valve timing was even slightly out.

Some provision has to be made to allow for the 'all or nothing' power of the ram. The 'telescopic' connecting rod may not be new, but is certainly unusual, and gives some flexibility while the crank is at dead centre. Likewise, in the event of things getting really out of hand, the Rod and Strip Connector linking the conrod to the crank will come undone. A HYDRO ACTION ram has enough power to damage a model if something goes wrong. But, like using a powerful electric motor in a MECCANO model, this is just part of the fun.

Two other features of the model to note; the upper crosshead slide rod doubles as a valve pushrod; and the flywheels are geared up from the crank by 15:1 because the rams move rather slowly.

..... FOR SALE.....FOR SALE.....

Five Hole Couplings, £2.25 ea.

Other Repro. Brassware, including 4:1 HELICAL GEARS

at competitive prices.

GEOFF BROWN

HYDRAULIC ENGINE
USING
"HYDRO-ACTION"
COMPONENTS

Mike Beadman

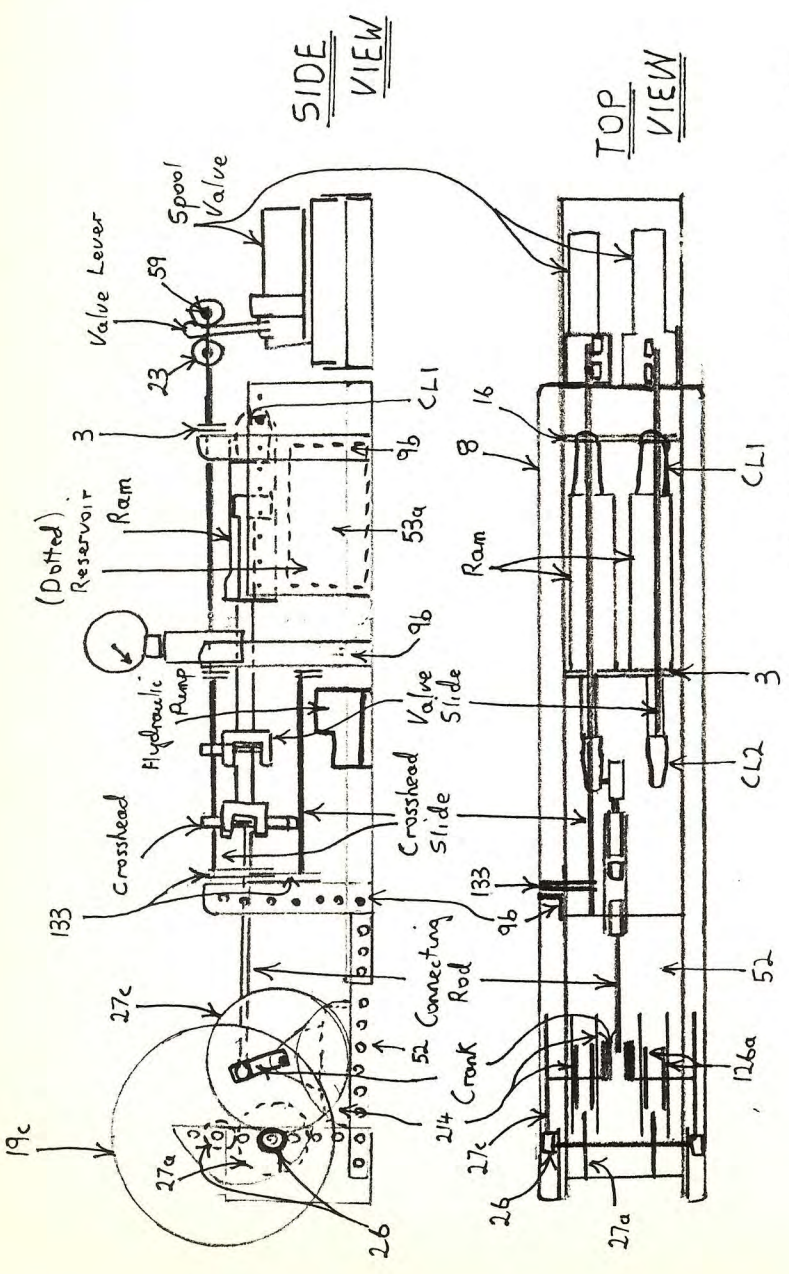

FULL SIZE SIDE VIEW OF
CRANK, CONNECTING ROD, etc.

