

1

- S2 | 9.5 mm | 3/8" | x2
- B1 | 14.7 mm | 37/64" | x2
- x4
- x1
- x1
- x1
- x1

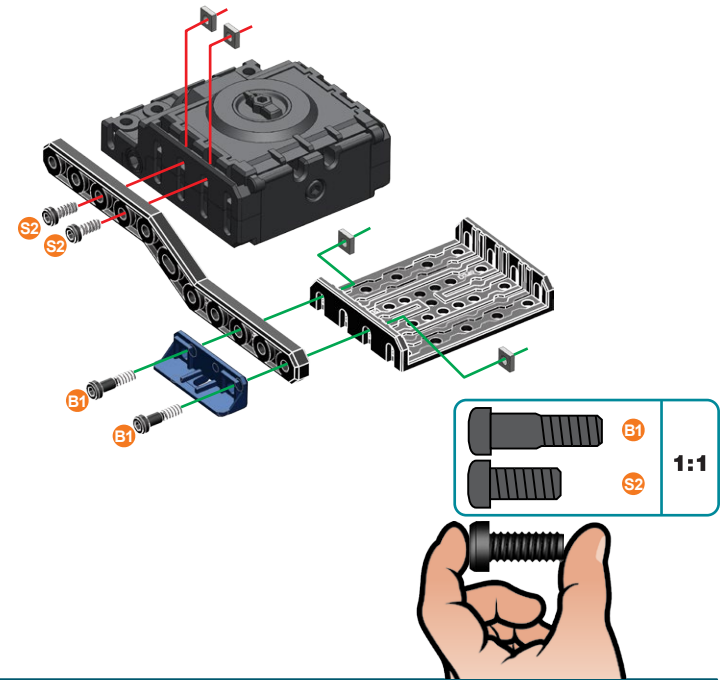

2

- S2 | 9.5 mm | 3/8" | x2
- x2
- x1
- x1

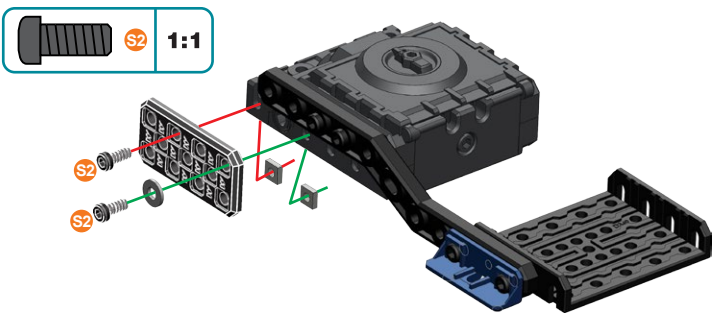



3

- S2 | 9.5 mm | 3/8" | x4
- B1 | 14.7 mm | 37/64" | x2
- x6
- x1
- x1
- x1
- x1

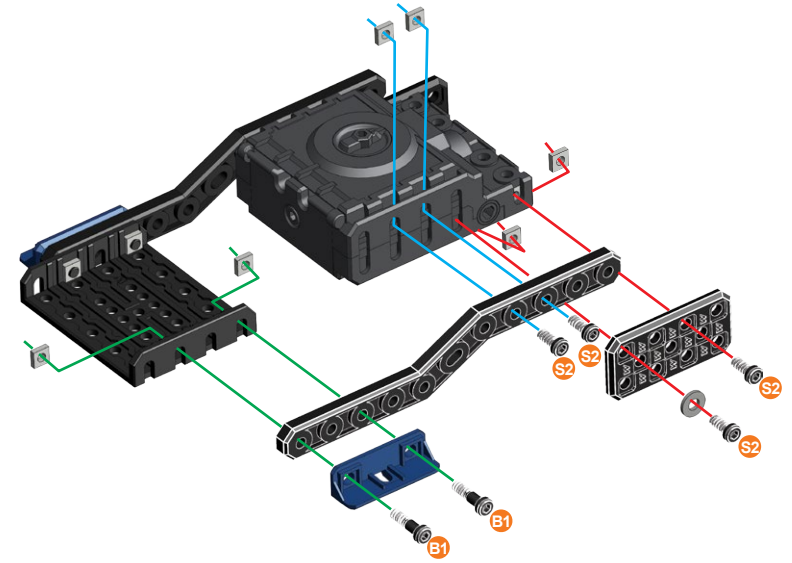
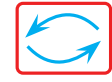
- B1
- S2
- 1:1



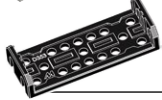

4

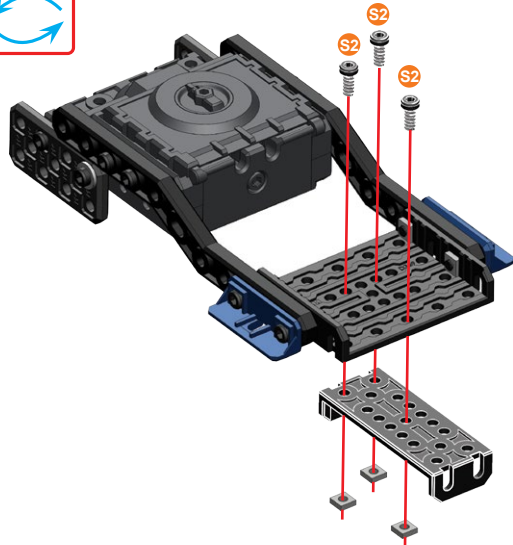
	9.5 mm 3/8"	x3
		x3
		x1



	S2	1:1
---	----	-----

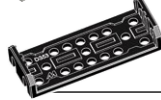

5

	9.5 mm 3/8"	x3
		x3
		x1

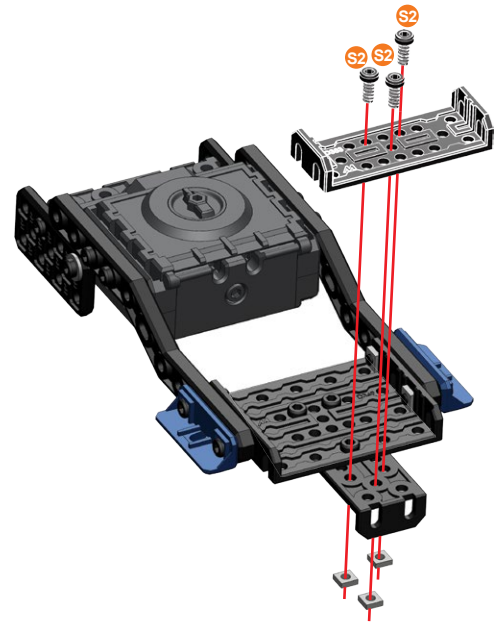
	S2	1:1
---	----	-----





6

	9.5 mm 3/8"	x4
		x4
		x2

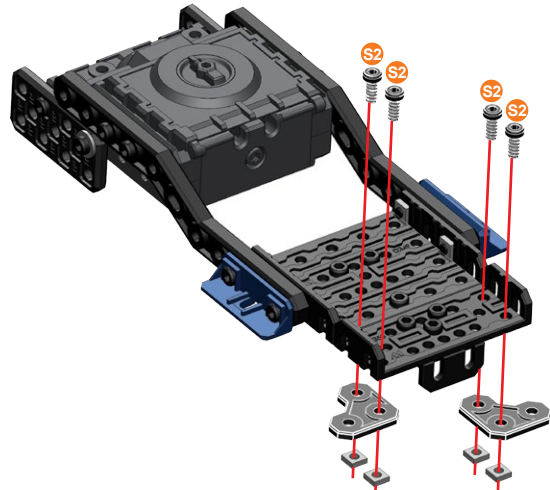
	S2	1:1
---	----	-----





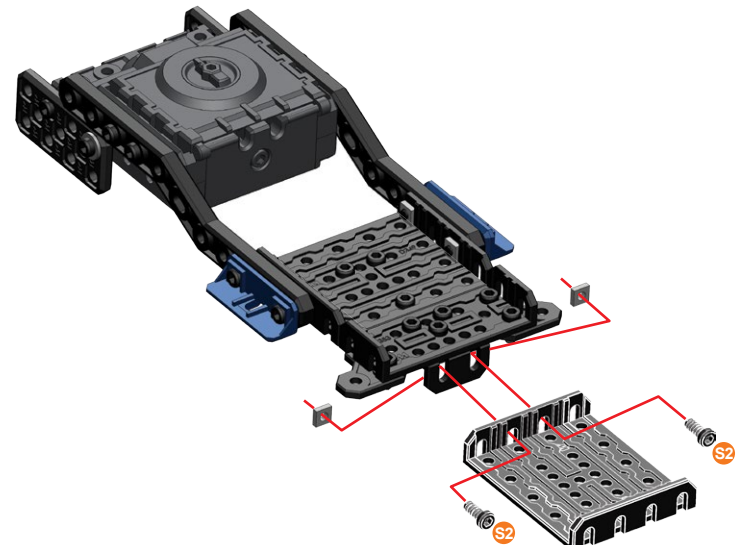

7

	9.5 mm 3/8"	x2
		x2
		x1

	S2	1:1
---	----	-----





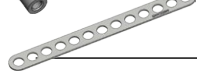

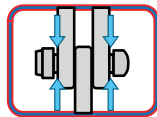
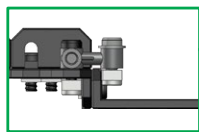
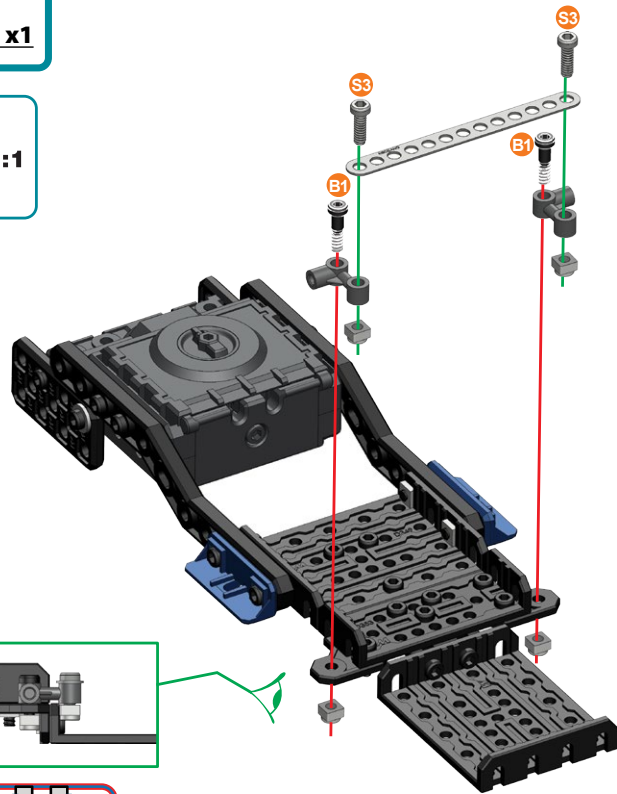
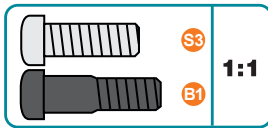

8

-  S3 | 12 mm | x2
1/2"
-  B1 | 14.7 mm | x2
37/64"
-  x4
-  x2
-  x1







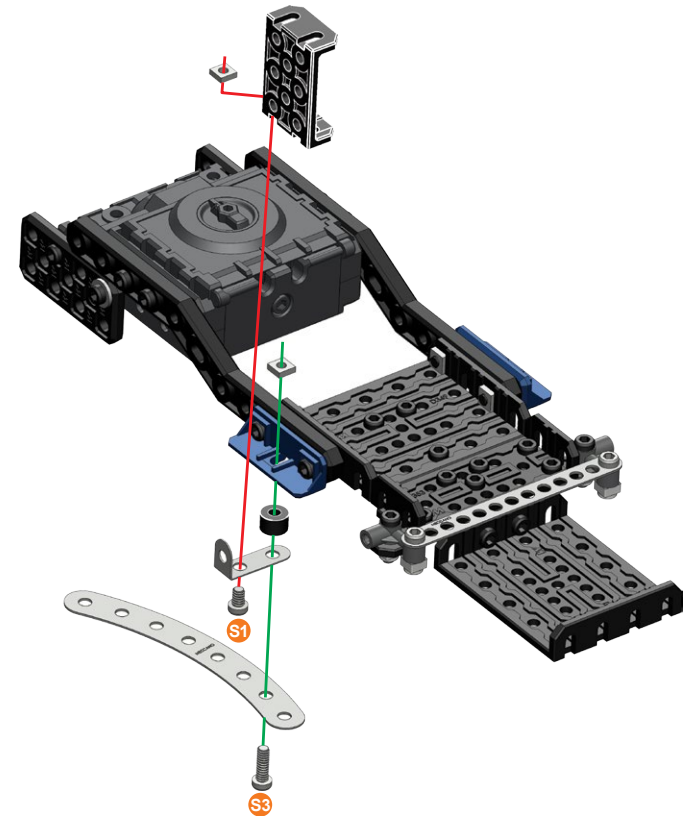
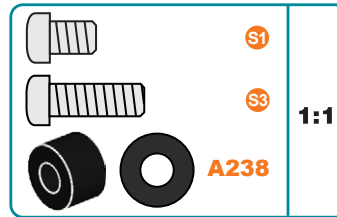

9



-  S1 | 5.8 mm | x1
15/64"
-  S3 | 12 mm | x1
1/2"
-  x2
-  x1
-  x1
-  x1
-  x1



10





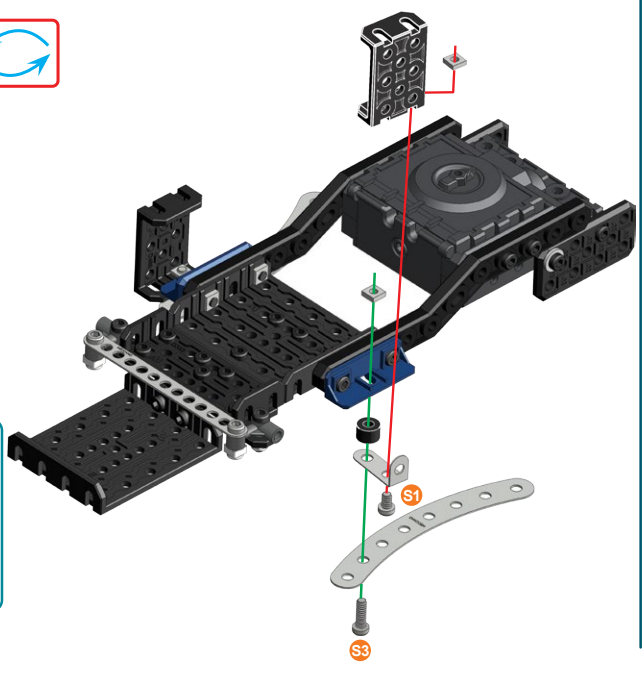

-  **S1** | 5.8 mm | **x1**
15/64"
-  **S3** | 12 mm | **x1**
1/2"
-  | **x2**
-  | **x1**
-  | **x1**
-  | **x1**
-  | **x1**





-  **S1**
-  **S3** | **1:1**
-  **A238**







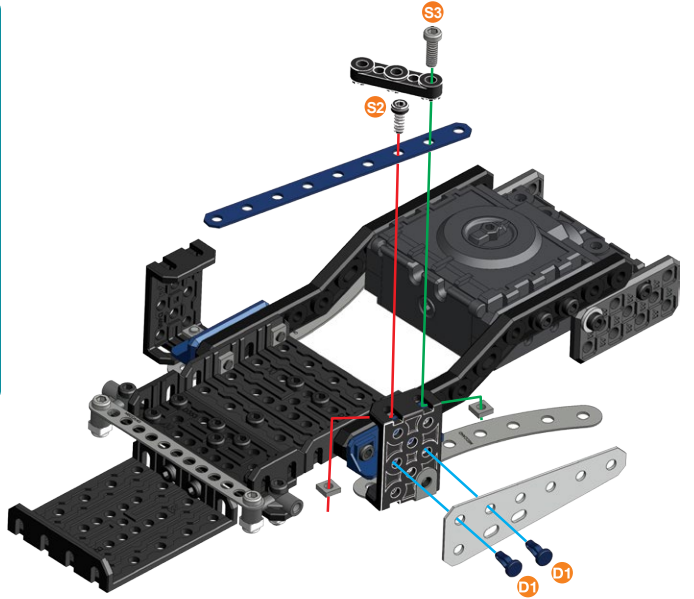

11

-  **S2** | 9.5 mm | **x1**
3/8"
-  **S3** | 12 mm | **x1**
1/2"
-  **D1** | 11.25mm | **x2**
7/16"
-  | **x2**
-  | **x1**
-  | **x1**



-  **S2**
-  **S3** | **1:1**
-  **D1**



12







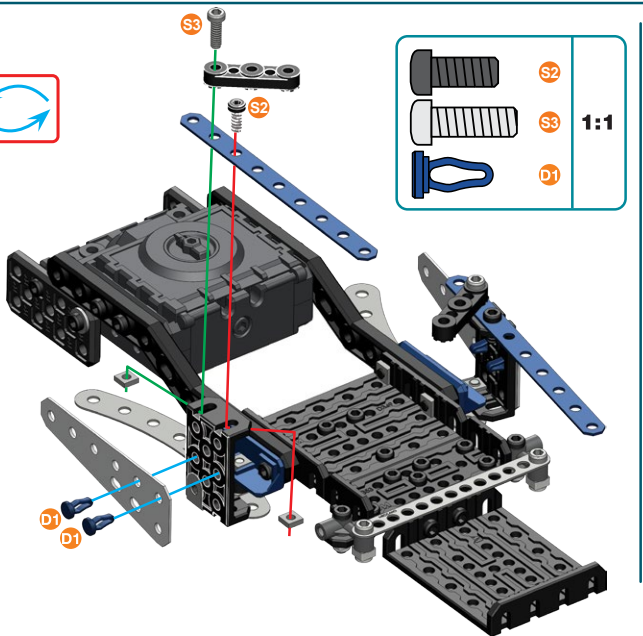

-  **S2** | 9.5 mm | **x1**
3/8"
-  **S3** | 12 mm | **x1**
1/2"
-  **D1** | 11.25mm | **x2**
7/16"
-  | **x2**
-  | **x1**
-  | **x1**
-  | **x1**





-  **S2**
-  **S3** | **1:1**
-  **D1**



13



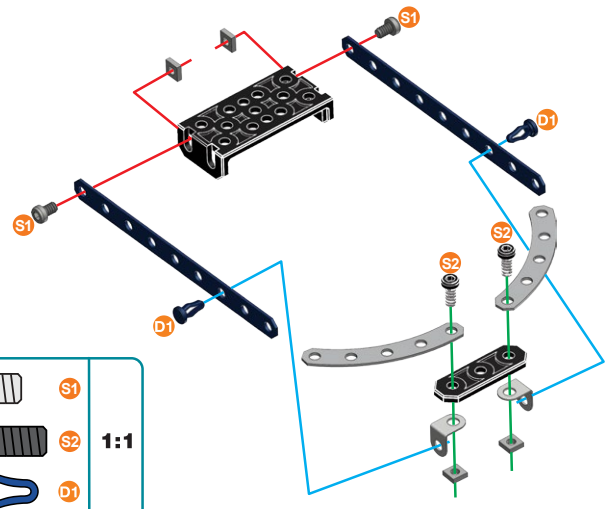

-  **D1** | 11.25mm | **x2**
7/16"
-  **S1** | 5.8 mm | **x2**
15/64"
-  **S2** | 9.5 mm | **x2**
3/8"
-  | **x4**
-  | **x2**
-  | **x1**
-  | **x2**
-  | **x1**
-  | **x2**

-  **S1**
-  **S2** | **1:1**
-  **D1**



14



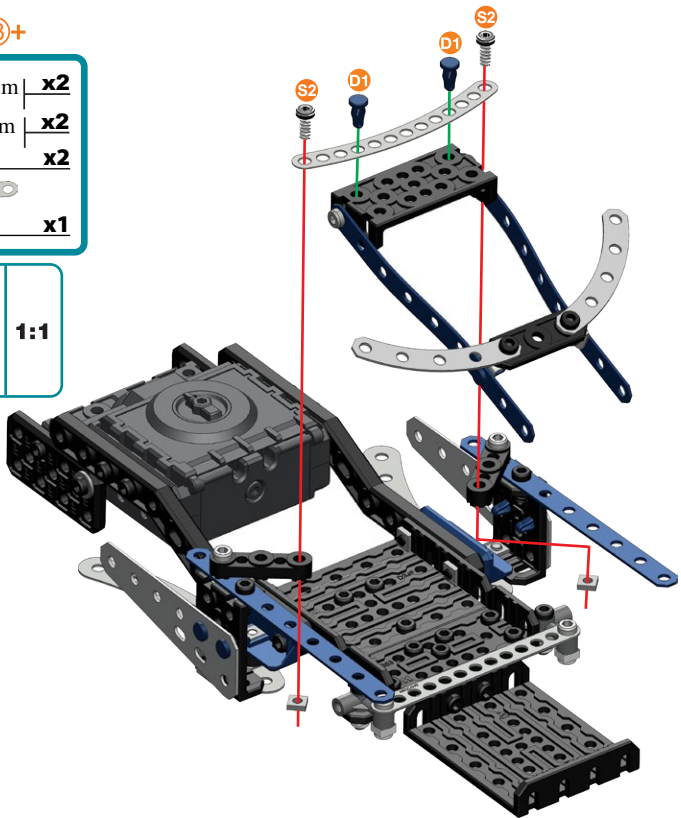

12+13+

-  **D1** | 11.25mm | **x2**
7/16"
-  **S2** | 9.5 mm | **x2**
3/8"
-  | | **x2**
-  | | **x1**

-  **S2**
-  **D1**
- 1:1**





15

-  **S1** | 5.8 mm | **x4**
15/64"
-  | | **x4**
-  | | **x2**
-  | | **x2**

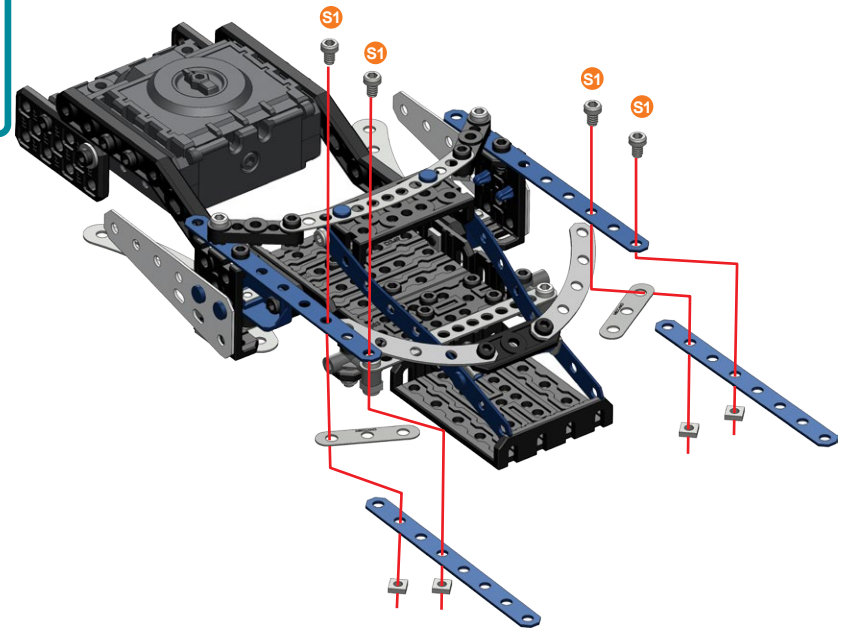
-  **S1**
- 1:1**





16

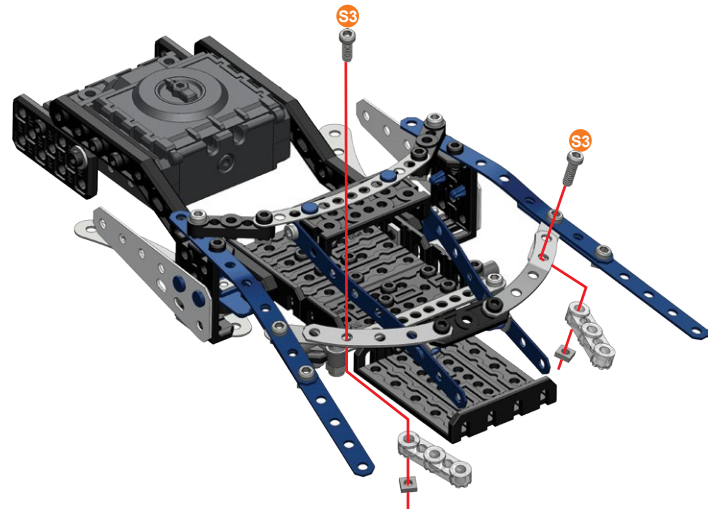

-  **S3** | 12 mm | **x2**
1/2"
-  | | **x2**
-  | | **x2**

-  **S3**
- 1:1**





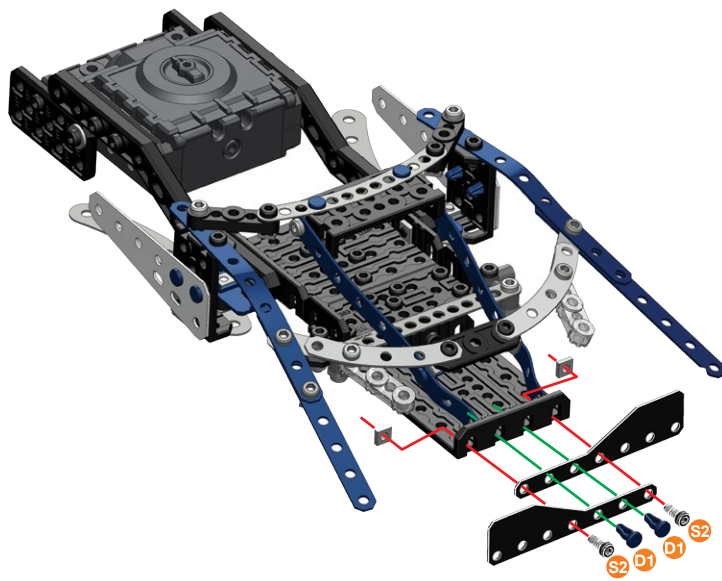

17

	D1	11.25mm 7/16"	x2
	S2	9.5 mm 3/8"	x2
			x2
			x2

	S2	1:1
	D1	





18

	S1	5.8 mm 15/64"	x2
			x2
			x2
			x2

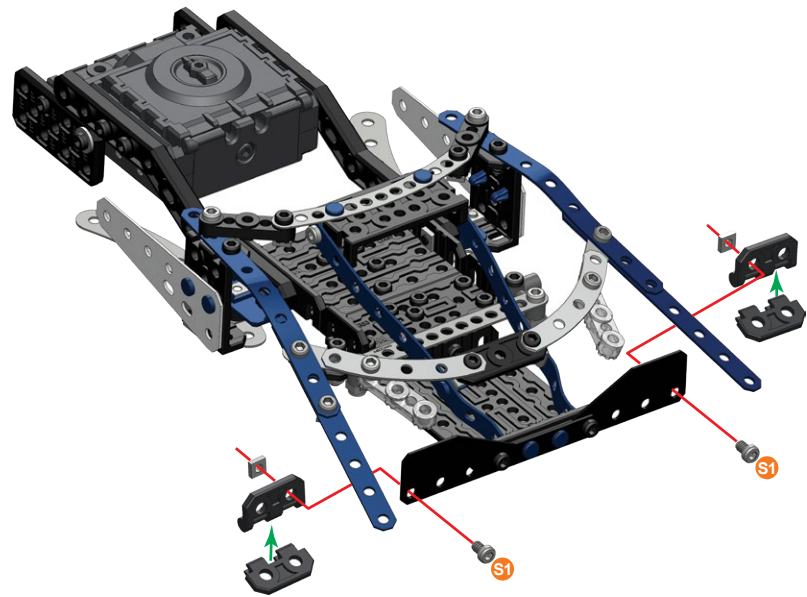
	S1	1:1
---	----	-----





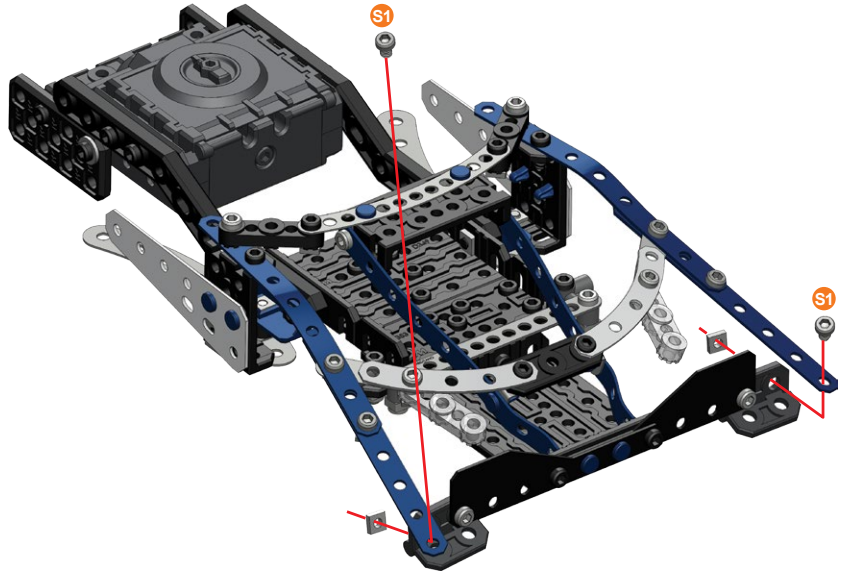

19

	S1	5.8 mm 15/64"	x2
			x2

	S1	1:1
---	----	-----





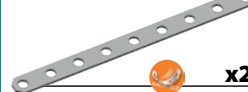

20

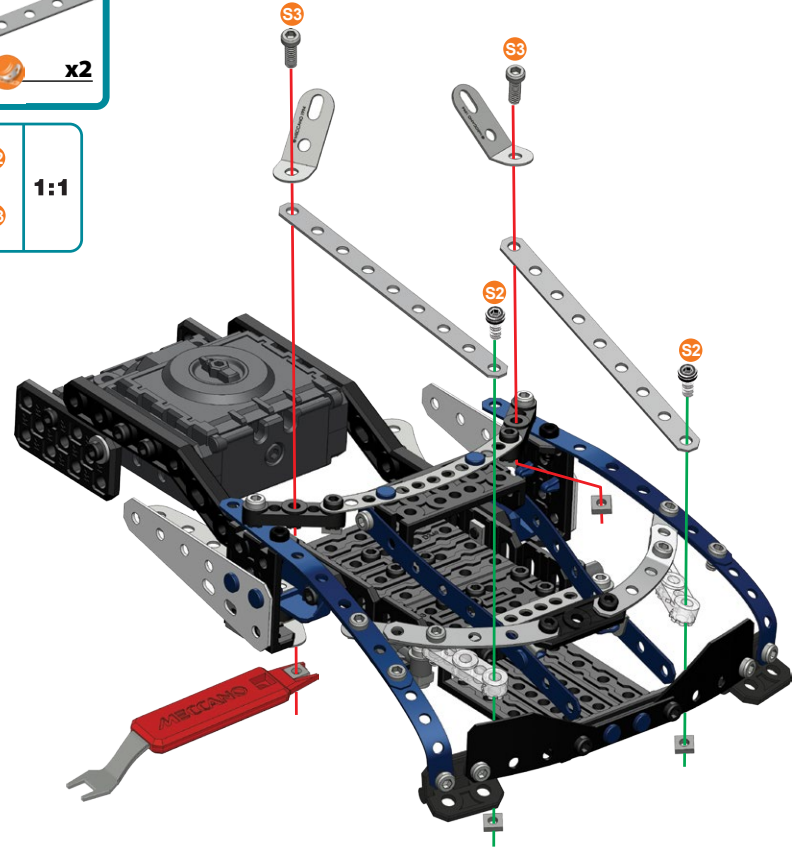
	S2	9.5 mm 3/8"	x2
	S3	12 mm 1/2"	x2
			x4
			x2
			x2



	S2	1:1
	S3	

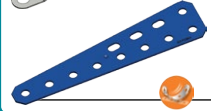

21





-  **S1** | 5.8 mm | **x2**
15/64"
-  **S2** | 9.5 mm | **x2**
3/8"
-  **x4**
-  **x2**
-  **x2**

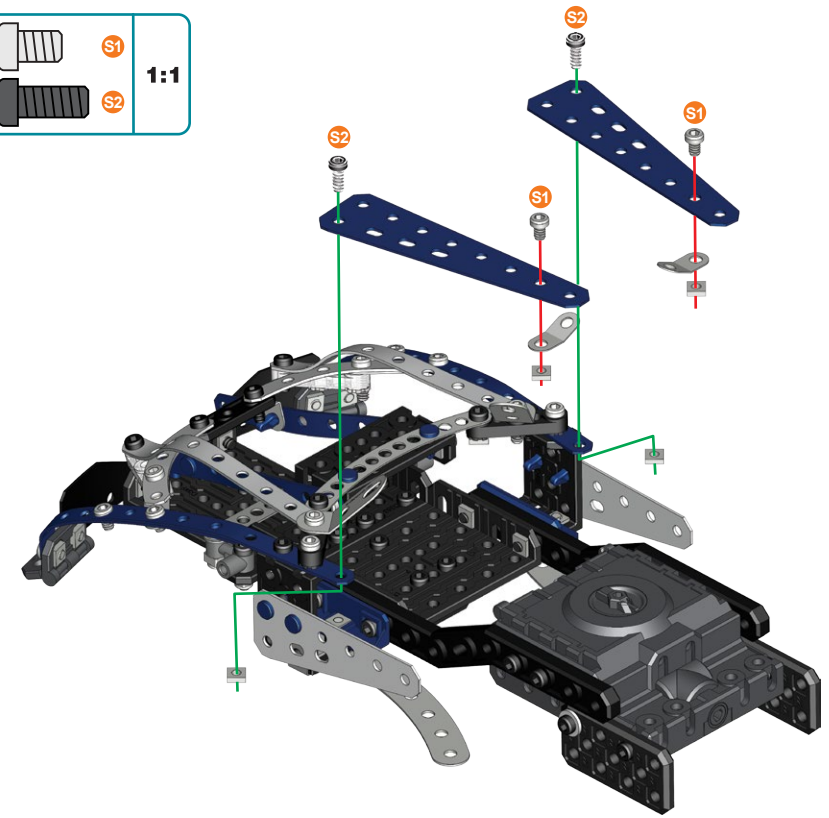



-  **S1**
 -  **S2**
- 1:1**







22

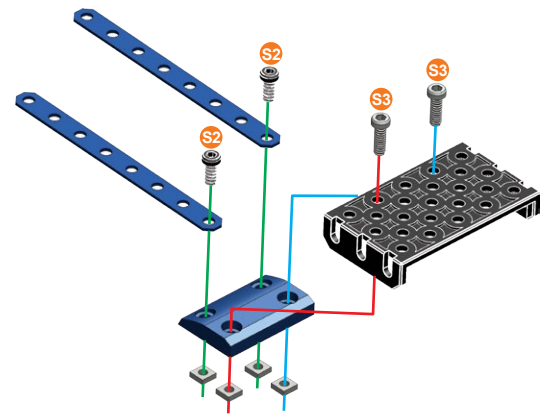

-  **S2** | 9.5 mm | **x2**
3/8"
-  **S3** | 12 mm | **x2**
1/2"
-  **x4**
-  **x1**
-  **x2**

-  **S2**
 -  **S3**
- 1:1**



23

-  **D1** | 11.25 mm | **x2**
7/16"
-  **S1** | 5.8 mm | **x2**
15/64"
-  **x2**
-  **x2**

-  **S1**
 -  **D1**
- 1:1**

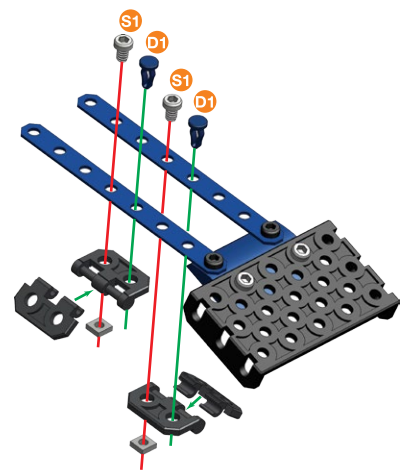

24

	5.8 mm 15/64"	x2
		x2
		x2

	S1	1:1
--	----	-----

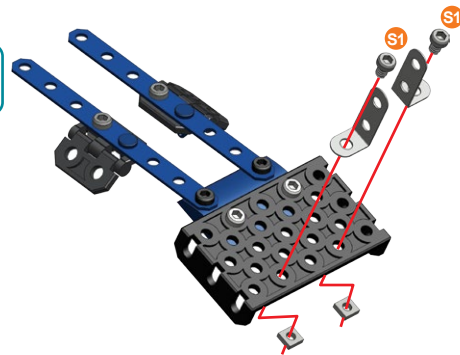

25

	5.8 mm 15/64"	x4
		x4
		x2
		x1

	S1	1:1
--	----	-----

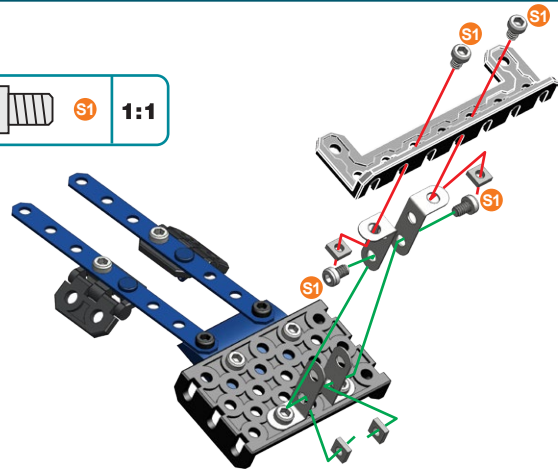

26

	5.8 mm 15/64"	x2
	9.5 mm 3/8"	x2
		x4
		x2
		x2

	S1	1:1
	S2	

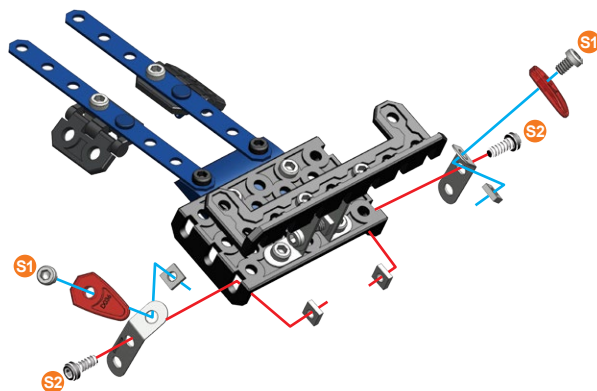

27





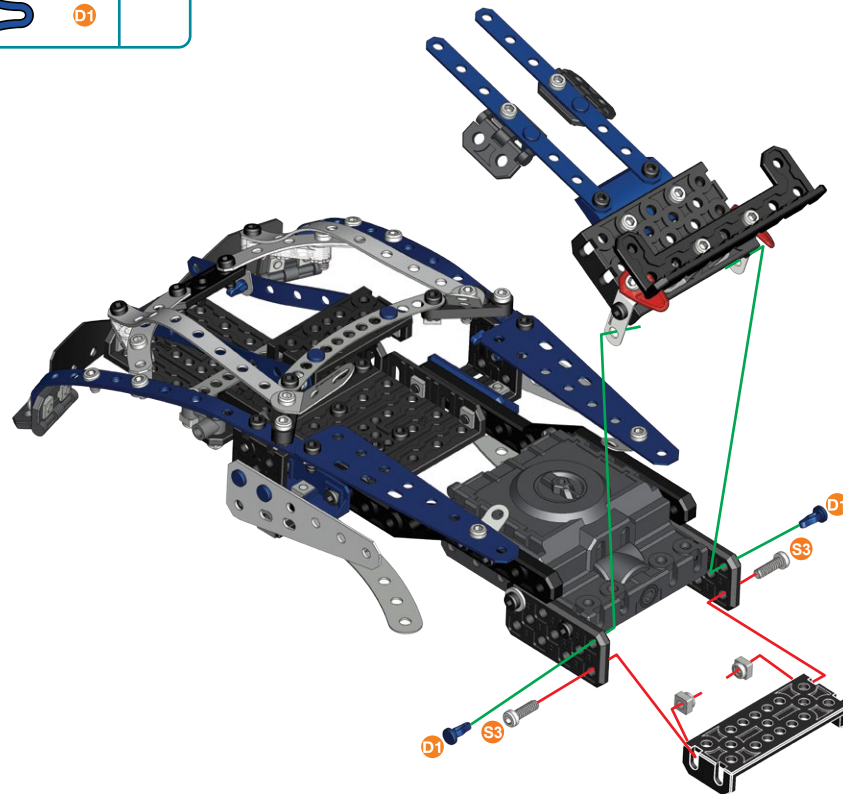

(21)+(26)+

	11.25mm 7/16"	x2
	12 mm 1/2"	x2
		x2
		x1

	S3	1:1
	D1	





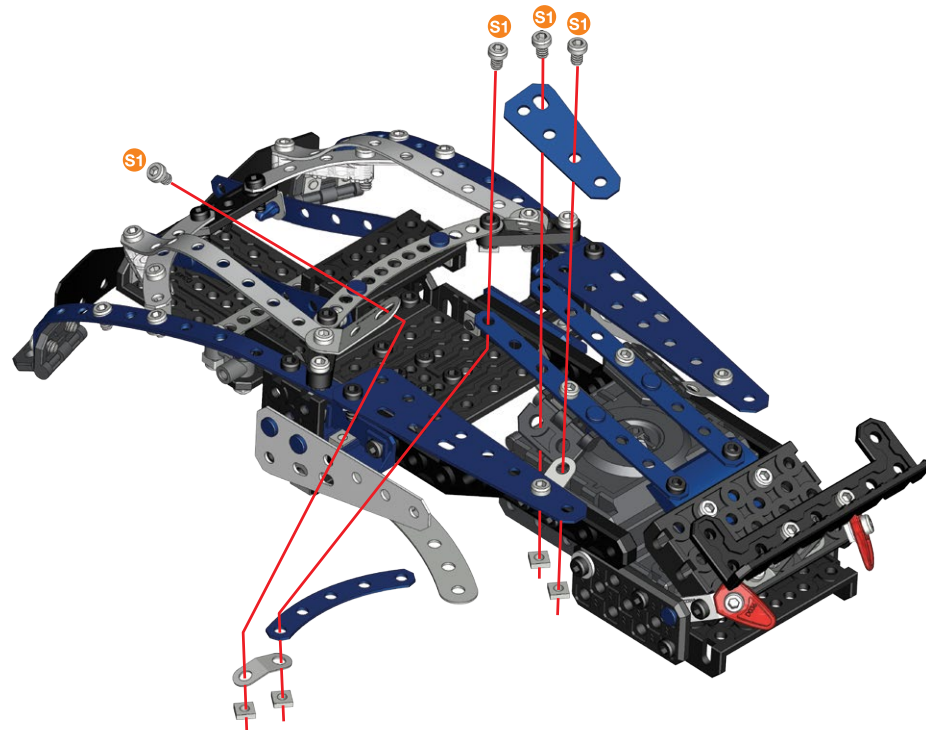

28

	5.8 mm 15/64"	x4
		x4
		x1
		x1
		x1

	S1	1:1
---	----	-----



29

	5.8 mm 15/64"	x4
		x4
		x1
		x1



	S1	1:1
---	----	-----

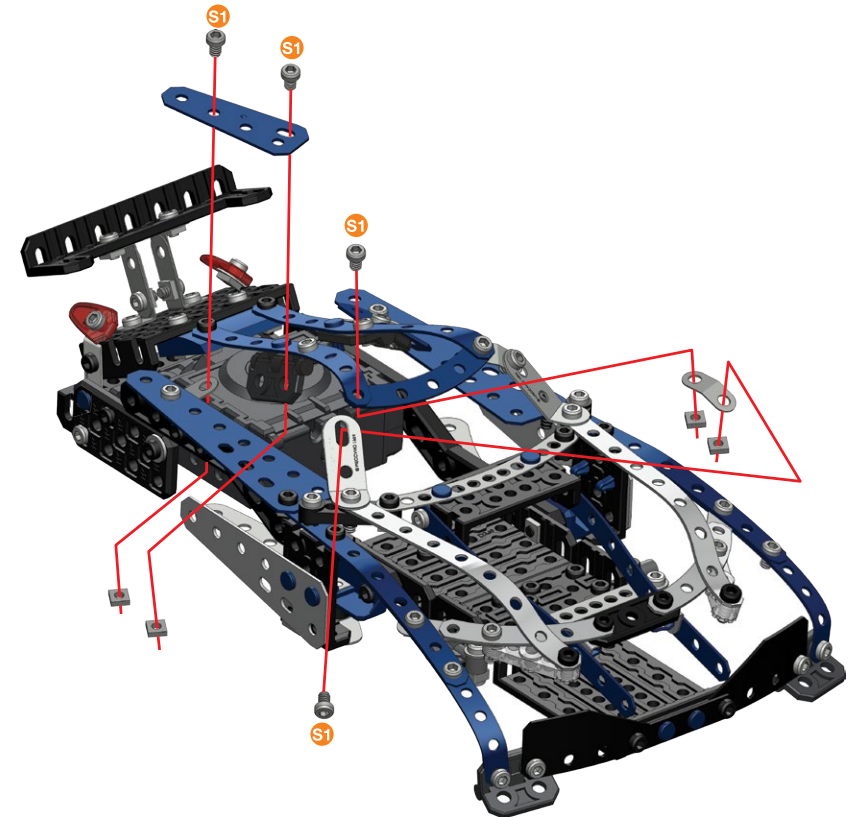

30



31 (29+30)+

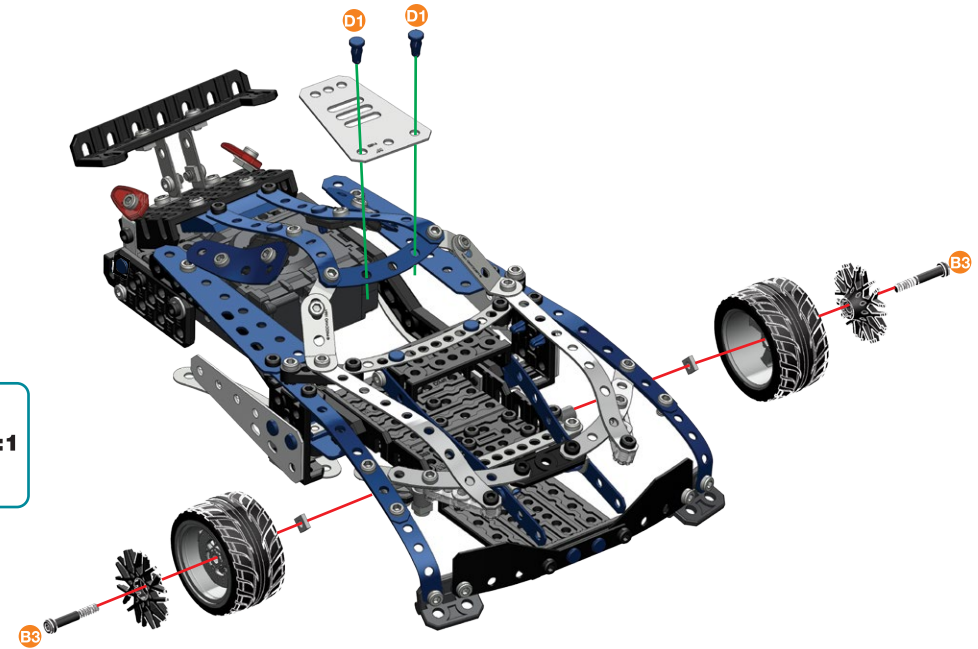
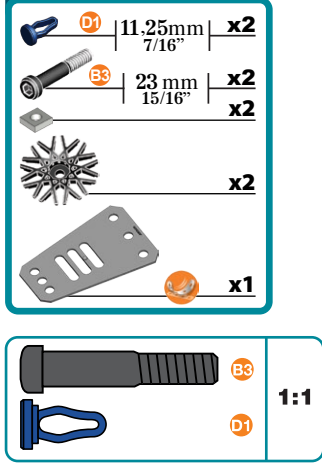

32 (30+31)+

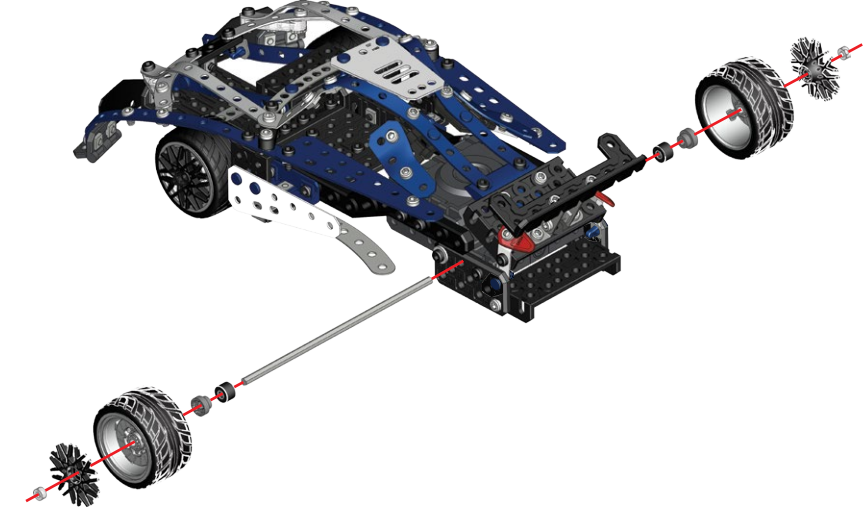
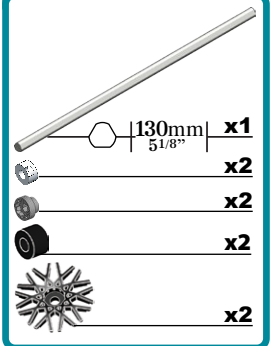

33

- D1 | 11.25mm | x2
7/16"
- S1 | 5.8 mm | x2
15/64"
- | x2
- | x2
- | x2

