







1

	x4
	x4
	x4

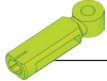
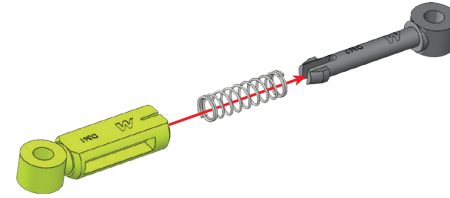
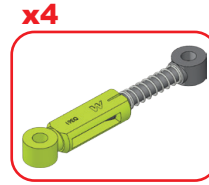





2

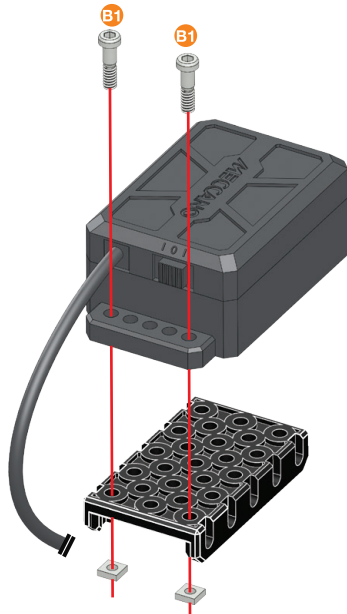
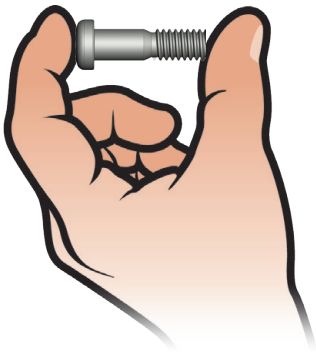

	14.7 mm 37/64 in 37/64 po	x2
		x2
		x1
		x1

 **B1** 1:1



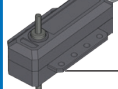

3 ①+

	5.8 mm 15/64 in 15/64 po	x4
	14.7 mm 37/64 in 37/64 po	x2
		x6
		x2
		x4
		x1

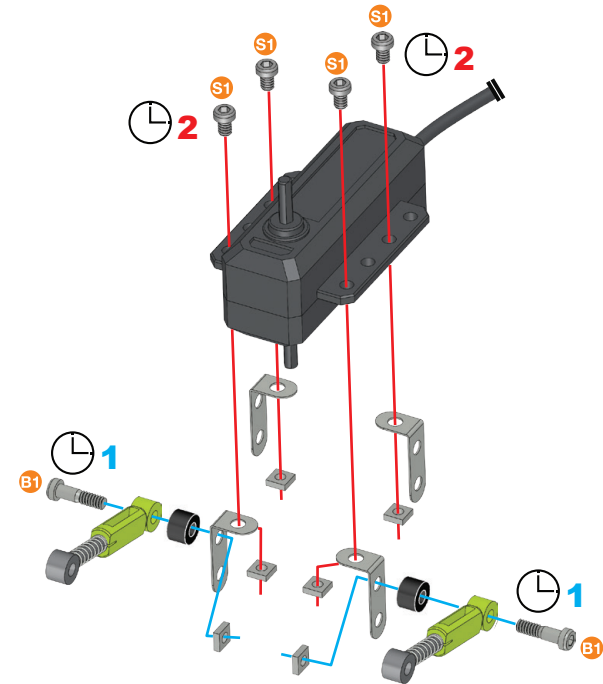
	S1	1:1
	B1	
	A238	



4

	9.5 mm 3/8 in 3/8 po	x4
		x4
		x2



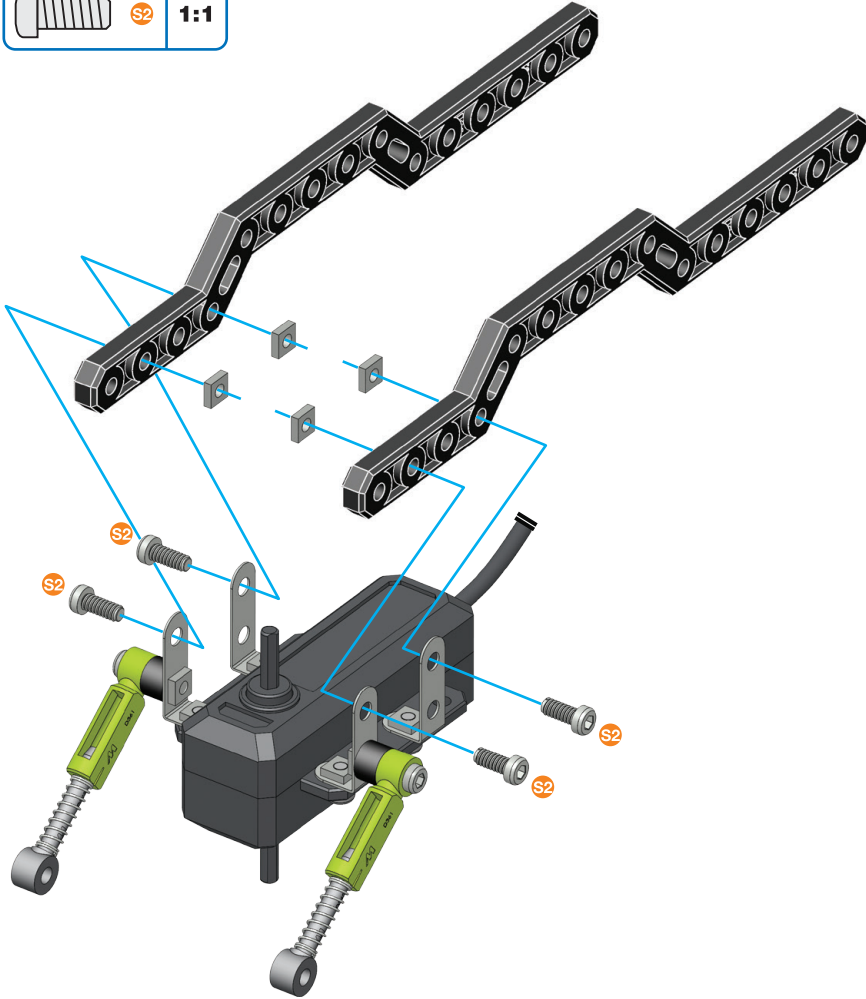

	S2	1:1
--	----	-----



5



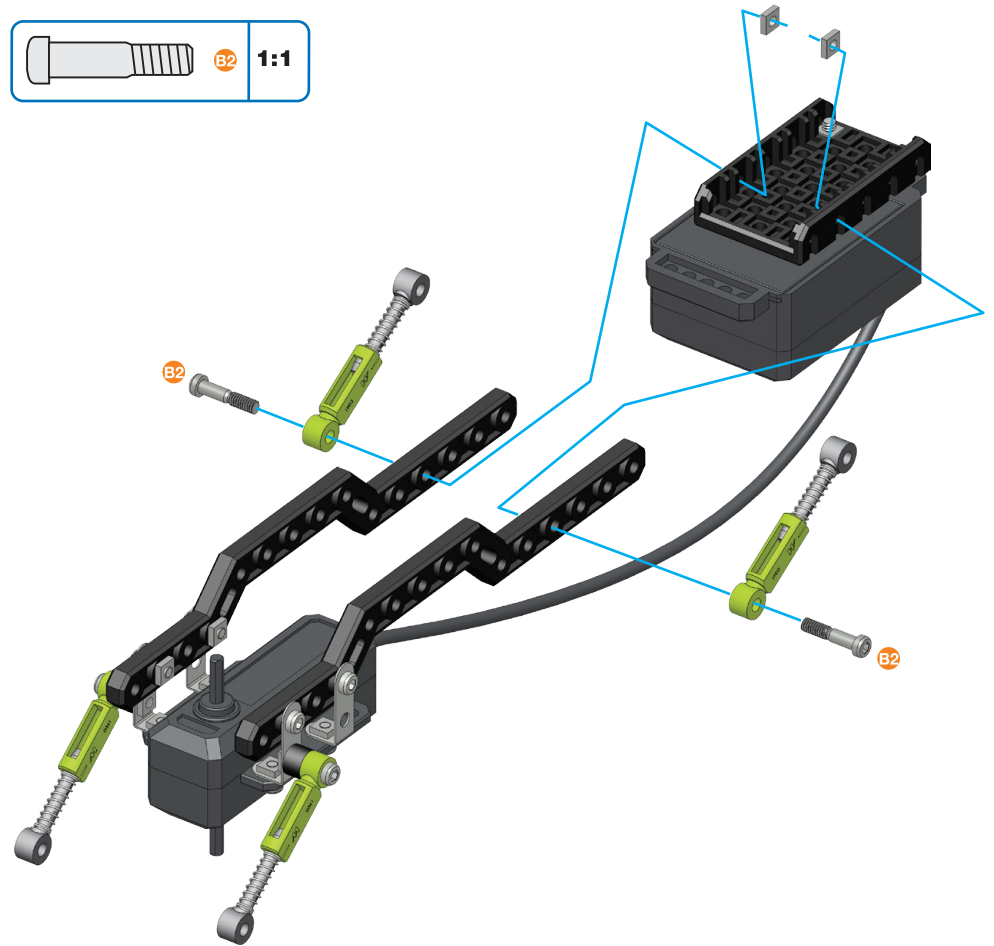

①+②+④+

	19 mm 3/4 in 3/4 po	x2
		x2

	B2	1:1
---	----	-----







6

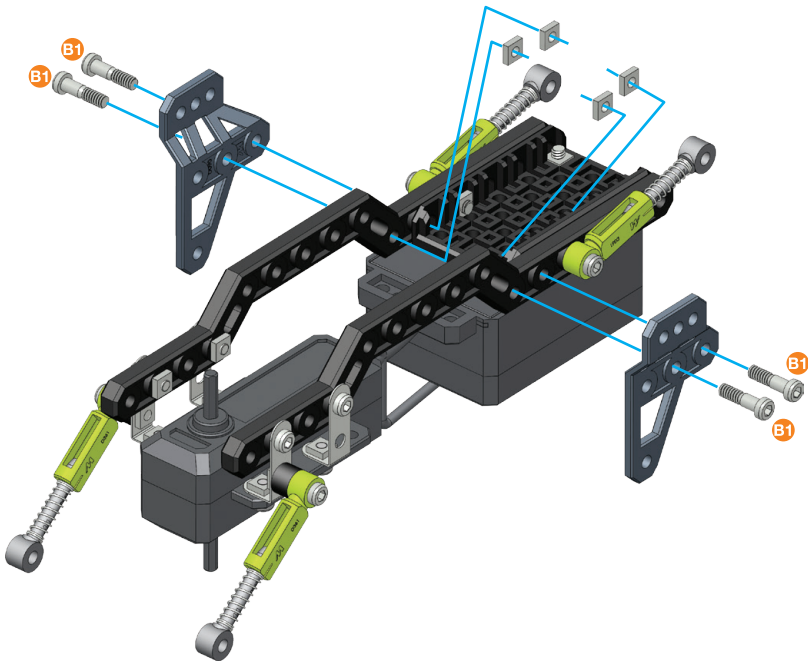

-  14,7 mm | 37/64 in | 37/64 po | **x4**
-  **x4**
-  **x1**
-  **x1**

-  **1:1**

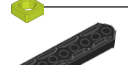

7

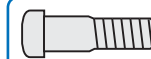
-  9,5 mm | 3/8 in | 3/8 po | **x2**
-  14,7 mm | 37/64 in | 37/64 po | **x2**
-  **x4**
-  **x2**
-  **x2**

-  **B1**
-  **S2**
-  **D277**
- 1:1**

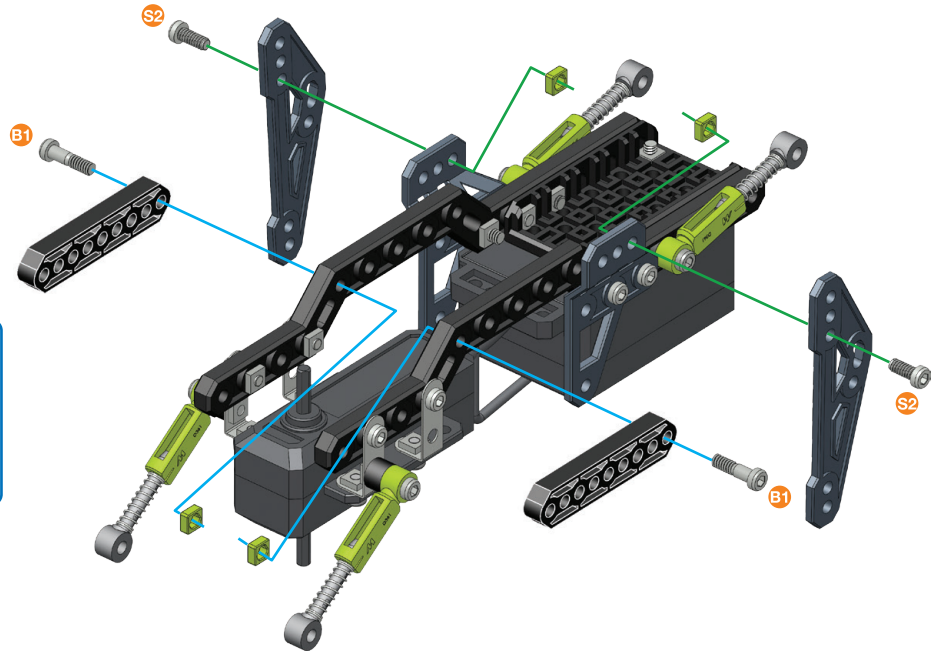

8

-  **x1**
-  **x1**

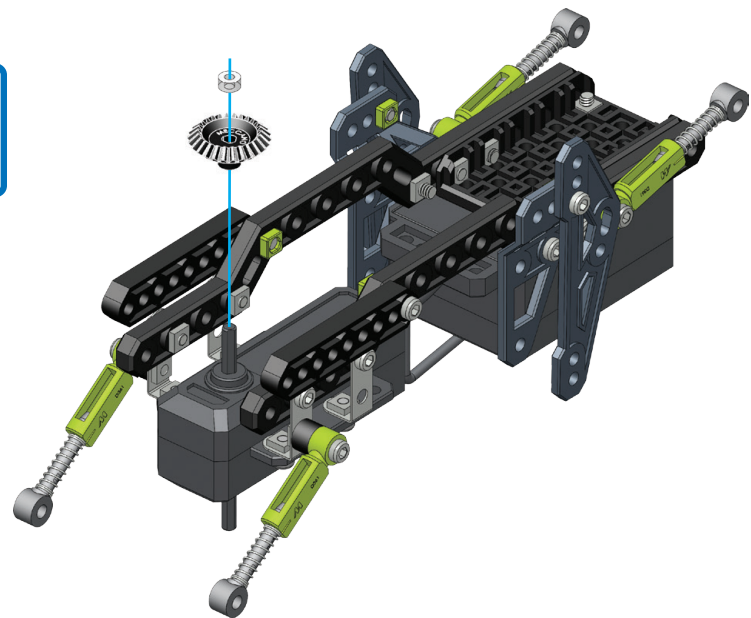

9

- 5.8 mm | 15/64 in | 15/64 po | **x2**
- x4**
- x2**
- x2**

- 1:1**

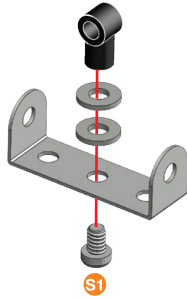

x2

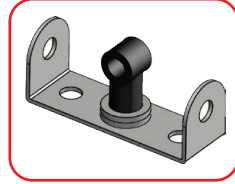

10

9+

- 60 mm | 2 3/8 in | 2 3/8 po | **x1**
- 75 mm | 2 15/16 in | 2 15/16 po | **x1**
- x1**
- x3**
- x1**
- x1**
- x1**
- x2**
- x1**

- A338**
- A238**
- 1:1**

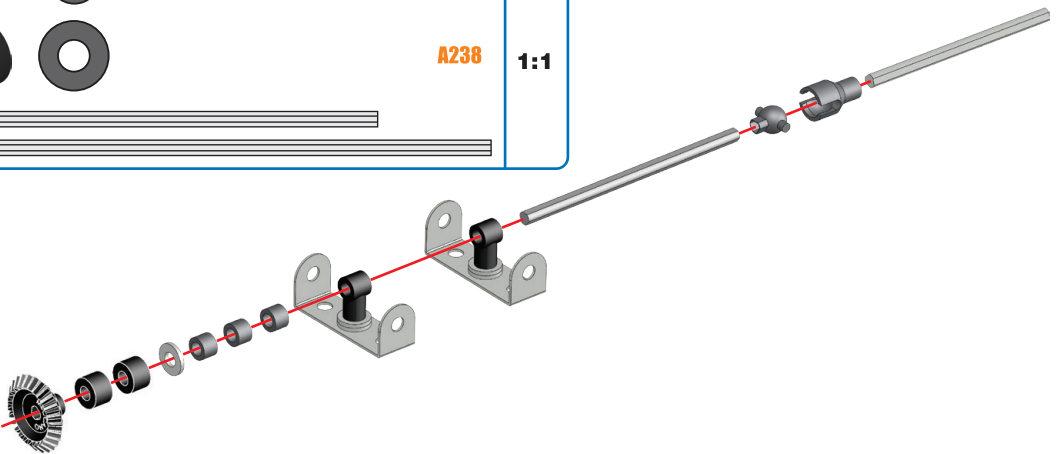

11

8+10+

- 9.5 mm | 3/8 in | 3/8 po | **x4**
- x4**

- 1:1**

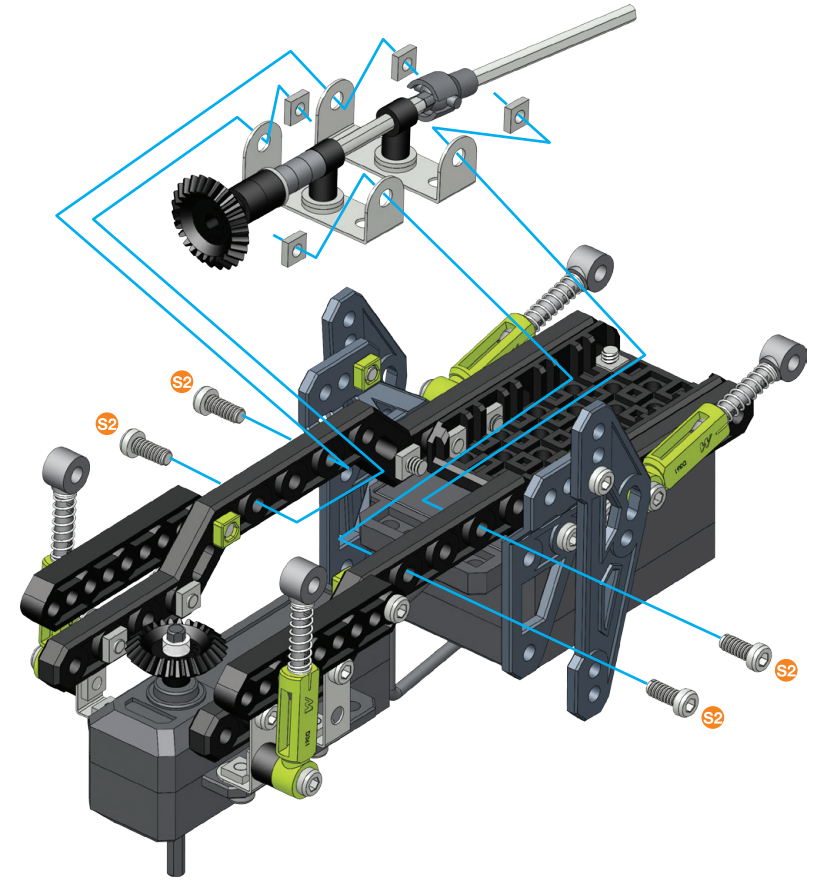

12

	S2	9.5 mm 3/8 in 3/8 po	x2
			x2
			x2



	S2	1:1
--	----	-----

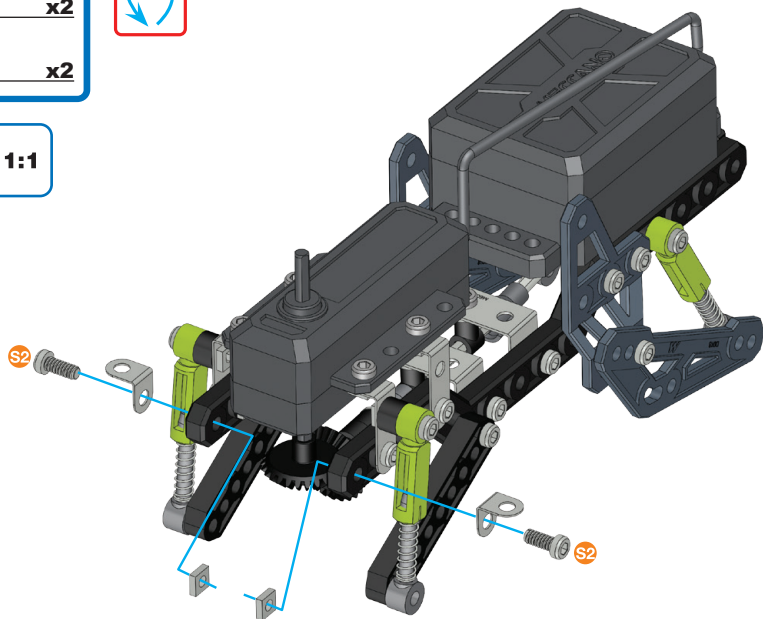

13

	S1	5.8 mm 15/64 in 15/64 po	x1
	S2	9.5 mm 3/8 in 3/8 po	x1
	S3	12 mm 1/2 in 1/2 po	x1
			x3
			x1
			x1
			x1
			x1
			x1

	S1	1:1
	S2	
	S3	
		A238

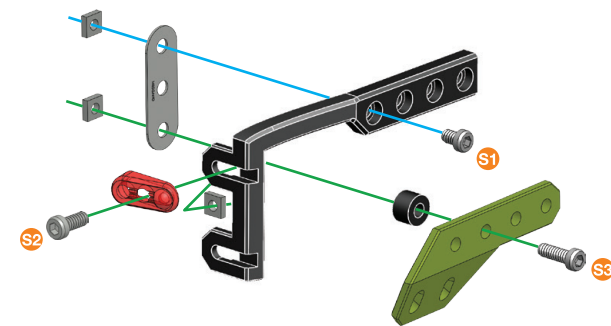

14

	S2	9.5 mm 3/8 in 3/8 po	x2
			x2
			x1
			x1

	S2	1:1
--	----	-----

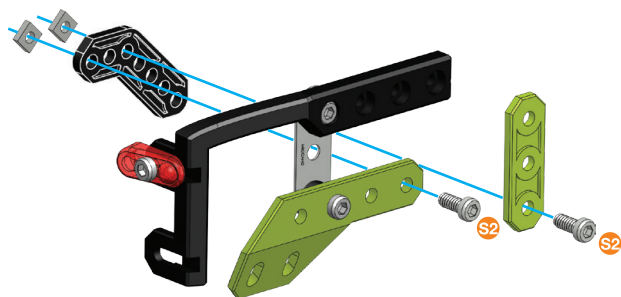





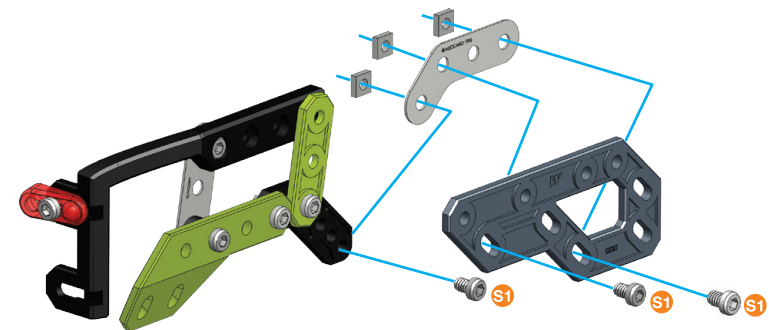

15

	S1	5.8 mm 15/64 in 15/64 po	x3
			x3
			x1
			x1

	S1	1:1
--	----	-----







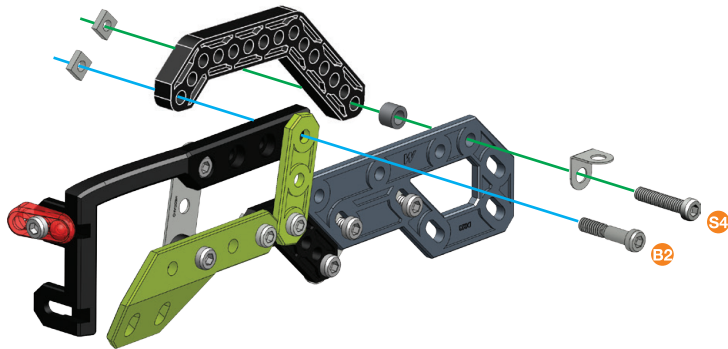

16



-  19 mm | 3/4 in | 3/4 po | **x1**
-  19 mm | 3/4 in | 3/4 po | **x1**
-  | **x2**
-  | **x1**
-  | **x1**
-  | **x1**

- | | | |
|--|-------------|------------|
|  | B2 | 1:1 |
|  | S4 | |
|  | A338 | |









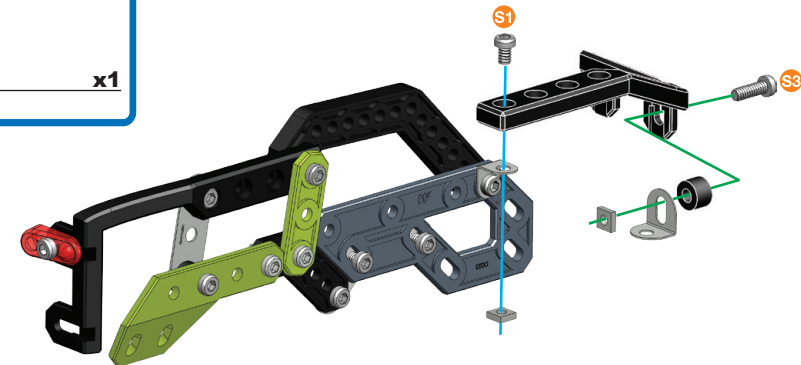

17





-  5.8 mm | 15/64 in | 15/64 po | **x1**
-  12 mm | 1/2 in | 1/2 po | **x1**
-  | **x2**
-  | **x1**
-  | **x1**
-  | **x1**

- | | | |
|---|-------------|------------|
|  | S1 | 1:1 |
|  | S3 | |
|  | A238 | |





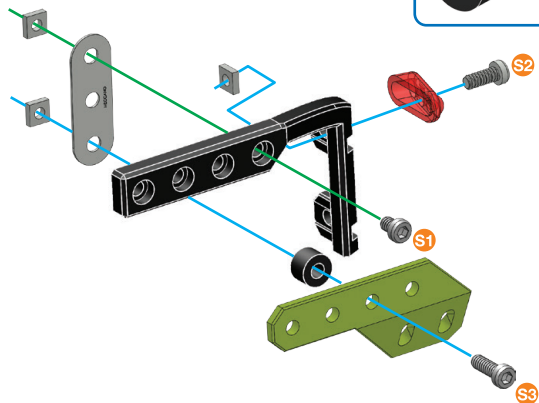

18

-  5.8 mm | 15/64 in | 15/64 po | **x1**
-  9.5 mm | 3/8 in | 3/8 po | **x1**
-  12 mm | 1/2 in | 1/2 po | **x1**
-  | **x3**
-  | **x1**
-  | **x1**
-  | **x1**
-  | **x1**
-  | **x1**

- | | | |
|---|-------------|------------|
|  | S1 | 1:1 |
|  | S2 | |
|  | S3 | |
|  | A238 | |





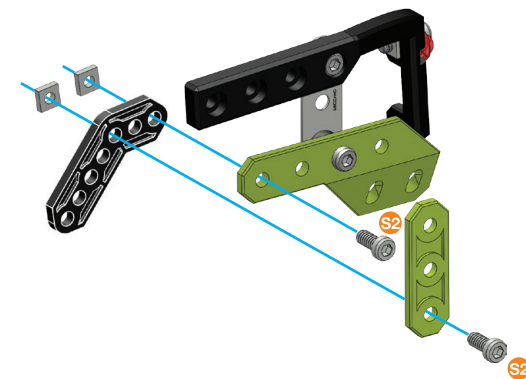

19

-  9.5 mm | 3/8 in | 3/8 po | **x2**
-  | **x2**
-  | **x1**
-  | **x1**

- | | | |
|---|-----------|------------|
|  | S2 | 1:1 |
|---|-----------|------------|







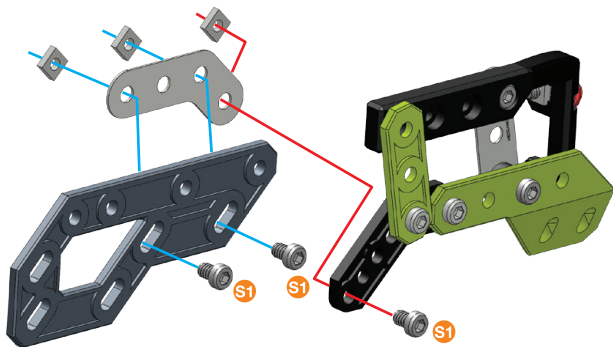

20

	5,8 mm 15/64 in 15/64 po	x3
		x3
		x1
		x1







	S1	1:1
--	-----------	------------

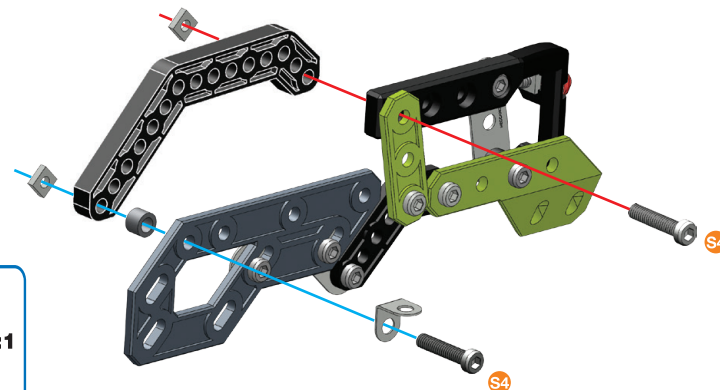

**21**

	19 mm 3/4 in 3/4 po	x2
		x2
		x1
		x1
		x1







	S4	1:1
	A338	

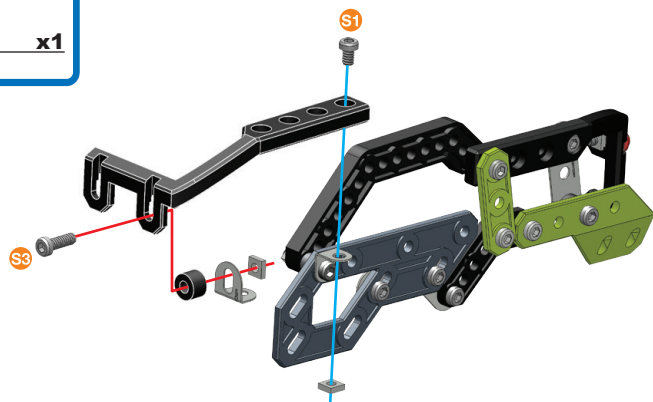

**22**

	5,8 mm 15/64 in 15/64 po	x1
	12 mm 1/2 in 1/2 po	x1
		x2
		x1
		x1
		x1

	S1	1:1
	S3	
	A238	

**23****(17)+(22)+**



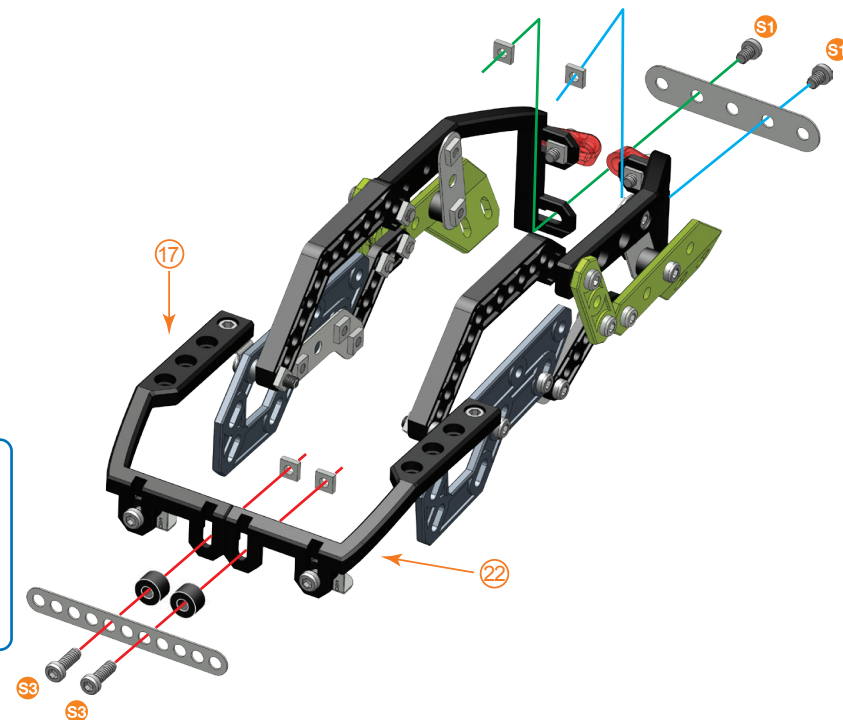

	5,8 mm 15/64 in 15/64 po	x2
	12 mm 1/2 in 1/2 po	x2
		x4
		x2
		x1
		x1



	S1	1:1
	S3	
	A238	



24



12+23+

	5.8 mm 15/64 in	x2
	14.7 mm 37/64 in	x2
		x4
		x2

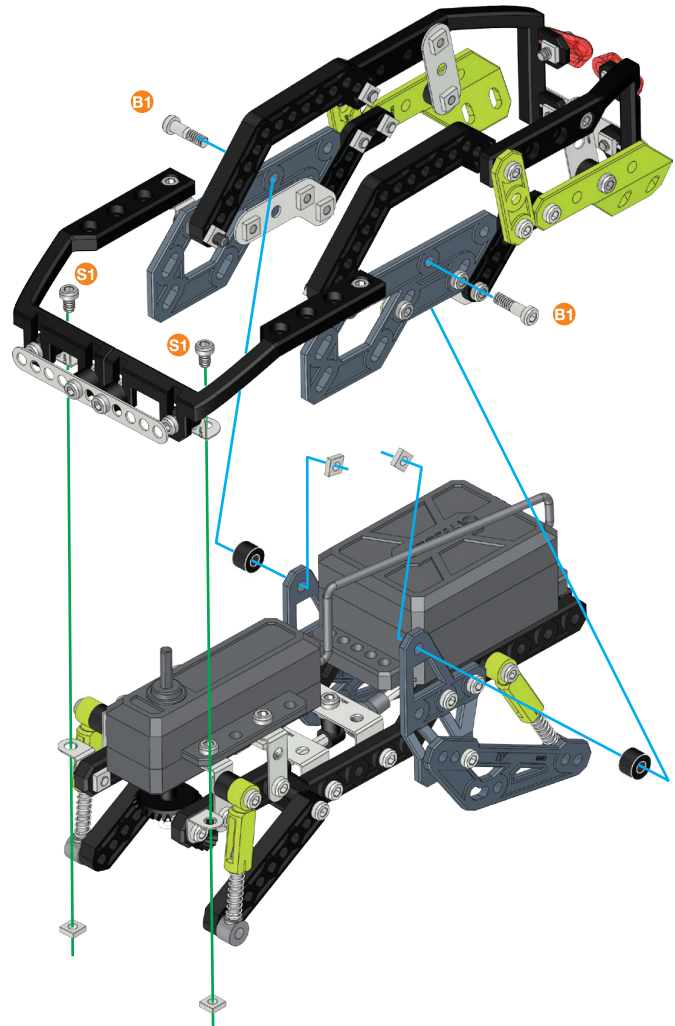
	S1	1:1
	B1	
	A238	







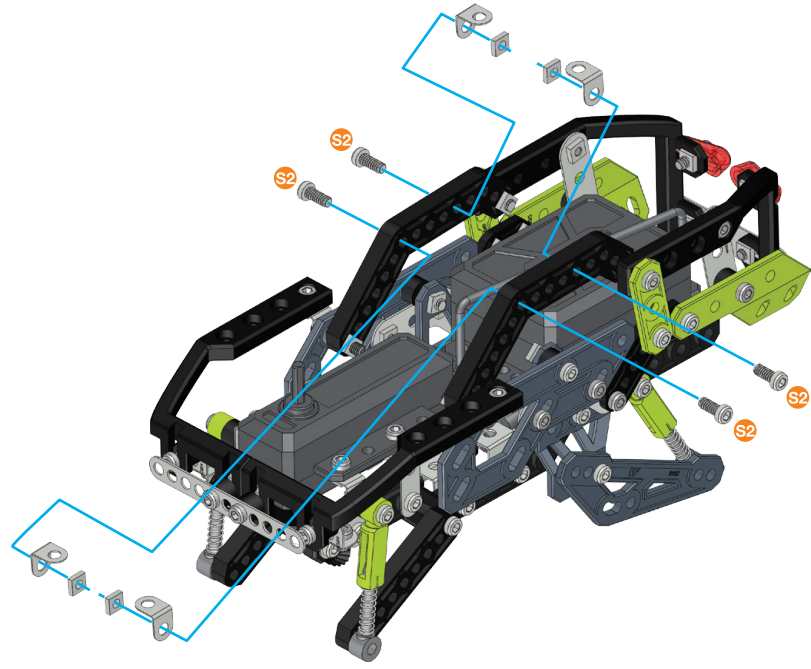

25

	9.5 mm 3/8 in	x4
		x4
		x4

	S2	1:1
---	-----------	------------







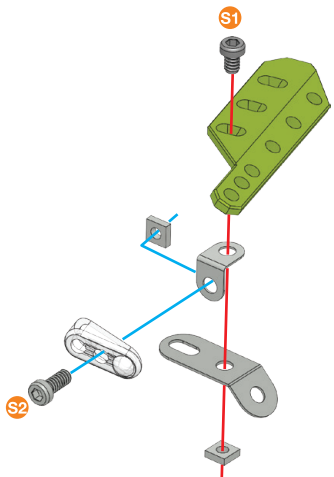

26

-  5.8 mm | 15/64 in | 15/64 po | **x1**
-  9.5 mm | 3/8 in | 3/8 po | **x1**
-  **x2**
-  **x1**
-  **x1**
-  **x1**
-  **x1**

-  **S1** | **1:1**
-  **S2** | **1:1**



27

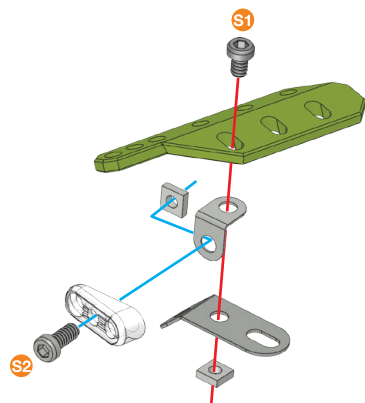

-  5.8 mm | 15/64 in | 15/64 po | **x1**
-  9.5 mm | 3/8 in | 3/8 po | **x1**
-  **x2**
-  **x1**
-  **x1**
-  **x1**
-  **x1**

-  **S1** | **1:1**
-  **S2** | **1:1**



28



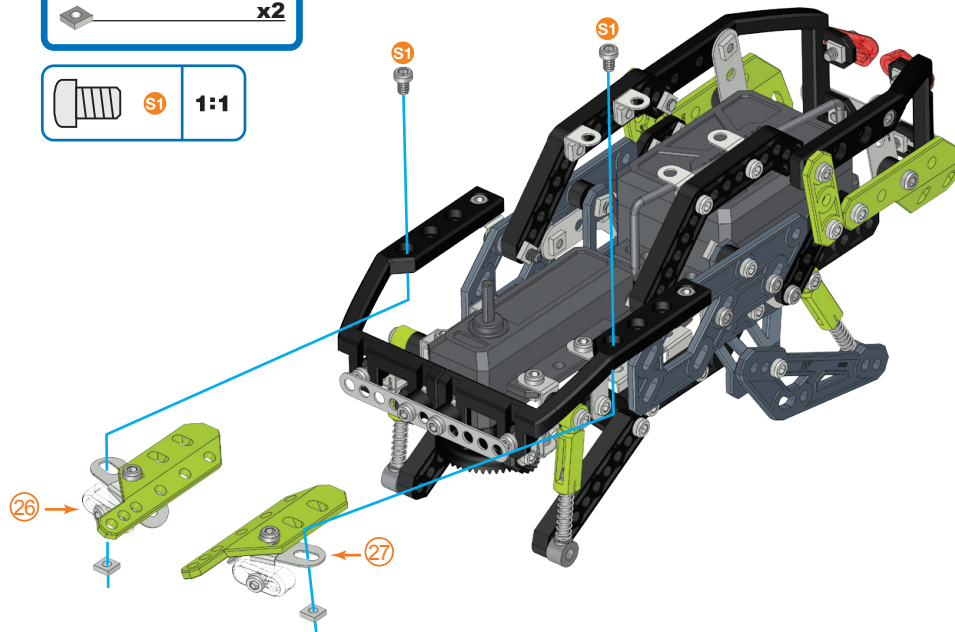

(25)+(26)+(27)+

-  5.8 mm | 15/64 in | 15/64 po | **x2**
-  **x2**

-  **S1** | **1:1**





29

-  5.8 mm | 15/64 in | 15/64 po | **x2**
-  **x2**
-  **x1**
-  **x2**

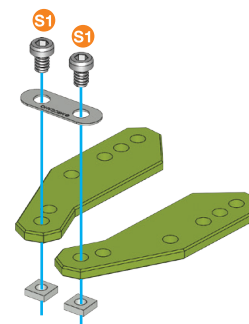
-  **S1** | **1:1**





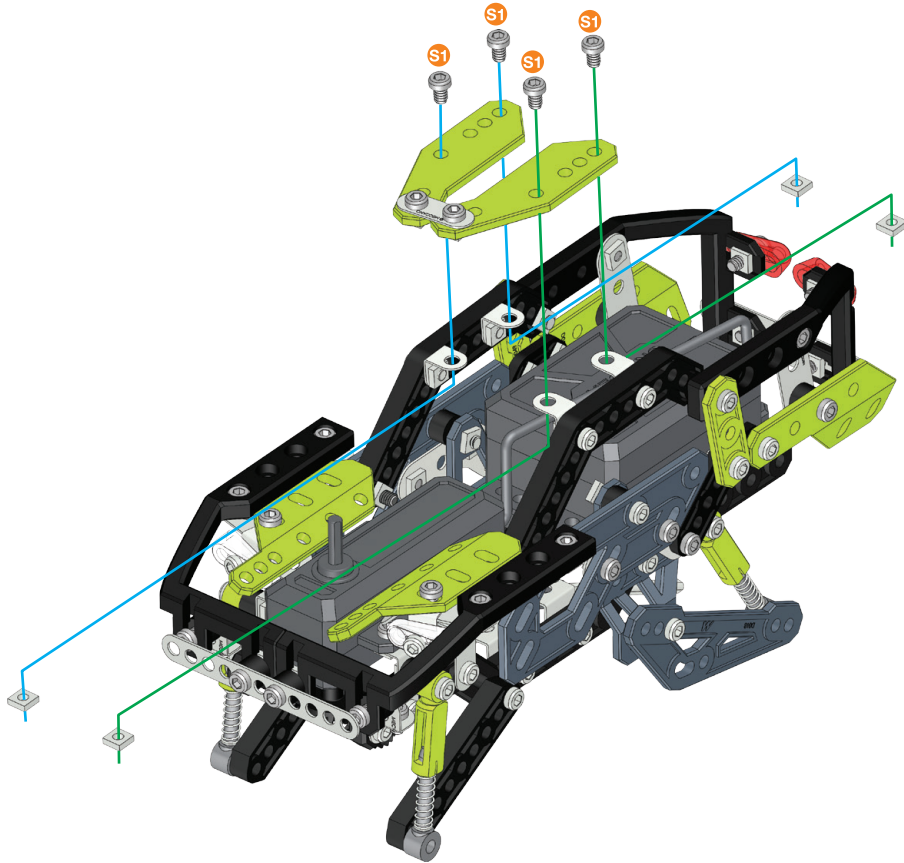

30**(28)+(29)+**

	5.8 mm 15/64 in 15/64 po	x4
		x4

	S1	1:1
---	-----------	------------

**31**

	5.8 mm 15/64 in 15/64 po	x4
		x4
		x2
		x2

	S1	1:1
---	-----------	------------

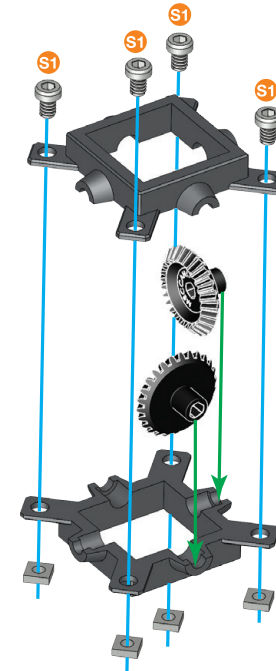

32

30+31+

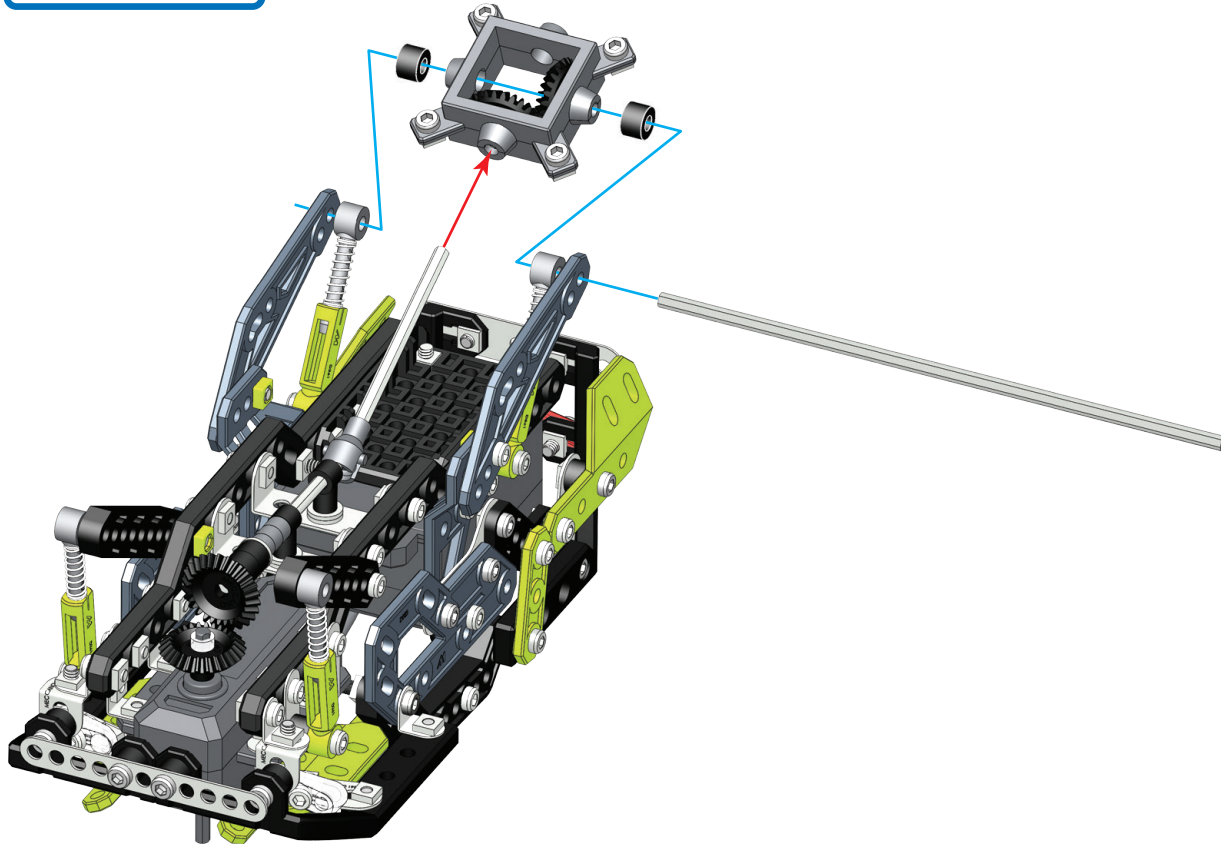
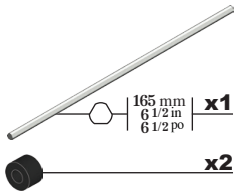

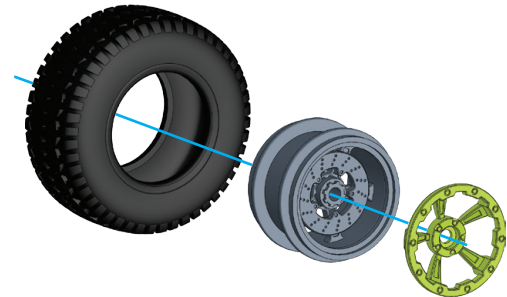
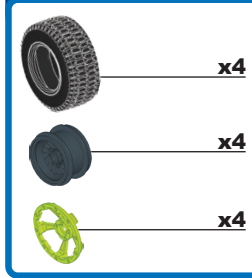

33



34

32+33+

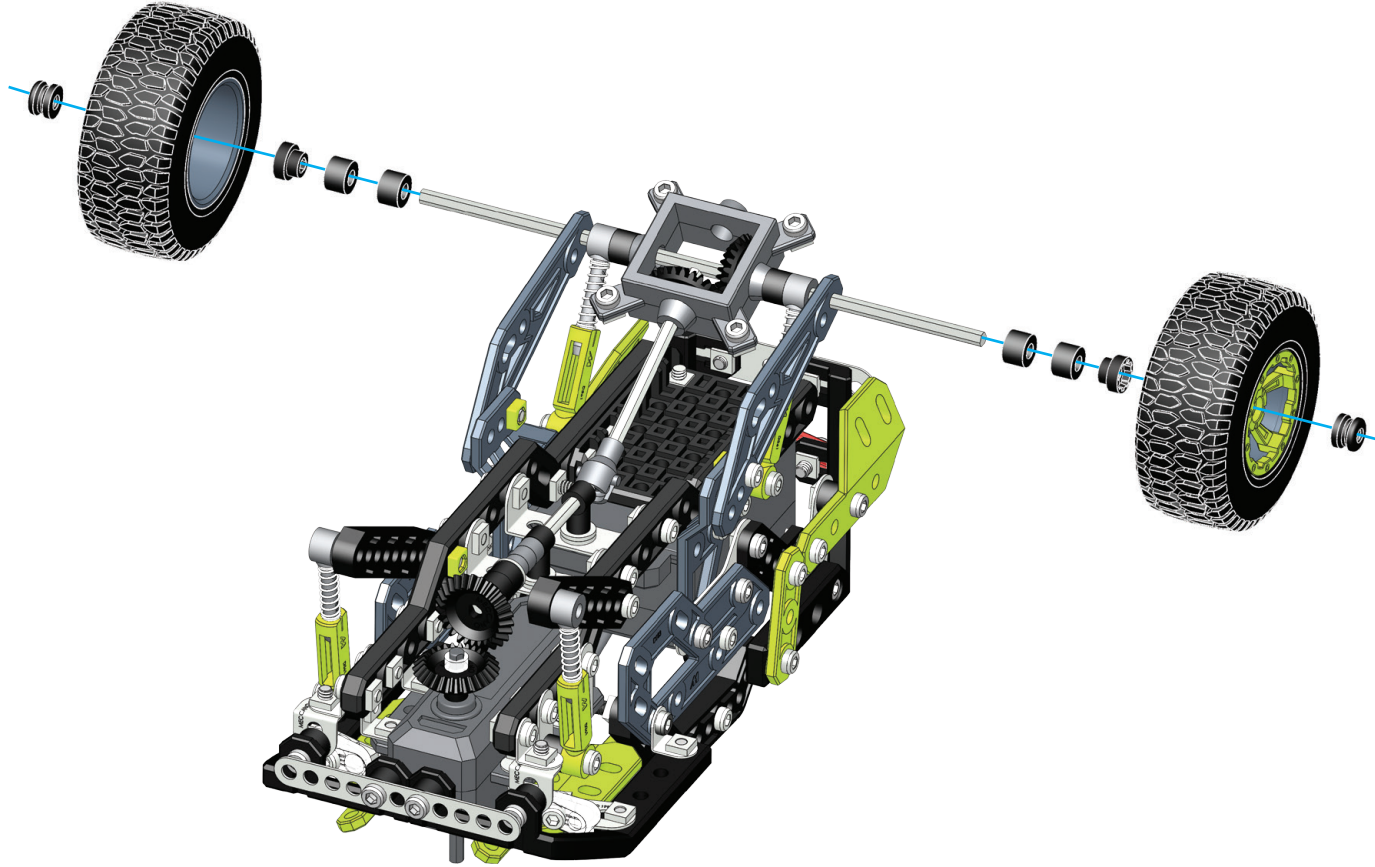

-  x4
-  x2
-  x2

		A238	1:1
--	---	------	-----



35

(33)+(34)+

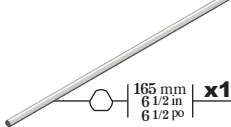
-  **x3**
-  **x2**
-  **x7**
-  **x1**
165 mm
6 1/2 in
6 1/2 po

