









1

	5.8 mm 15/64 in 15/64 po	x4
		x4
		x2
		x2
		x2
		x1

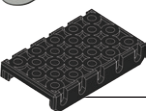
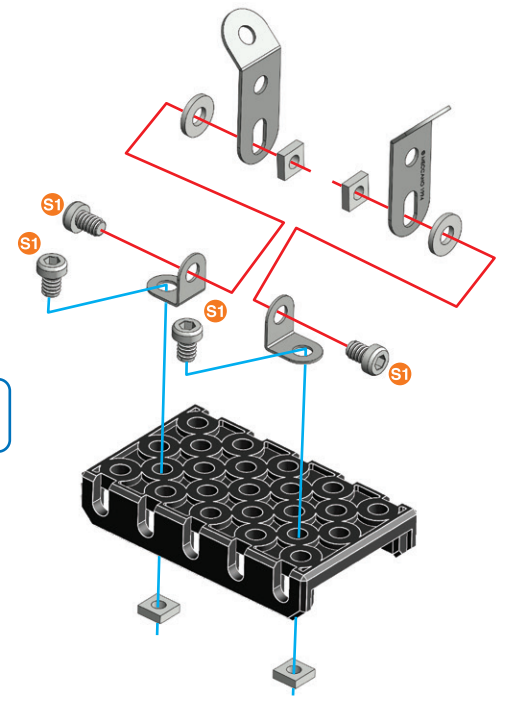
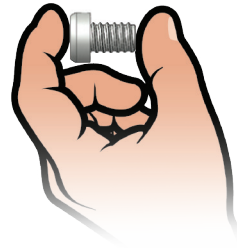
	S1	1:1
---	----	-----





2

	5.8 mm 15/64 in 15/64 po	x2
		x2
		x1
		x1

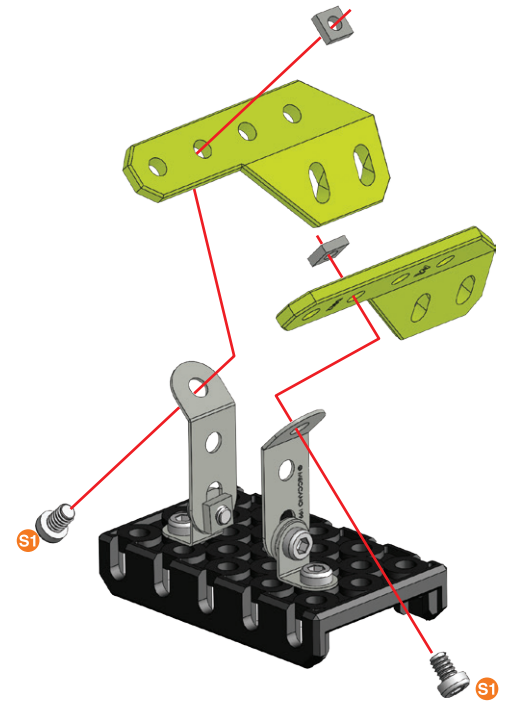
	S1	1:1
---	----	-----



3

	5.8 mm 15/64 in 15/64 po	x4
		x4
		x4

	S1	1:1
---	----	-----

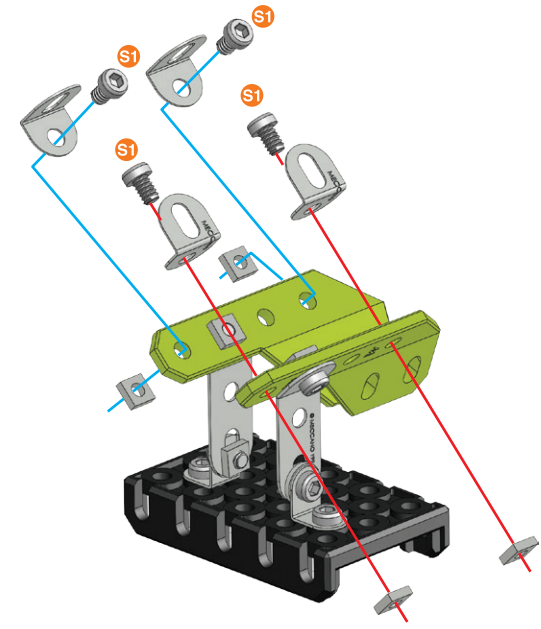

4

- 60 mm | 2 3/8 in | 2 3/8 po | **x1**
- x4**
- x1**
- x2**
- x2**
- x1**
- x1**

- A238**
- A338**
- 1:1**

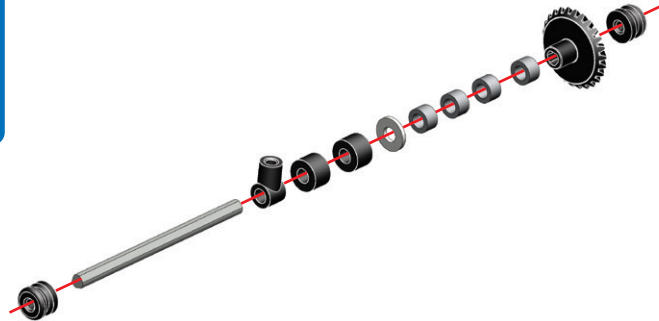

- 1:1**

5

- B2** | 19 mm | 3/4 in | 3/4 po | **x1**
- x2**
- x2**
- x1**

- A238**
- B2**
- 1:1**

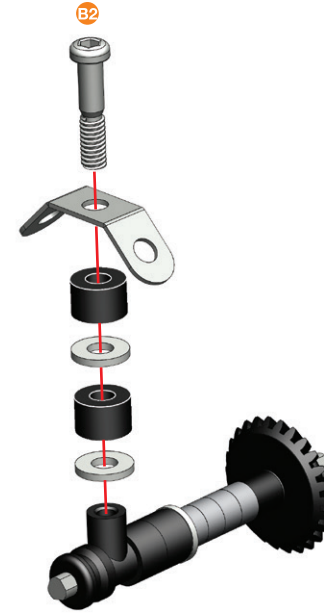

6

- S2** | 9.5 mm | 3/8 in | 3/8 po | **x4**
- x4**
- x4**
- x2**

- S2**
- 1:1**

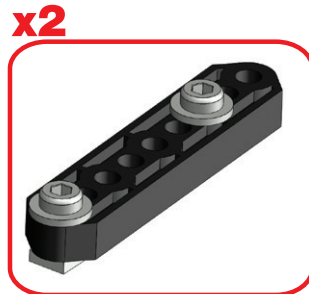
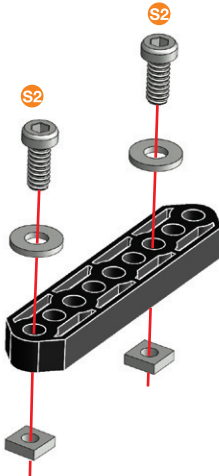

7



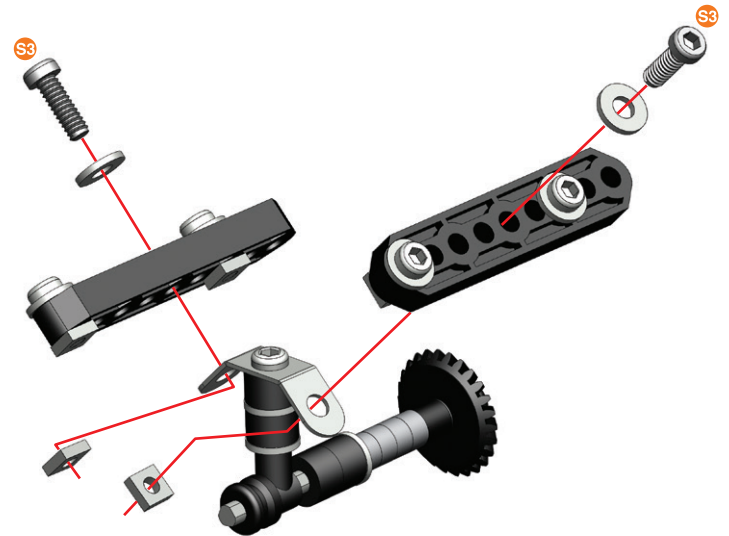

⑤ + ⑥ +

- S3** | 12 mm | 1/2 in | 1/2 po | **x2**
- x2**
- x2**

- S3**
- 1:1**





8**③+⑦+**

	12 mm 1/2 in 1/2 po	x4
		x4
		x4
		x1

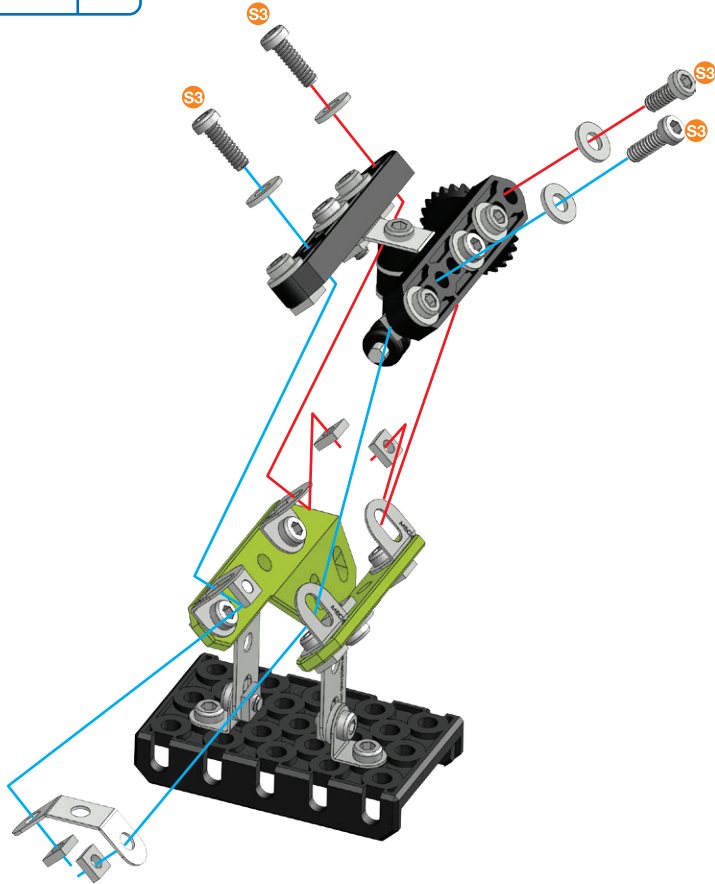

	S3	1:1
--	-----------	------------

**9**

	5.8 mm 15/64 in 15/64 po	x1
		x1
		x2

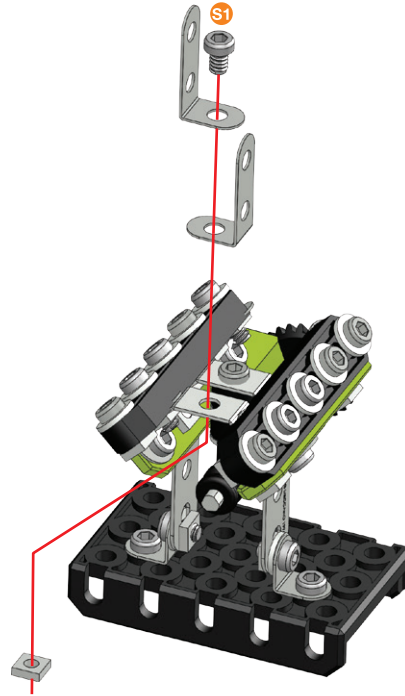
	S1	1:1
--	-----------	------------

**10**

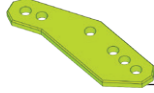
	5.8 mm 15/64 in 15/64 po	x2
		x2
		x2

	S1	1:1
--	-----------	------------

