

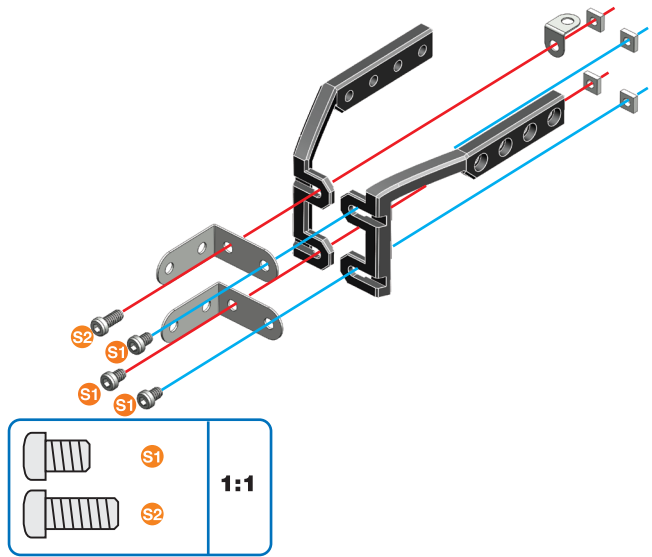

1

- 9.5 mm **x1**
3/8 in
3/8 po
- 5.8 mm **x3**
15/64 in
15/64 po
- x4**
- x2**
- x1**
- x1**
- x1**
- x1**



	S1	1:1
	S2	

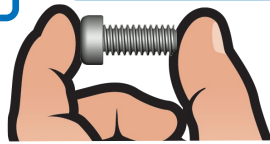

2





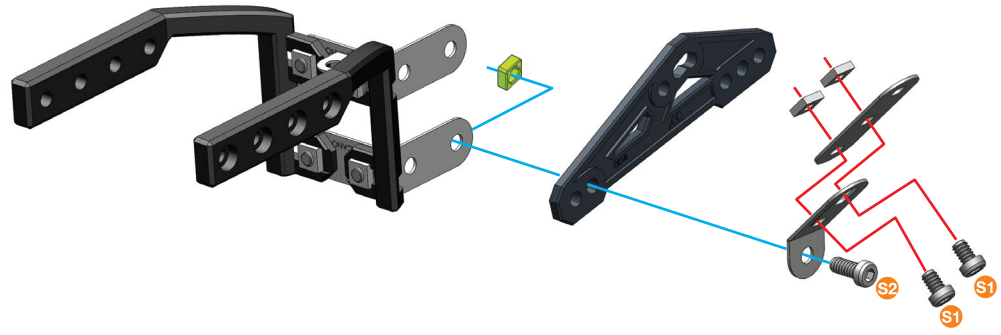

- 9.5 mm **x1**
3/8 in
3/8 po
- 5.8 mm **x2**
15/64 in
15/64 po
- x2**
- x1**
- x1**
- x1**
- x1**





	S1	1:1
	S2	
	D277	





3

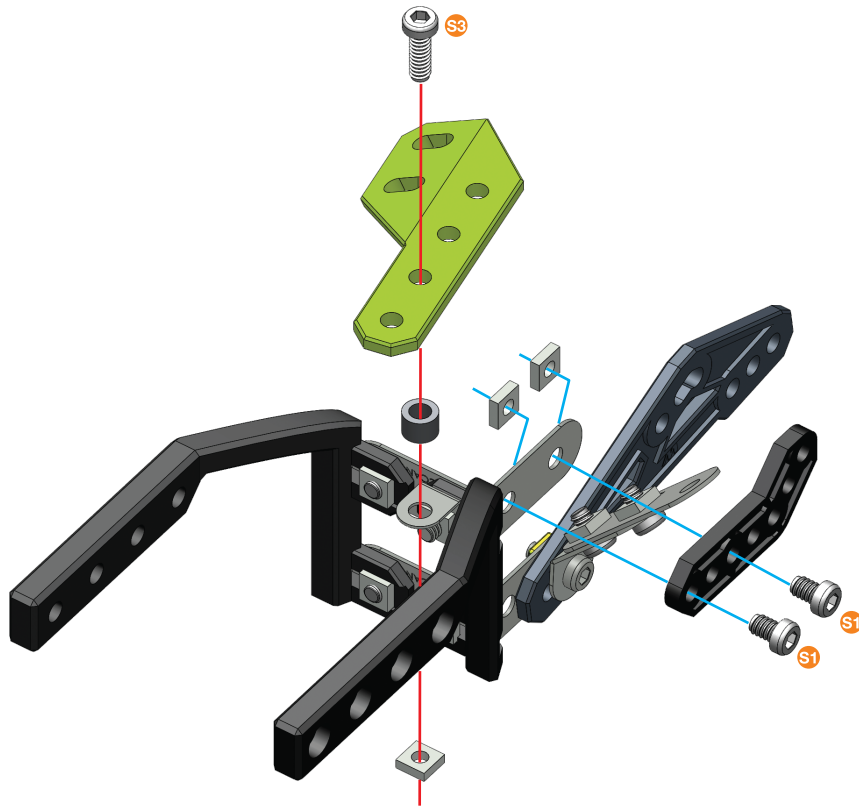

	12 mm 1/2 in 1/2 po	x1
	5.8 mm 15/64 in 15/64 po	x2
		x3
		x1
		x1
		x1

	S1	1:1
	S3	
	A338	

**4**

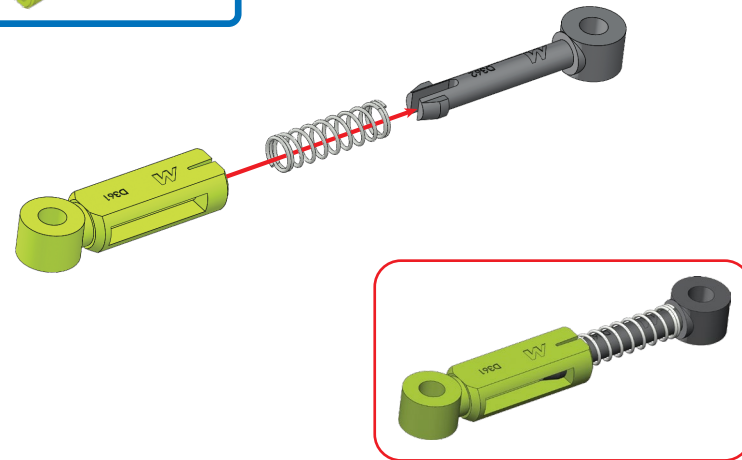
	x1
	x1
	x1



**5****(3)+(4)+**

	14.7 mm 37/64 in 37/64 po	x2
		x2
		x2

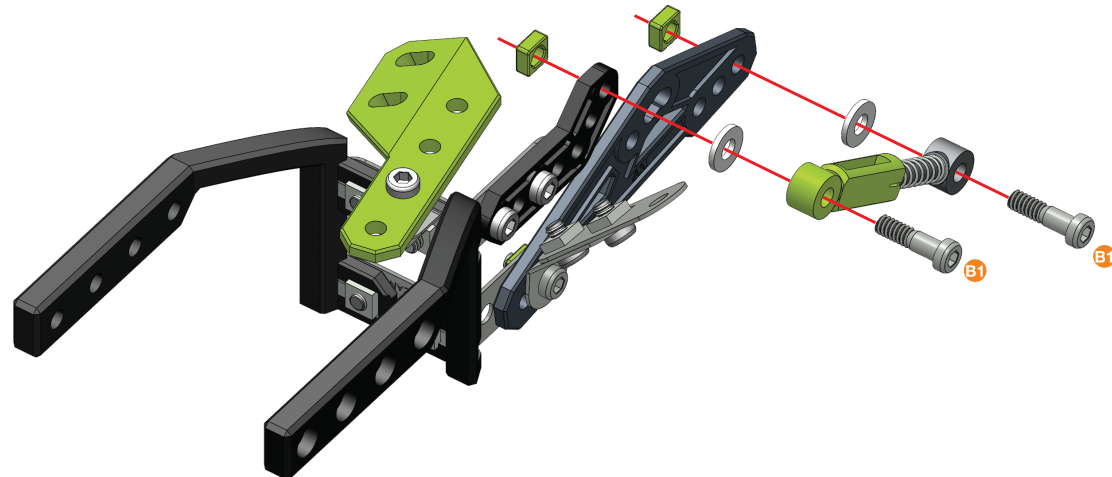
	B1	1:1
	D277	



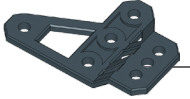

6

	9.5 mm 3/8 in 3/8 po	x2
		x2

	x1
	x1

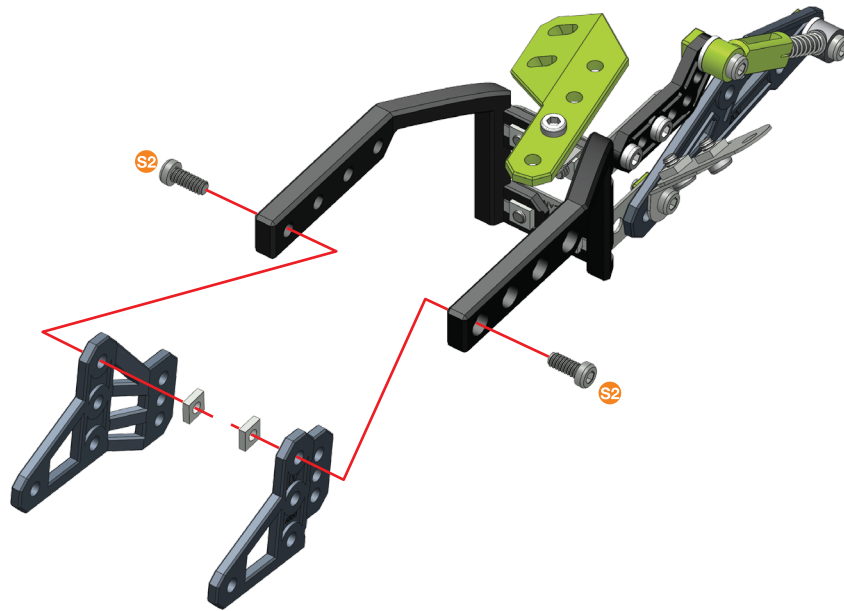
	S2	1:1
--	-----------	------------

**7**

	14.7 mm 37/64 in 37/64 po	x2
		x2



	x2
---	-----------

	x1
--	-----------

	x1
--	-----------

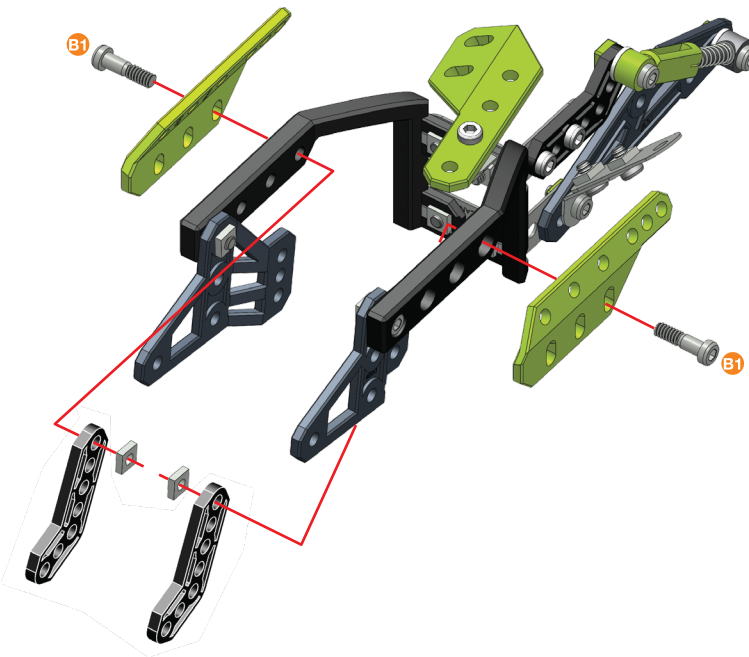
	B1	1:1
--	-----------	------------

**8**

	12 mm 1/2 in 1/2 po	x2
		x2



	x2
	x4

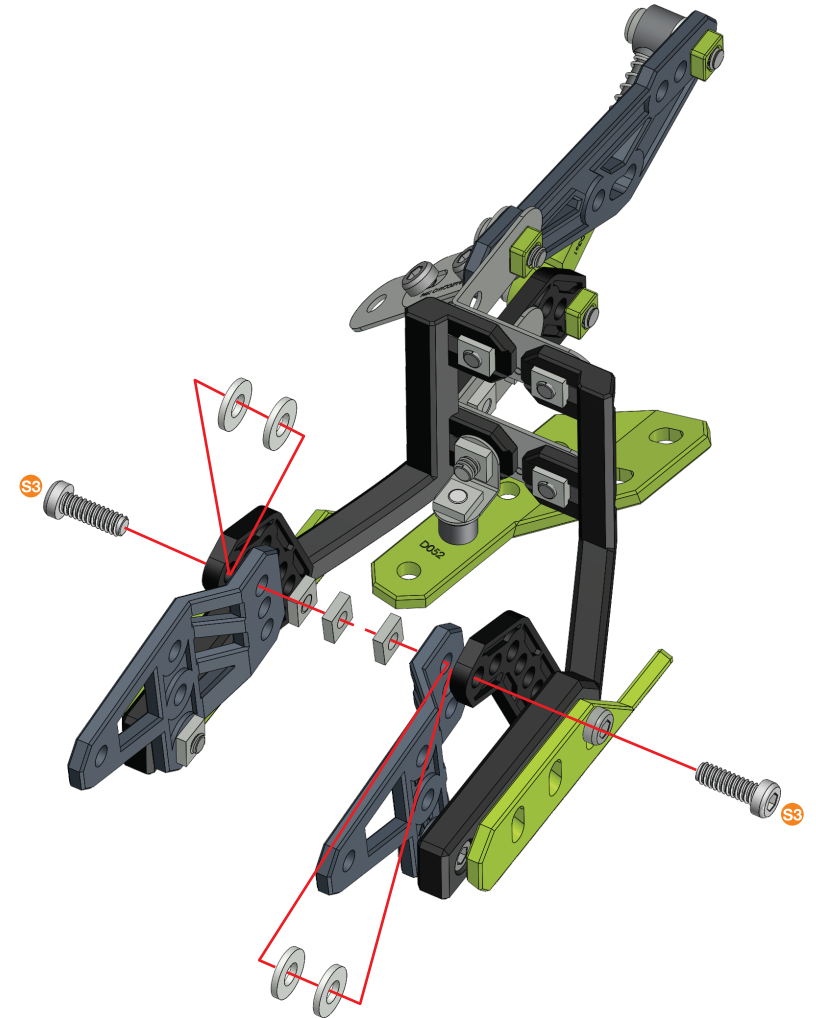

	S3	1:1
---	-----------	------------





9

	12 mm 1/2 in 1/2 po	x4
		x4



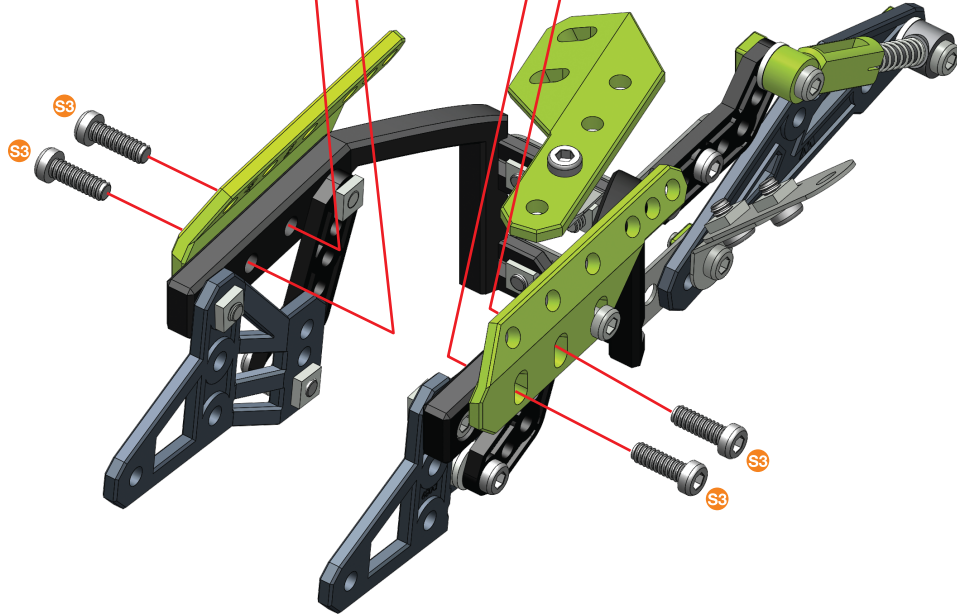

	S3	1:1
--	-----------	------------



**10**

	14.7 mm 37/64 in 37/64 po	x4
		x2

	x2
	x2

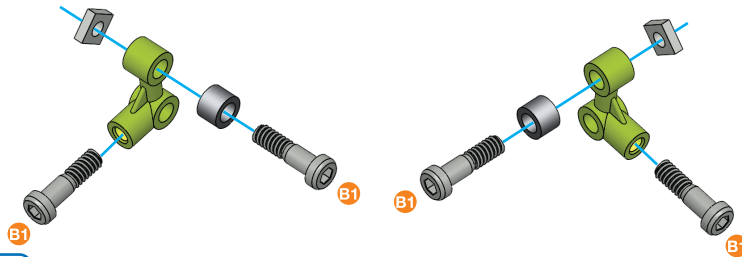
	B1	1:1
	A338	

**11****9+10+**

	14.7 mm 37/64 in 37/64 po	x2
		x2

	B1	1:1
---	-----------	------------

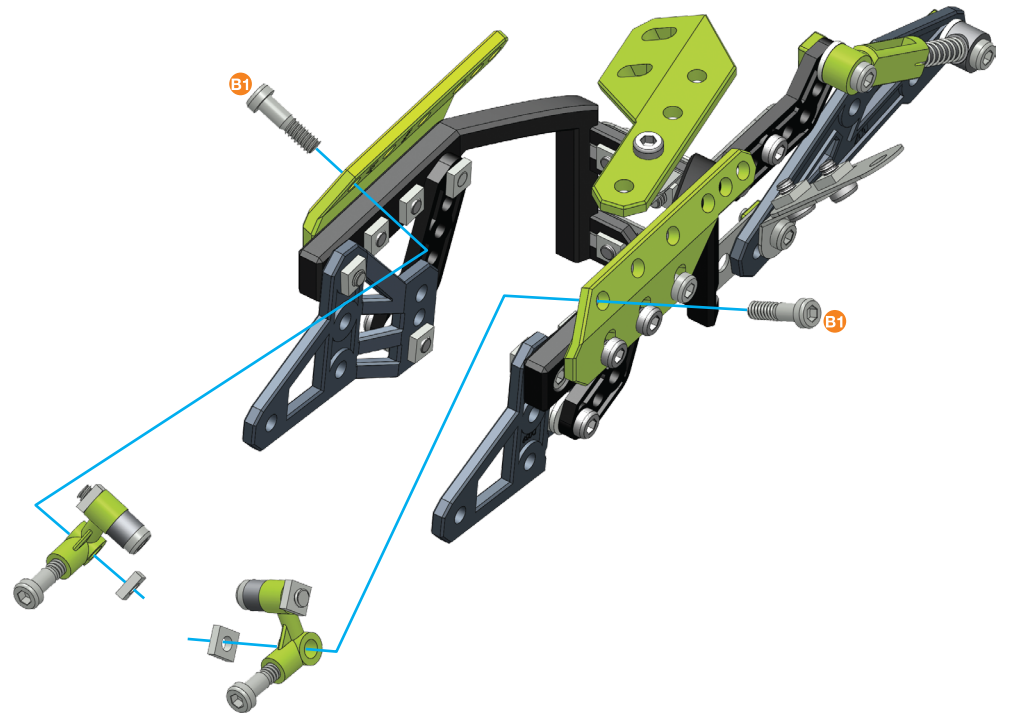

12

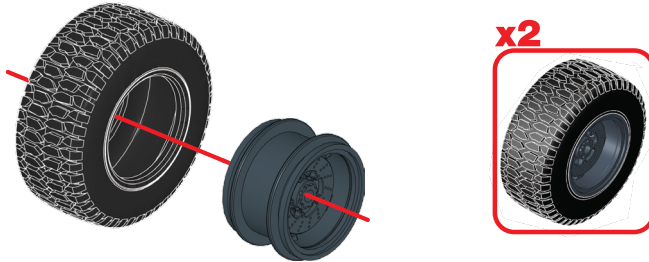

13

(11)+(12)+

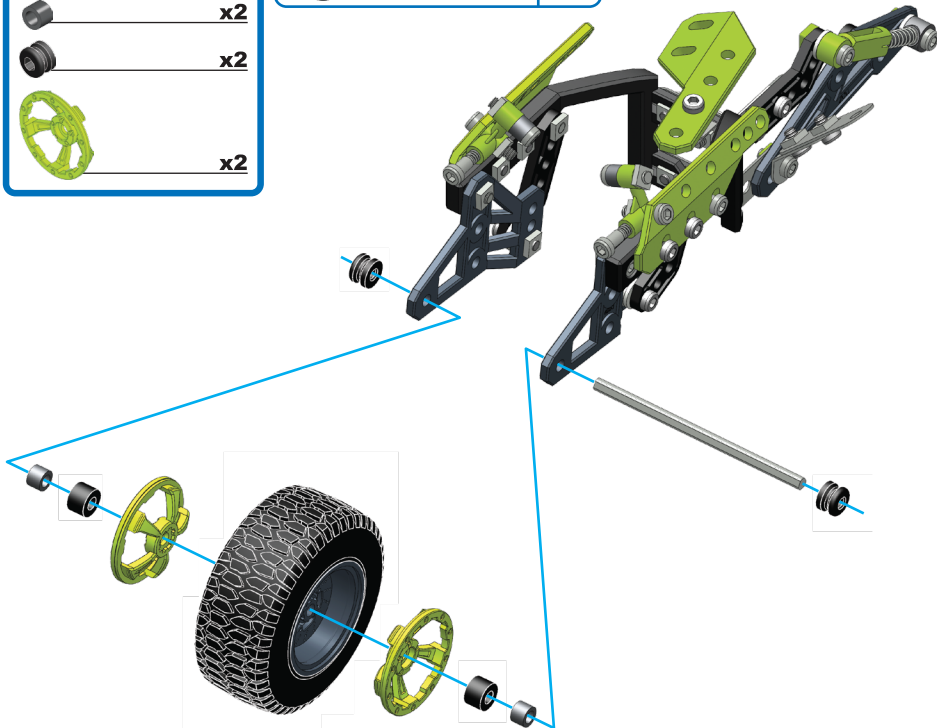
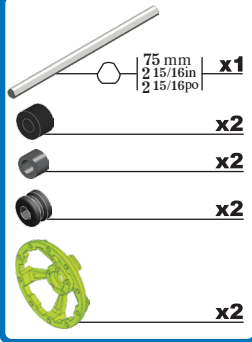

1:1

14

(12)+(13)+

