

















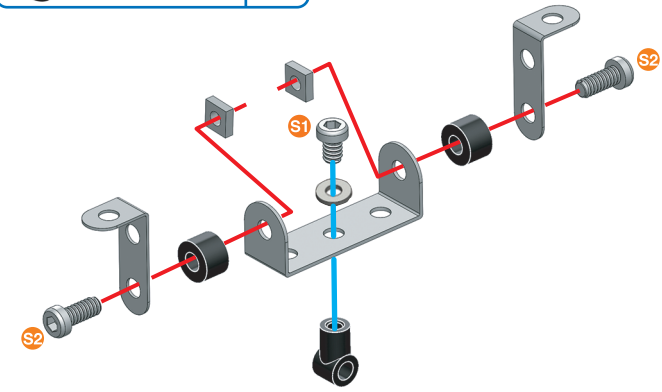
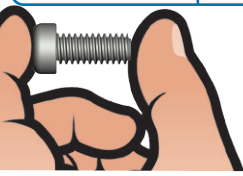
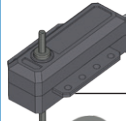

- 1**
-  x1
 -  x2
 -  x2
 -  x1
 -  x1
 -  S1 | 5.8 mm | 15/64 in | 15/64 po | x1
 -  S2 | 9.5 mm | 3/8 in | 3/8 po | x2
 -  x2

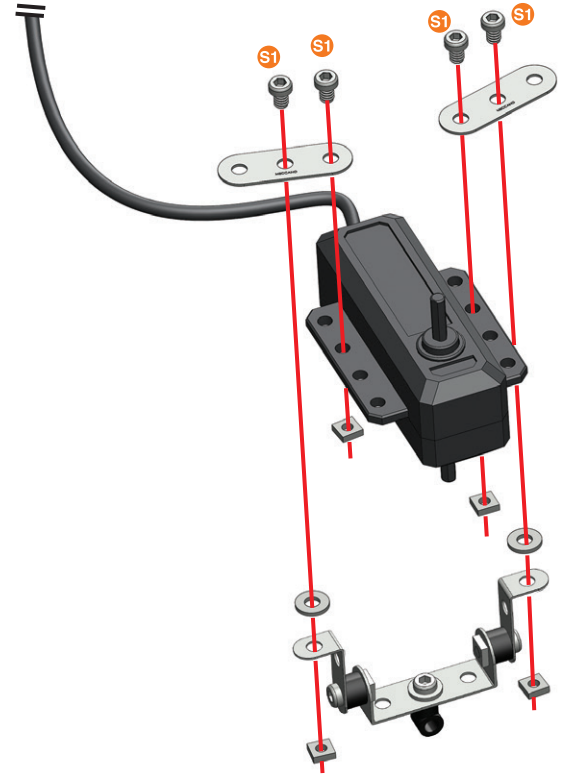

- 2**
-  x1
 -  x2
 -  x2
 -  S1 | 5.8 mm | 15/64 in | 15/64 po | x4
 -  x4



- 3**
-  x2
 -  x4
 -  B2 | 19 mm | 3/4 in | 3/4 po | x2
 -  x2

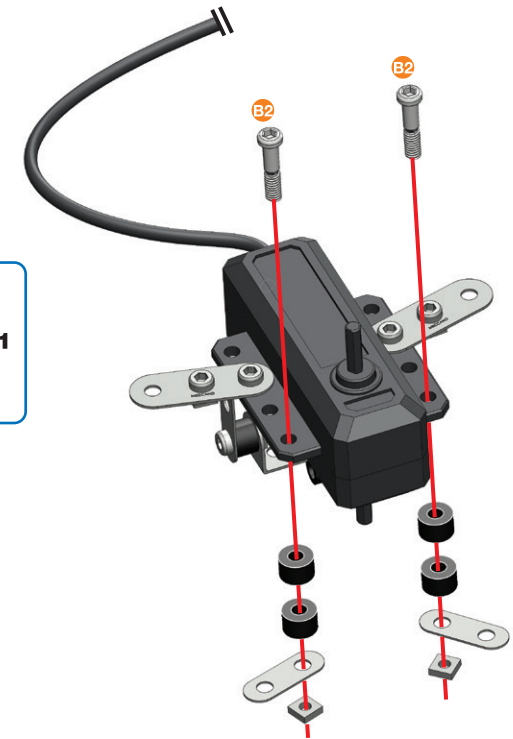
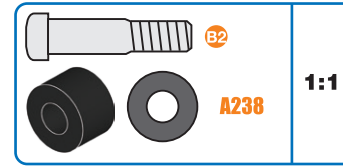

4

- x2
- x2
- 9.5 mm | 3/8 in | 3/8 po x4
- x4

- S2 1:1

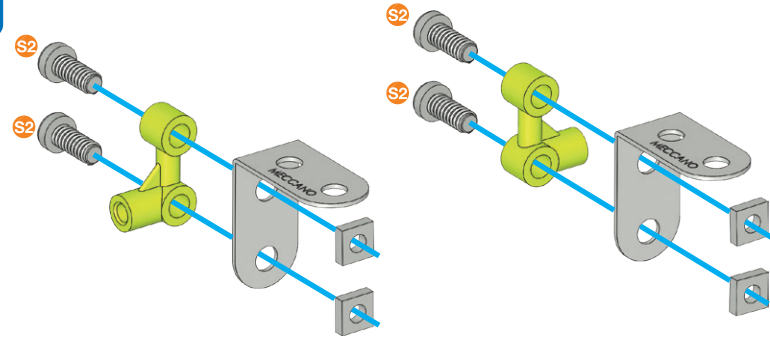

5

- x1
- x2
- 9.5 mm | 3/8 in | 3/8 po x2
- x2

- S2 1:1
- D277

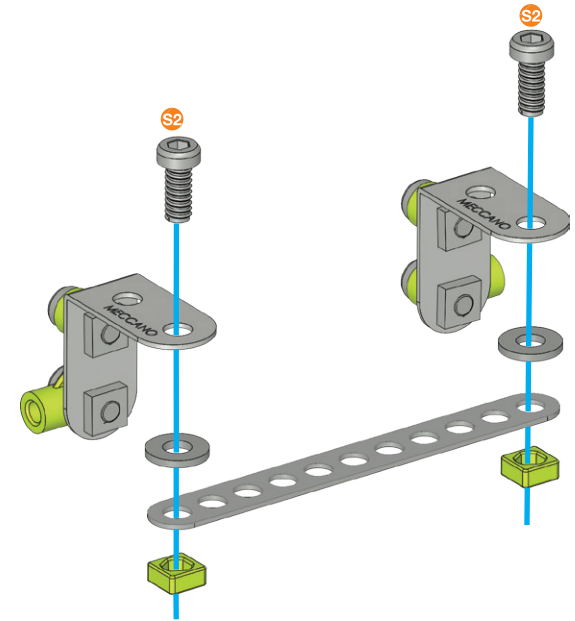

6

③ + ⑤ +

- x2
- 9.5 mm | 3/8 in | 3/8 po x2
- x2

- S2 1:1
- A338
- D277

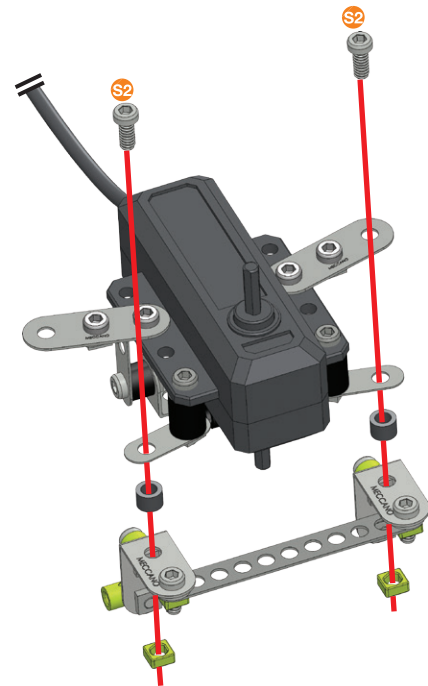





7

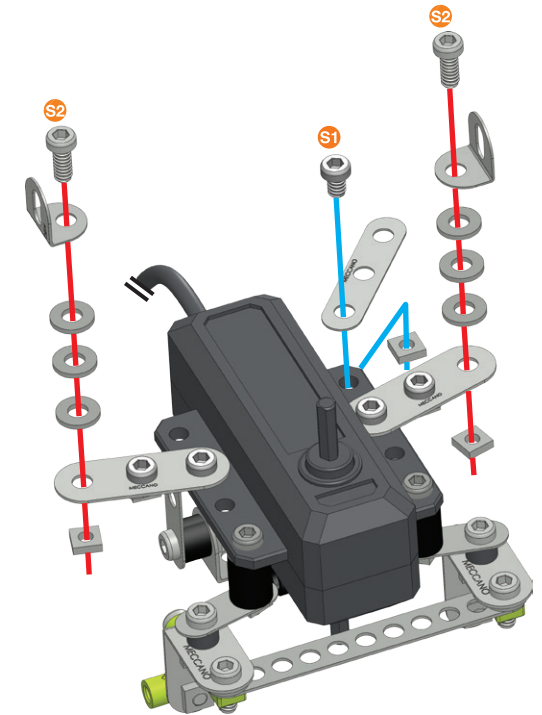

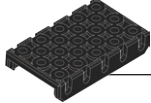

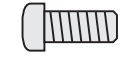

- x6
- x2
- x1
- 5.8 mm | 15/64 in | 15/64 po x1
- 9.5 mm | 3/8 in | 3/8 po x2
- x3

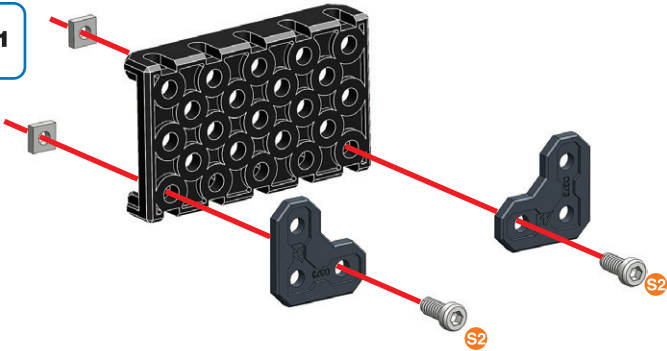
- S1 1:1
- S2 1:1







- 8**
-  x1
 -  x2
 -  x2
 -  x2
 -  x2
 -  x1

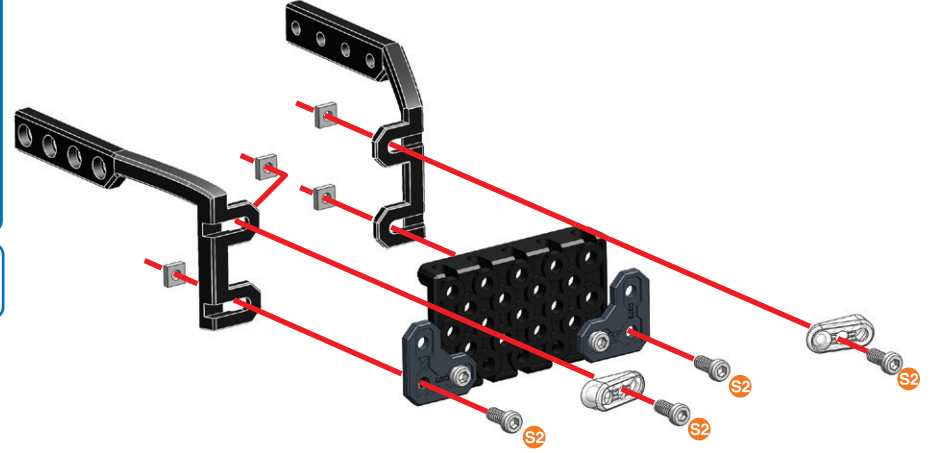



- 9**
-  x1
 -  x1
 -  x2
 -  x4
 -  x4
 -  x1

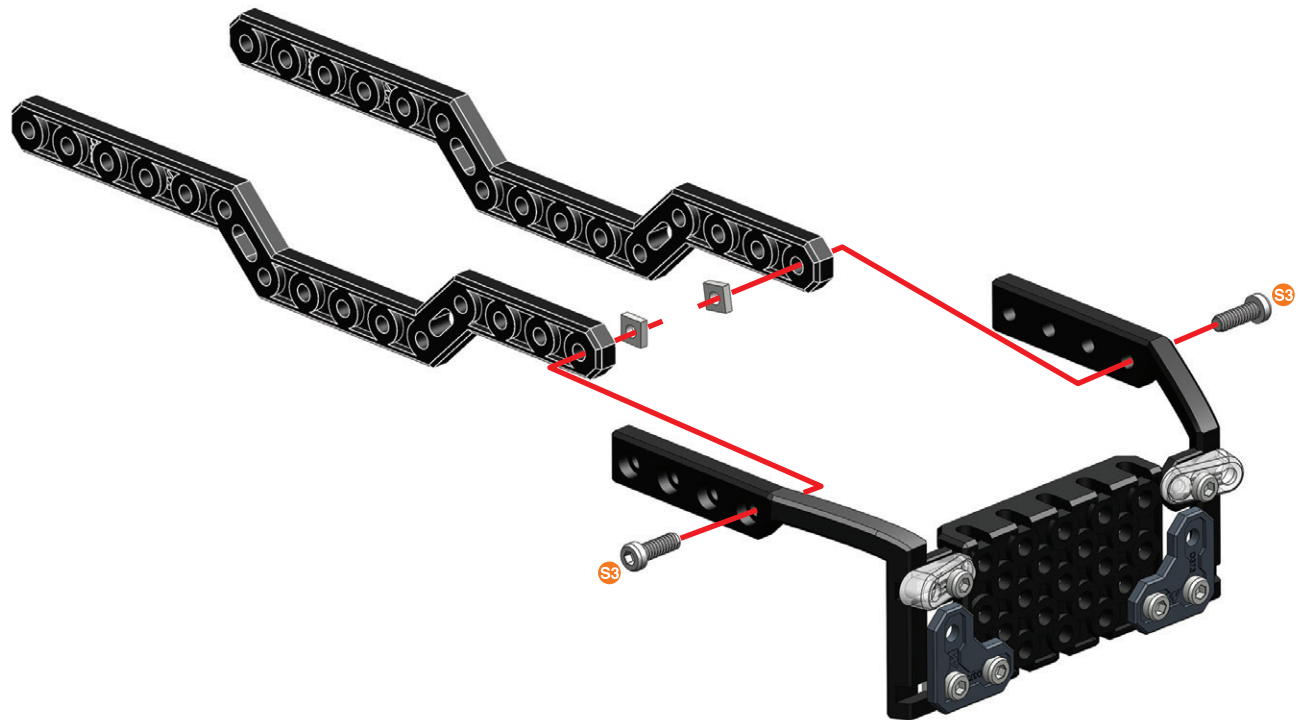

- 10**
-  x2
 -  x2
 -  x2
 -  x2
 -  x1





11**⑦ + ⑩ +**

	14.7 mm 37/64 in 37/64 po	x2
		x2
		x2

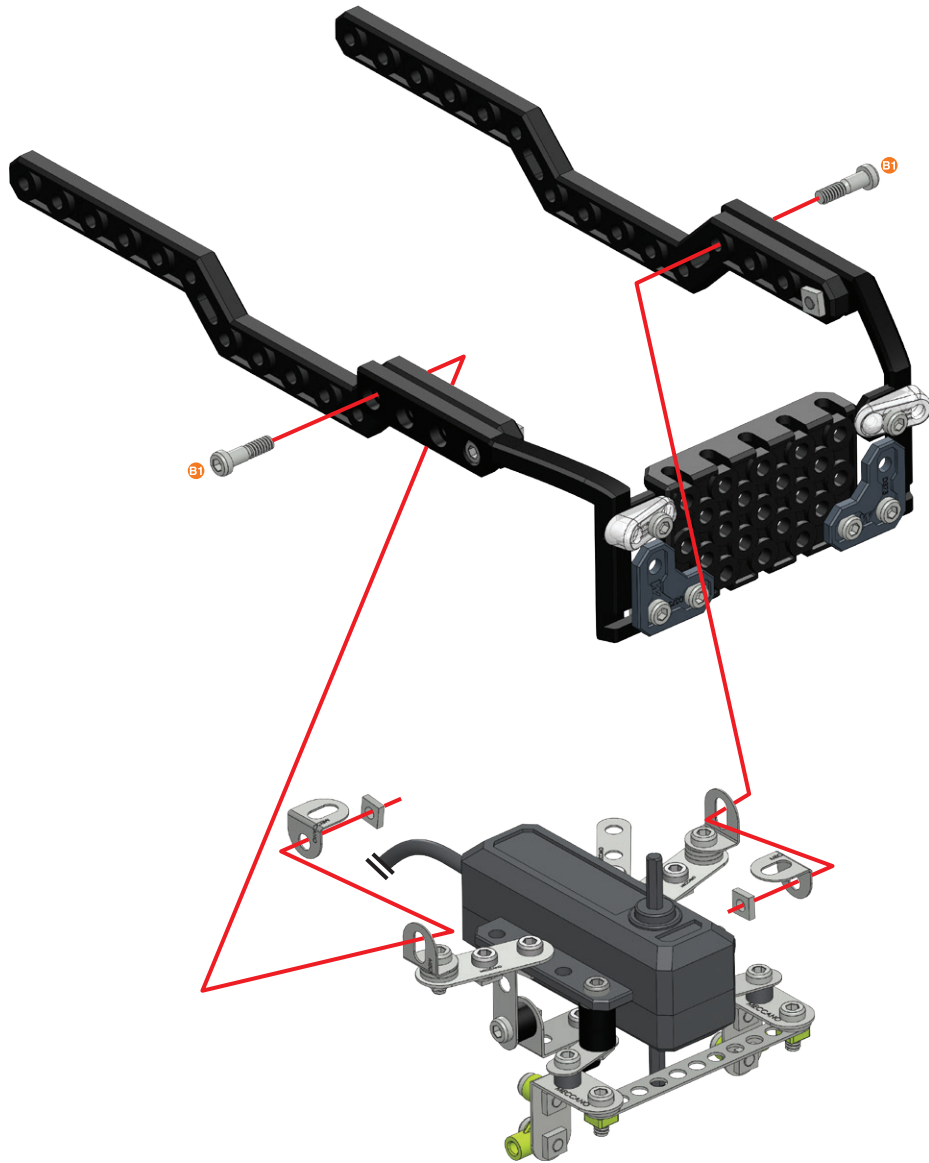

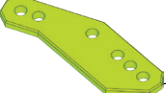

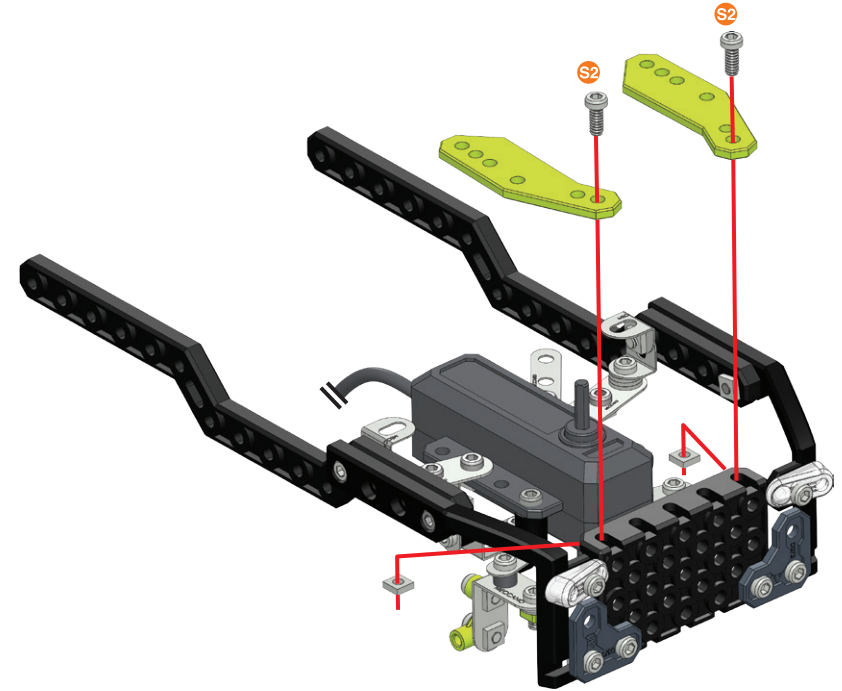

		1:1
---	--	------------

**12**

		x2
	9.5 mm 3/8 in 3/8 po	x2
		x2

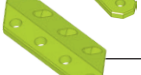
		1:1
---	--	------------

**13**

		x1
		x1
		x1
		x1
		x4
	14.7 mm 37/64 in 37/64 po	x2
		x2

		1:1
---	--	------------

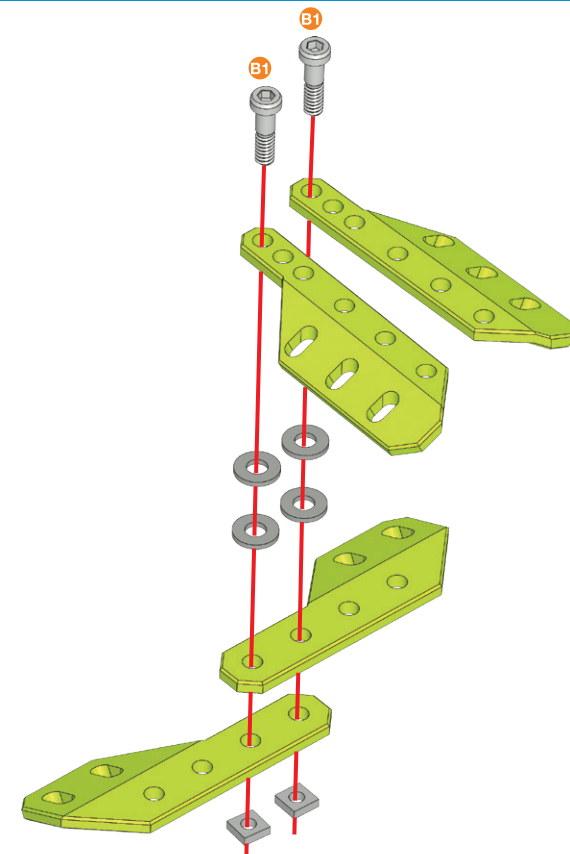

14

(12) + (13) +

	x2
	x2
	x2

	1:1
--	-----

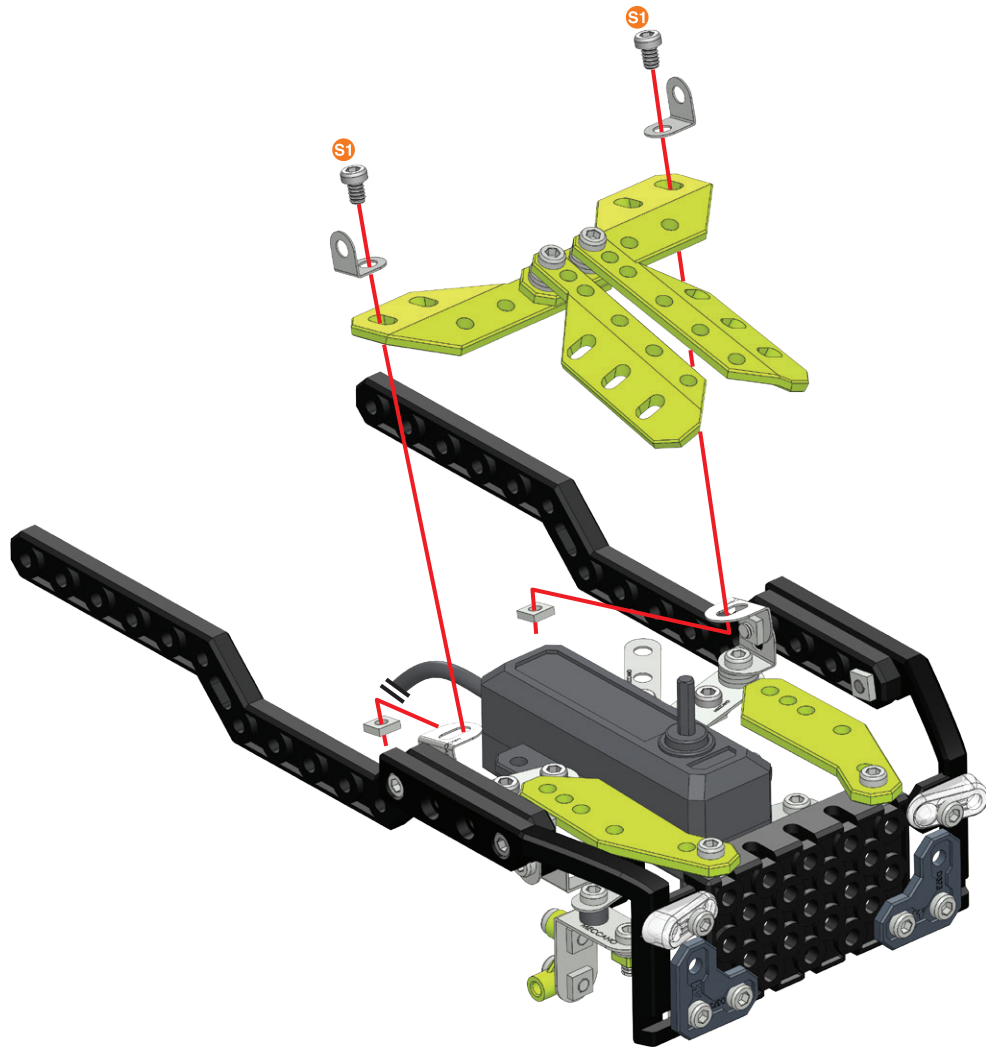

15

	x2
	x1
	x1
	x1
	x2
	x1
	x2

	1:1
	1:1

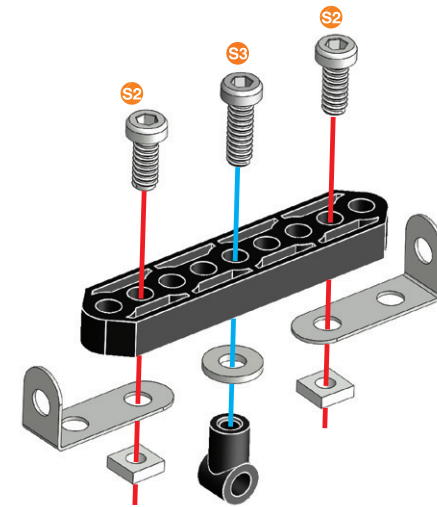



16

	x1
	x1
	x2
	x2
	x2
	x4

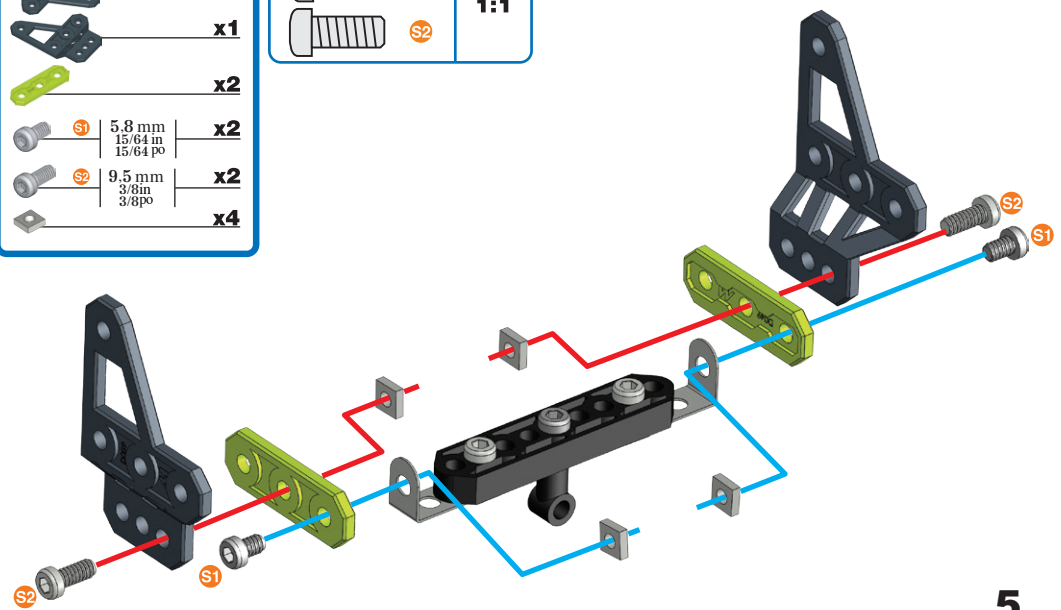
	1:1
	1:1





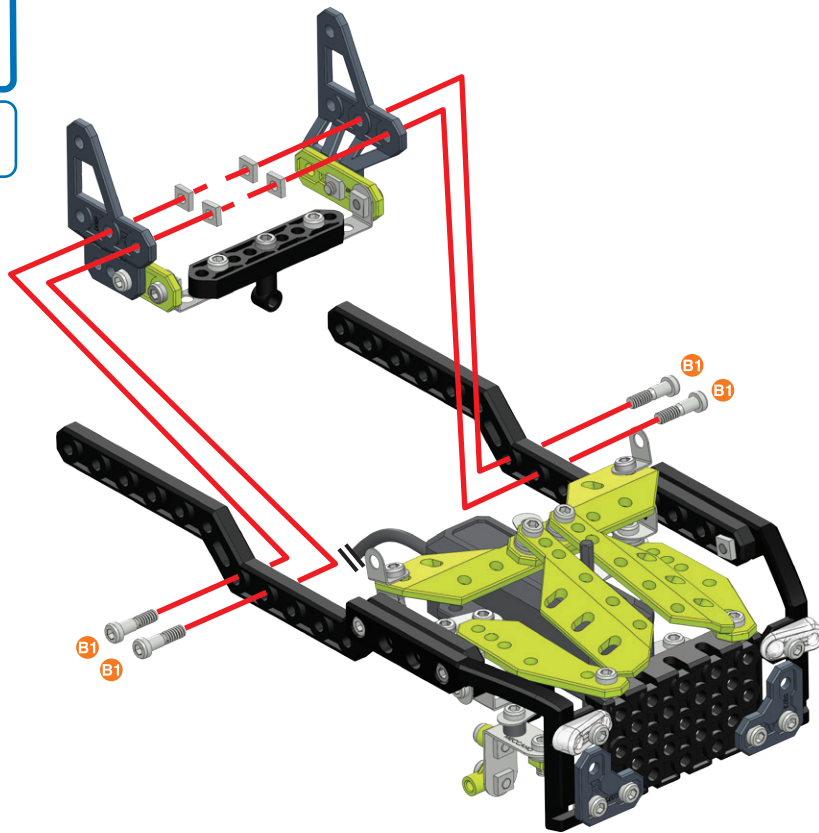

17 (14) + (16) +

	14.7 mm 37/64 in 37/64 po	x4
		x4

	B1	1:1
---	-----------	------------



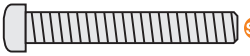

18

		x1
		x1
	28 mm 1 1/8 in 1 1/8 po	x1
		x1

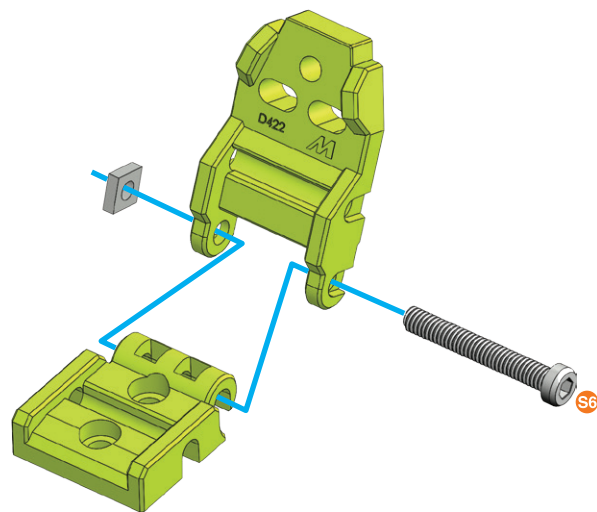
	S6	1:1
---	-----------	------------





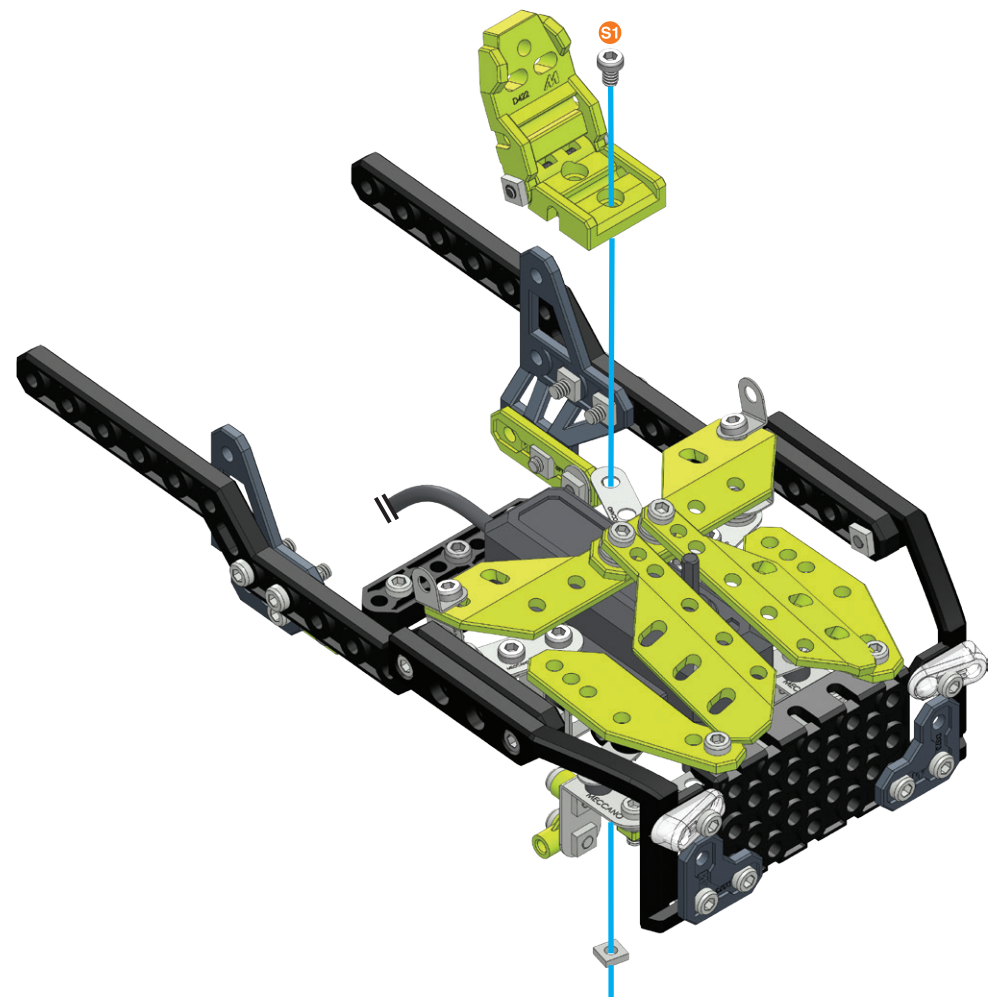

19 (17) + (18) +

	5.8 mm 15/64 in 15/64 po	x1
		x1

	S1	1:1
---	-----------	------------





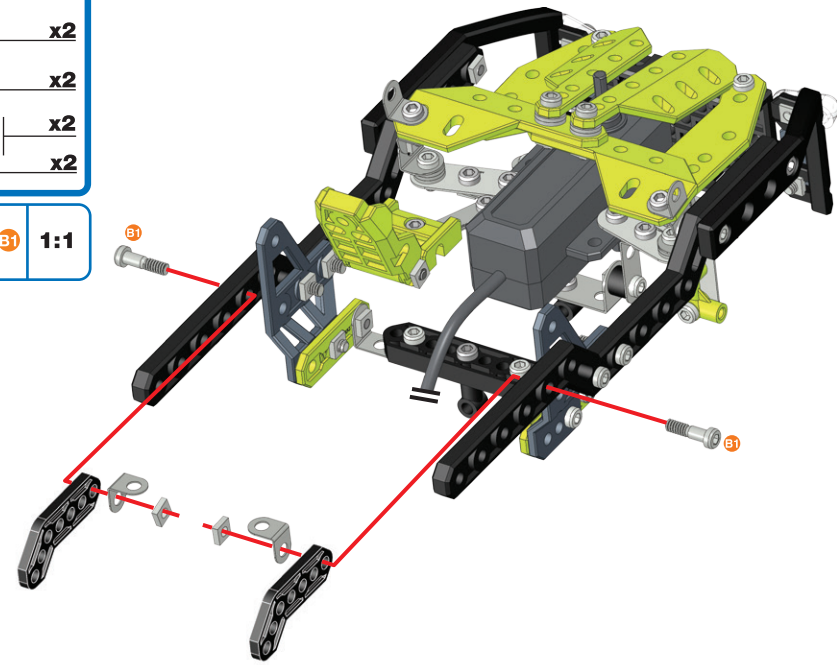

20

-  x2
-  x2
-  14.7 mm | 37/64 in | 37/64 po x2
-  x2
-  1:1



21

-  100 mm | 3 15/16 in | 3 15/16 po x1
-  x1
-  x2
-  x1
-  x2

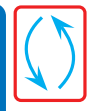

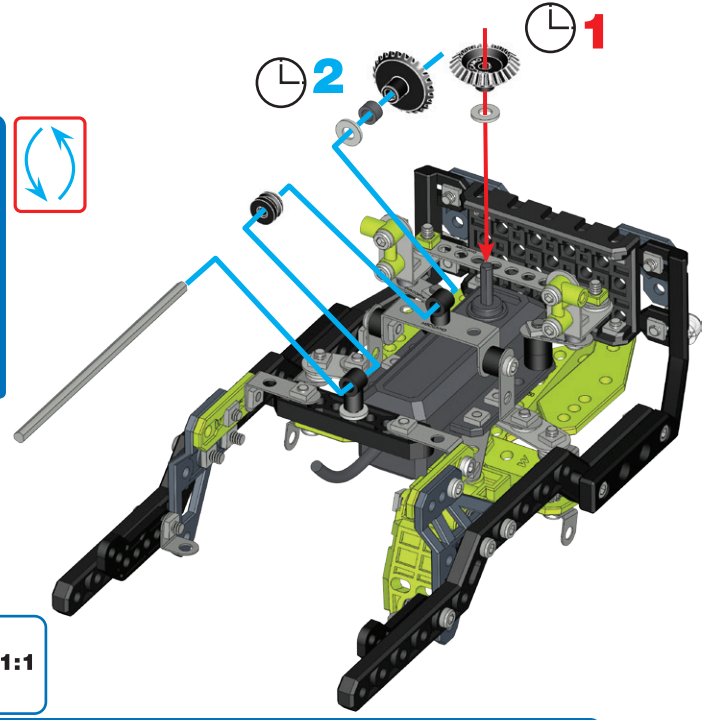

-   A338 1:1

-  1:1



22

-  x2
-  x2
-  x2

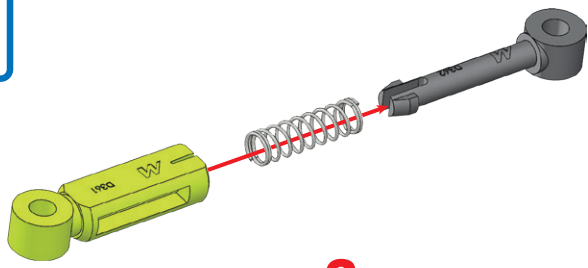



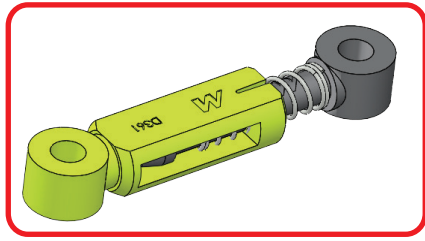

x2



23

(21) + (22) +



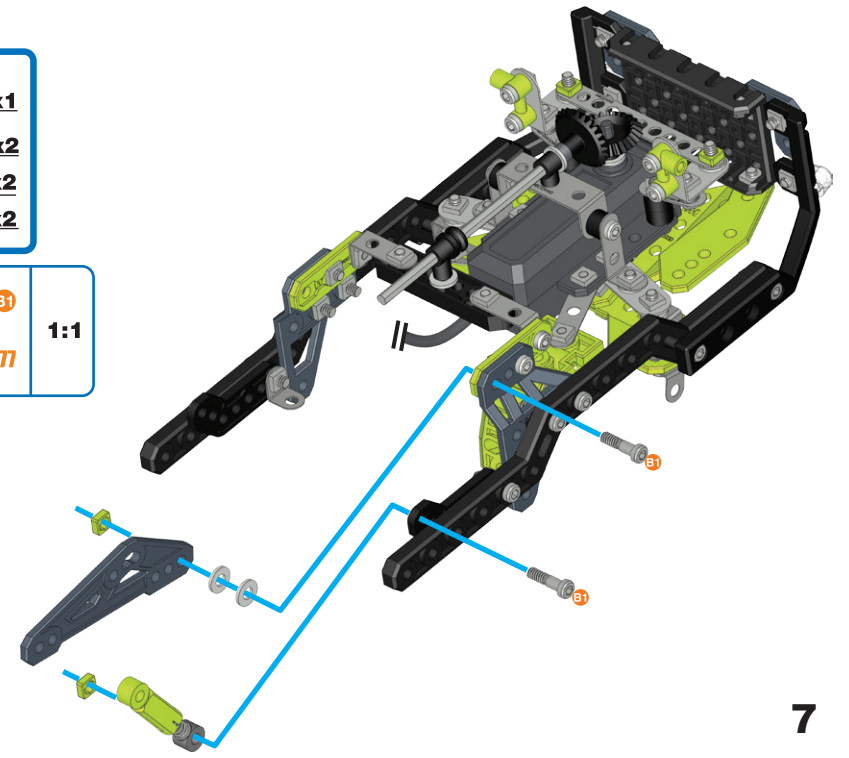

-  x1
-  x2
-  14.7 mm | 37/64 in | 37/64 po x2
-  x2

-  1:1
-  D277



24

22 + 23 +





-  x1
-  x2
-  14.7 mm | 37/64 in | 37/64 po x2
-  x2

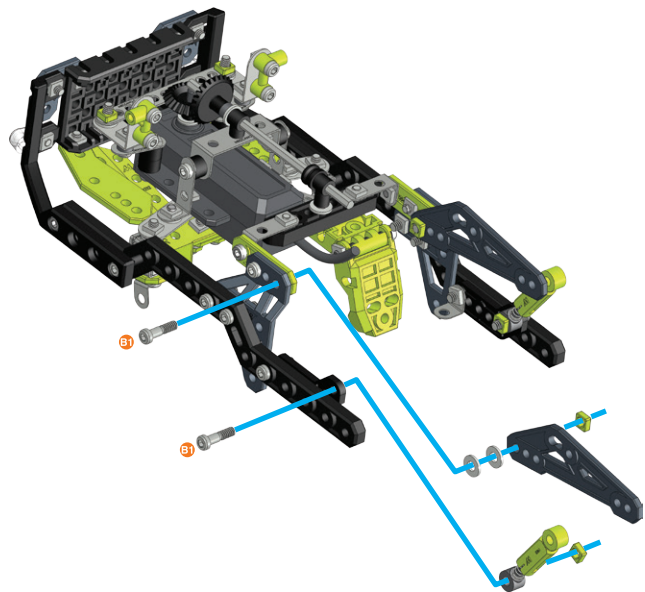

-  B1 1:1
-  D277







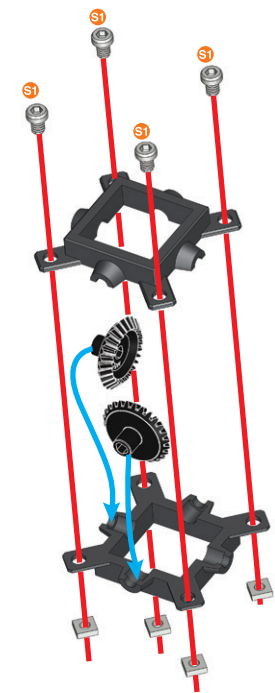

25

-  x2
-  x2
-  S1 5.8 mm | 15/64 in | 15/64 po x4
-  x4

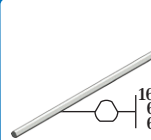
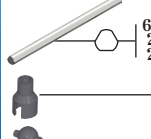
-  S1 1:1



26

-  165 mm | 6 1/2 in | 6 1/2 po x1
-  60 mm | 2 3/8 in | 2 3/8 po x1
-  x1
-  x1
-  x1
-  x1
-  x4



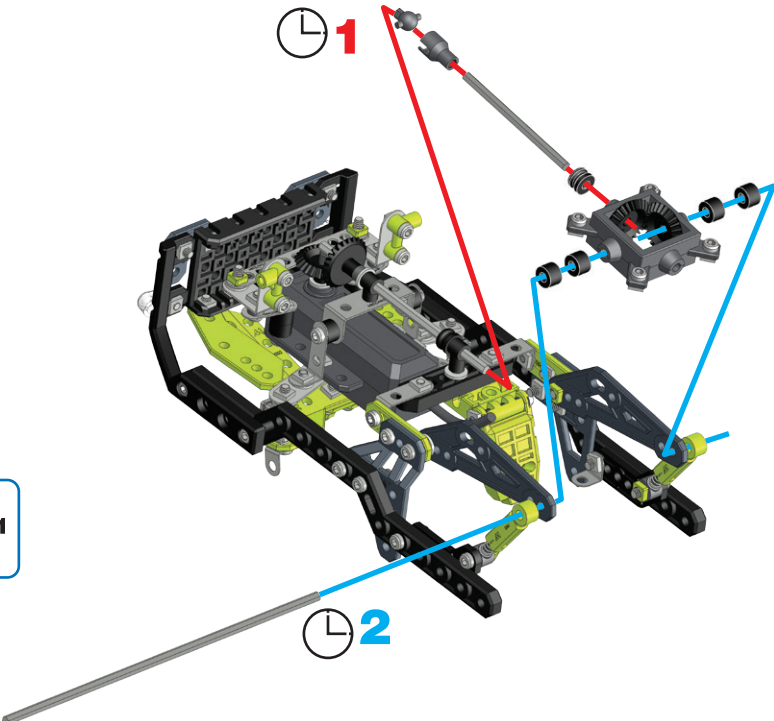



-  A238 1:1





1

2

27

-  x1
-  x1
-  x2
-  B1 14.7 mm | 37/64 in | 37/64 po x2
-  S4 19 mm | 3/4 in | 3/4 po x2
-  x4





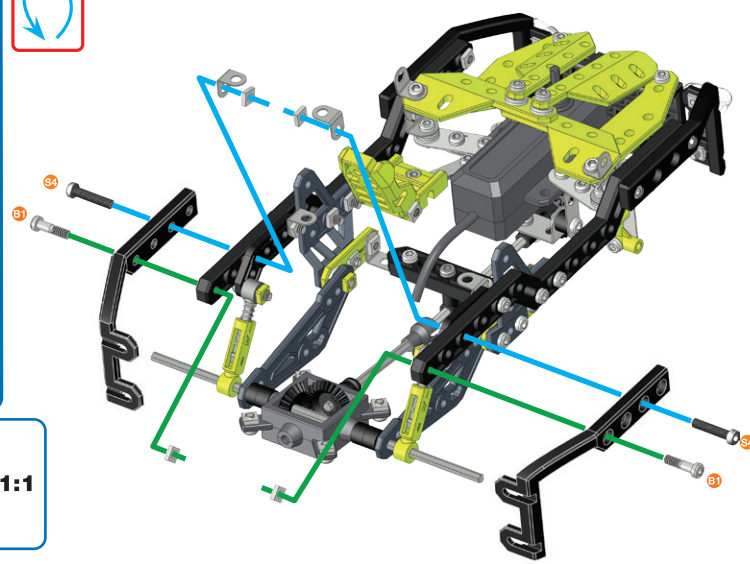

-  B1 1:1
-  S4 1:1





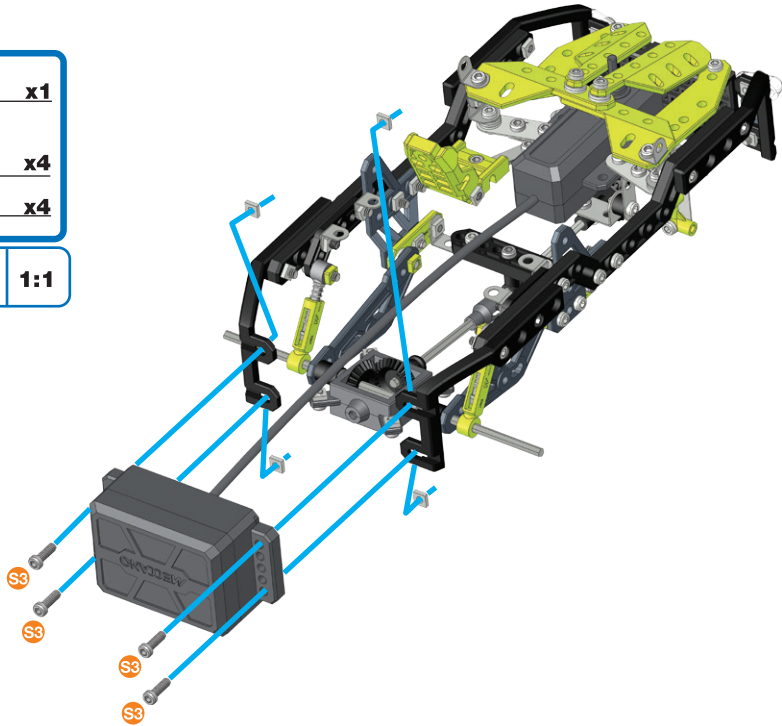

1:1

28

-  **x1**
-  **12 mm** | **x4**
1/2 in | 1/2 po
-  **x4**
-  **S3** | **1:1**



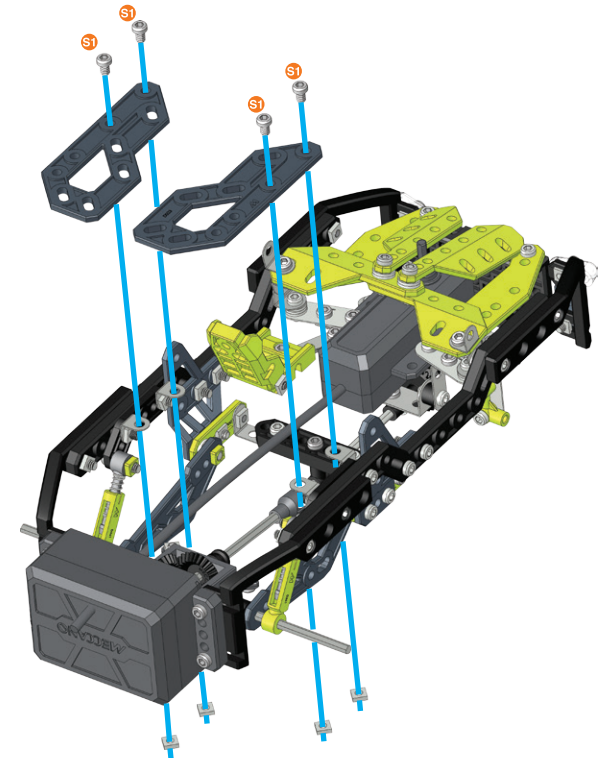

29

-  **x2**
-  **5.8 mm** | **x4**
15/64 in | 15/64 po
-  **x4**
-  **S1** | **1:1**





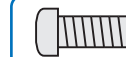

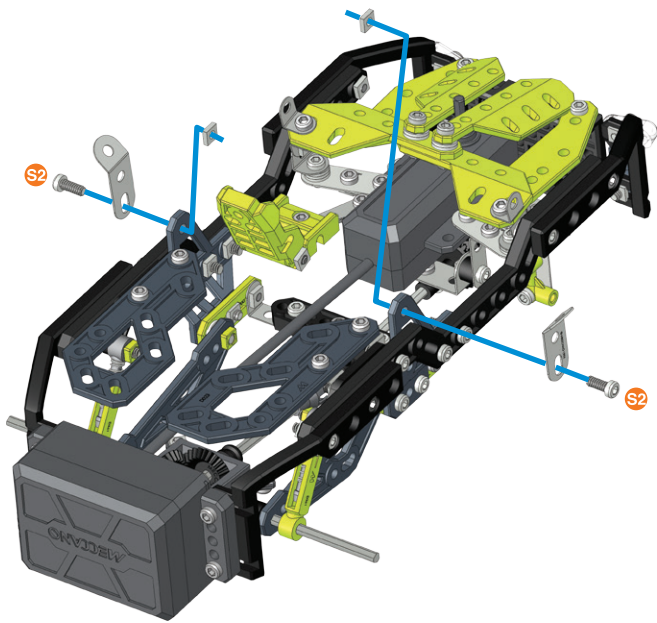
30

-  **x2**
-  **9.5 mm** | **x2**
3/8 in | 3/8 po
-  **x2**
-  **S2** | **1:1**



31

-  **x2**
-  **9.5 mm** | **x2**
3/8 in | 3/8 po
-  **x2**
-  **S2** | **1:1**

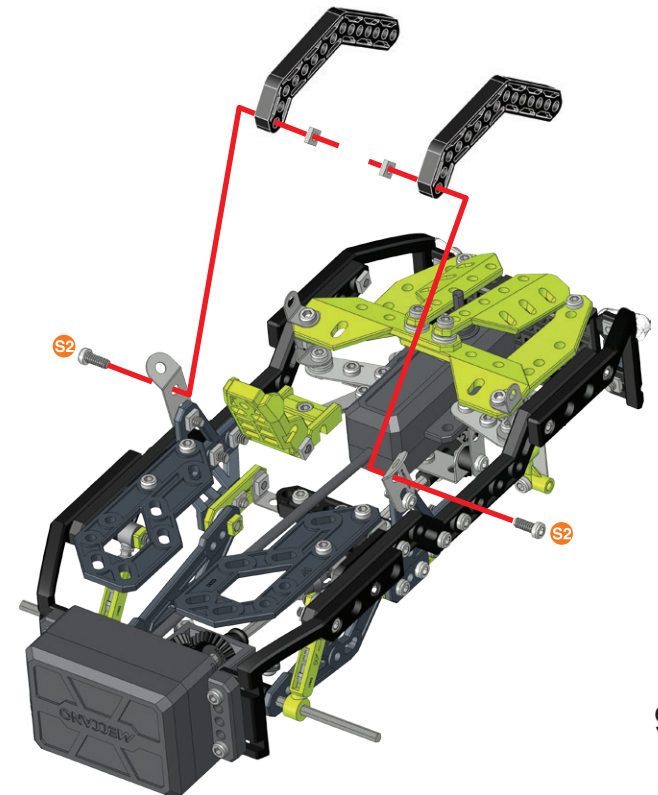

32

	x2
	x1
	x2
	x4
	x6

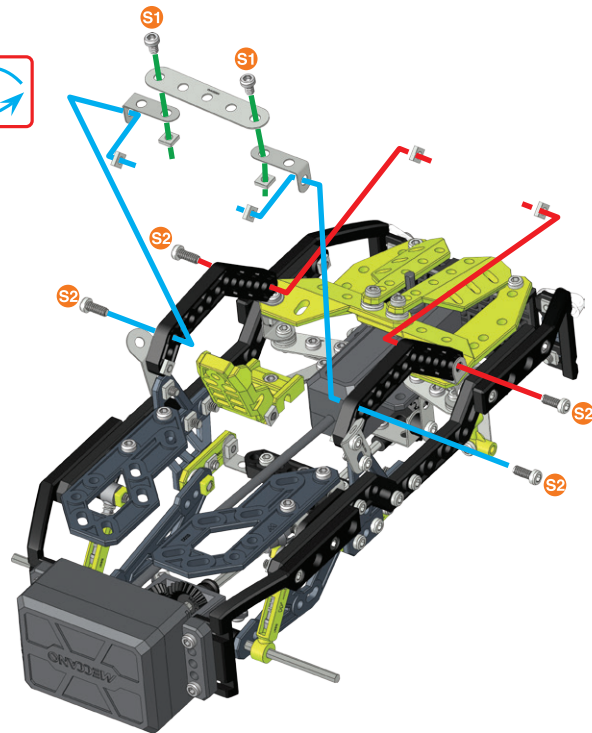

	1:1

33

	x4
	x4

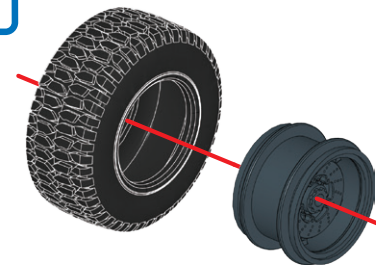

x4



34



Ⓧ32 + Ⓧ33 +



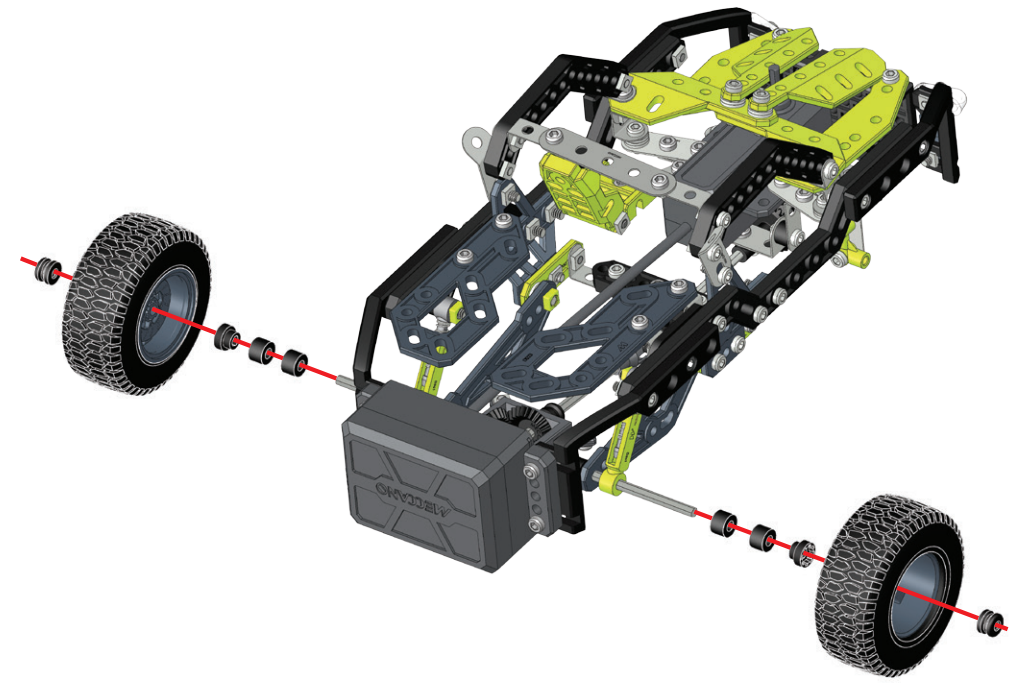

	x2
	x2
	x4

	A238	1:1
--	-------------	------------



35 33+34+

	25.4 mm 1 in 1 00	x2
		x2
		x2

	S5		
		A238	1:1
			
		D277	

