

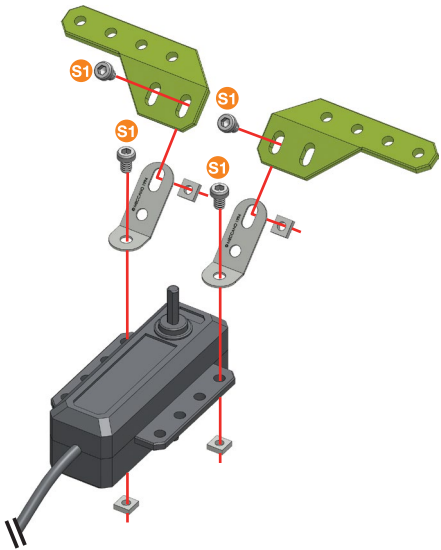

- 1**
- 5.8 mm | 15/64 in | 15/64 po **x4**
 - x4**
 - x2**
 - x1**
 - x1**
 - x1**

- 1:1**



- 2**
- 9.5 mm | 3/8 in | 3/8 po **x4**
 - x4**
 - x1**
 - x1**

- 1:1**

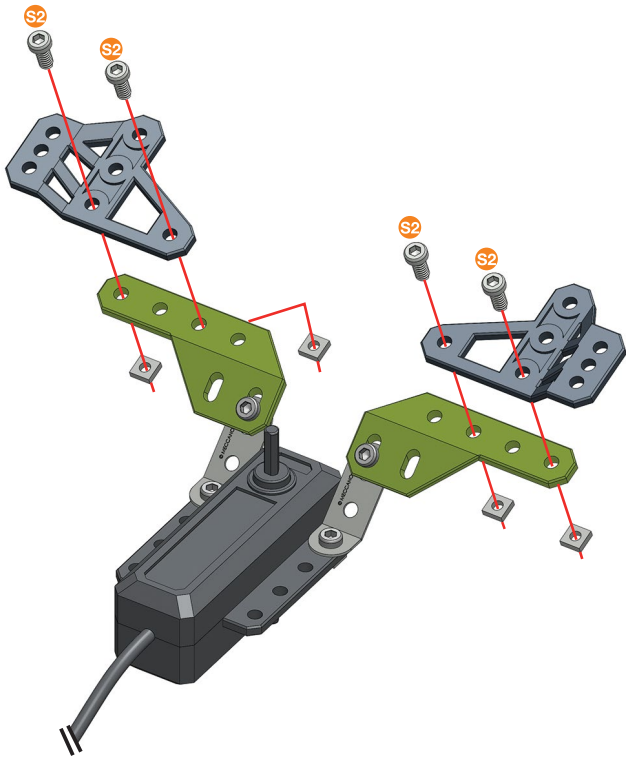

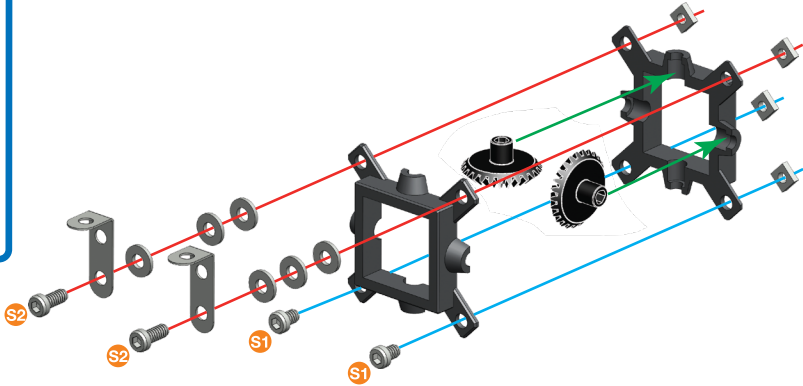

- 3**
- 5.8 mm | 15/64 in | 15/64 po **x2**
 - 9.5 mm | 3/8 in | 3/8 po **x2**
 - x4**
 - x6**
 - x2**
 - x2**
 - x2**

- 1:1**
- 1:1**









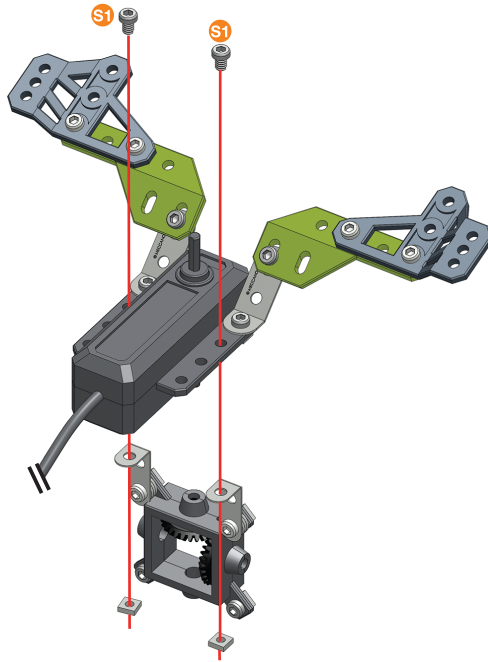

4**(2)+(3)+**

	5.8 mm 15/64 in 15/64 po	x2
		x2







	1:1
--	------------

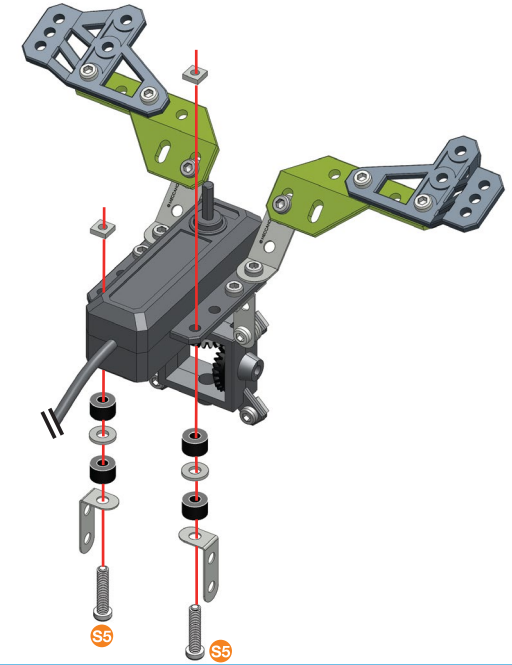

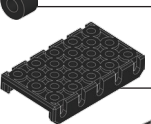

**5**

	25.4 mm 1 in 1 po	x2
		x2
		x2
		x4
		x2







	1:1
	A238
	

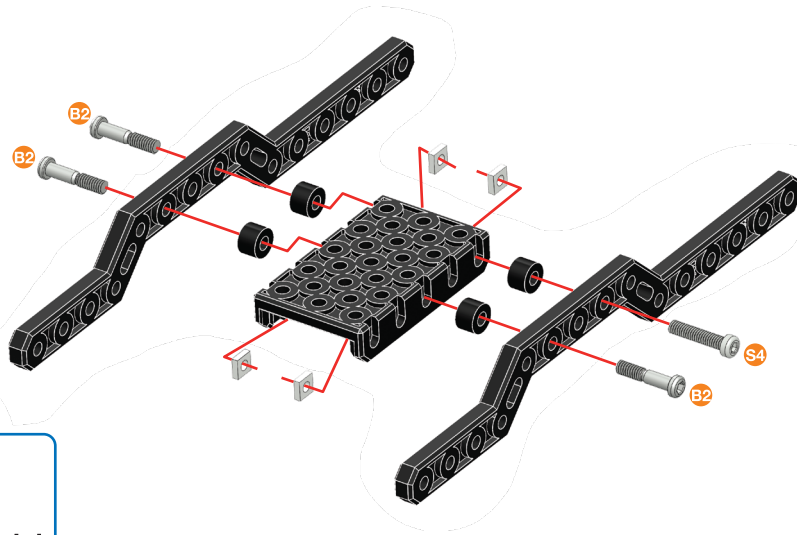



**6**

	19 mm 3/4 in 3/4 po	x3
	19 mm 3/4 in 3/4 po	x1
		x4
		x4
		x1
		x2

	S4
	B2
	A238
	
1:1	





**7**

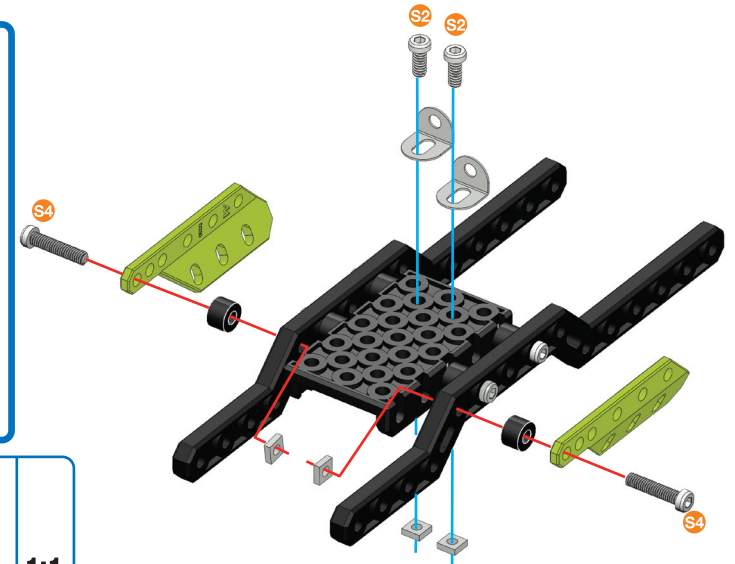

	9.5 mm 3/8 in 3/8 po	x2
	19 mm 3/4 in 3/4 po	x2
		x4
		x2
		x2
		x1
		x1

	S2
	S4
	A238
	
1:1	





8

-  S1 5.8 mm | x1
15/64 in
15/64 po
-  B1 14.7 mm | x4
37/64 in
37/64 po
-  x5
-  x1
-  x2

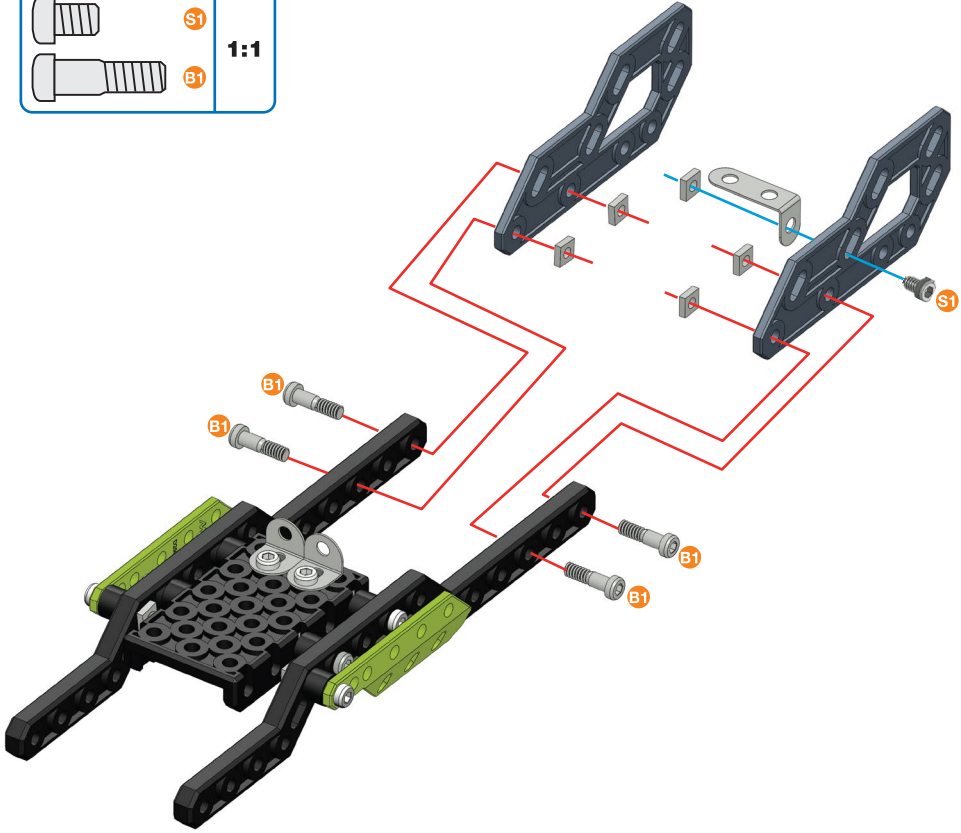
-  S1
-  B1
- 1:1



9

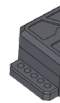

-  S2 9.5 mm | x2
3/8 in
3/8 po
-  x2
-  x1



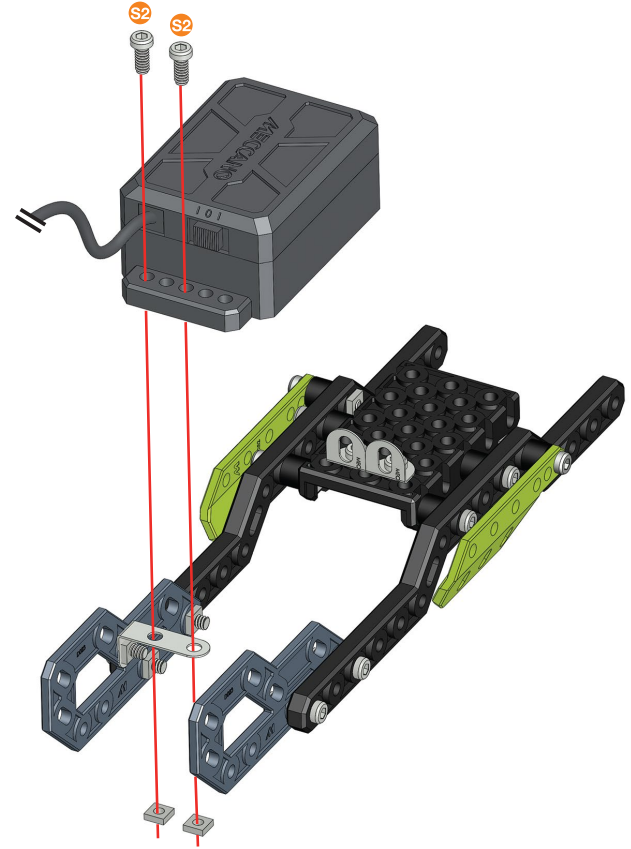

-  S2
- 1:1



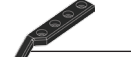
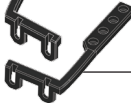



10

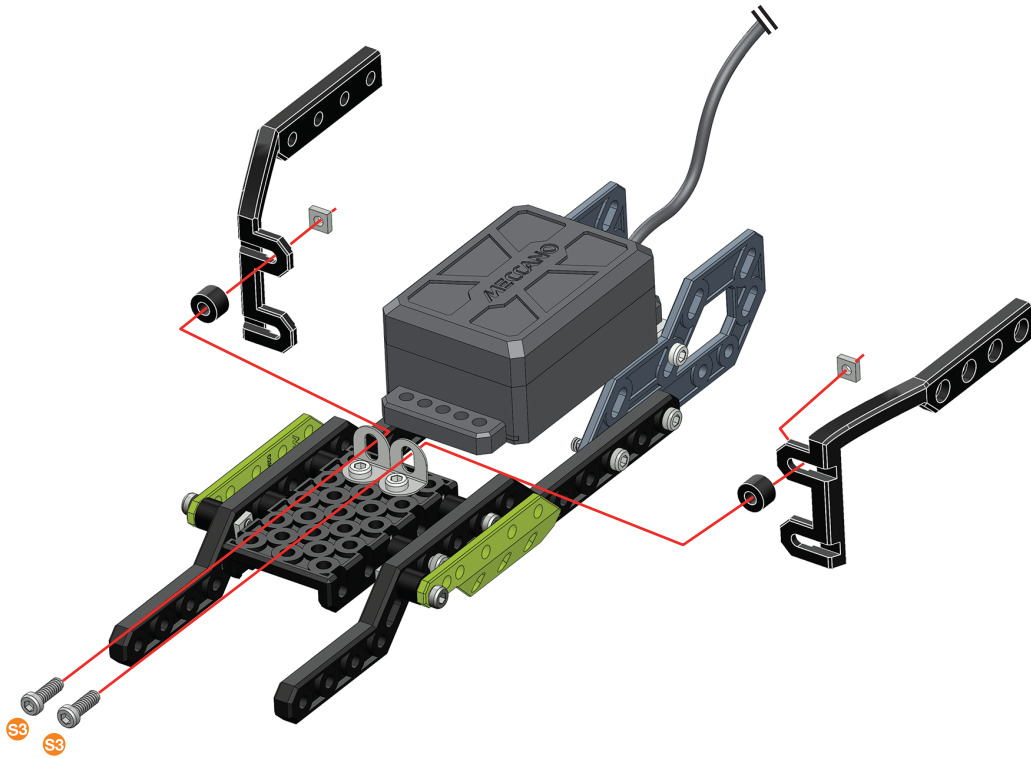

-  12 mm | 1/2 in | 1/2 po | **x2**
-  **x2**
-  **x2**
-  **x1**
-  **x1**

-  **S3**
-  **A238** | **1:1**



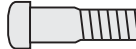

11

-  5.8 mm | 15/64 in | 15/64 po | **x1**
-  14.7 mm | 37/64 in | 37/64 po | **x1**
-  **x2**
-  **x1**
-  **x1**

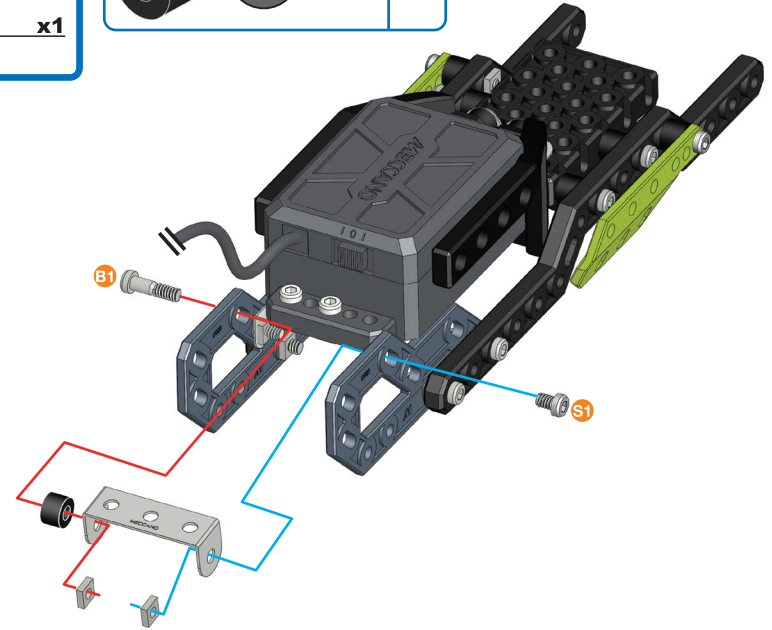
-  **S1**
-  **B1** | **1:1**
-  **A238**

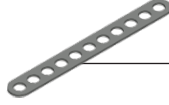

12

-  5.8 mm | 15/64 in | 15/64 po | **x2**
-  **x2**
-  **x2**
-  **x1**

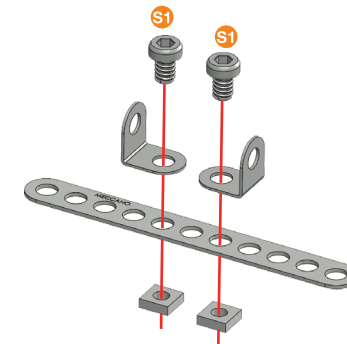

-  **S1** | **1:1**

13

- 9.5 mm | 3/8 in | 3/8 po | **x2**
- x2**
- x2**

- 1:1**

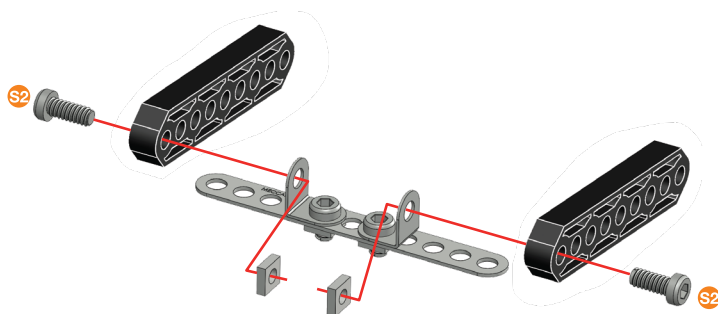

14

- 12 mm | 1/2 in | 1/2 po | **x2**
- x2**
- x2**

- D277**
- 1:1**

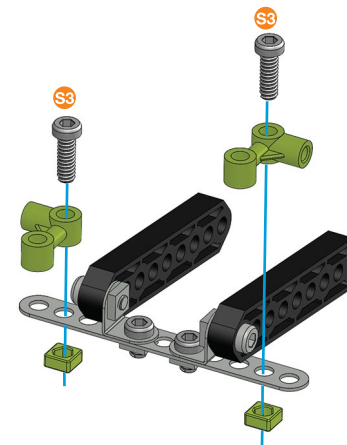

15

- 12 mm | 1/2 in | 1/2 po | **x2**
- x2**
- x1**

- D277**
- 1:1**

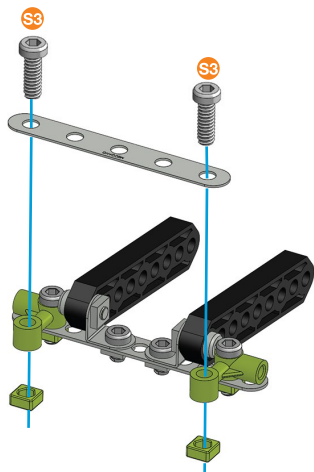

16

- 5.8 mm | 15/64 in | 15/64 po | **x3**
- x3**
- x1**

- 1:1**

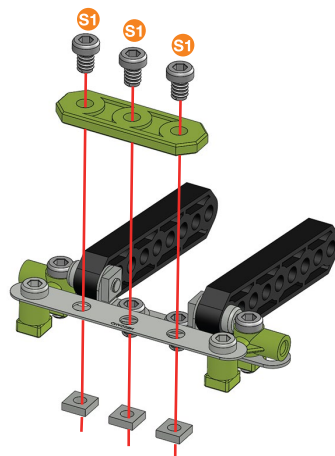



17

- 14.7 mm | 37/64 in | 37/64 po | **x4**
- x4**
- x2**

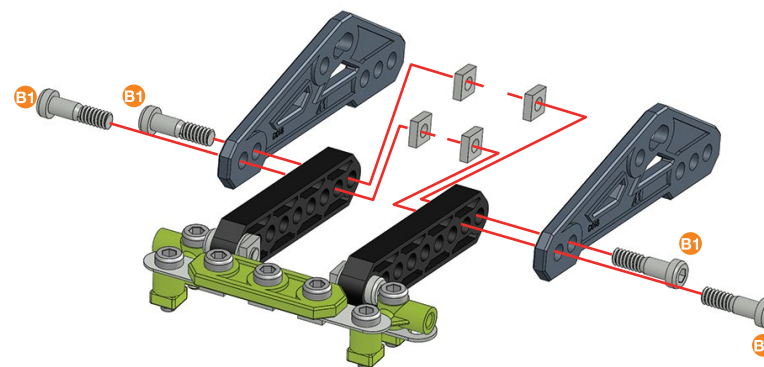
- 1:1**





18**11+17+**

	B1	14,7 mm 37/64 in	x4
			x4

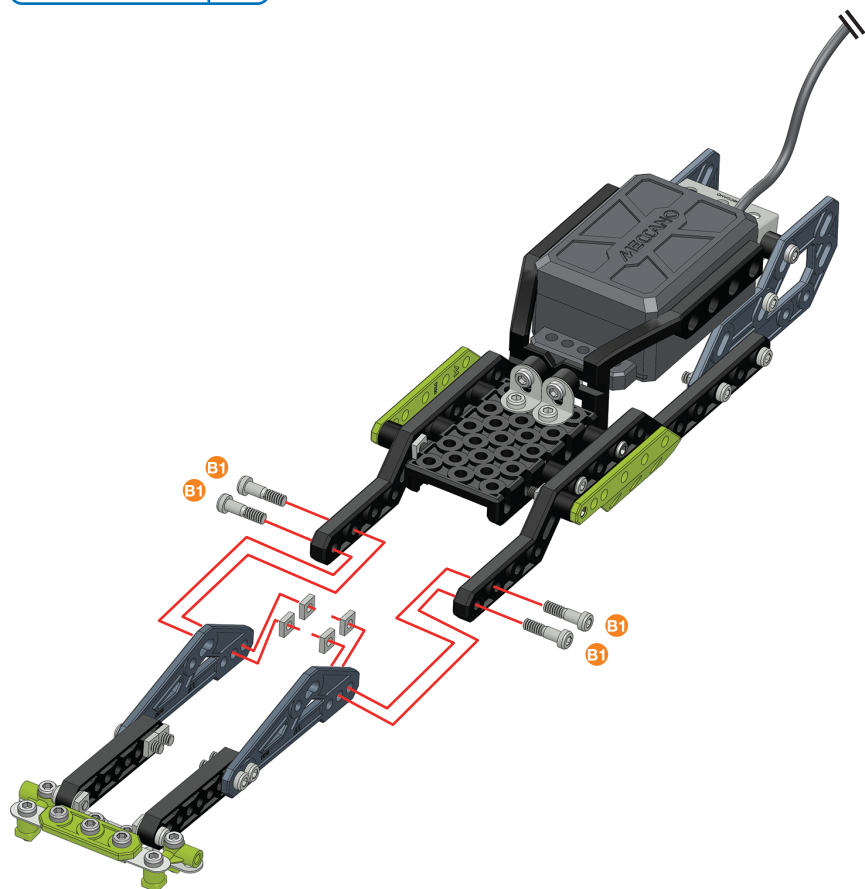

	B1	1:1
--	----	------------



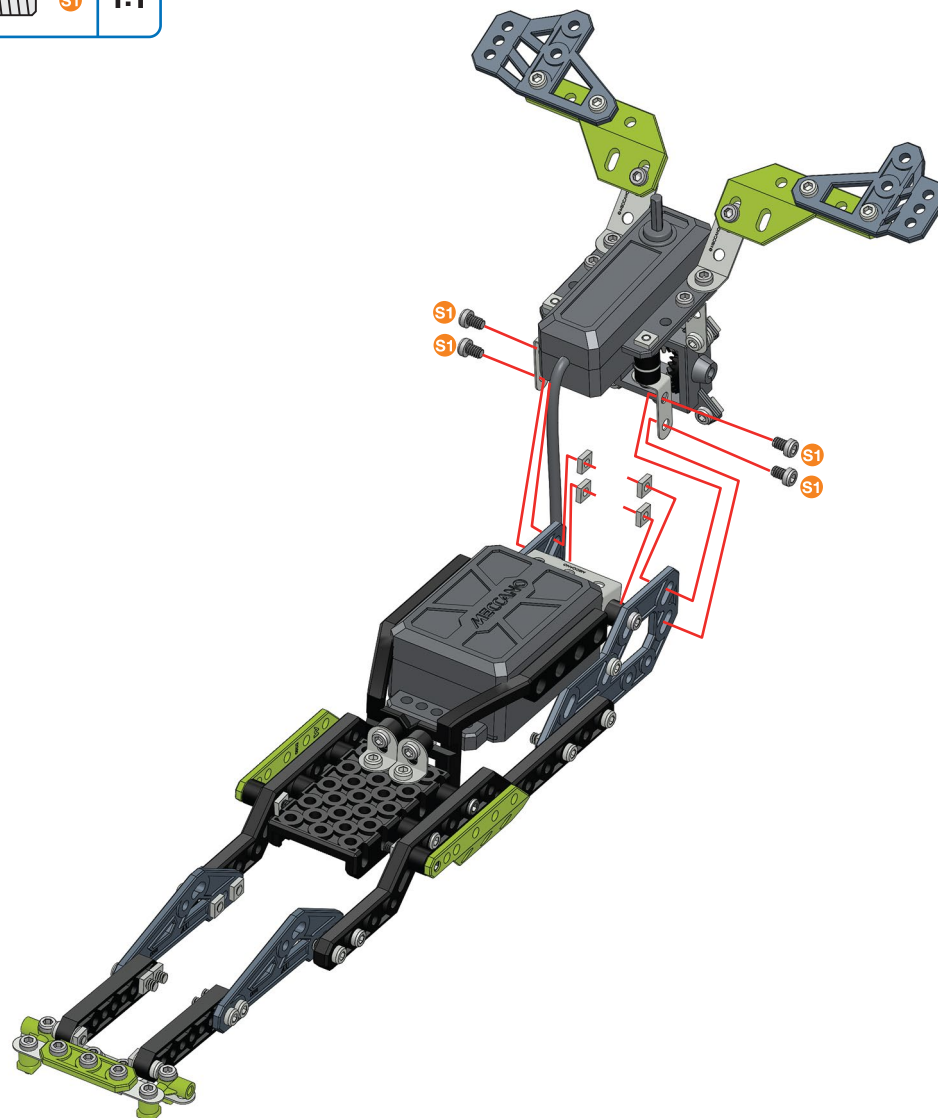

**19****5+18+**

	S1	5,8 mm 15/64 in	x4
			x4

	S1	1:1
---	----	------------



20

	12 mm 1/2 in 1/2 po	x2
		x2
		x2
		x2

	1:1
---	------------

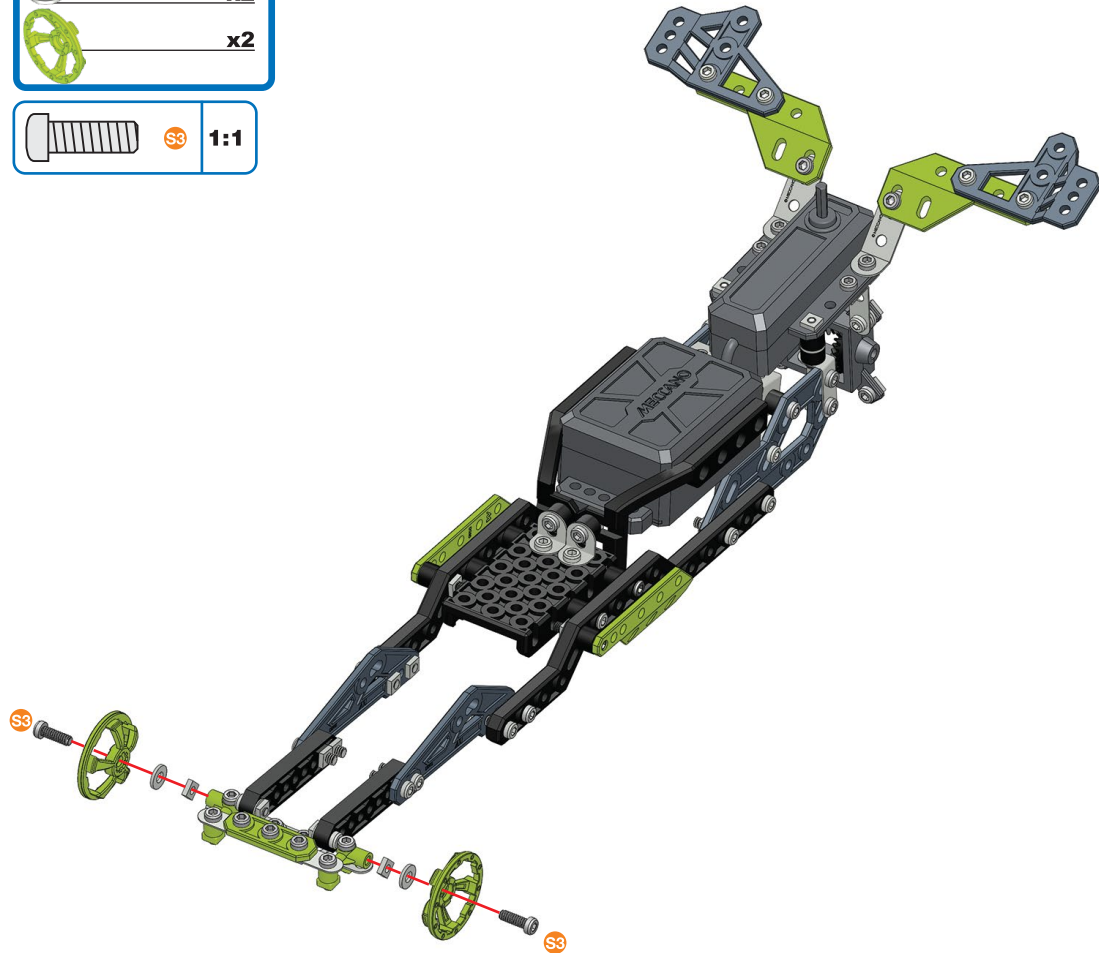

21

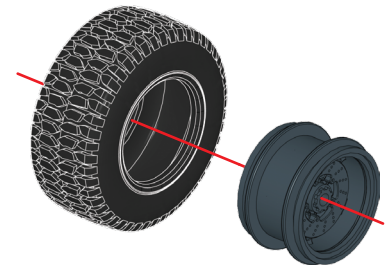

	x4
	x4

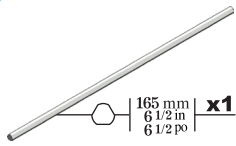

22

20+21+



-  x2
-  x4
-  x2

