

1

	12 mm 1/2 in 1/2 po	x4
		x4
		x8
		x4
		x2
		x2

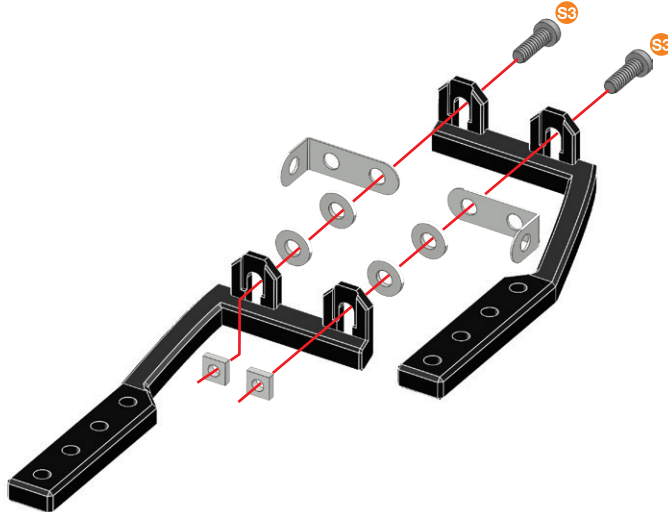

	1:1
--	------------

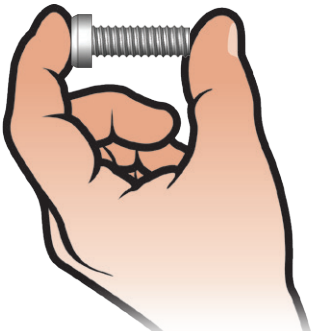

2 ①+

	14.7 mm 37/64 in 37/64 po	x2
	19 mm 3/4 in 3/4 po	x2
		x4
		x2
		x1

	1:1

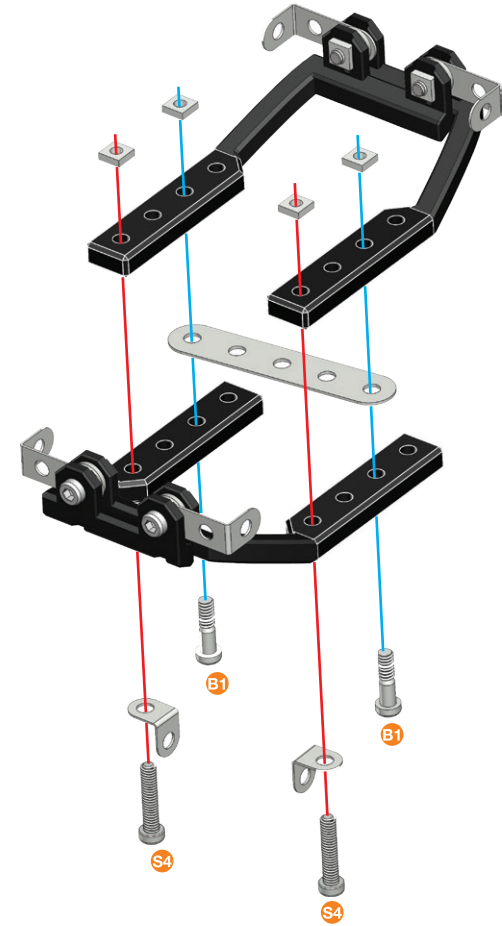

3

	5.8 mm 15/64 in 15/64 po	x1
	12 mm 1/2 in 1/2 po	x1
	14.7 mm 37/64 in 37/64 po	x1
		x3
		x3
		x1
		x1
		x1
		x1

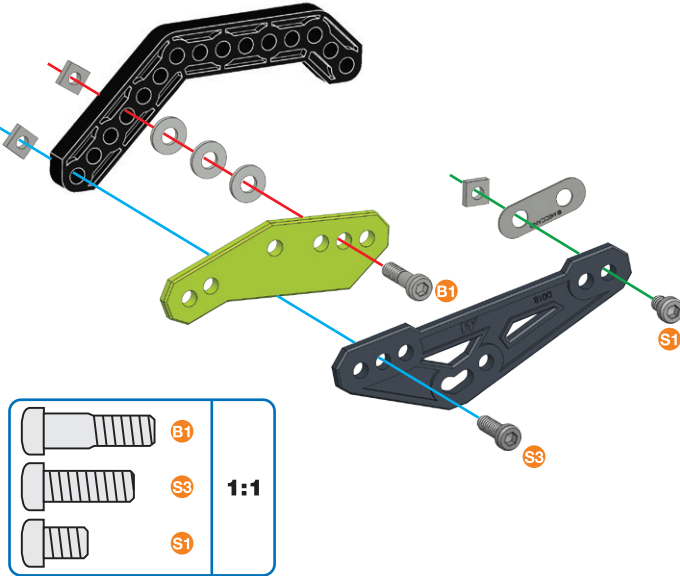

		1:1

4

	5.8 mm 15/64 in 15/64 po	x1
	12 mm 1/2 in 1/2 po	x1
	14.7 mm 37/64 in 37/64 po	x1
		x3
		x3
		x1
		x1
		x1
		x1

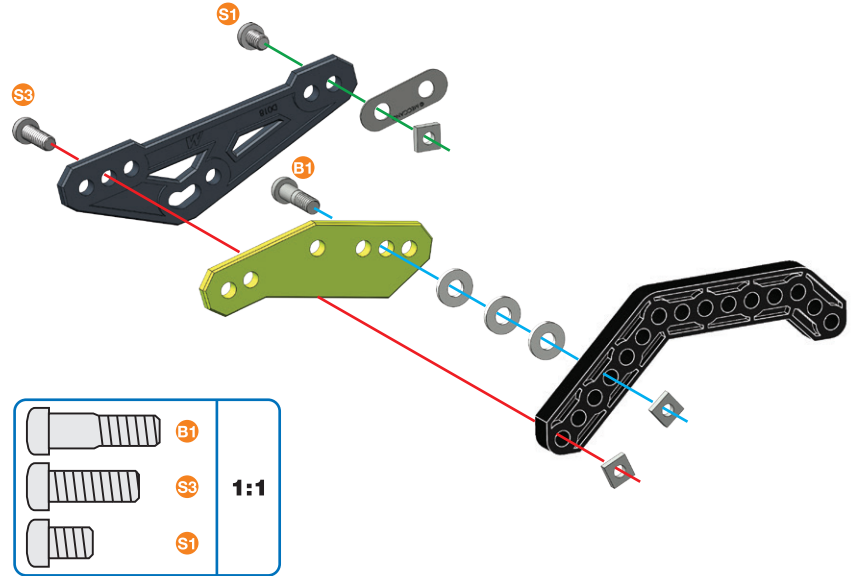

		1:1

5

②+③+④+

	9.5 mm 3/8 in 3/8 po	x2
	14.7 mm 37/64 in 37/64 po	x2
		x4
		x2

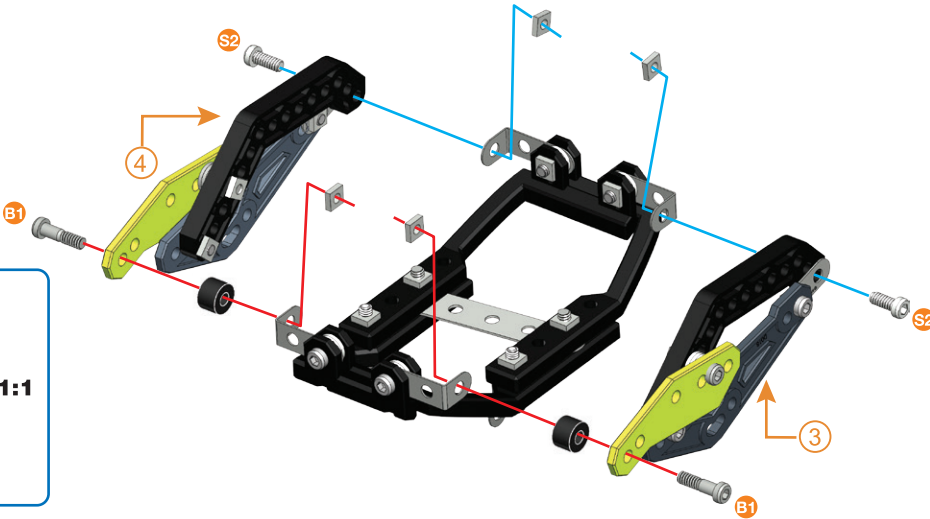

		1:1
	A238	

6

	5.8 mm 15/64 in 15/64 po	x2
		x2
		x2
		x1
		x1

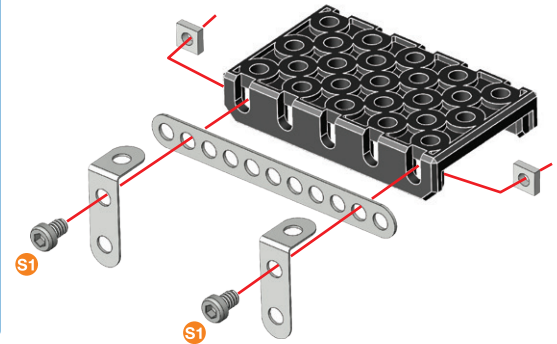

		1:1
--	--	-----

7

	9.5 mm 3/8in 3/8po	x2
		x2
		x2

	S2	1:1
--	----	-----

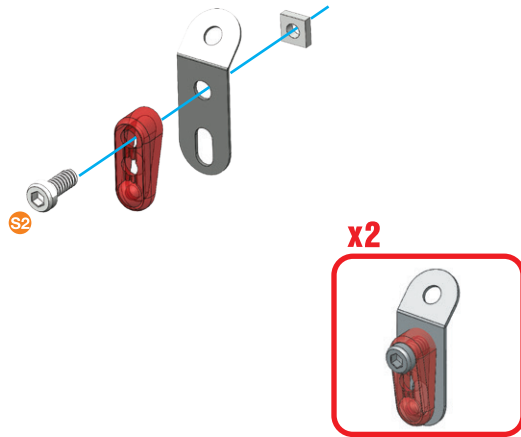

8

(5)+(6)+(7)+

	9.5 mm 3/8in 3/8po	x2
		x2

	S2	1:1
--	----	-----

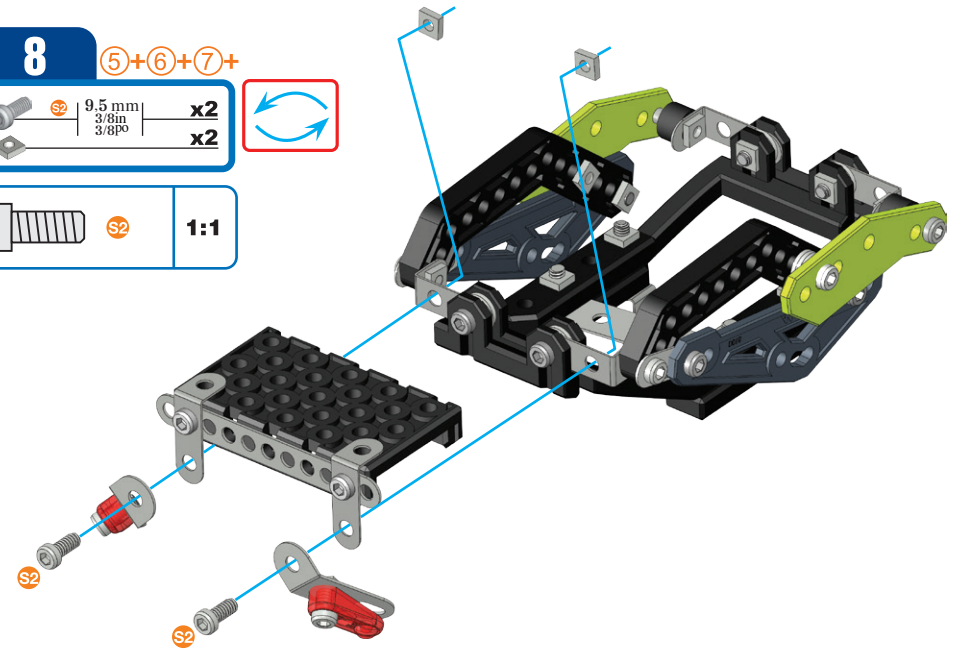

9

	9.5 mm 3/8in 3/8po	x4
		x4
		x2
		x1

	S2	1:1
--	----	-----

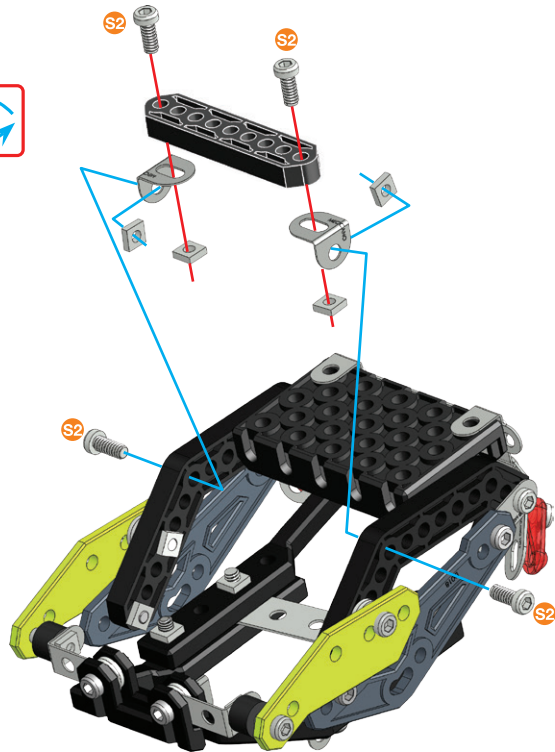



10

	9.5 mm 3/8in 3/8po	x4
		x4
		x2
		x1
		x1

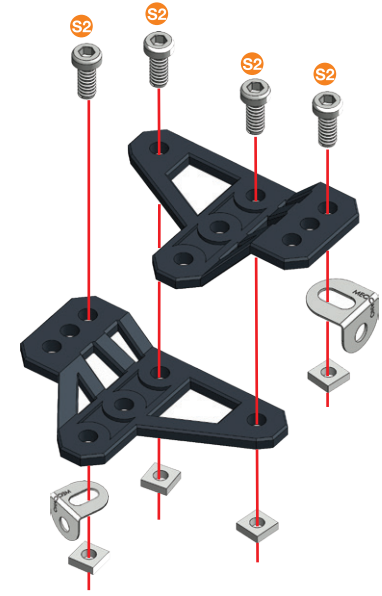
	S2	1:1
--	----	-----





11**9+10+**

	9.5 mm 3/8 in 3/8 po	x2
		x2

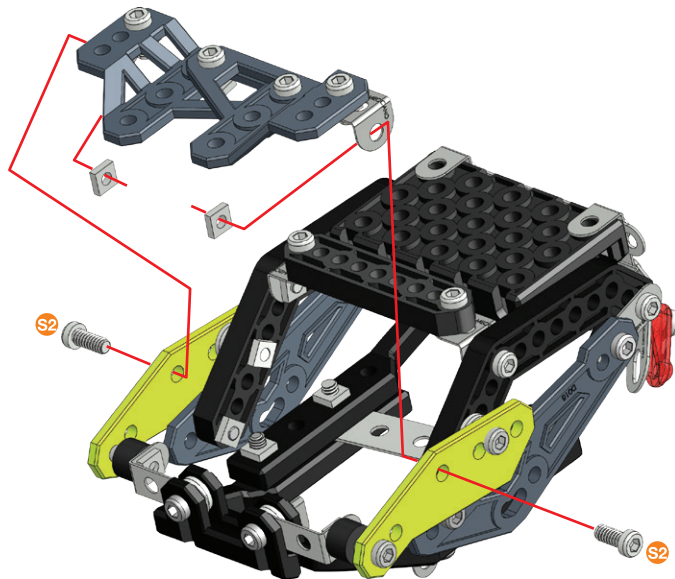
	S2	1:1
--	-----------	------------

**12**

	9.5 mm 3/8 in 3/8 po	x2
		x2

	S2	1:1
---	-----------	------------

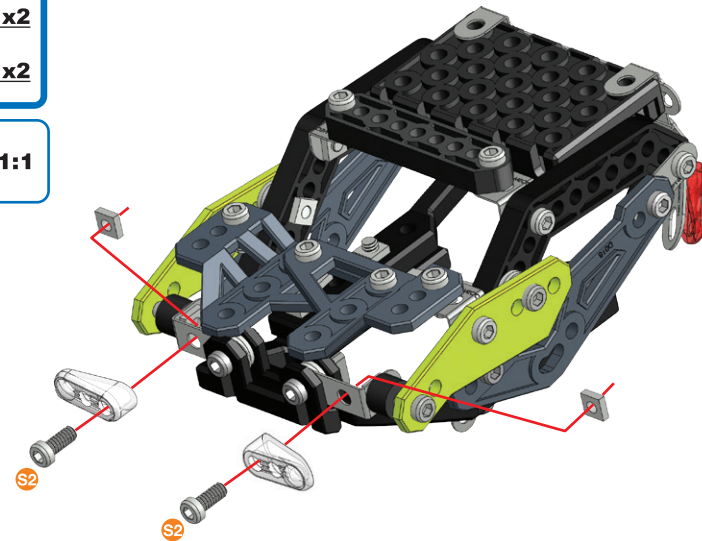
**13**

	5.8 mm 15/64 in 15/64 po	x1
--	--------------------------------	-----------

	9.5 mm 3/8 in 3/8 po	x1
---	----------------------------	-----------

	14.7 mm 37/64 in 37/64 po	x1
--	---------------------------------	-----------

		x3
--	--	-----------





		x1
--	--	-----------

		x1
--	--	-----------

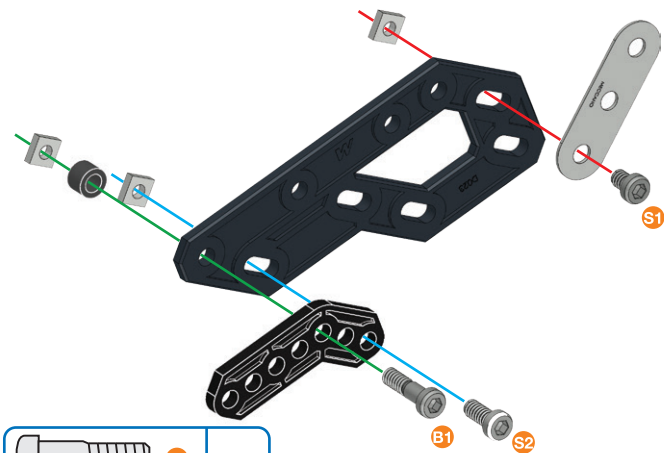
		x1
--	--	-----------

		x1
--	--	-----------





	B1	1:1
	S2	
	S1	
	A338	

14

	5.8 mm 15/64 in 15/64 po	x1
---	--------------------------------	-----------

	9.5 mm 3/8 in 3/8 po	x1
--	----------------------------	-----------

	14.7 mm 37/64 in 37/64 po	x1
---	---------------------------------	-----------

		x3
---	--	-----------





		x1
---	--	-----------

		x1
---	--	-----------

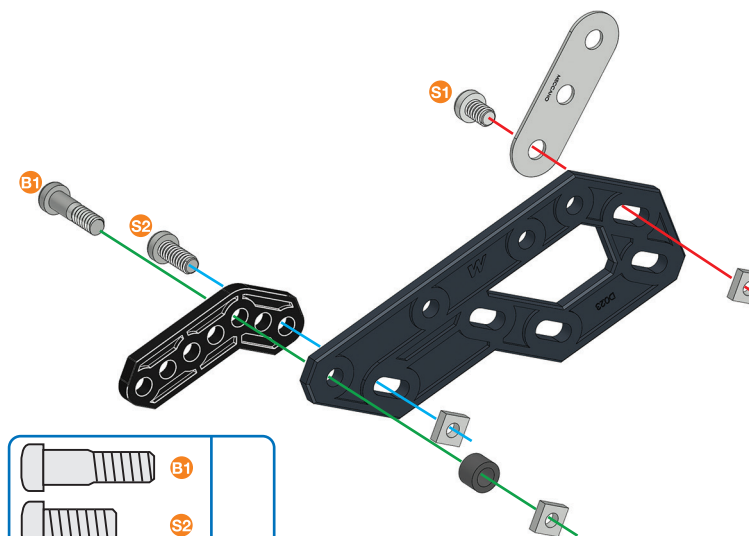

		x1
---	--	-----------

		x1
---	--	-----------



	B1	1:1
	S2	
	S1	
	A338	



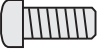

15

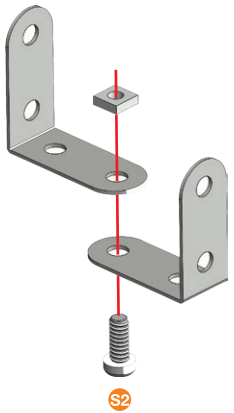
	9.5 mm 3/8 in 3/8 Po	x1
		x1
		x2

	S2	1:1
--	----	-----



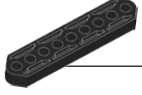

16

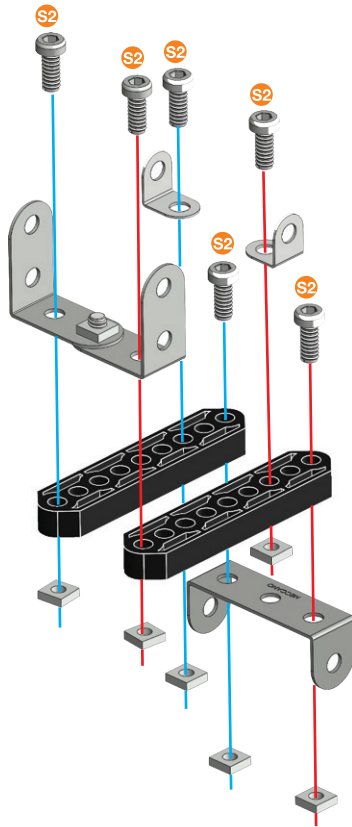

	9.5 mm 3/8 in 3/8 Po	x6
		x6
		x2
		x1
		x2

	S2	1:1
---	----	-----





17 (13)+(14)+(16)+

	9.5 mm 3/8 in 3/8 Po	x2
		x2

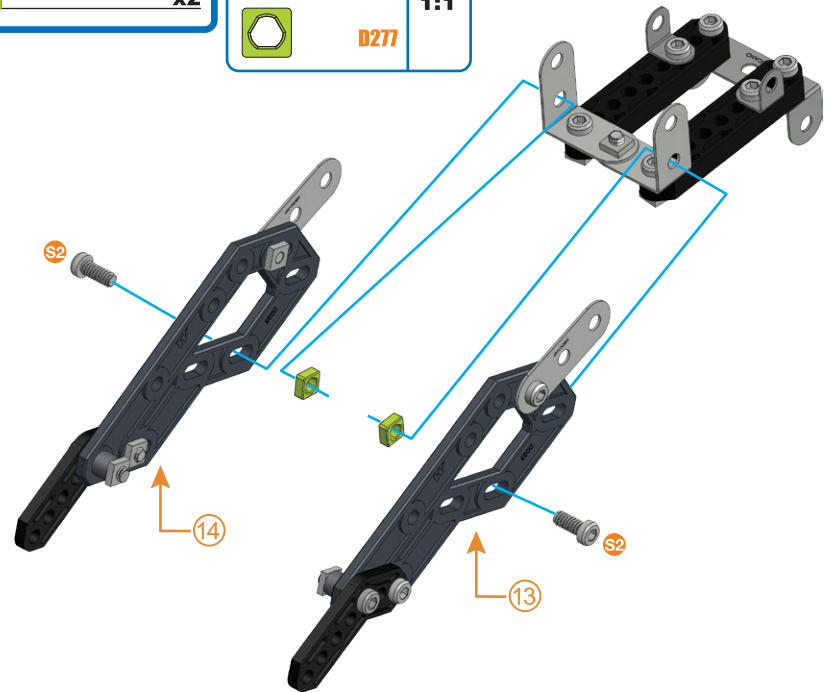
	S2	1:1
	D277	1:1

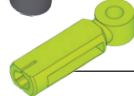

18

	x2
	x2
	x2

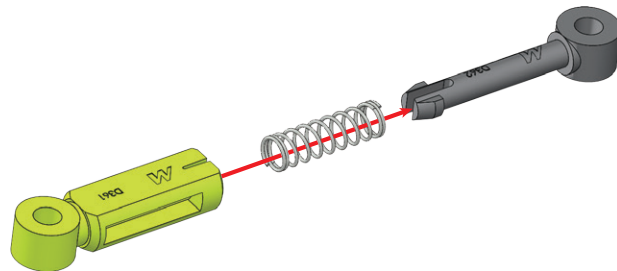

x2

19**17+18+**

	9.5 mm 3/8 in 3/8 po	x4
		x4

	S2	1:1
	D277	

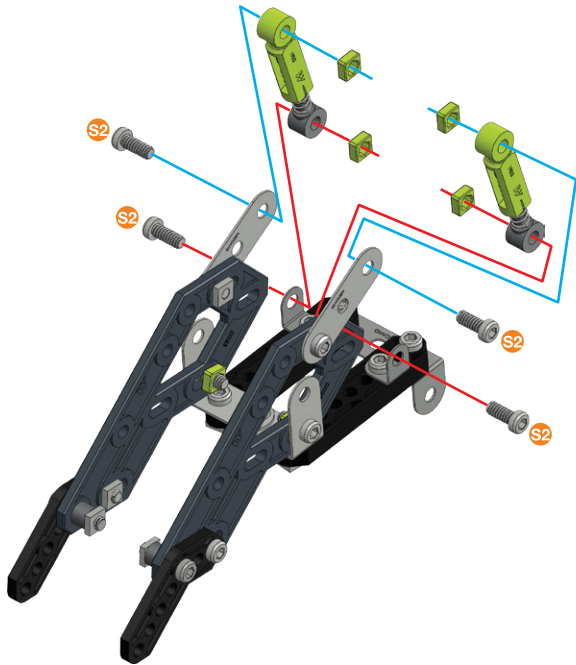
**20**

	9.5 mm 3/8 in 3/8 po	x2
		x2
		x2
		x1

	S2	1:1
--	-----------	------------

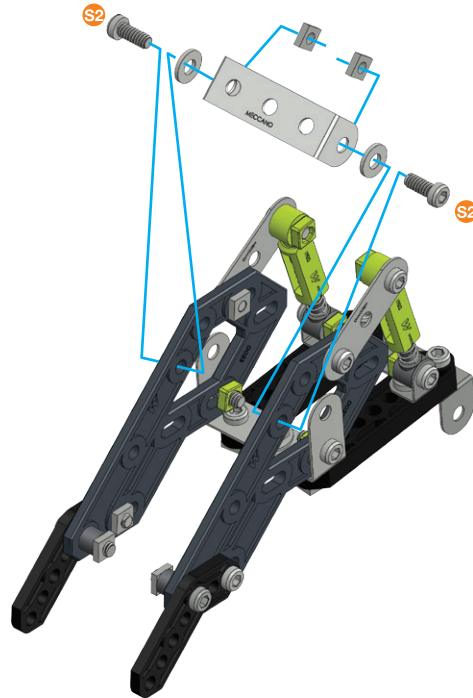
**21****12+20+**

	5.8 mm 15/64 in 15/64 po	x2
	14.7 mm 37/64 in 37/64 po	x1
		x2
		x3

	S1	1:1
	B1	
	A238	

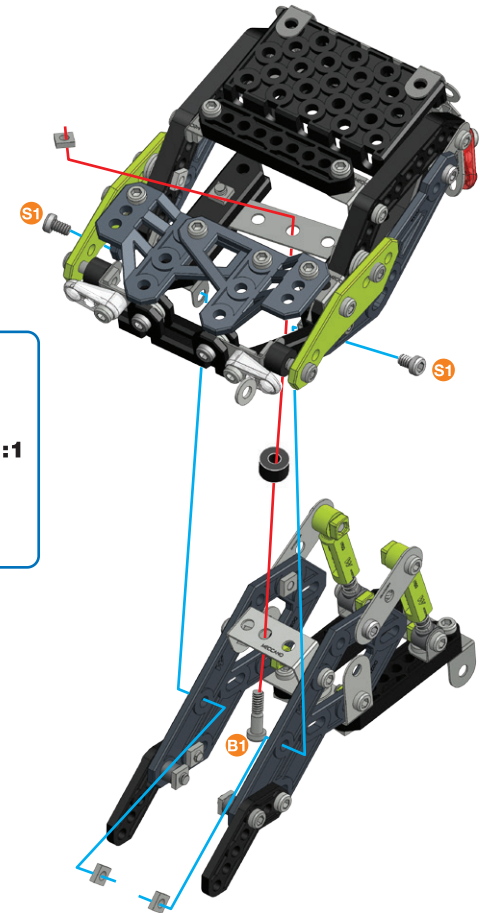

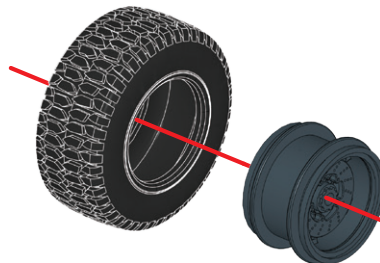

**22**

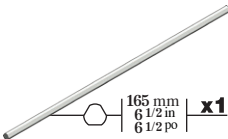

	x4
	x4

**x4**

23

21+22+

-  165 mm
6 1/2 in
6 1/2 po | **x1**
-  **x2**
-  **x2**
-  **x8**
-  **x2**

-  **A338**
-  **A238**

1:1



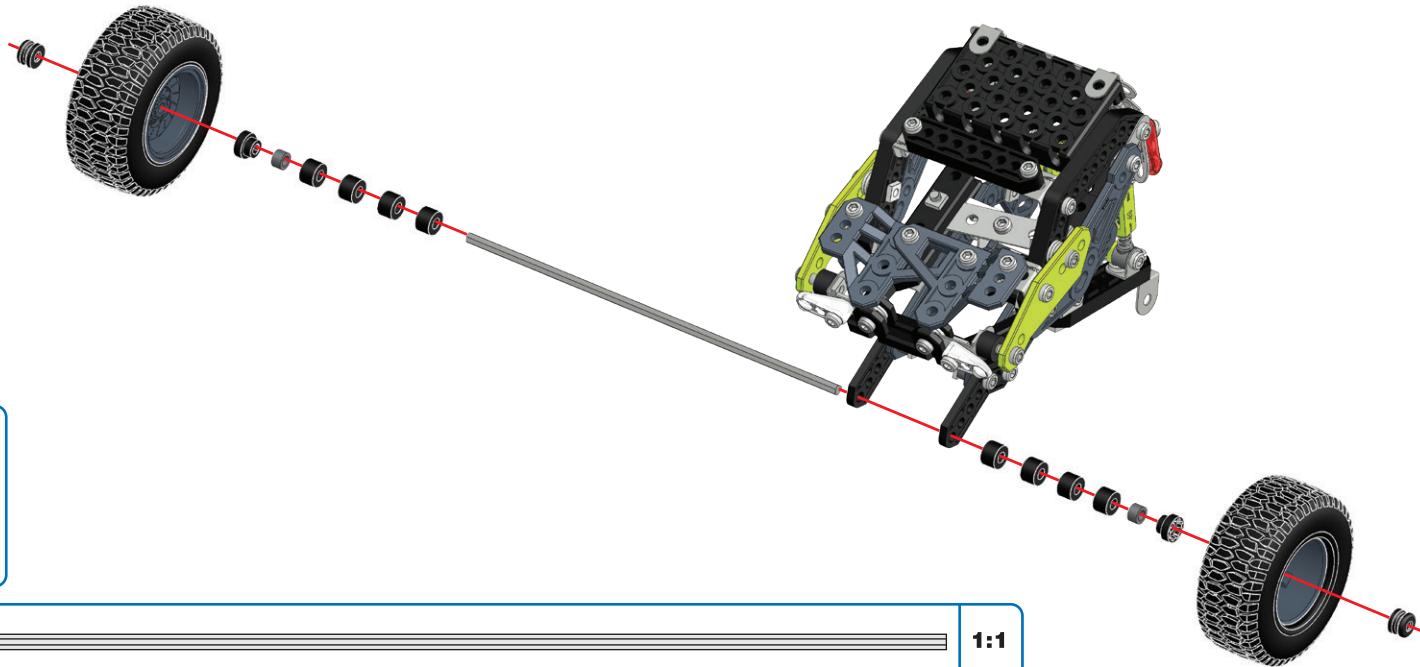

1:1

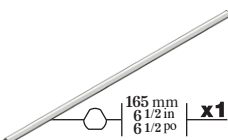

24

22+23+

-  165 mm
6 1/2 in
6 1/2 po | **x1**
-  **x2**
-  **x10**

-  **A238**

1:1



1:1

