

MECCANO[™]
ENGINEERING & ROBOTICS

8R[™] SERIES TRACTOR TRACTEUR SÉRIE 8R[™]

18302



10+

Instructions
Notice de montage
Instrucciones de
construcción
Bauanleitung
Bouwinstructie
Istruzioni
Instruções
Инструкции

Instrukcja
Pokyny
Útmutató
Instrucțiuni





CONSTRUCTION TIPS / ASTUCES DE CONSTRUCTION

TIPS DE CONSTRUCCIÓ / TIPPS ZUM BAUEN / MONTAGETIPS / SUGGERIMENTI PER COSTRUIRE

DICAS DE MONTAGEM / РЕКОМЕНДАЦИИ ПО СБОРКЕ / WSKAZÓWKI DO BUDOWANIA

KONSTRUKČNÍ TIPY / TIPY NA MONTÁŽ / ÖSSZESZERELÉSI TIPP EK / SFATURI PENTRU CONSTRUIRE

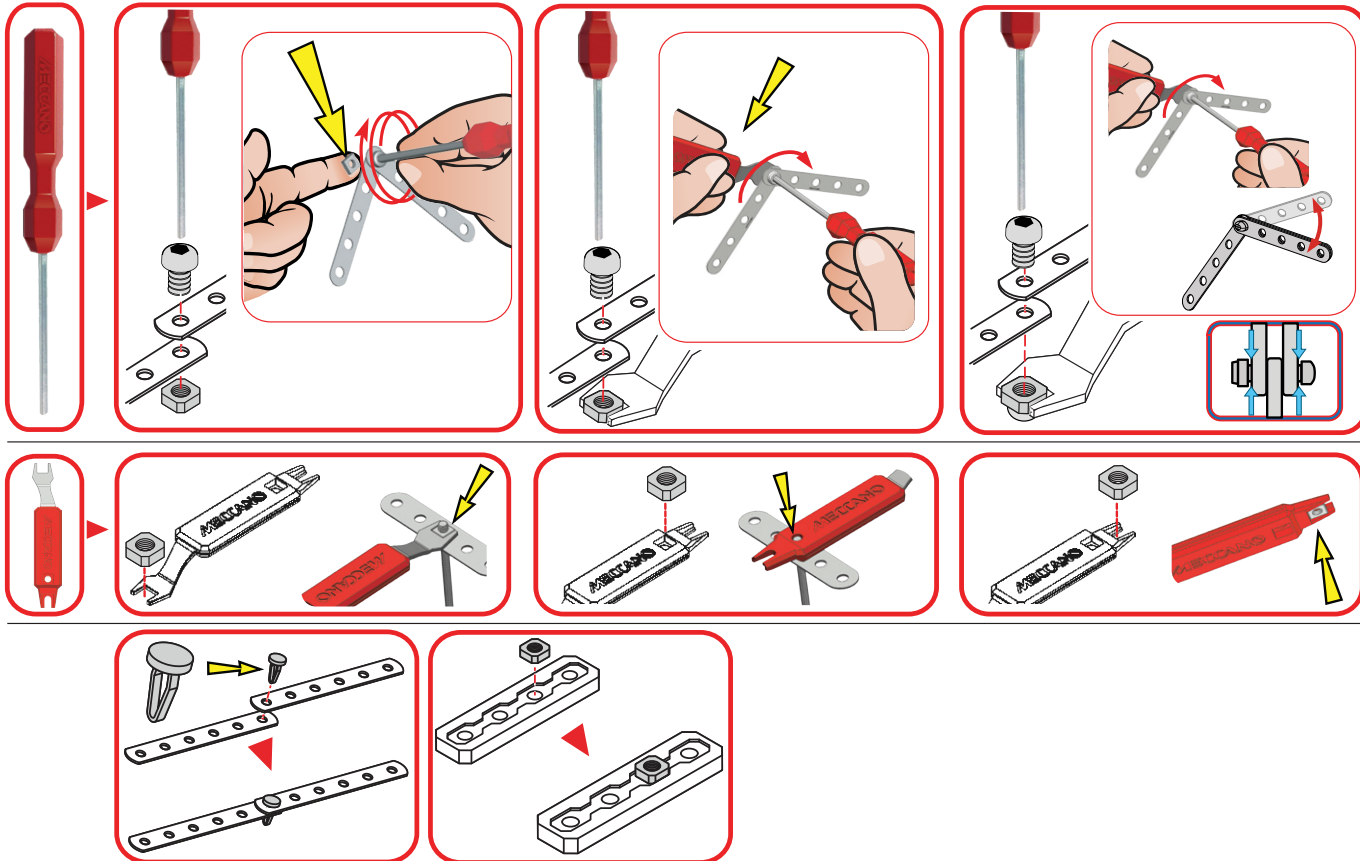

TABLE OF CONTENTS / SOMMAIRE

ÍNDICE / INHALTSVERZEICHNIS / INHOUD / INDICE / СОДЕРЖАНИЕ



SPIŠ TREŠCI / OBSAH / TARTALOMJEGYZÉK / CUPRINS



EN. Content: 240 parts, 2 real tools, 1 sticker sheet, 1 instruction sheet for 1 model.
FR. Contenu : 240 pièces, 2 vrais outils, 1 feuillet d'autocollants, 1 notice de montage pour 1 modèle.
ES. Contenido: 240 piezas, 2 herramientas reales, 1 hoja de calcomanías, 1 guía de instrucciones para 1 modelo.
DE. Inhalt: 240 Teile, 2 echte Werkzeuge, 1 Bogen mit Aufklebern, 1 Bauanleitung für 1 Modell.
NL. Inhoud: 240 onderdelen, 2 stuks gereedschap, 1 stickervel, 1 bouw instructie voor 1 model.
IT. Contenuto: 240 pezzi, 2 attrezzi, 1 foglio di adesivi, 1 guida per l'uso per 1 modello.
PT. Conteúdo: 240 peças, 2 ferramentas reais, 1 folha de adesivos, 1 folha de instruções para 1 modelo.
RU. В комплекте: 240 деталей, 2 настоящих инструмента, 1 лист с наклейками, 1 инструкция по сборке 1 модели.
PL. Zawartość: 240 elementów, 2 prawdziwe narzędzia, 1 arkusz naklejek, 1 karta z instrukcjami dla 1 modelu.
CZ. Obsah: 240 dílů, 2 skutečné nástroje, 1 list se samolepkami, 1 list s pokyny pro 1 model.
SK. Obsah: 240 dielov, 2 skutočné nástroje, 1 hárok s nálepkami, 1 hárok s pokynmi pre 1 model.
HU. Tartalom: 240 db alkatrész, 2 db valódi szerszám, 1 db matricalap, 1 db 1 modellhez tartozó felhasználói útmutató.
RO. Conținut: 240 de piese, 2 instrumente reale, 1 foaie cu autocolante 1 fișă cu instrucțiuni pentru 1 model.



1

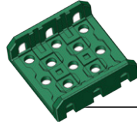

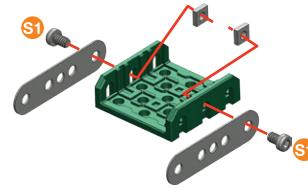
-  S1 | 5.8 mm | x2
15/64"
-  x2
-  x2
-  x1

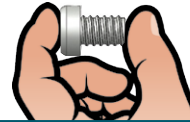

-  S1 | 1:1



2

-  S1 | 5.8 mm | x4
15/64"
-  x4
-  x4

-  S1 | 1:1

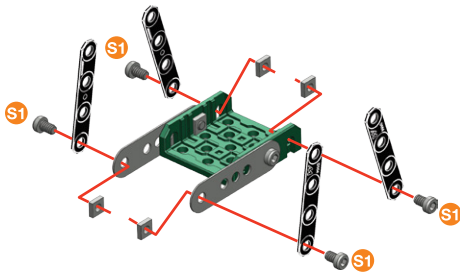



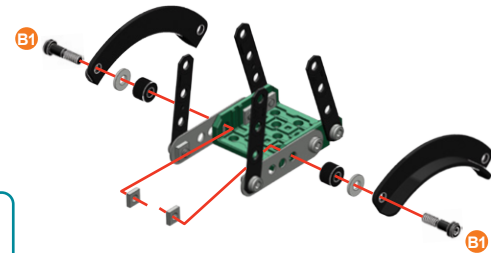

3

-  B1 | 14.7 mm | x2
37/64"
-  x2
-  x2
-  x2
-  x2

-  B1 | 1:1
-  A238
- 



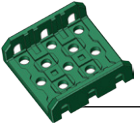

4

	12 mm 1/2"	x2
		x2
		x1
		x1
		x1

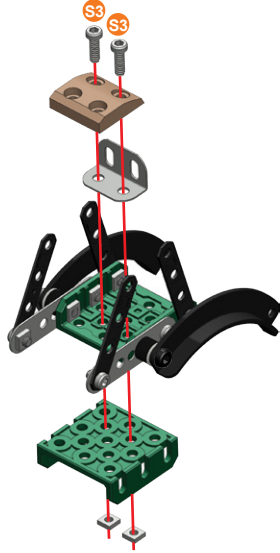
	S3	1:1
---	----	-----





5

	5.8 mm 15/64"	x2
		x2
		x1

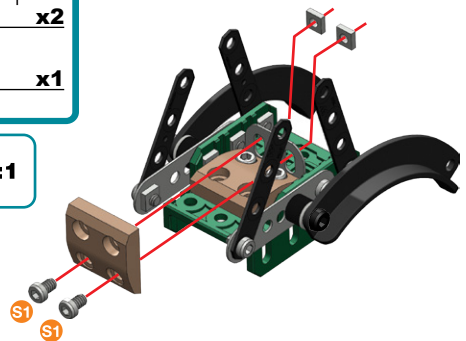
	S1	1:1
--	----	-----



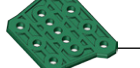

6

	9.5 mm 3/8"	x2
		x2
		x1
		x1

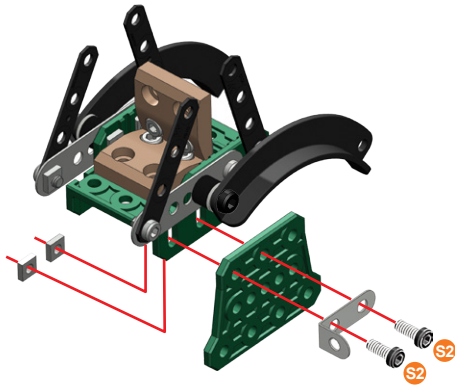
	S2	1:1
---	----	-----

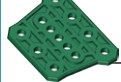

7

	9.5 mm 3/8"	x1
		x1
		x1

	S2	1:1
--	----	-----

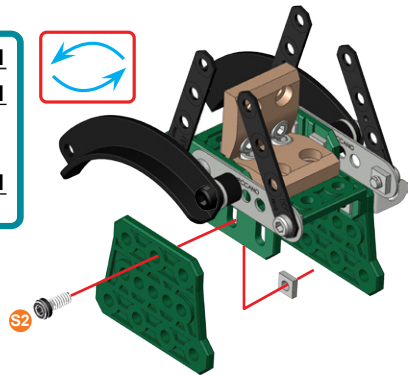



8

	19 mm 3/4"	x1
		x1
		x1
		x1
		x1

	1:1
---	-----







9

	5,8 mm 15/64"	x1
		x1
		x1

	1:1
---	-----





10

⑦+⑨+

	28 mm 1 1/8"	x2
		x2
		x2
		x1

	1:1
---	-----

11

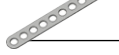
	12 mm 1/2"	x1
		x1
		x1
		x1
		x1

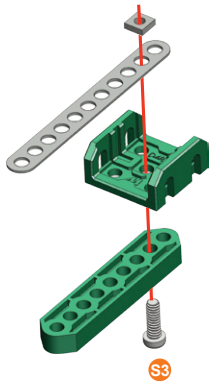

	1:1
---	-----



12

	x1
---	----



13

	14,7 mm 37/64"	x1
		x1
		x1

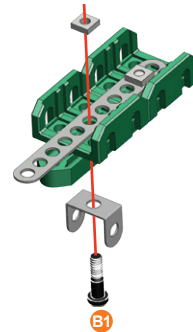
	1:1
--	-----



14

-  **S1** | 5.8 mm | **x2**
15/64"
-  **x2**
-  **x2**

-  **S1** | **1:1**

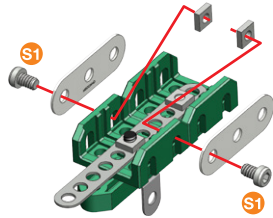

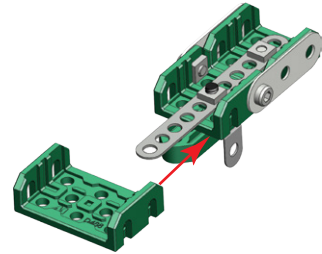

15

-  **x1**



16



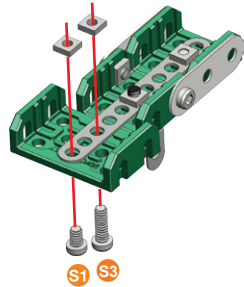

-  **S1** | 5.8 mm | **x1**
15/64"
-  **S3** | 12 mm | **x1**
1/2"
-  **x2**



-  **S1**
-  **S3** | **1:1**



17



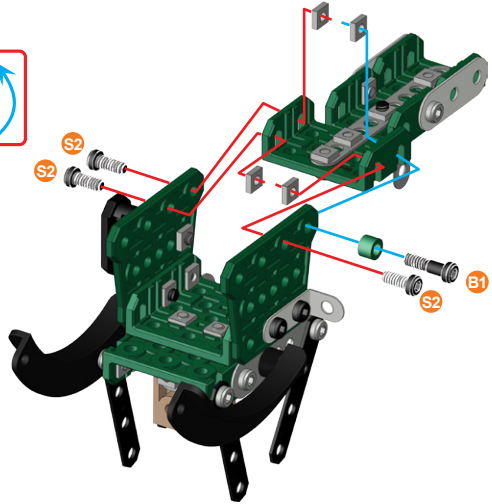

10+16+

-  **S2** | 9.5 mm | **x3**
3/8"
-  **B1** | 14.7 mm | **x1**
37/64"
-  **x4**
-  **x1**

-  **S2**
-  **B1** | **1:1**
-  **A338**



18

	14.7 mm	x2
	37/64"	x2
		x4
		x2

	A338	1:1
	B1	

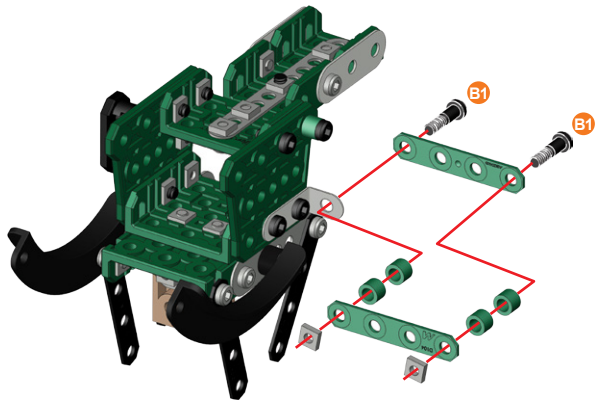

19



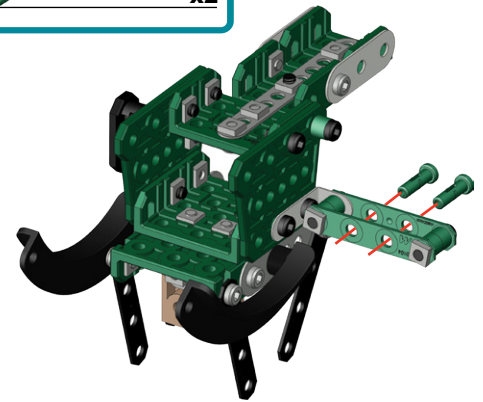

	x2
---	-----------

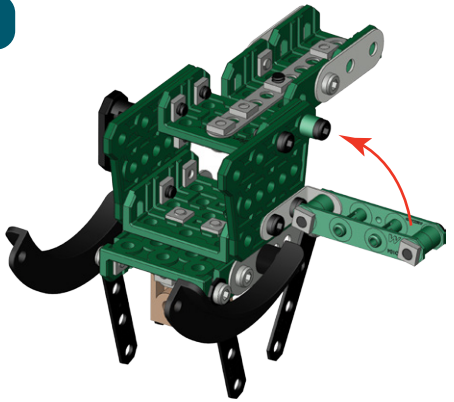



20





21

	5.8 mm	x2
	15/64"	x2
		x1
		x2

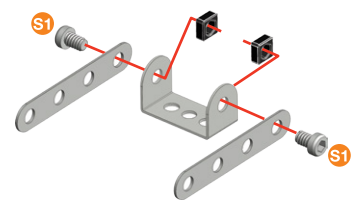



	S1	1:1
	D277	

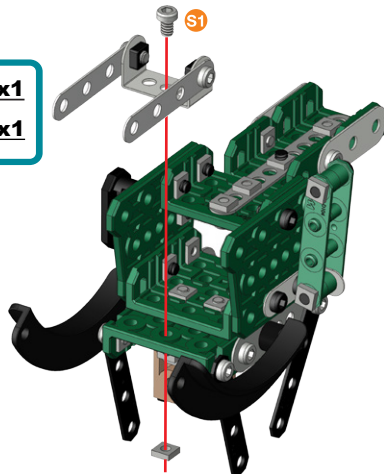

- 22** (20)+(21)+
- | | | |
|---|------------------|----|
|  | 5.8 mm
15/64" | x1 |
|  | | x1 |







- | | |
|---|-----|
|  | 1:1 |
|---|-----|

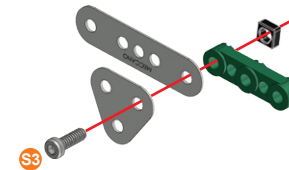



- 23**
- | | | |
|---|---------------|----|
|  | 12 mm
1/2" | x1 |
|  | | x1 |
|  | | x1 |
|  | | x1 |
|  | | x1 |

- | | | |
|---|------|-----|
|  | D277 | 1:1 |
|  | S3 | |



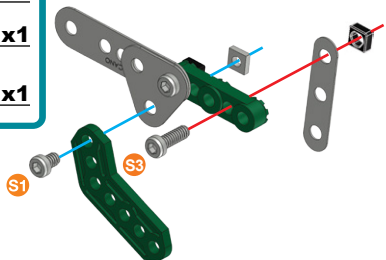

- 24**
- | | | |
|--|------------------|----|
|  | 5.8 mm
15/64" | x1 |
|  | 12 mm
1/2" | x1 |
|  | | x1 |
|  | | x1 |
|  | | x1 |
|  | | x1 |

- | | | |
|---|------|-----|
|  | D277 | 1:1 |
|  | S1 | |
|  | S3 | |







- 25** (22)+(24)+
- | | | |
|---|-------------------|----|
|  | 5.8 mm
15/64" | x1 |
|  | 12 mm
1/2" | x1 |
|  | 13.05mm
33/64" | x1 |
|  | | x2 |
|  | | x1 |

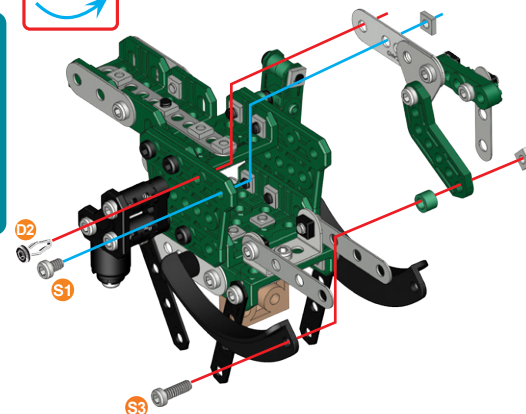



- | | | |
|---|----|-----|
|  | S1 | 1:1 |
|  | D2 | |
|  | S3 | |







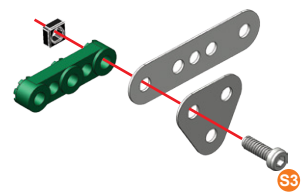

26



-  S3 | 12 mm | x1
-  S3 | 1/2" | x1
-  | x1
-  | x1
-  | x1

-  D27
 -  S3
- 1:1



27





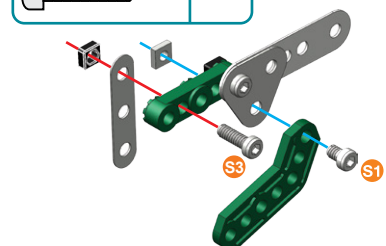

-  S1 | 5.8 mm | x1
-  S3 | 15/64" | x1
-  S3 | 12 mm | x1
-  | x1
-  | x1
-  | x1
-  | x1

-  D27
 -  S1
 -  S3
- 1:1







28

(25)+(27)+



-  S1 | 5.8 mm | x1
-  S3 | 12 mm | x1
-  D2 | 13.5mm | x1
-  D2 | 33/64" | x1
-  | x2
-  | x1



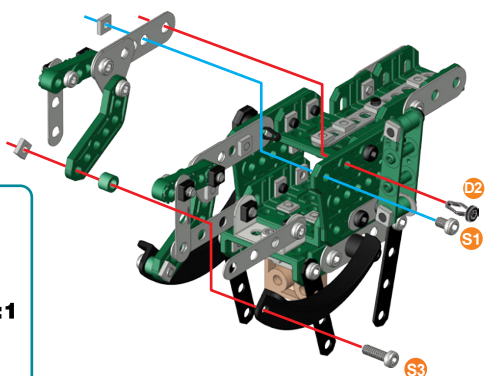

-  S1
 -  D2
 -  S3
 -  | A338
- 1:1







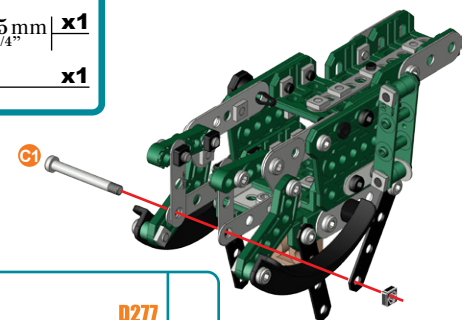

29

-  C1 | 31.75 mm | x1
-  | x1

-  D27
 -  C1
- 1:1





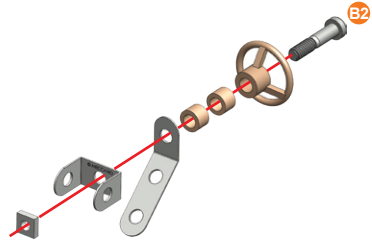

30

-  **B2** | 19 mm | **x1**
3/4"
-  **x1**
-  **x2**
-  **x1**
-  **x1**
-  **x1**

-  **S1** | **1:1**





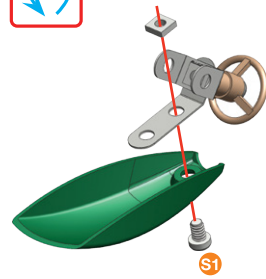

31

-  **S1** | 5.8 mm | **x1**
15/64"
-  **x1**
-  **x1**
-  **x1**

-  **S1** | **1:1**



32

-  **S2** | 9.5 mm | **x2**
3/8"
-  **x2**
-  **x2**
-  **x2**

-  **S2** | **1:1**

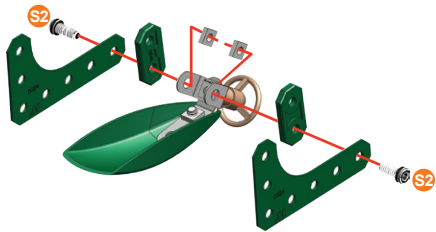

33

-  **D1** | 11.25mm | **x2**
7/16"
-  **x1**

-  **D1** | **1:1**

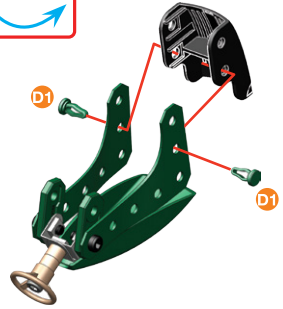
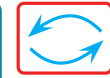

34

	9.5 mm 3/8"	x2
		x2
		x2

	1:1
--	-----

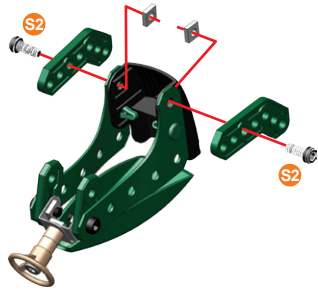

35

(29)+(34)+

	9.5 mm 3/8"	x2
	11.25 mm 7/16"	x2
		x2

	1:1

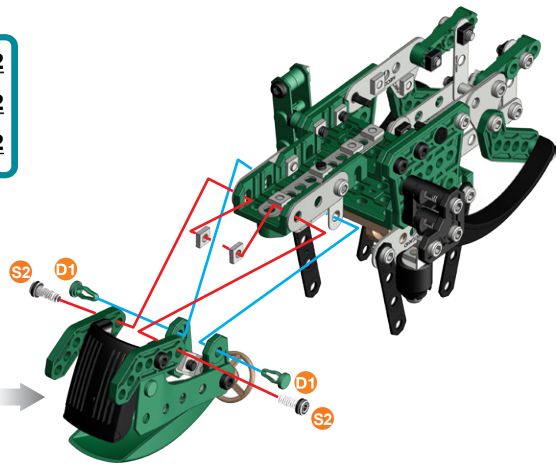
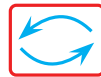

36

	5.8 mm 15/64"	x2
		x2
		x2
		x1

	1:1
--	-----

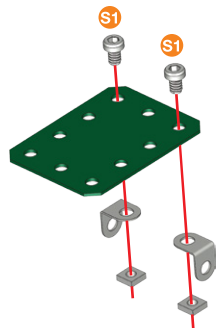

37

	9.5 mm 3/8"	x2
		x2
		x2
		x2

	1:1
	A338

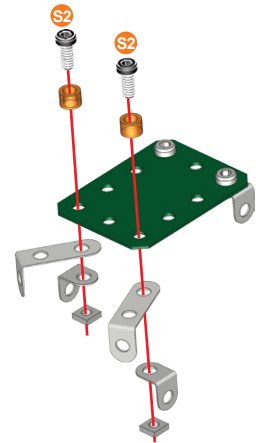

38

-  **D1** | 11.25mm | **x1**
7/16" | **x1**

-  **D1** | **1:1**

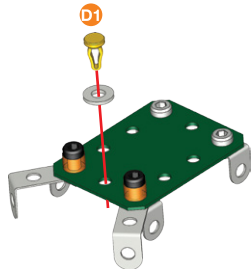

39





35+38+

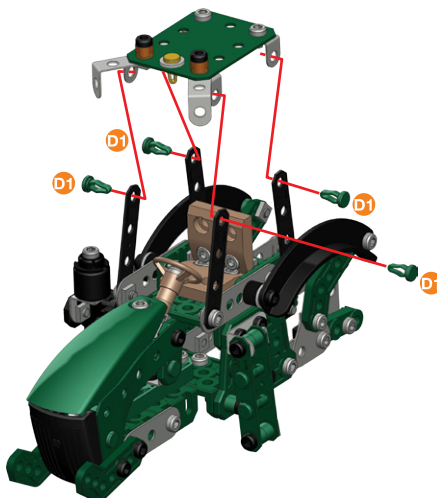

-  **D1** | 11.25mm | **x4**
7/16" | **x4**

-  **D1** | **1:1**



40

-  **B3** | 23 mm | **x1**
1 5/16" | **x1**
-  **x2**
-  **x1**
-  **x1**
-  **x1**

-  **B3**
-  **A338**
-  **1:1**



41

39+40+

-  **x1**

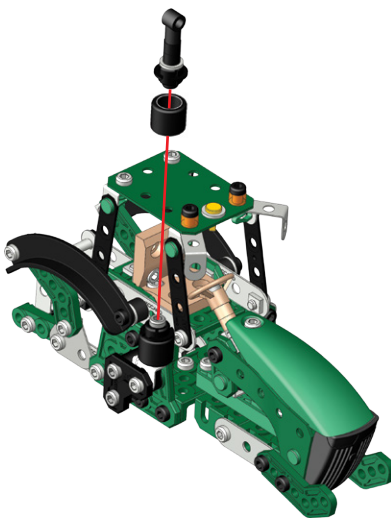

42

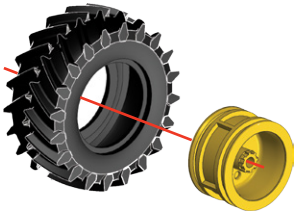

43

(41)+(42)+

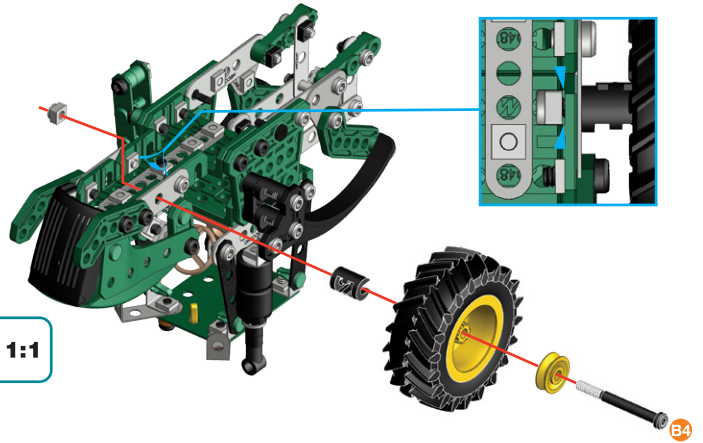
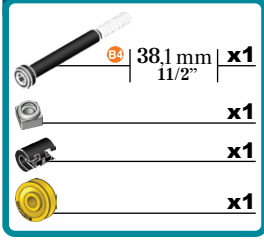

44

(42)+(43)+

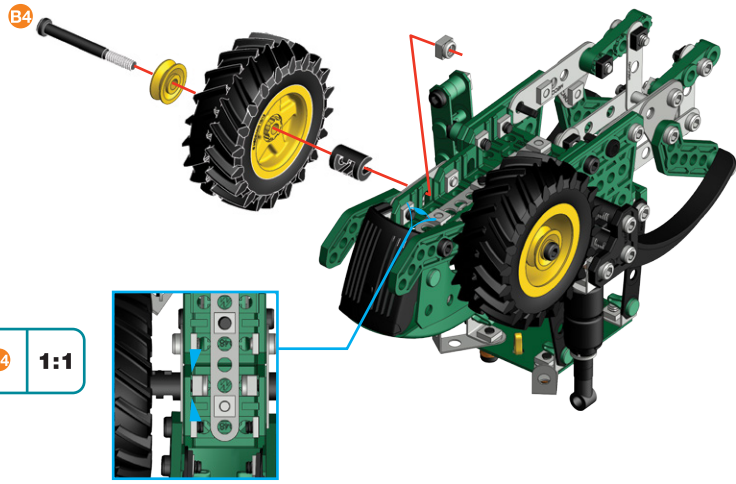
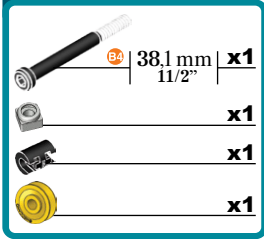

45

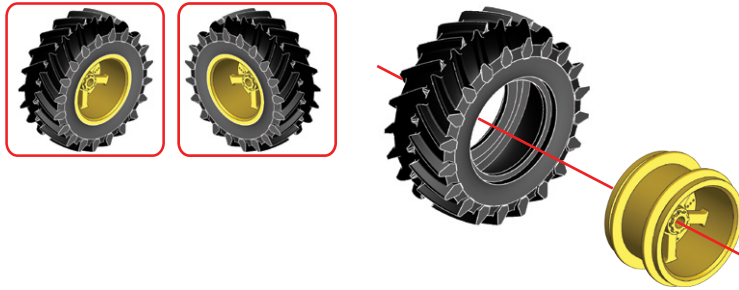

46

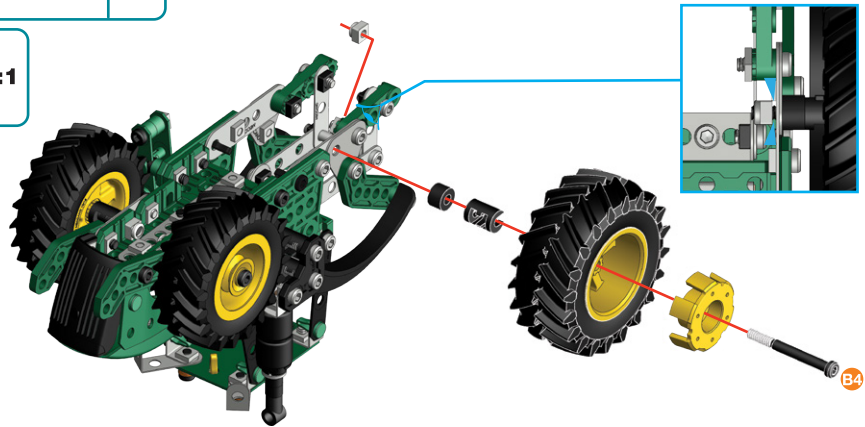
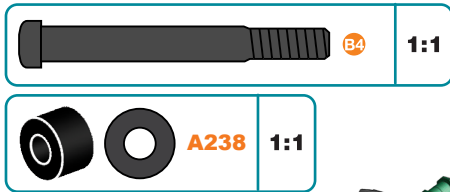

(44)+(45)+

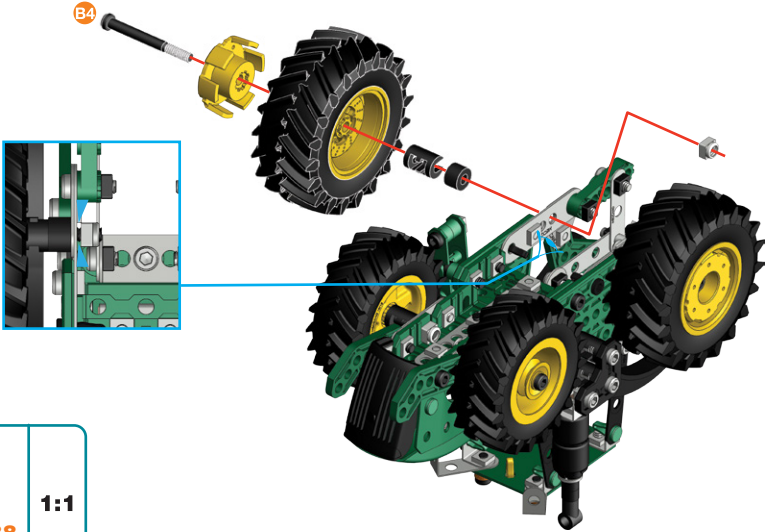

47 (45)+(46)+

	B4 38,1 mm 1 1/2"	x1
		x1
		x1
		x1
		x1



	B4	1:1
 	A238	

48

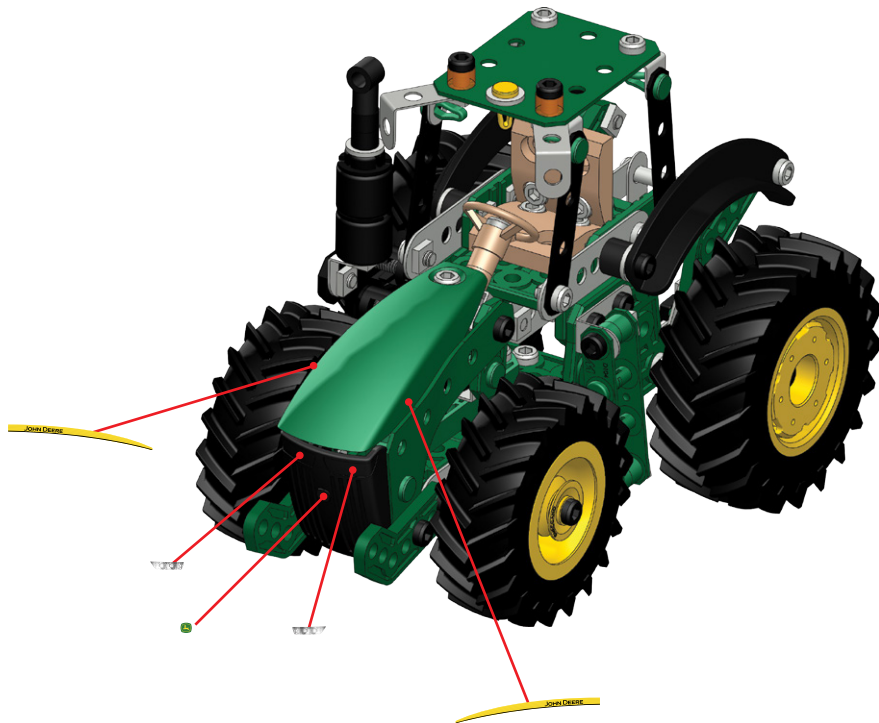
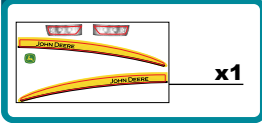

	A337 x50		C330 x4		D487 x2
	A737 x4		A012 x1		D356 x2
	A138 x4		A811 x2		D332 x1
	A338 x2		A548 x1		D444 x1
	A338 x2		A812 x3		D472(M230) x2
	A338 x7		A437 x1		D488 x1
	A238 x4		A309 x1		D485 x2
	A545 x2		A277 x2		D324 x2
	B031 x2		A416 x2		C109 x1
	D277 x7		A506 x2		C882 x2
	C863 x1		A417 x2		D564 x2
	D292 x6		D104 x2		D565 x2
	C868 x1		D104 x4		
	A524 x2		C772 x1		
	A321 x1		B146 x4		
	D563 x2		C901 x2		
	D373 x1		D424 x2		
	D048 x2				
	A420 x2				
	B051 x1				
	A260 x4				

		A421 x2
	D1	D005 x8
	D1	D005 x1
	D2	D047 x2
	S1	A637 x22
	S2	A511 x14
	S3	A411 x10
	B1	A247 x6
	B2	A447 x2
	B3	A347 x1
	S6	A611 x2
	C1	C935 x1
	B4	B696 x4
		x1
		C994 x1
		D499 x1

EN. Remove all packaging before use. Retain this information, addresses and phone numbers for future reference. Content may vary from pictures. An adult should periodically check this toy to ensure no damage or hazards exist, if so, remove from use. Children should be supervised during play. Adult supervision advised. Meccano reserves the right to discontinue use of the www.meccano.com website at any time.

FR. Retirer tout l'emballage avant utilisation. Conserver les informations, adresses et numéros de téléphone pour consultation ultérieure. Le contenu peut différer des images. Un adulte doit régulièrement examiner ce jouet afin de s'assurer qu'il ne présente pas de dommage ni de risque. En cas de problème, ne plus l'utiliser. Les enfants doivent être surveillés lorsqu'ils jouent. Surveillance d'un adulte conseillée. Meccano se réserve le droit de supprimer le site Internet www.meccano.com à tout moment.

ES. Retire todo el embalaje antes de utilizar el producto. Conserve toda la información, las direcciones y los números de teléfono para futuras referencias. El contenido del paquete puede no corresponder con las imágenes. Un adulto debe revisar de forma periódica el juguete para asegurarse de que no supone un riesgo para el niño; si así fuera el caso, interrumpa su uso. Supervise a los niños mientras juegan con el producto. Se recomienda la vigilancia de un adulto.

DE. Entfernen Sie vor der Benutzung sämtliche Verpackungsmaterialien. Alle Informationen, Adressen und Telefonnummern bitte für mögliche Rückfragen aufbewahren. Der Packungsinhalt kann von den Bildern abweichen. Ein Erwachsener sollte regelmäßig sicherstellen, dass das Spielzeug keine Gefahr darstellt, und es gegebenenfalls entfernen. Kinder sollten beim Spielen beaufsichtigt werden. Beaufsichtigung durch Erwachsene empfohlen.

NL. Verwijder de verpakking voor gebruik. Bewaar deze informatie, adressen en telefoonnummers voor toekomstig gebruik. Inhoud kan afwijken van illustraties. Een volwassene dient dit speelgoed regelmatig te controleren. In geval van schade of gevaren het speelgoed niet meer gebruiken. Houd toezicht als kinderen spelen. Toezicht door een volwassene aanbevolen.

IT. Rimuovere l'imballo prima dell'uso. Conservare informazioni, indirizzi e numeri di telefono per riferimento futuro. Il prodotto potrebbe essere differente dalle immagini. Il giocattolo deve essere periodicamente controllato da un adulto per prevenire eventuali danni o rischi; in caso di danno, sospendere l'uso. I bambini devono essere sorvegliati durante il gioco. Si raccomanda la sorveglianza di un adulto.

PT. Remova totalmente a embalagem antes de utilizar. Guarde todos os endereços, números de telefone e demais informações para consulta e referência. O conteúdo poderá ser diferente das ilustrações. Um adulto deve verificar o brinquedo periodicamente para garantir que não há danos ou riscos. Se houver, é necessário que o brinquedo seja retirado de uso. As crianças devem ser supervisionadas enquanto brincam. Recomendada a vigilância por adultos.

RU. Снимите все упаковочные материалы перед использованием. Запишите указанные на упаковке адреса и номера телефонов, чтобы у вас была возможность связаться с нами. Содержимое упаковки может отличаться от иллюстраций. Взрослым следует время от времени проверять игру и следить за тем, чтобы она не была сломана и не представляла опасности для ребенка. В противном случае ее не следует использовать. Во время игры дети должны находиться под присмотром. Рекомендуется присмотр взрослых.

PL. Przed użyciem wyjąć zabawkę z opakowania. Zachować niniejsze informacje, adresy i numery telefonów na wypadek, gdyby były potrzebne w przyszłości. Zawartość opakowania może różnić się od zabawki przedstawionej na obrazkach. Osoba dorosła powinna regularnie sprawdzać zabawkę pod kątem uszkodzeń oraz zagrożeń. Jeśli takowe wystąpią, należy zaprzestać używania zabawki. Dzieci nie powinny bawić się bez nadzoru. Dzieci powinni być nadzorowane przez osobę dorosłą.

CZ. Před použitím odstraňte veškeré balicí materiály. Uložte si tyto informace, adresy a telefonní čísla pro budoucí použití. Obsah se může lišit od obrázků. Dospělá osoba by měla pravidelně kontrolovat, zda hračka není poškozená nebo zda nepředstavuje nebezpečí. Pokud ano, hračku vyhodte. Během hry nenechávejte děti bez dozoru. Doporučujeme dohled dospělého.

SK. Pred použitím odstráňte všetok obalový materiál. Tieto informácie, adresy a telefónne čísla si uchovajte na ďalšie použitie. Obsah sa môže líšiť od zobrazenia. Túto hračku musí pravidelne kontrolovať dospelá osoba, aby sa uistila, že nedošlo k jej poškodeniu a že nehrozí žiadne nebezpečenstvo. Ak áno, ukončite jej používanie. Deti nesmú byť pri hre bez dozoru. Odporúča sa dozor dospelého.

HU. Használat előtt távolítsd el minden csomagolóanyagot. A tudnivalókat, a címet és a telefonszámot őrizze meg későbbi használatra. A csomag tartalma eltérhet a képen látottaktól. A felhívőeknek rendszeresen ellenőrizniük kell, hogy a játékon nincs-e sérülés, illetve nem jelent-e veszélyforrást. Ha igen, ki kell vonni a használatból. A gyemeket játék közben felügyeletet igényelnek. Felhívő felügyeletet javasolt.

RO. Îndepărtați toate ambalajele înainte de utilizare. Păstrați aceste informații, adresele și numerele de telefon pentru consultare ulterioară. Conținutul poate fi diferit de imaginea din fotografiile. Această jucărie trebuie verificată periodic de un adult pentru a se asigura că nu există nicio deteriorare sau niciun pericol; dacă există, scoateți jucăria din uz. Copiii trebuie supravegheați în timp ce se joacă. Se recomandă supravegherea de către adulți.

©2017 Deere & Company. John Deere's green and yellow color scheme, the leaping deer symbol, and JOHN DEERE are trademarks of Deere & Company. All rights reserved. / Le code couleur jaune et vert John Deere, son symbole du cerf bondissant et JOHN DEERE sont des marques déposées de Deere & Company. Tous droits réservés.

LP69984

8R SERIES TRACTOR / TRACTEUR SÉRIE 8R

TM & © 2018 MECCANO for packaging, instructions and models built with this set. * MECCANO is an exclusive trademark of MECCANO. Spin Master logo is a trademark of Spin Master Ltd. All rights reserved. / TM & © 2018 MECCANO pour l'emballage, les notices et modèles de ce coffret. * MECCANO est une marque de commerce exclusive de MECCANO. Le logo de Spin Master est une marque de commerce de Spin Master Ltd. Tous droits réservés.

SPIN MASTER LTD., 225 KING STREET WEST, TORONTO, ON M5V 3M2 CANADA.



	UK – 0800 206 1191, serviceuk@spinmaster.com	ITALIA – 800 788 532, servizio@spinmaster.com
	IRELAND – 1800 992 249	MÉXICO – 55 4160 7947, servicio@spinmaster.com
	FRANCE – 0800 909 150, servicefr@spinmaster.com	POLSKA – 800080238, poland@spinmaster.com
	AUSTRALIA – 1800 316 982, customercare@spinmaster.com	ČESKÁ REPUBLIKA – 800550530, czechrepublic@spinmaster.com
	DEUTSCHLAND – 00800 0101 0222, kundenservice@spinmaster.com	SLOVENSKO – 0800232800, slovakia@spinmaster.com
	SCHWEIZ – 0800 561 350 • ÖSTERREICH – 0800 297 267	MAGYARORSZÁG – 080 100 052, hungary@spinmaster.com
	NETERLAND – 0800 022 3683, klantenservice@spinmaster.com	ROMANIA – 0800400015, romania@spinmaster.com
	BELGIË/BELGIQUE – 0800 77 688 • LUXEMBOURG – 800 2 8044	
	NORTH AMERICA • AMÉRIQUE DU NORD 1-800-622-8339, CUSTOMERCARE@SPINMASTER.COM	WWW.SPINMASTER.COM