

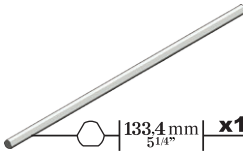



1



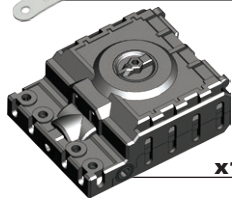
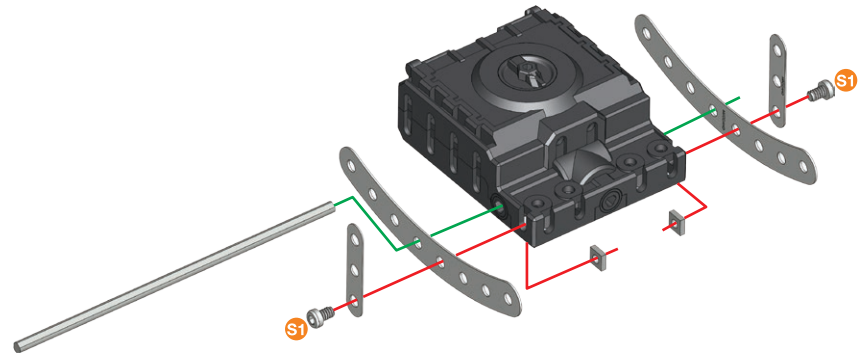

-  133.4 mm | 5 1/4" | x1
-  S1 | 5.8 mm | 15/64" | x2
-  x2
-  x2
-  x2
-  x1

-  S1 | 1:1





-  1:1

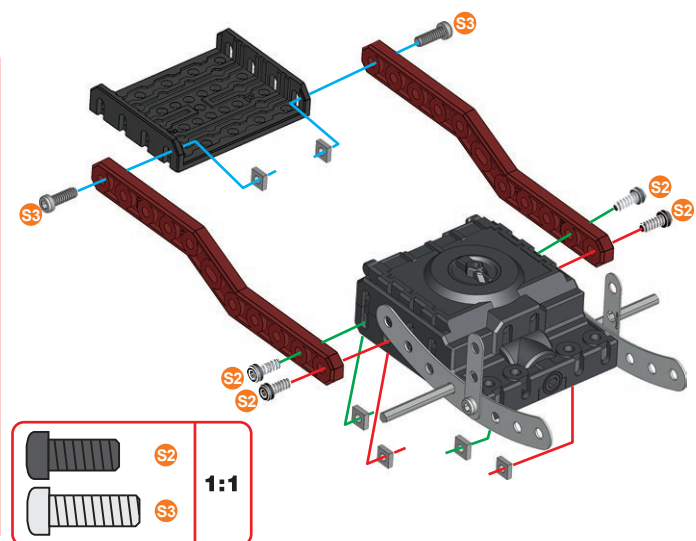

2

-  S2 | 9.5 mm | 3/8" | x4
-  S3 | 12 mm | 1/2" | x2
-  x6
-  x1
-  x2



-  S2 | 1:1
-  S3 | 1:1

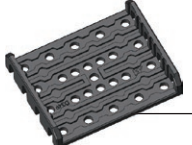

3

-  S3 | 12 mm | 1/2" | x4
-  x4
-  x1

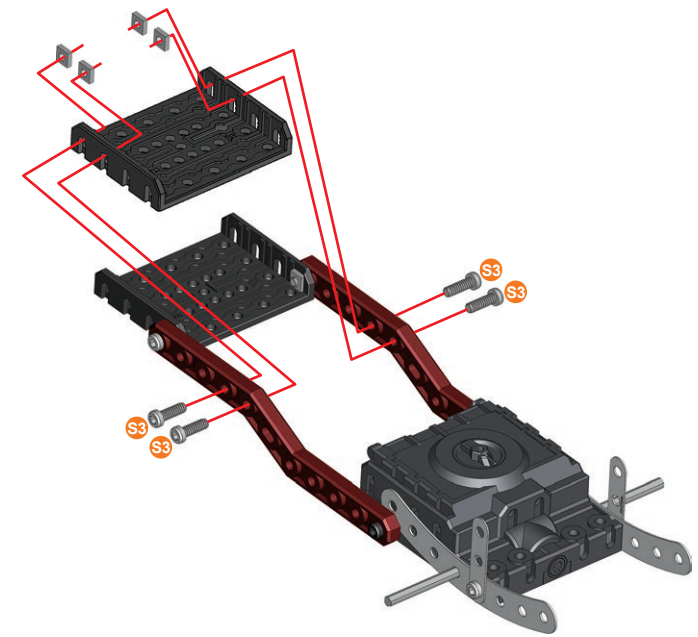
-  S3 | 1:1

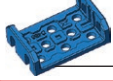

4

-  S3 | 12 mm | $\frac{1}{2}$ " | x2
-  | x2
-  | x2

-  S3 | 1:1

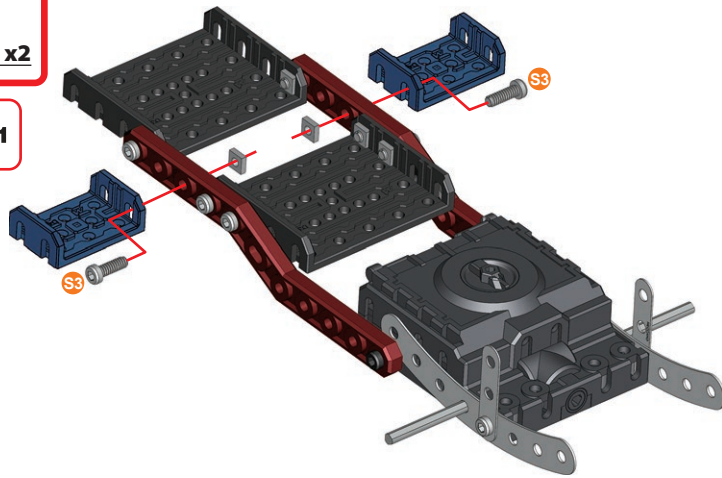





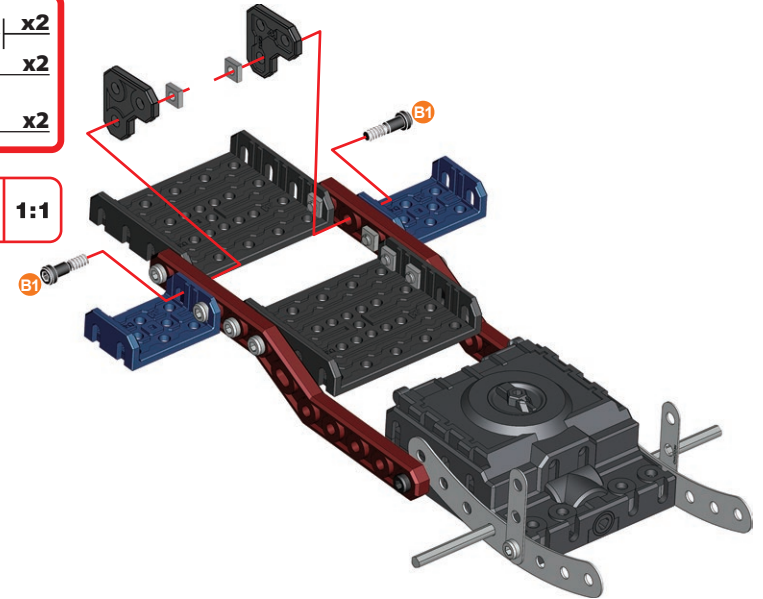

5



-  E1 | 14.7 mm | $\frac{37}{64}$ " | x2
-  | x2
-  | x2

-  E1 | 1:1





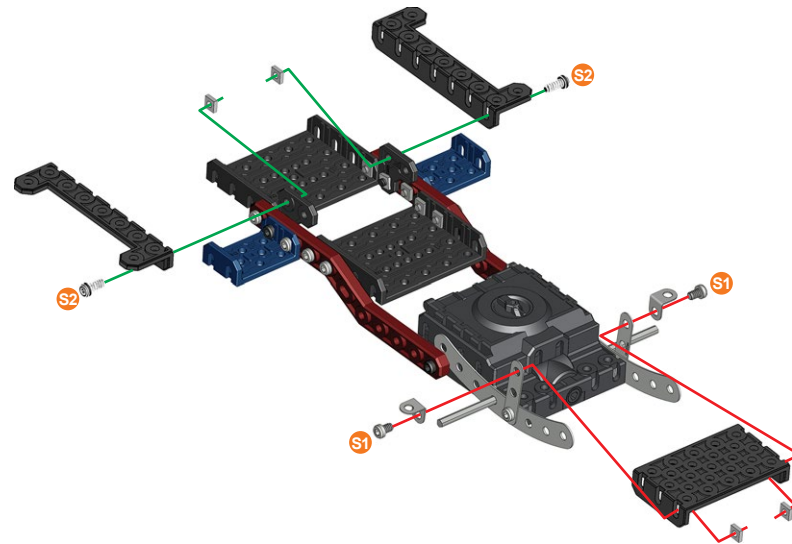

6

-  S1 | 5.8 mm | $\frac{15}{64}$ " | x2
-  S2 | 9.5 mm | $\frac{3}{8}$ " | x2
-  | x4
-  | x2
-  | x1
-  | x2

-  S1 | 1:1
-  S2 | 1:1





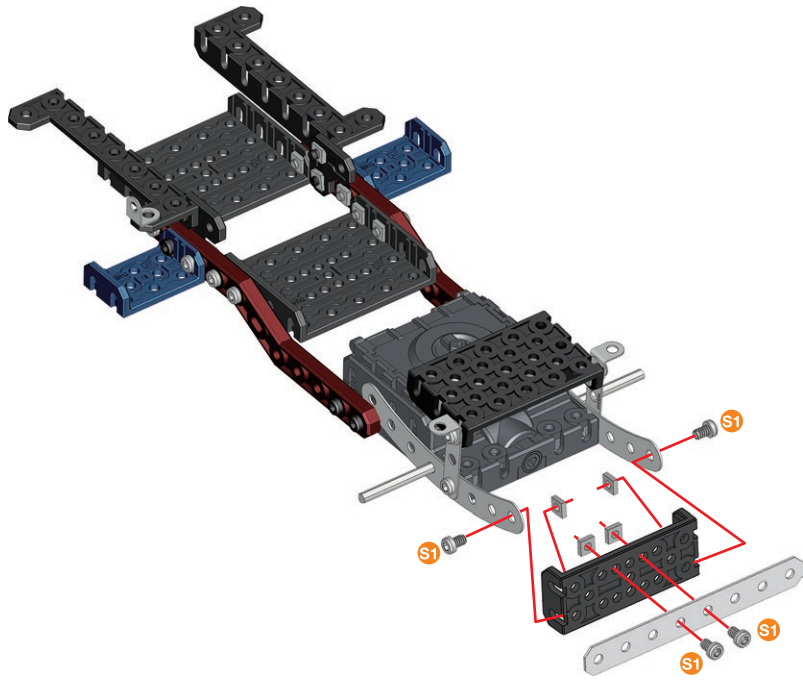

7

	5,8 mm 15/64"	x4
		x4
		x1
		x1



	1:1
---	------------



8





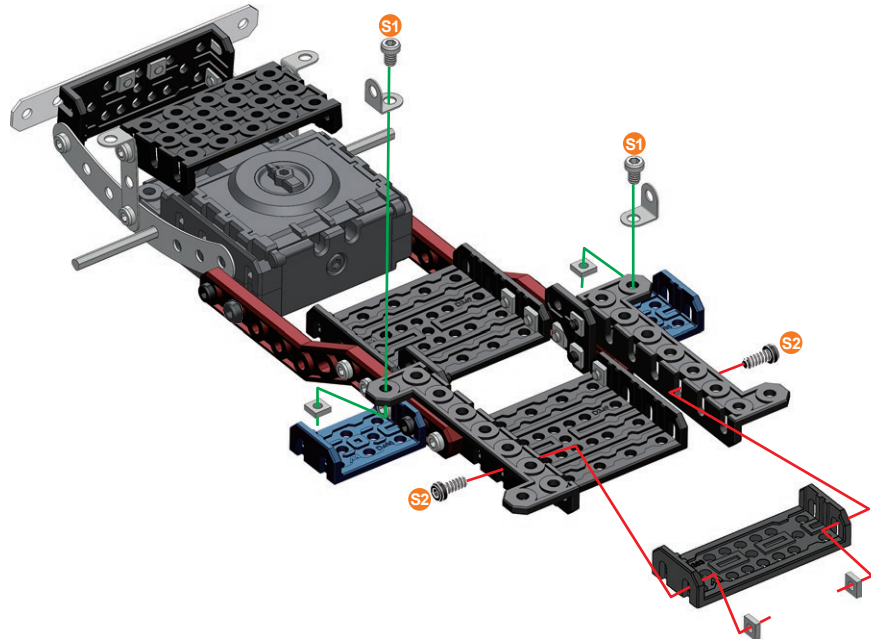

	5,8 mm 15/64"	x2
	9,5 mm 3/8"	x2
		x4
		x2
		x1



	1:1
	



9

-  **S2** | 9.5 mm | **x2**
3/8"
-  **B3** | 23 mm | **x1**
15/16"
-  **x3**
-  **x1**
-  **x2**
-  **x1**

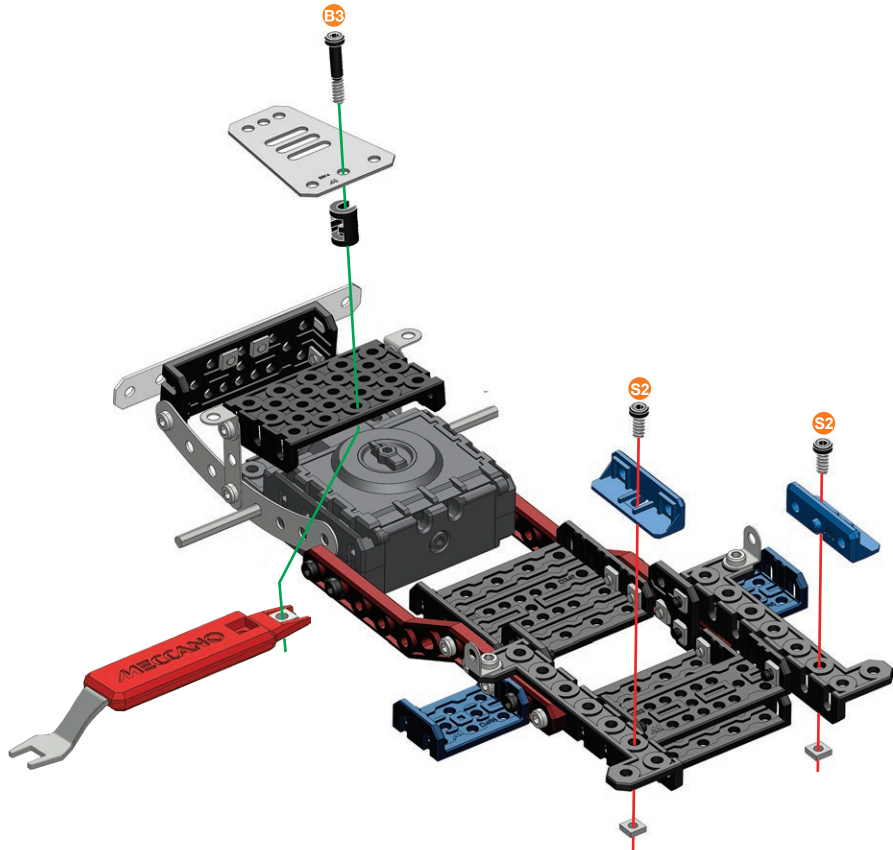
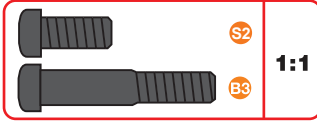



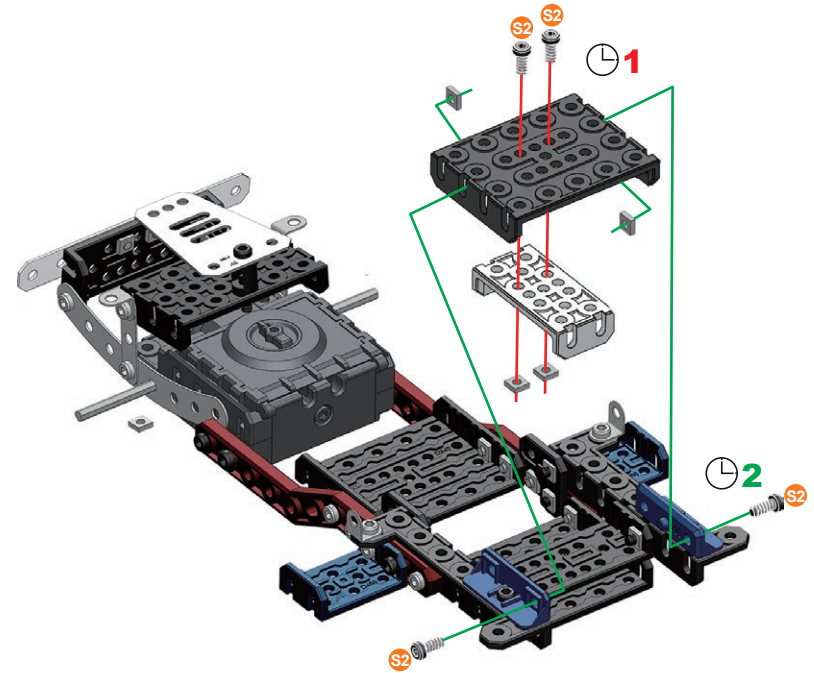

10

-  **S2** | 9.5 mm | **x4**
3/8"
-  **x4**
-  **x1**
-  **x1**





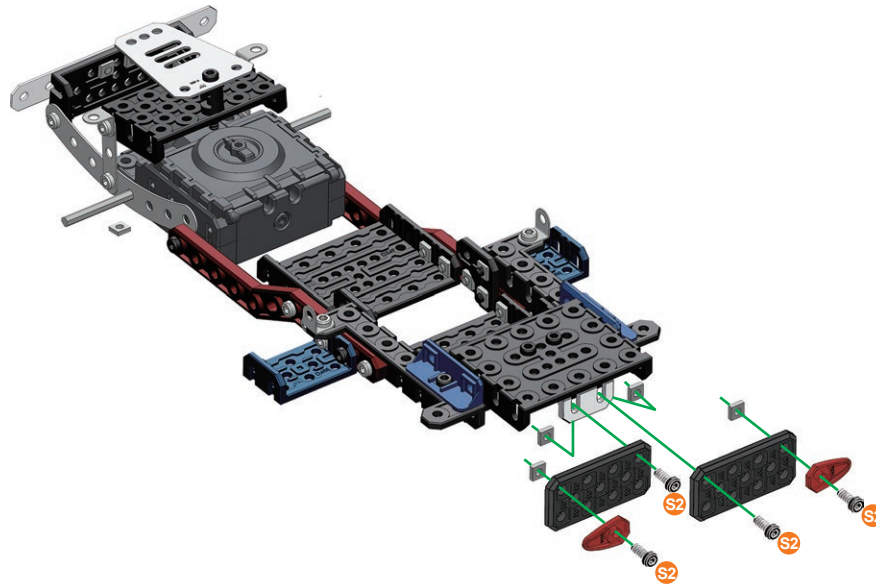

11

	9.5 mm 3/8"	x4
		x4
		x2
		x2

	S2	1:1
---	----	-----



12



	5.8 mm 15/64"	x2
	12 mm 1/2"	x2
		x4
		x2
		x1

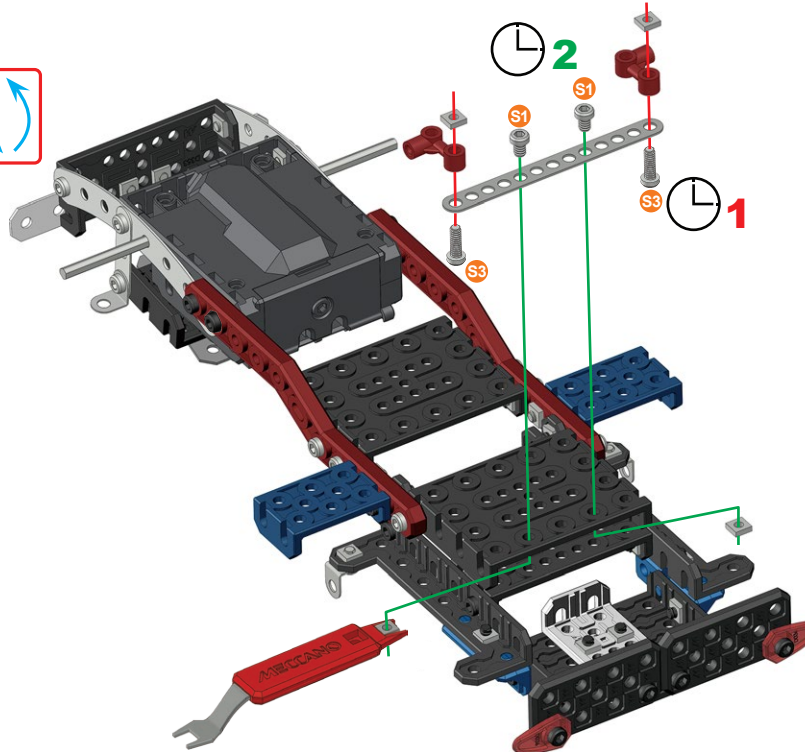

	S1	1:1
	S3	





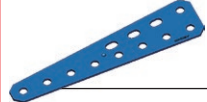

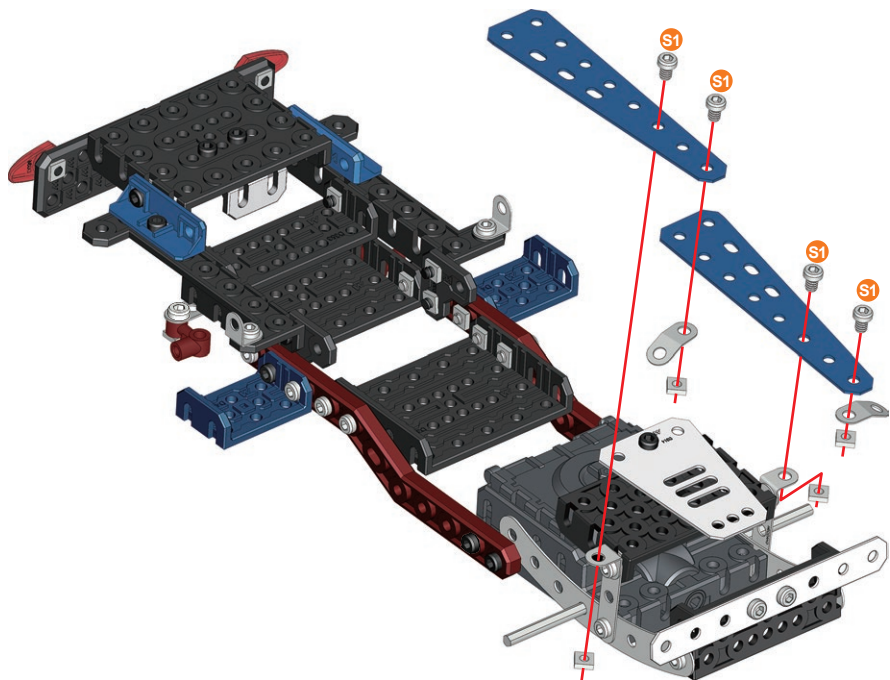



13

-  5.8 mm | 15/64" | **x4**
-  **x4**
-  **x2**
-  **x2**





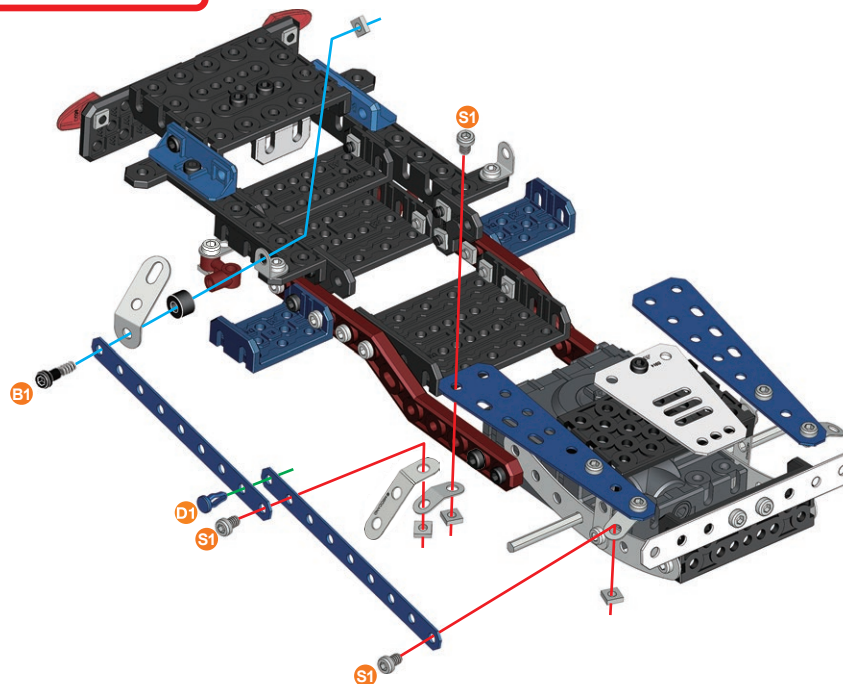
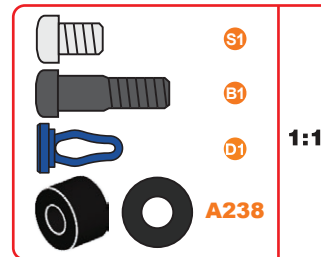

14

-  11.25 mm | 7/16" | **x1**
-  5.8 mm | 15/64" | **x3**
-  14.7 mm | 37/64" | **x1**
-  **x4**
-  **x1**
-  **x1**
-  **x1**
-  **x2**







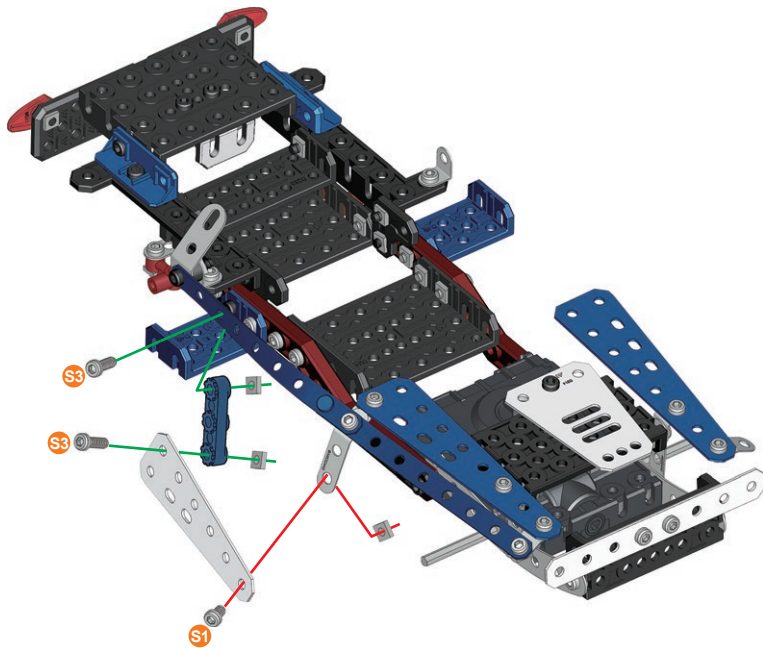
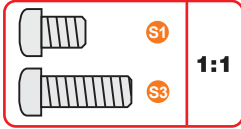

15

-  5.8 mm $\frac{15}{64}$ " x1
-  12 mm $\frac{1}{2}$ " x2
-  x3
-  x1
-  x1





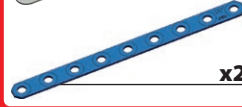

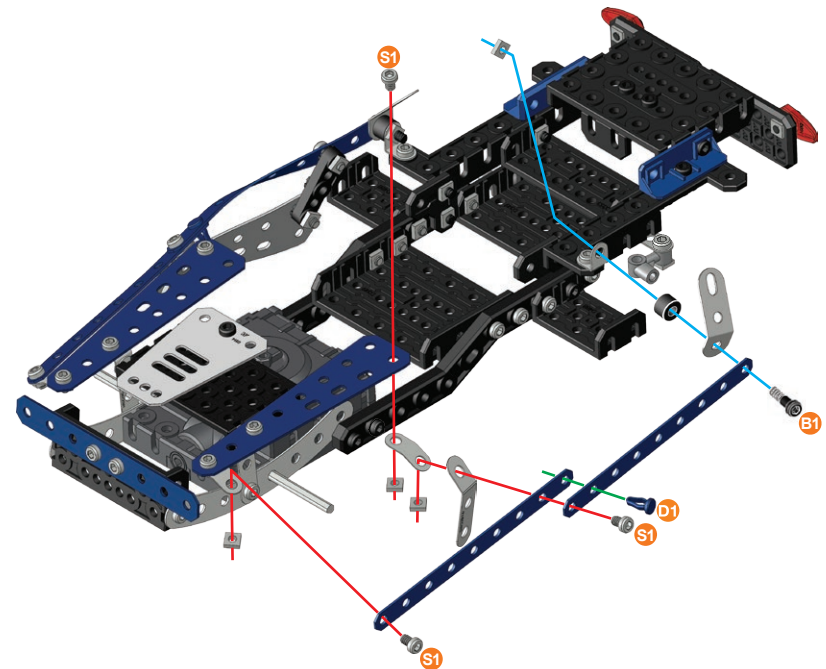
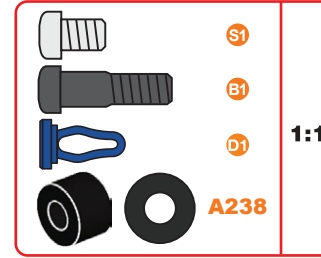

16

-  11.25mm $\frac{7}{16}$ " x1
-  5.8 mm $\frac{15}{64}$ " x3
-  14.7 mm $\frac{37}{64}$ " x1
-  x4
-  x1
-  x1
-  x1
-  x2

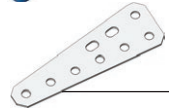

17

-  S1 | 5.8 mm | x1
-  S3 | 12 mm | x2
-  | x3
-  | x1
-  | x1

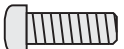
-  S1
 -  S3
- 1:1**

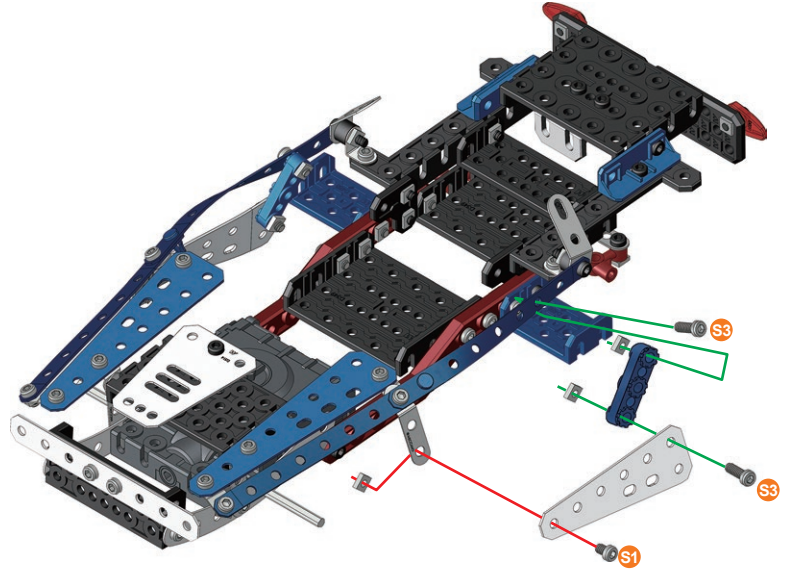





18

-  | x4
-  | x4



19

(17)+(18)+

-  B3 | 23 mm | x1
-  | x1
-  | x1
-  | x1
-  | x1

-  B3
 -  A238
- 1:1**

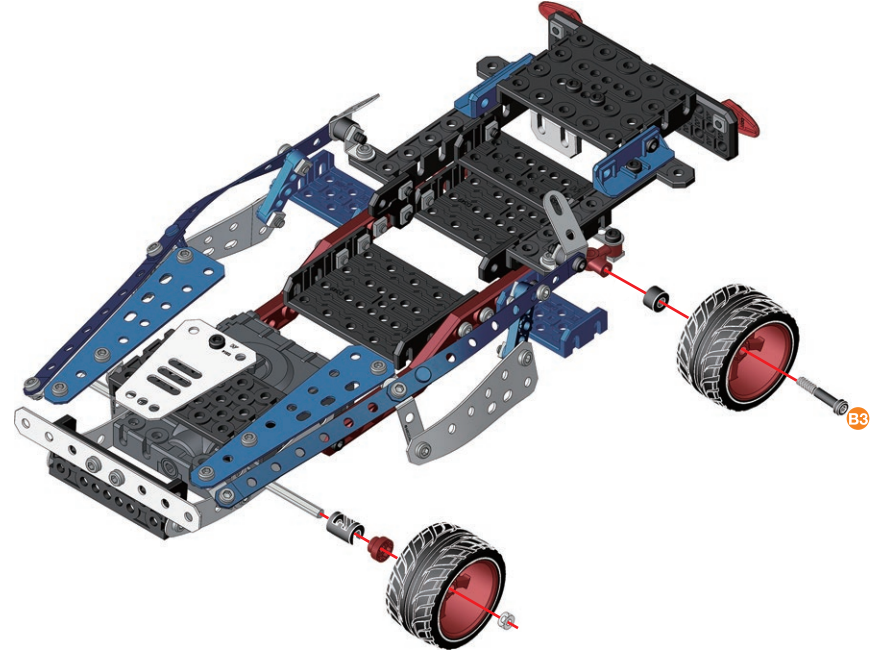

20 (18)+(19)+

	23 mm 1 5/16"	x1
		x1
		x1
		x1
		x1

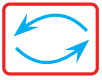

	B3	1:1
	A238	

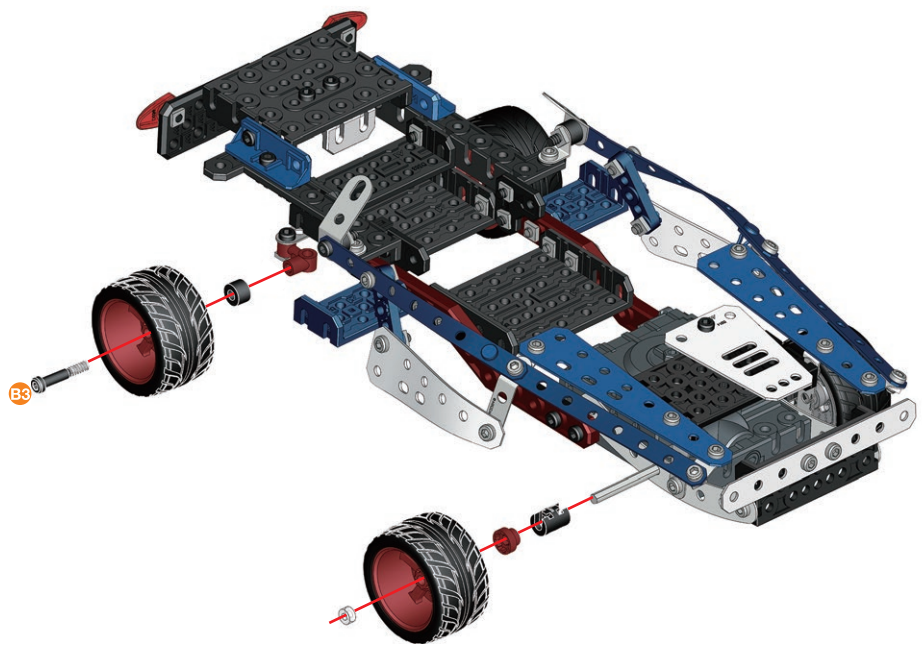

21

	5.8 mm 15/64"	x2
	9.5 mm 3/8"	x2
		x4
		x2
		x2
		x1
		x2
		x2

	S1	1:1
	S2	

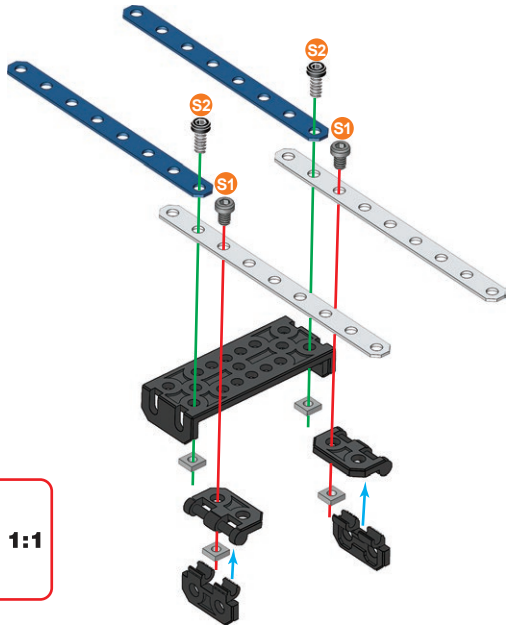



22

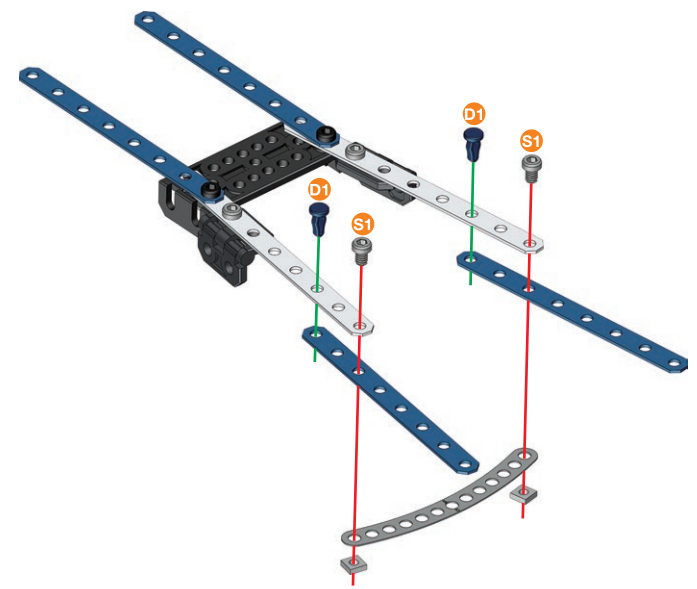

	11.25 mm 7/16"	x2
	5.8 mm 15/64"	x2
		x2
		x1
		x2

	S1	1:1
	D1	





23**①+②+**

	S1	5,8 mm 15/64"	x2
	S2	9,5 mm 3/8"	x2
			x4

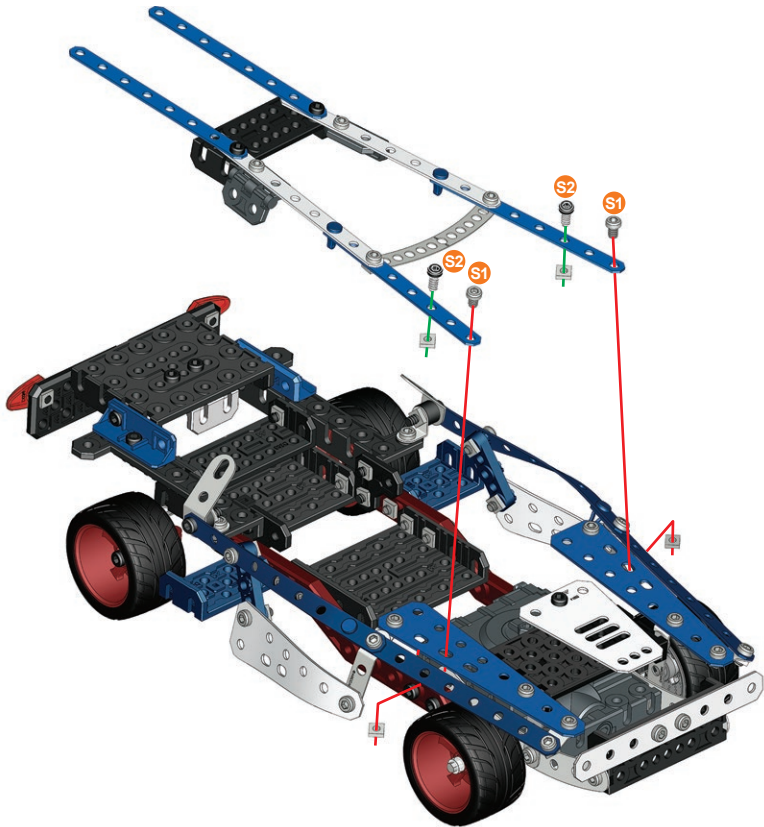
	S1	1:1
	S2	



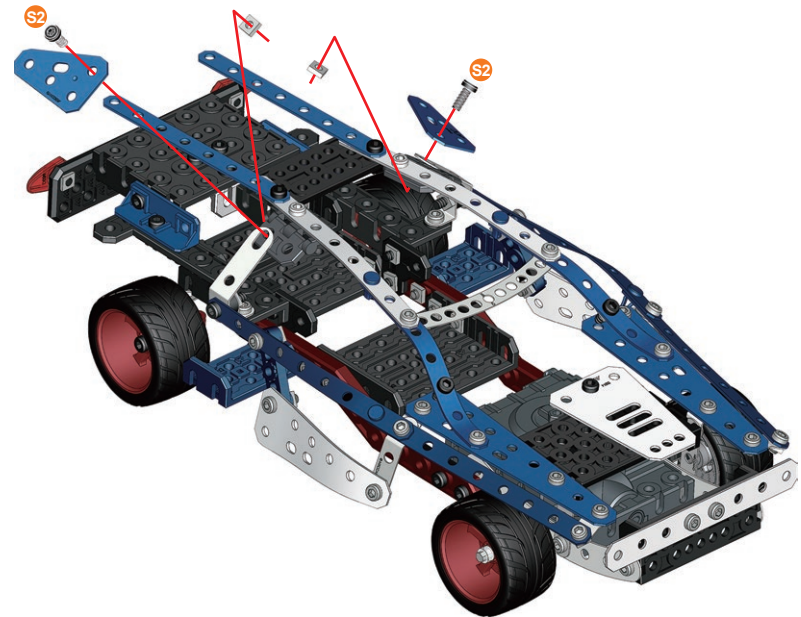

**24**

	S2	9,5 mm 3/8"	x2
			x2
			x2

	S2	1:1
--	----	-----







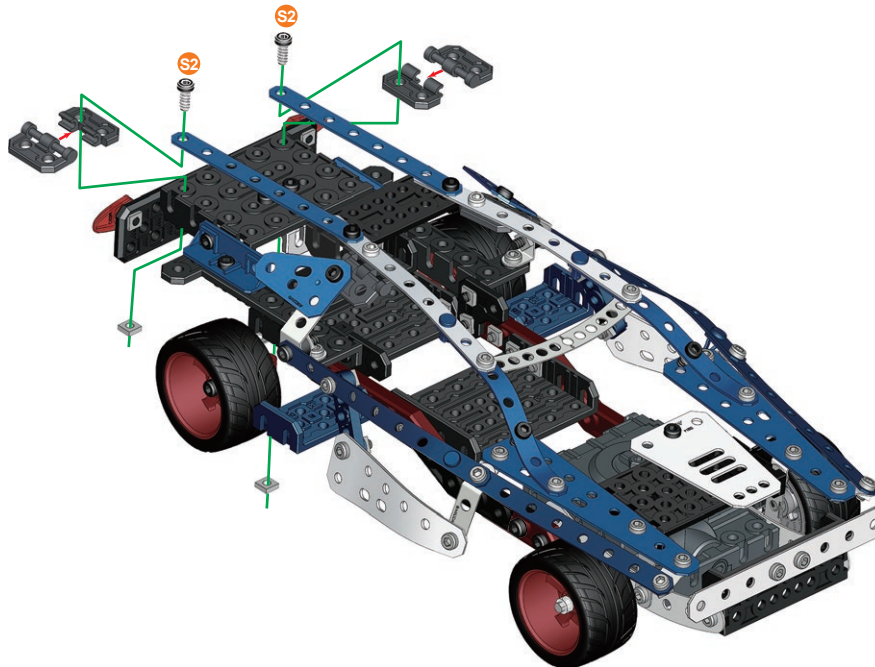

25



	S2 9.5 mm x2 3/8"
	x2
	x2
	x2

	S2 1:1
---	----------







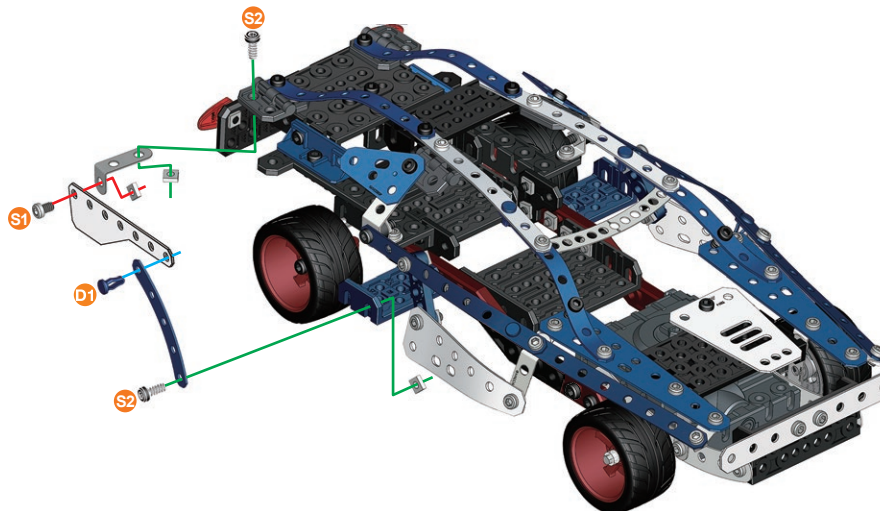

26



	D1 11.25mm x1 7/16"
	S1 5.8 mm x1 15/64"
	S2 9.5 mm x2 3/8"
	x3
	x1
	x1
	x1

	S1	1:1
	S2	
	D1	



27

-  **D1** | 11.25mm
7/16" | **x1**
-  **S1** | 5.8 mm
15/64" | **x1**
-  **S2** | 9.5 mm
3/8" | **x2**
-  | **x3**
-  | **x1**
-  | **x1**
-  | **x1**

-  **S1**
-  **S2**
- 1:1**
-  **D1**

