







1

-  x1
-  x1

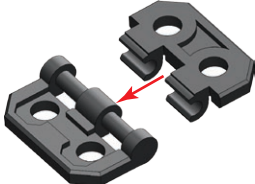





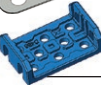

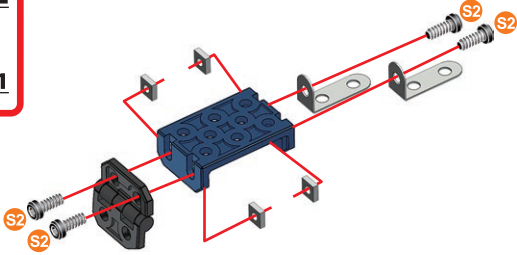

2

-  9.5 mm | 3/8" | x4
-  x4
-  x2
-  x1

 1:1





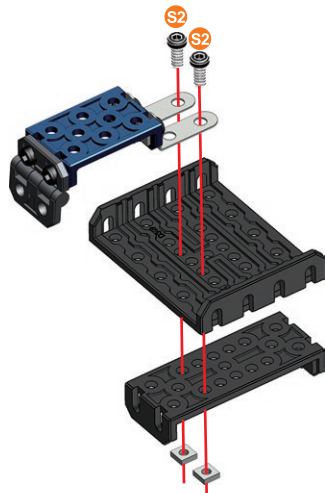

3

-  9.5 mm | 3/8" | x2
-  x2
-  x1
-  x1
-  1:1





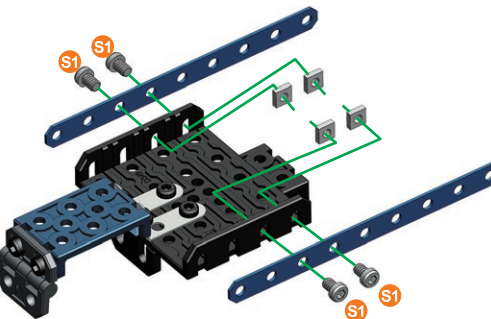

4

-  5.8 mm | 15/64" | x4
-  x4
-  x2
-  1:1

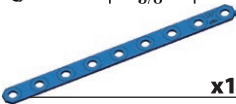
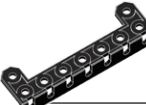
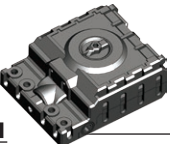

5

-  9.5 mm | 3/8" | x2
-  x2
-  x1
-  x1
-  x1
-  1:1



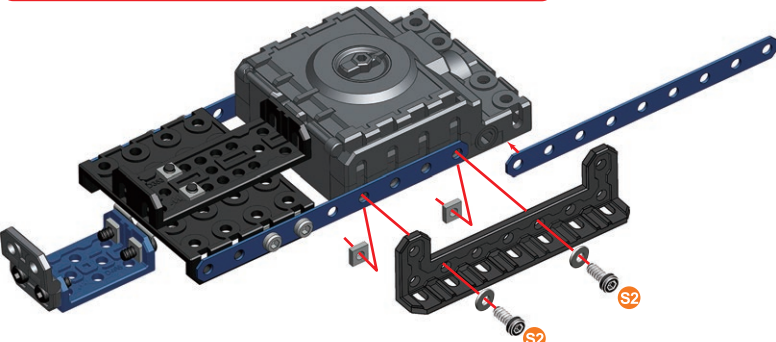

6

- 9.5 mm | 3/8" | x2
- x2
- x2
- x1
- x1

1:1

7

- 9.5 mm | 3/8" | x2
- x2
- x2

1:1

8

- 40 mm | 1 9/16" | x1
- x1
- x1
- x1



1:1

9

- 133.4 mm | 5 1/4" | x1
- x1

1:1



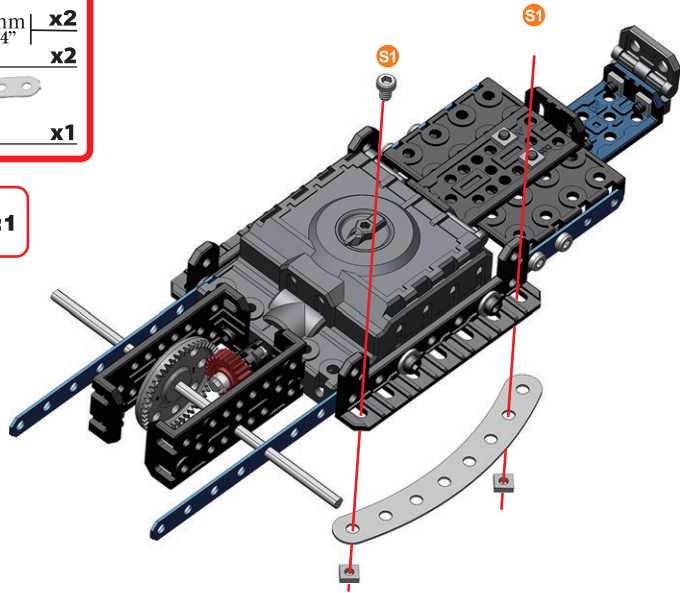

10

-  **S1** | 5.8 mm | 15/64" | **x2**
-  **x2**
-  **x1**

-  **S1** | **1:1**





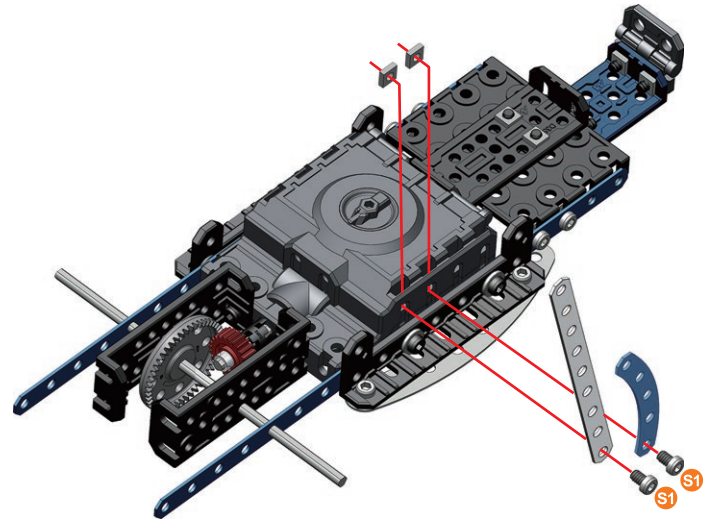

11

-  **S1** | 5.8 mm | 15/64" | **x2**
-  **x2**
-  **x1**
-  **x1**

-  **S1** | **1:1**



12



-  **S1** | 5.8 mm | 15/64" | **x3**
-  **x3**
-  **x1**
-  **x1**

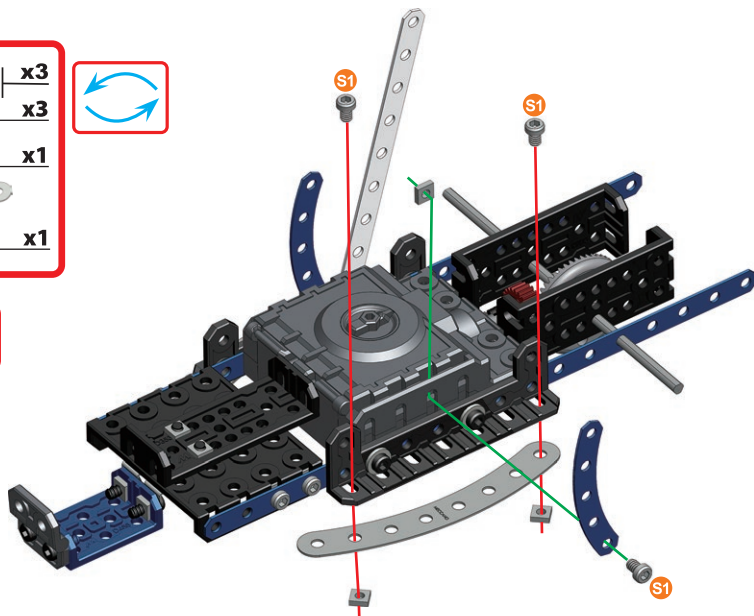

-  **S1** | **1:1**



13

-  **S1** | 5.8 mm | 15/64" | **x1**
-  **x1**

-  **S1** | **1:1**

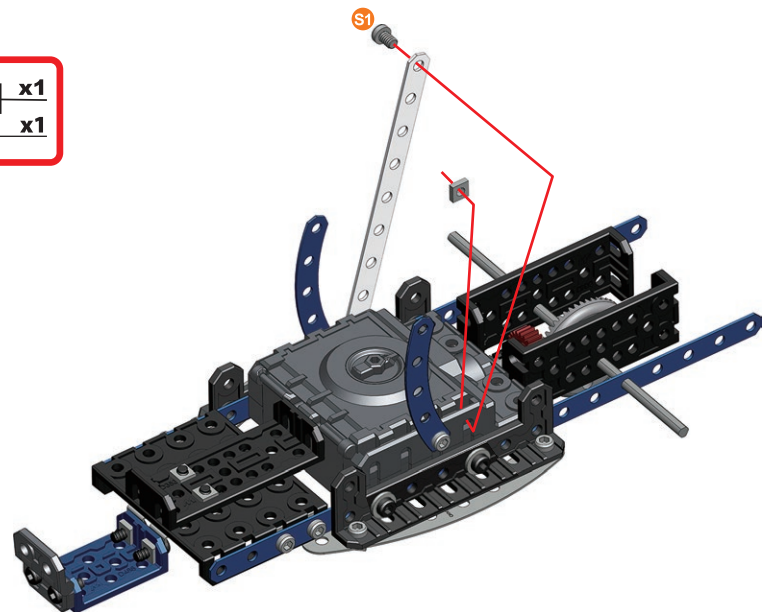

14

D1 | 11.25mm | **x2**
7/16"
x1

D1 | **1:1** 

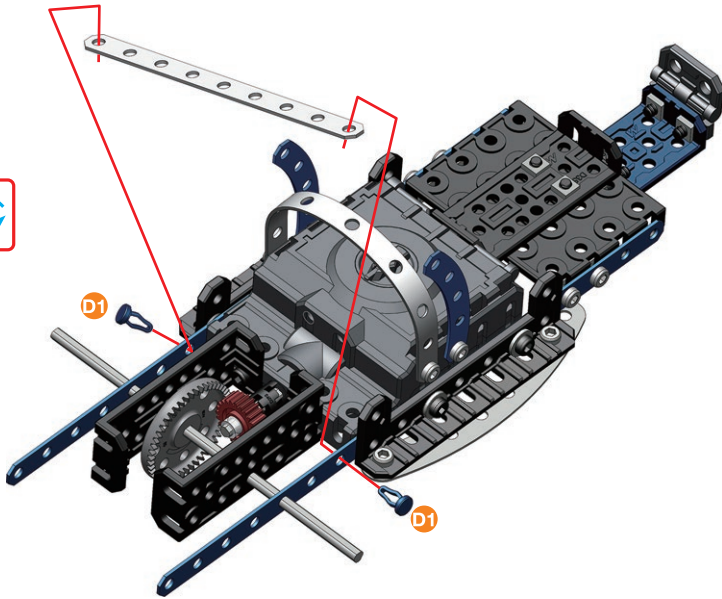

15

S1 | 5.8 mm | **x2**
15/64"
x2
x2
x1

S1 | **1:1**

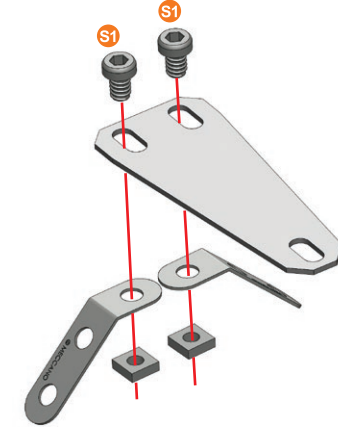

16

S1 | 5.8 mm | **x4**
15/64"
x4
x1
x2

S1 | **1:1**

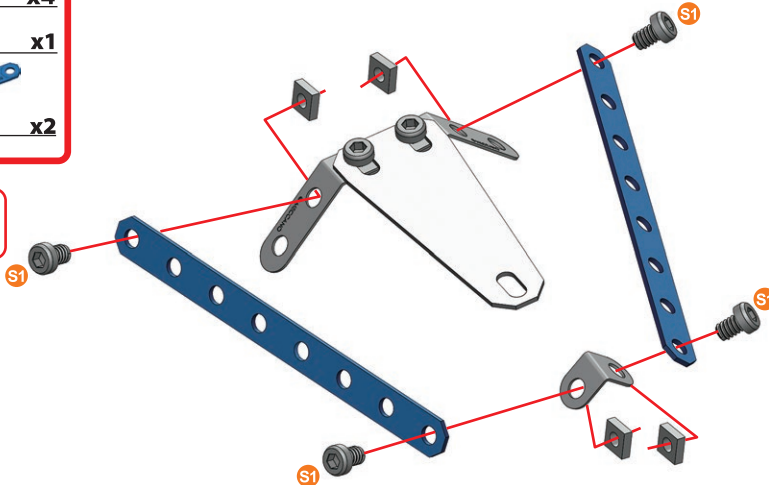

17







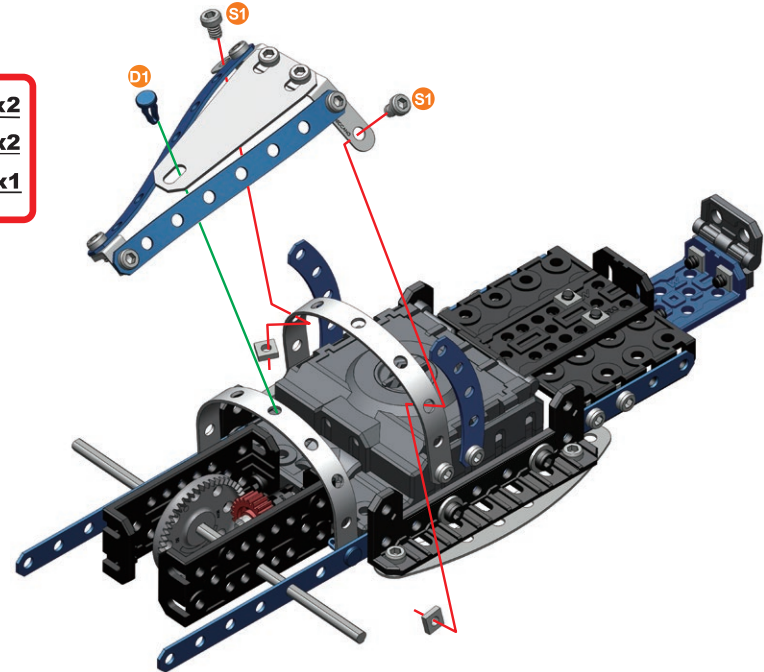

(14)+(16)+

S1 | 5.8 mm | **x2**
15/64"
x2
D1 | 11.25mm | **x1**
7/16"

S1 | **1:1**
D1









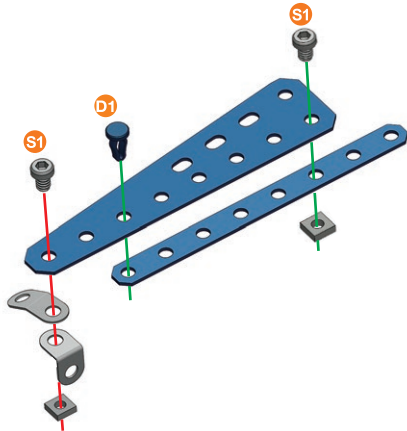

18



-  | 5,8 mm | x2
-  | x2
-  | 11,25 mm | x1
-  | x1
-  | x1
-  | x1
-  | x1
-  | x1

-  | 1:1
-  | 1:1



19

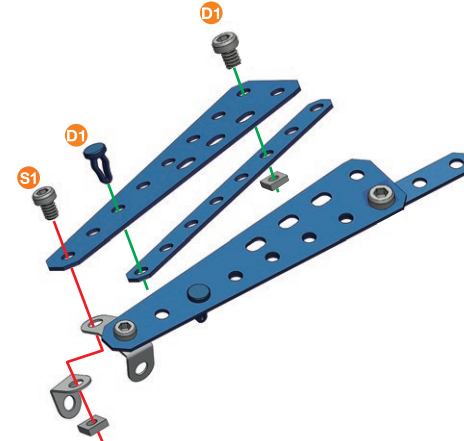

-  | 5,8 mm | x2
-  | x2
-  | 11,25 mm | x1
-  | x1
-  | x1
-  | x1
-  | x1
-  | x1

-  | 1:1
-  | 1:1



20





17+19+

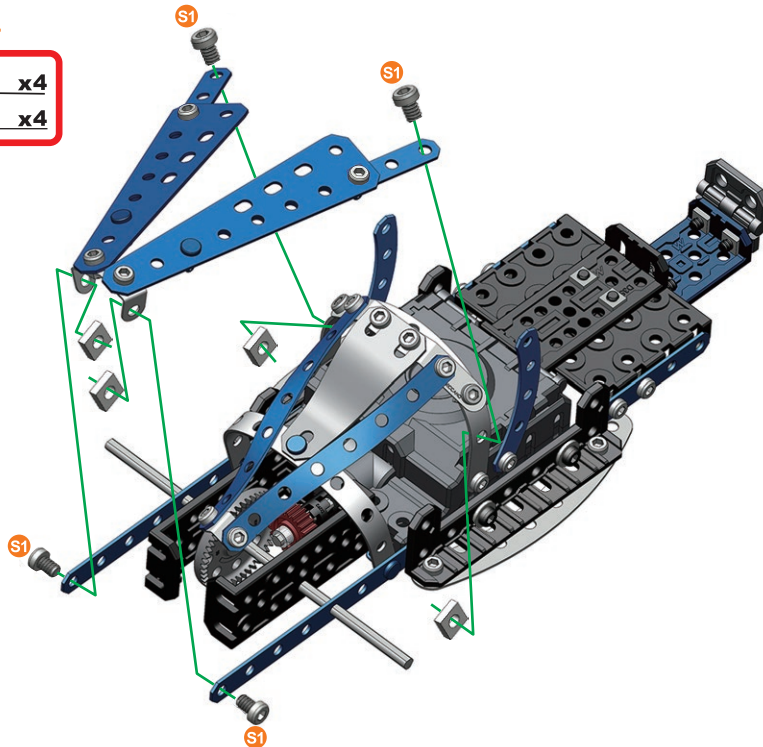

-  | 5,8 mm | x4
-  | x4

-  | 1:1



21

-  | 9,5 mm | x2
-  | x2
-  | 11,25 mm | x2
-  | x2

-  | 1:1
-  | 1:1

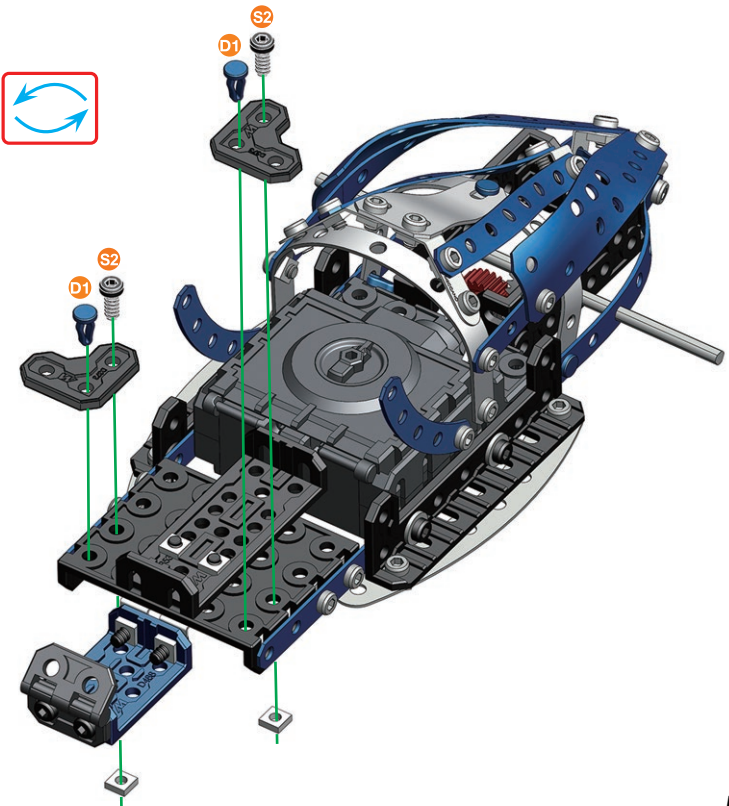

22

- S3 | 12 mm | x2
1/2"
- B1 | 14.7 mm | x2
37/64"
- x4
- x2
- x1

- S3 | 1:1
- B1 | 1:1

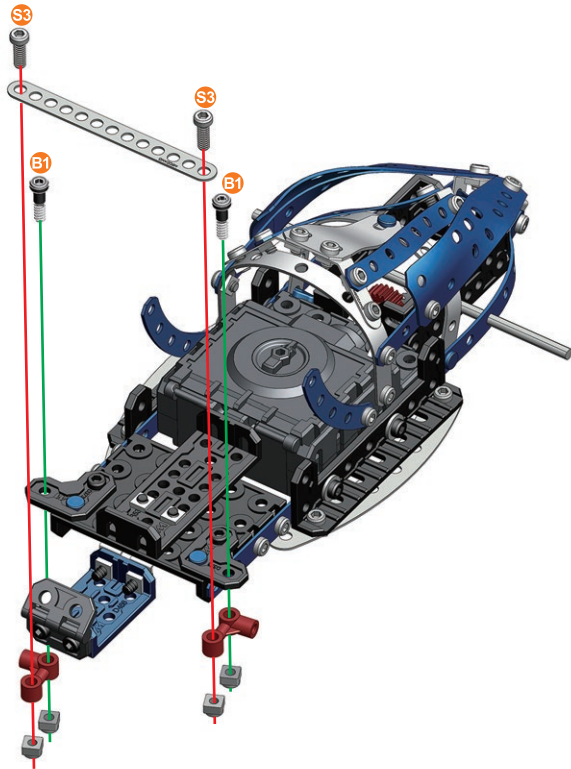

23

- S1 | 5.8 mm | x2
15/64"
- x2

- S1 | 1:1

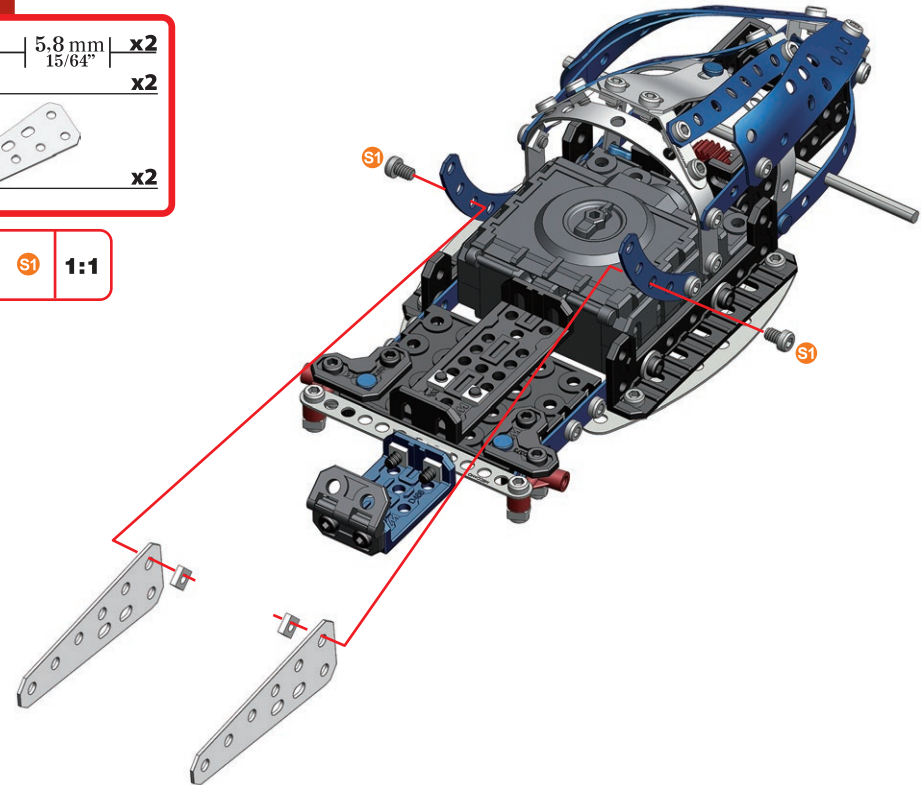

24

- S2 | 9.5 mm | x3
3/8"
- x3
- x1
- x1
- x1
- x1

- S2 | 1:1

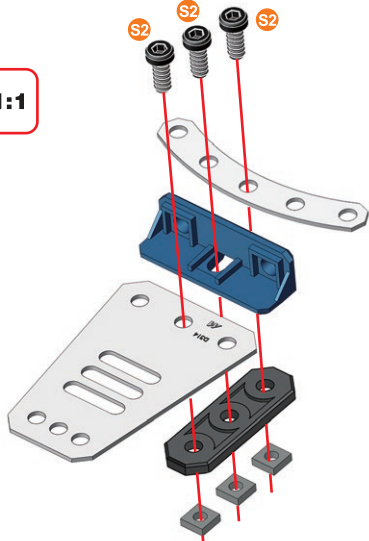





25

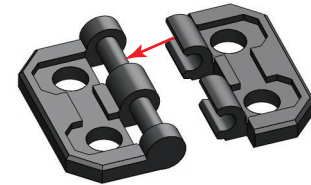



- x2
- x2

- x2

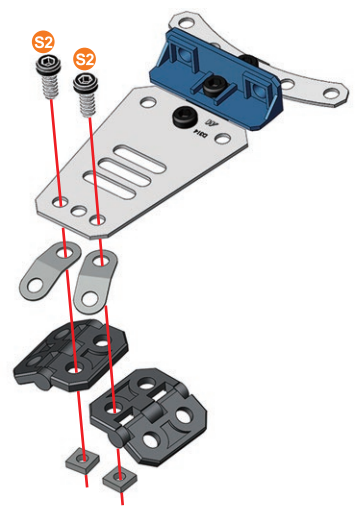





- 26** 24+25+
- | | | |
|---|----------------|----|
|  | 9,5 mm 3/8" | x2 |
|  | | x2 |
|  | | x2 |
- | | | |
|---|--|-----|
|  | | 1:1 |
|---|--|-----|

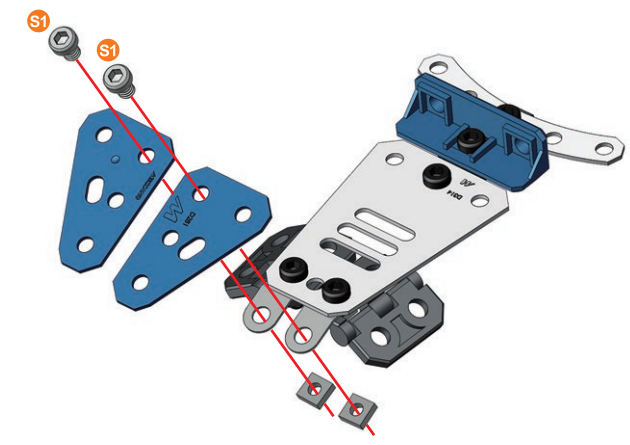



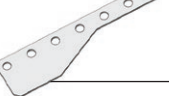

- 27**
- | | | |
|---|------------------|----|
|  | 5,8 mm 15/64" | x2 |
|  | | x2 |
|  | | x2 |
- | | | |
|---|--|-----|
|  | | 1:1 |
|---|--|-----|

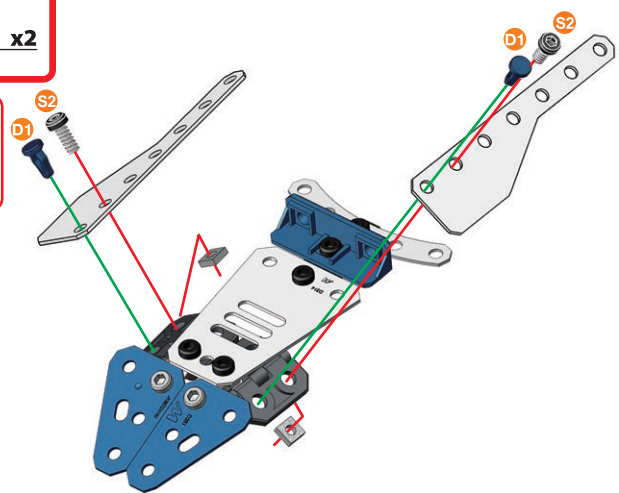

- 28**
- | | | |
|--|------------------|----|
|  | 9,5 mm 3/8" | x2 |
|  | | x2 |
|  | 11,25mm 7/16" | x2 |
|  | | x2 |
- | | | |
|---|--|-----|
|  | | 1:1 |
|  | | 1:1 |



- 29** 23+28+
- | | | |
|---|----------------|----|
|  | 9,5 mm 3/8" | x2 |
|  | | x2 |
|  | | x2 |
- | | | |
|---|--|-----|
|  | | 1:1 |
|---|--|-----|

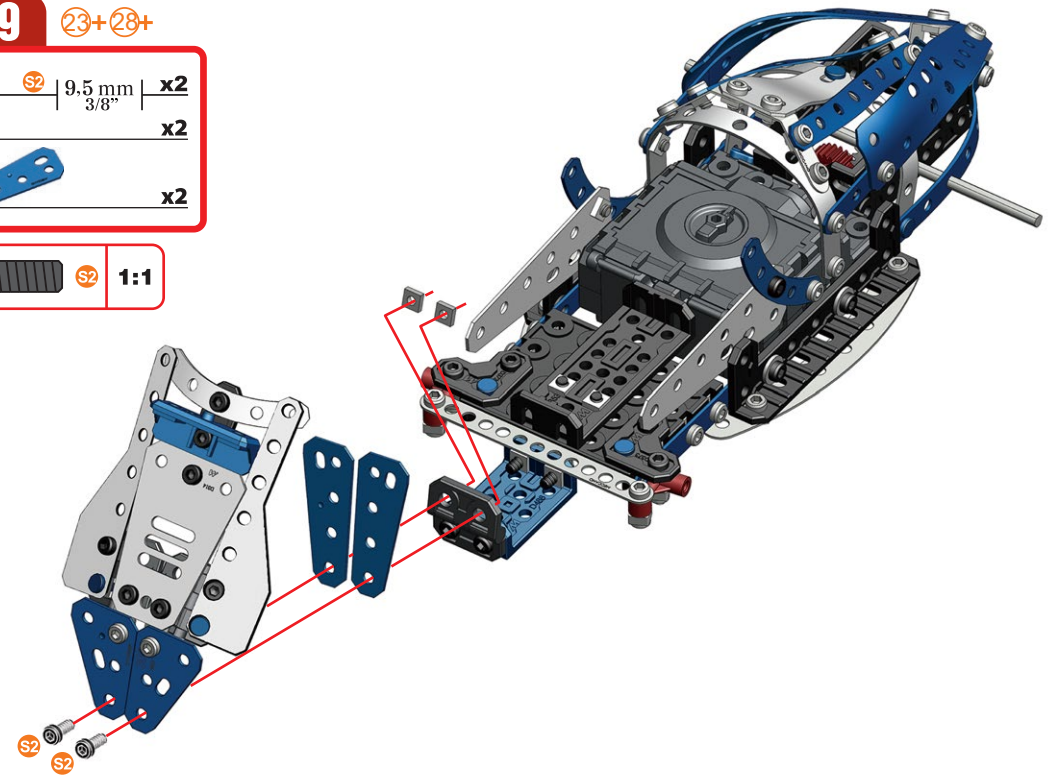

30

S2 | 9,5 mm | x1
3/8" | x1

S2 | 1:1

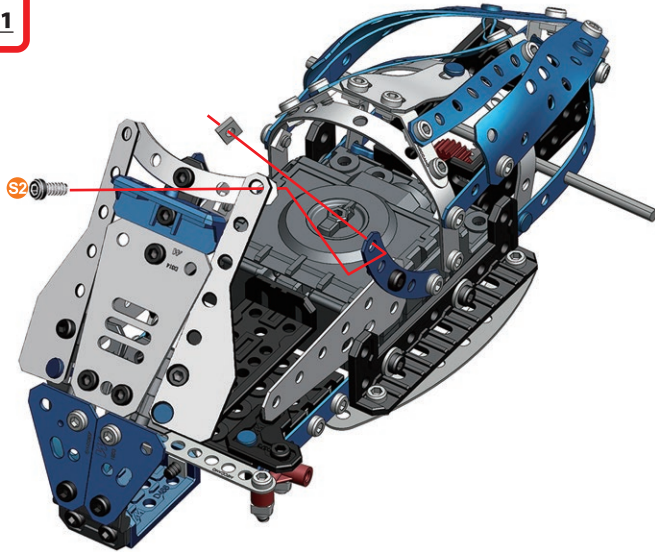

31

S2 | 9,5 mm | x1
3/8" | x1

D1 | 11,25mm | x1
7/16" | x1

S2 | 1:1
D1

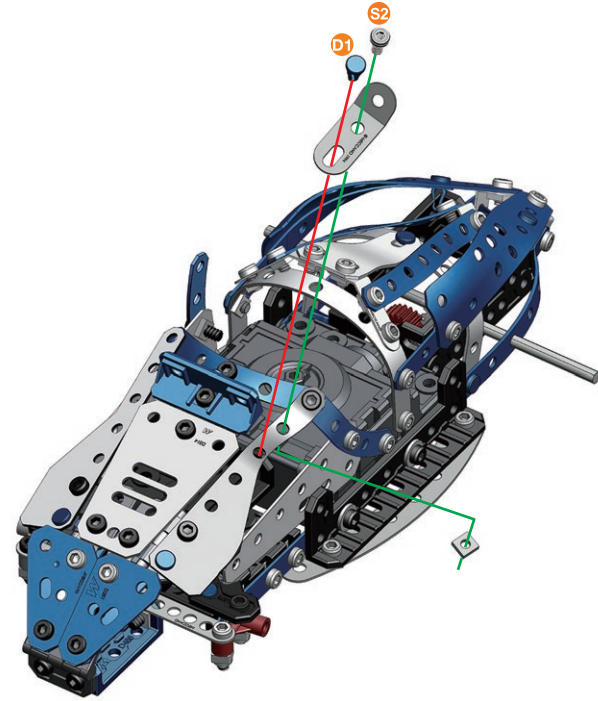

32

S2 | 9,5 mm | x1
3/8" | x1



S2 | 1:1

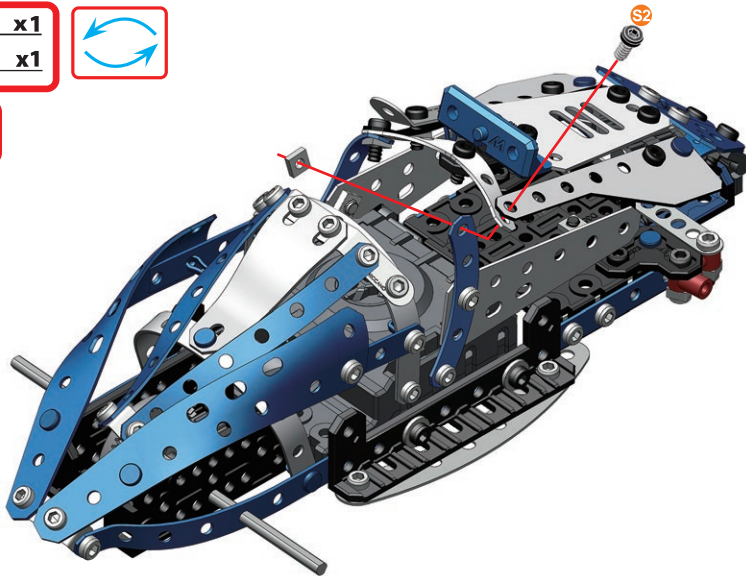

33

S2 | 9,5 mm | x1
3/8" | x1

D1 | 11,25mm | x1
7/16" | x1

S2 | 1:1
D1

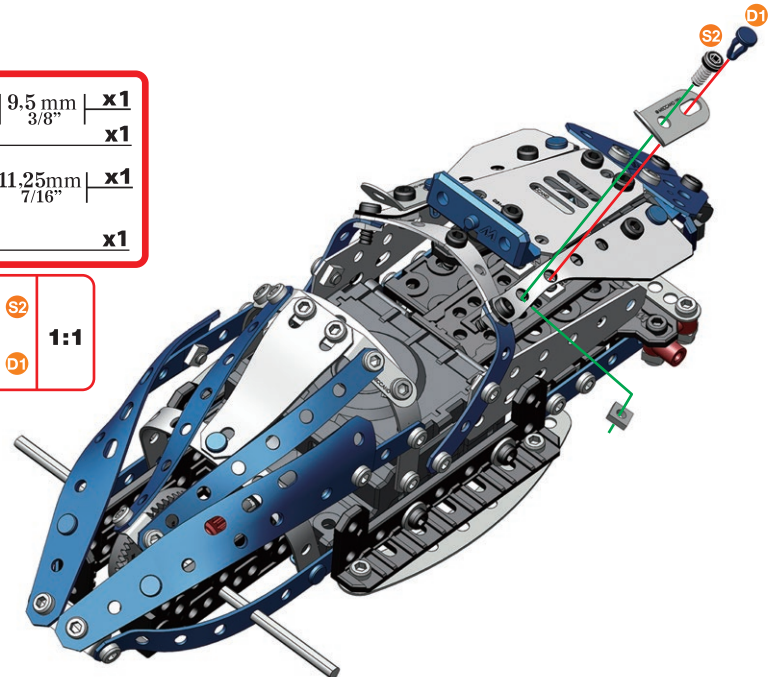



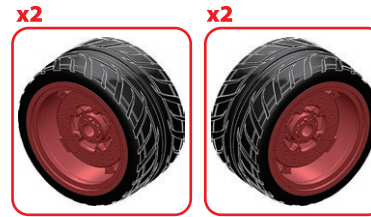
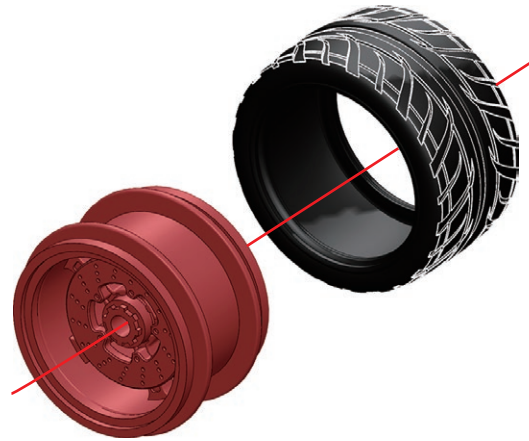

34

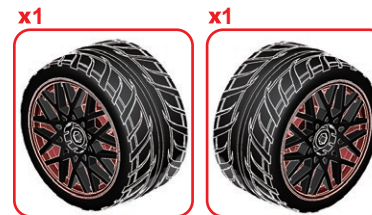
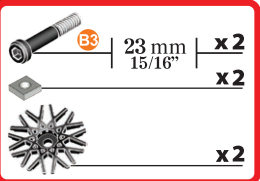

35



36 33+34+

| | |
|--|----|
|  | x4 |
|  | x2 |
|  | x2 |
|  | x2 |

| | | | |
|--|---|------|-----|
|  |  | A238 | 1:1 |
|--|---|------|-----|

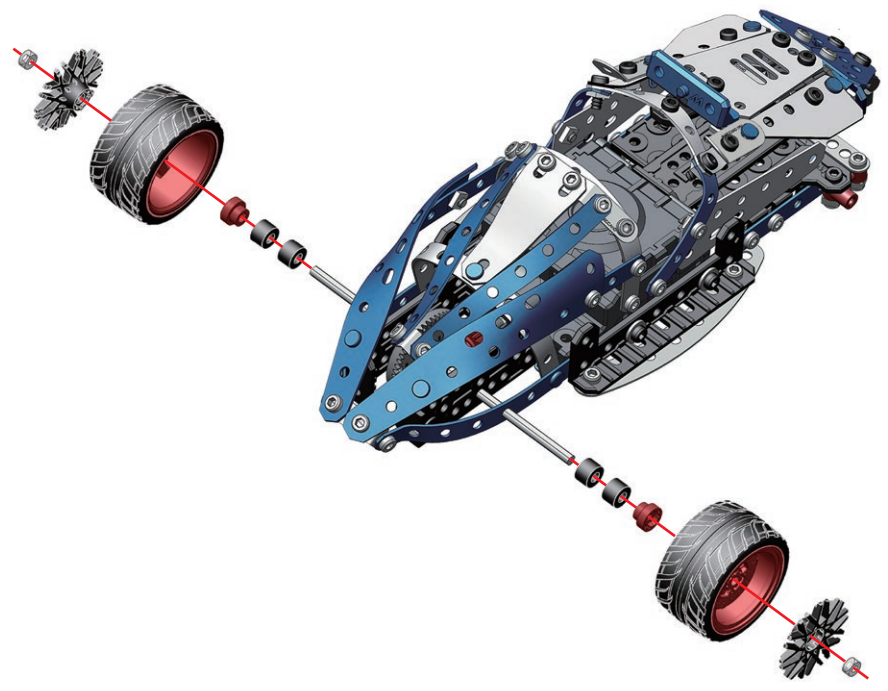

37 35+36+

