

30

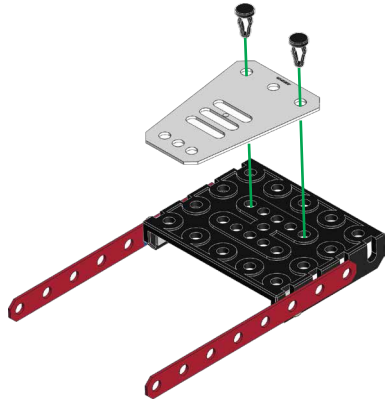

31

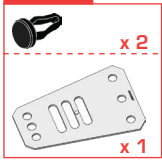
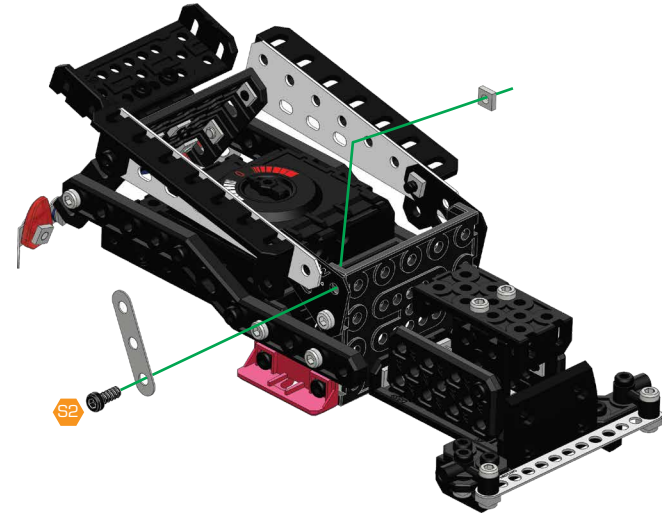
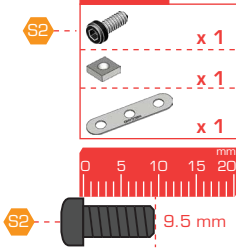

32

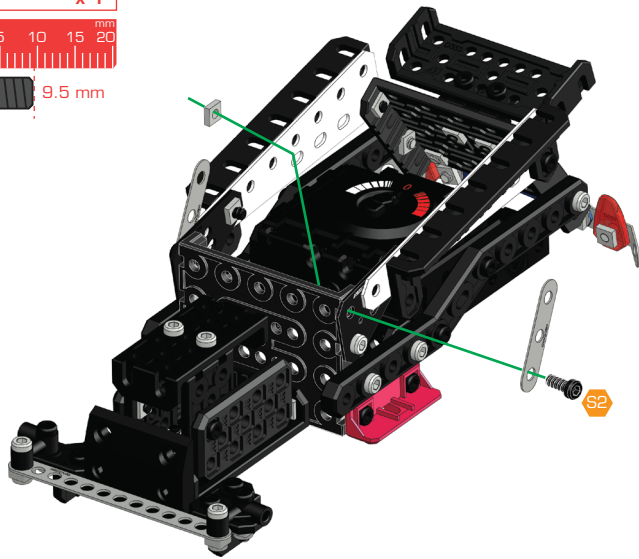
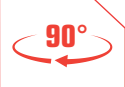
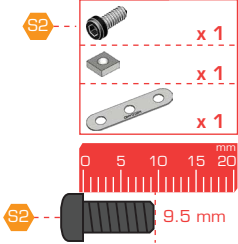

33 30+32

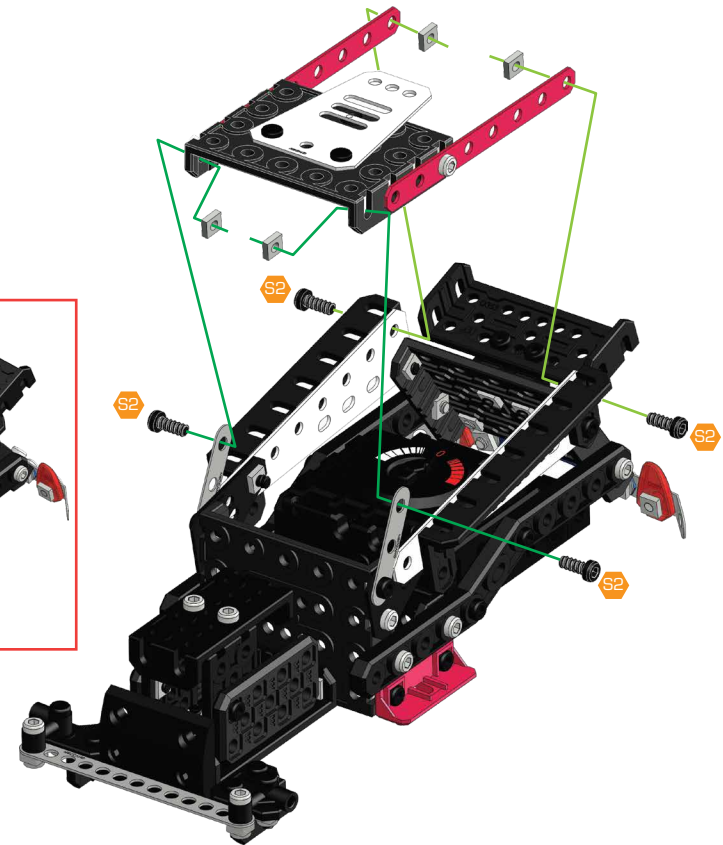
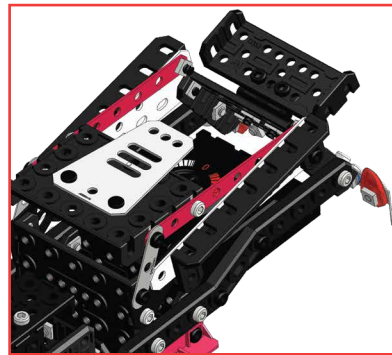
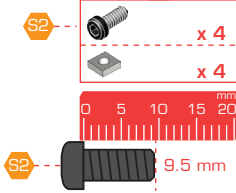

34

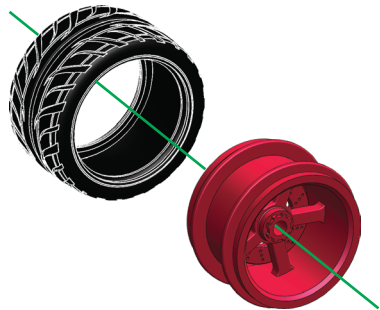
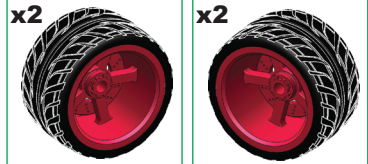



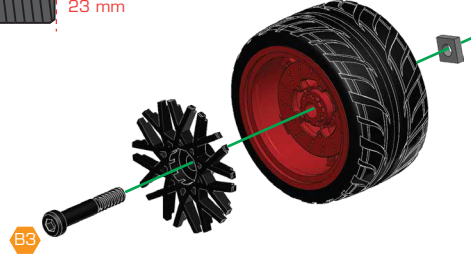
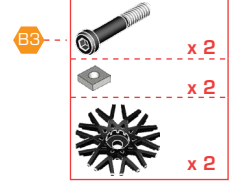

35

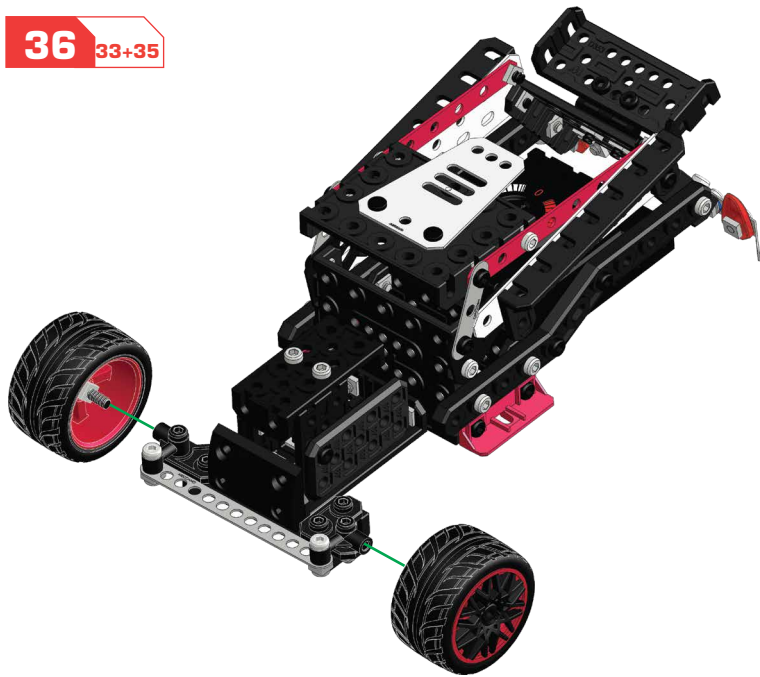

36 33+35



37 34+36

-  x 1
-  x 2
-  x 2
-  x 2
-  x 2

