

- EN** Start Here
- FR** Démarrez ici
- DE** Hier starten
- NL** Hier beginnen

 Warnings must be followed carefully to avoid bodily injury.
Avertissement à suivre à la lettre pour éviter des blessures corporelles.
Warnungen sind genau einzuhalten, sonst droht Verletzungsgefahr.
Waarschuwingen moet u zorgvuldig opvolgen om letsel te voorkomen.

Maschinenlärmformations-Verordnung 3. GPSGV: Der höchste Schalldruckpegel beträgt 70 dB(A) oder weniger gemäß EN ISO 7779.
Das Gerät ist nicht für die Benutzung im unmittelbaren Gesichtsfeld am Bildschirmarbeitsplatz vorgesehen. Um störende Reflexionen am Bildschirmarbeitsplatz zu vermeiden, darf dieses Produkt nicht im unmittelbaren Gesichtsfeld platziert werden.
EEE Yönetmeliğine Uygundur.
Информация об изготовителе
Seiko Epson Corporation (Япония)
Юридический адрес: 4-1, Ниси-Синзюку, 2-Чоме, Синзюку-ку, Токио, Япония
Срок службы: 3 года

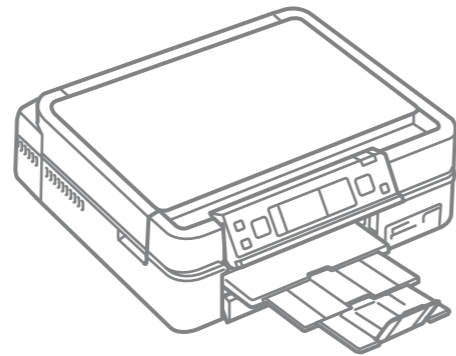

Copyright © 2010 Seiko Epson Corporation. All rights reserved.
Printed in XXXXXX

Unpacking
Déballage
Auspacken
Uitpakken

1

Contents may vary by location.
Le contenu peut varier d'un pays à l'autre.
Inhalt kann je nach Auslieferungsort variieren.
Inhoud kan per land verschillen.

Do not open the ink cartridge package until you are ready to install it in the printer. The cartridge is vacuum packed to maintain its reliability.
N'ouvrez pas l'emballage contenant la cartouche tant que vous n'êtes pas prêt à l'installer dans l'imprimante. La cartouche est conditionnée sous vide afin de garantir sa qualité.
Öffnen Sie die Tintenpatronenpackung erst, wenn die Tintenpatrone im Drucker installiert werden kann. Um eine gleichbleibende Zuverlässigkeit zu gewährleisten, ist die Tintenpatrone vakuumverpackt.
Open de verpakking van de cartridge pas op het moment waarop u de cartridge wilt installeren. De cartridge is vacuümverpakt om de betrouwbaarheid te waarborgen.

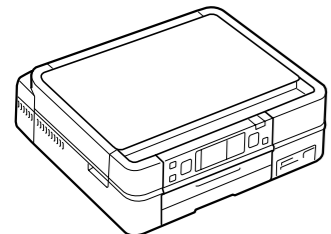

Remove all protective materials.
Retirez tous les matériaux de protection.
Alle Schutzmaterialien entfernen.
Beschermmateriaal verwijderen.

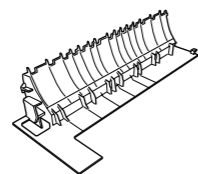
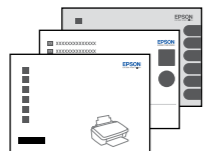
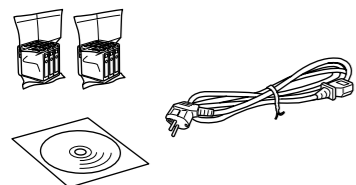

Optional item: see "Using the optional rear cover" in the *Basic Operation Guide*.

Élément optionnel : reportez-vous à la section « Utilisation du capot arrière en option » dans le *Guide des opérations de base*.

Optionales Zubehör: siehe „Verwenden der optionalen hinteren Abdeckung“ im *Benutzerhandbuch - Grundlagen*.

Optioneel item: zie "Optioneel klepje aan de achterzijde gebruiken" in de *Basishandleiding*.

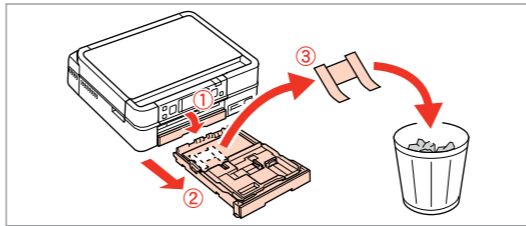
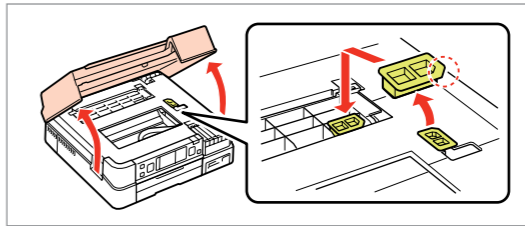
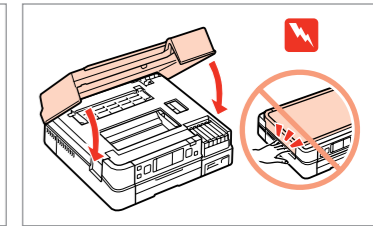
- 1**  Pull out, remove, and dispose.
Tirez, retirez et mettez au rebut.
Herausziehen, entfernen und entsorgen.
Uittrekken, verwijderen en weggooiden.
- 2**  Open, remove, and install.
Ouvrez, retirez et installez.
Öffnen, entfernen und installieren.
Openen, verwijderen en installeren.
- 3**  Close.
Fermez.
Schließen.
Sluiten.

Turning On
Mise sous tension
Einschalten
Aanzetten

2

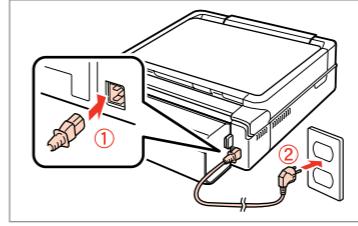
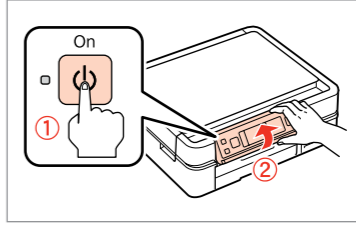
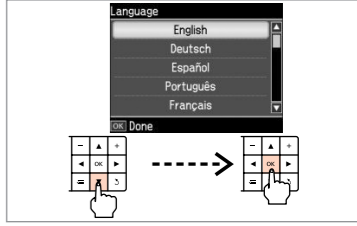
- 1**  Connect and plug in.
Connectez et branchez.
Anschließen und einstecken.
Aansluiten en stekker in stopcontact.
- 2**  Turn on and raise.
Mettez sous tension et soulevez.
Einschalten und hochklappen.
Aanzetten en omhoog klappen.
- 3**  Select a Language.
Sélectionnez une langue.
Sprache auswählen.
Taal selecteren.

Adjusting the Angle of the Panel
Réglage de l'angle du panneau
Einstellen des Bedienfeldwinkels
Hoek van paneel wijzigen

3

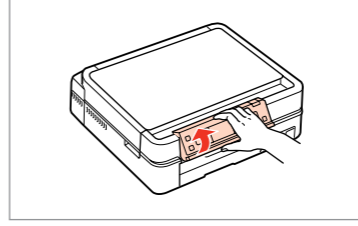
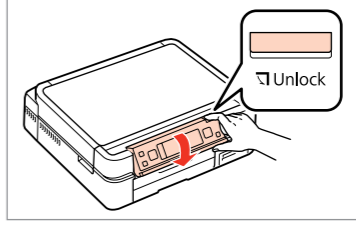
- 1**  Raise manually.
Soulevez manuellement.
Manuell hochklappen.
Met de hand omhoog zetten.
- 2**  Press **Unlock** to lower.
Appuyez sur **Unlock** pour abaisser.
Zum Absenken **Unlock** drücken.
Laten zakken met **Unlock**.

Attaching Panel Supplement Sticker
Fixation de l'autocollant supplémentaire du panneau
Bedienfeld-Zusatzaufkleber befestigen
Sticker op paneel aanbrengen

4

Depending on the location, the supplementary stickers may not be available.
Il est possible que les autocollants supplémentaires ne soient pas disponibles dans tous les pays.
Je nach Auslieferungsort sind möglicherweise keine Zusatzaufkleber verfügbar.
Stickers worden niet in alle landen bijgeleverd.

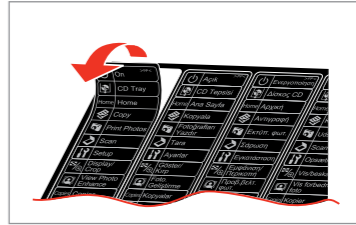
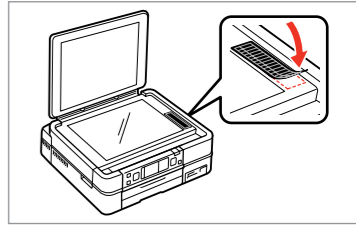
- 1**  Peel off.
Décollez.
Abziehen.
Losmaken.
- 2**  Stick.
Collez.
Aufkleben.
Vastplakken.

Installing the Ink Cartridges
Installation des cartouches d'encre
Installieren der Tintenpatronen
Cartridges installeren

5

For the initial setup, make sure you use the ink cartridges that came with this printer.
Lors de la configuration initiale, veuillez à utiliser les cartouches d'encre fournies avec l'imprimante.
Zur ersten Einrichtung ausschließlich die mit dem Drucker gelieferten Tintenpatronen verwenden.
Gebruik bij de eerste installatie de cartridges die bij deze printer zijn geleverd.

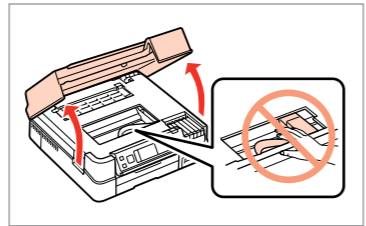
1  Open.
Ouvrez.
Öffnen.
Openen.

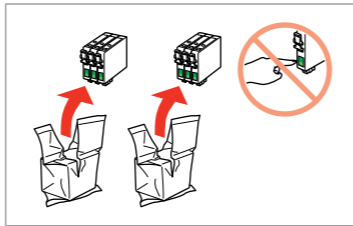
2  Unpack.
Déballez.
Auspacken.
Uitpakken.

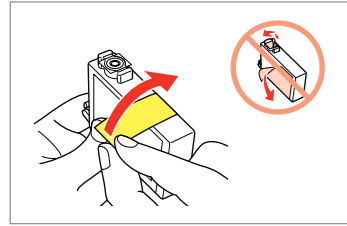
3  Remove yellow tape.
Retirez la bande adhésive jaune.
Gelbes Band entfernen.
Gele tape verwijderen.

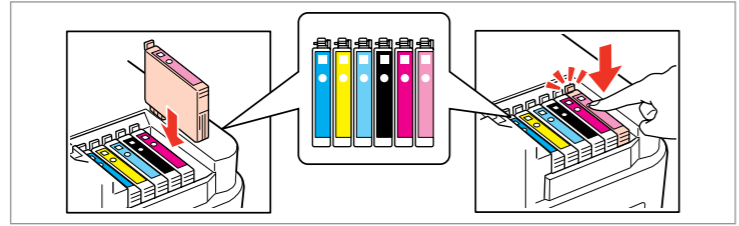
4  Install.
Installez.
Installieren.
Installeren.

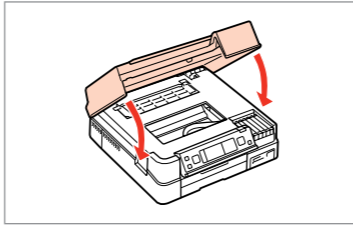
5  Press (click).
Appuyez (décliez).
Drücken (Klicken).
Aandrukken (klik).

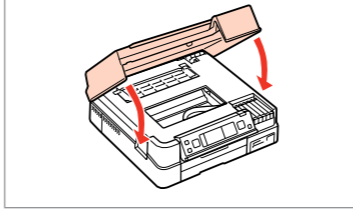
 Close.
Fermez.
Schließen.
Sluiten.

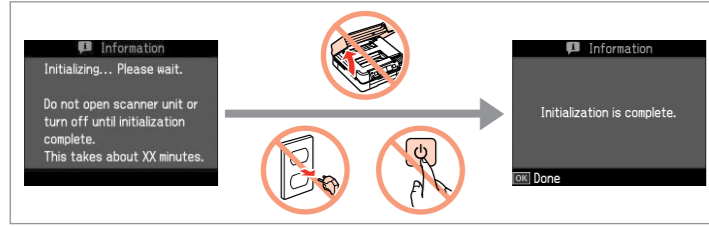
6  Wait.
Patiencez.
Warten.
Wachten.

The initial ink cartridges will be partly used to charge the print head. These cartridges may print fewer pages compared to subsequent ink cartridges.
Les cartouches d'encre initiales sont partiellement utilisées pour charger la tête d'impression. Ces cartouches peuvent imprimer moins de pages que les cartouches d'encre suivantes.
Die ersten Tintenpatronen werden teilweise für das Laden des Druckkopfes verwendet. Mit diesen Patronen können möglicherweise weniger Seiten gedruckt werden, als mit nachfolgenden Tintenpatronen.
De startcartridges worden deels verbruikt om de printkop te vullen. Met deze cartridges worden mogelijk minder pagina's afgedrukt dan met de cartridges daarna.

Selecting the Connection Type
Sélection du type de connexion
Wählen des Verbindungstyps
Type verbinding selecteren

6

For Wi-Fi and network connection, see the *Wi-Fi/Network Setup Guide*. For USB wired connection, go to the next section.
Pour les connexions Wi-Fi et réseau, reportez-vous au *Guide de configuration réseau/Wi-Fi*. Pour les connexions câblées USB, reportez-vous à la section suivante.
Wi-Fi- und Netzwerkverbindung, siehe *Wi-Fi/Netzwerkinstallationsanleitung*. USB-Kabelverbindung, siehe nächster Abschnitt.
Zie de *Installatiehandleiding Wi-Fi/netwerk* voor gebruik van een Wi-Fi- of netwerkverbinding. Zie het volgende gedeelte voor een vaste USB-verbinding.



USB Wired Connection
Connexion câblée USB
USB-Kabelverbindung
Verbinding met een USB-kabel

7

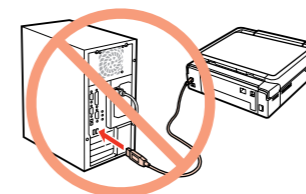

Do not connect the USB cable until you are instructed to do so.
Ne connectez pas le câble USB tant que vous n'y êtes pas invité.
Schließen Sie das USB-Kabel erst an, wenn Sie dazu aufgefordert werden.
Sluit de USB-kabel pas aan wanneer dit in de instructies wordt aangegeven.

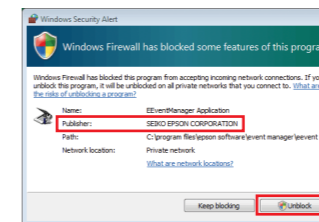

If the Firewall alert appears, allow access for Epson applications.
Si un avertissement relatif au pare-feu s'affiche, autorisez l'accès pour les applications Epson.
Wenn die Firewall-Warnung angezeigt wird, den Zugriff für Epson-Anwendungen erlauben.
Verleen Epson-toepassingen toegang als een firewallwaarschuwing wordt weergegeven.

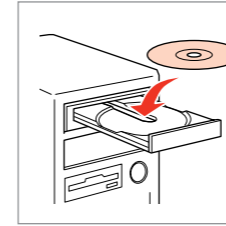
1  Insert.
Insérez.
Einlegen.
Plaatsen.

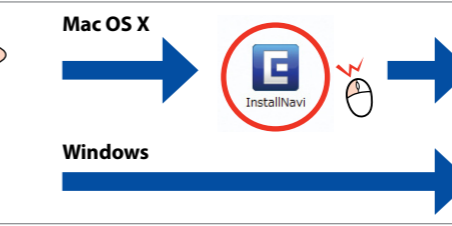
2  Click.
Cliquez.
Klikken.

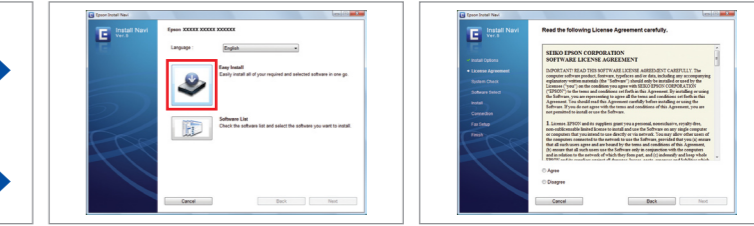
3  Follow the instructions.
Suivez les instructions.
Folgen Sie den Anweisungen.
Instructies volgen.

Mac OS X
Windows

Windows: No installation screen? →
Windows : aucun écran d'installation n'apparaît ? →
Windows: Kein Installationsbildschirm? →
Windows: geen installatievenster? →

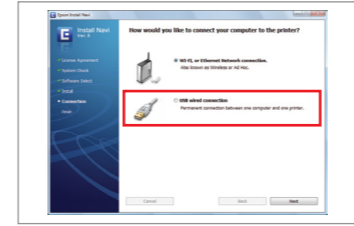
4  Select and follow the instructions.
Sélectionnez et suivez les instructions.
Auswählen und den Anweisungen folgen.
Selecteren en instructies volgen.

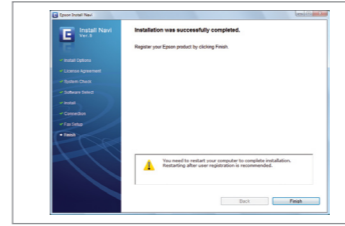
5  Installation complete.
Installation terminée.
Die Installation ist abgeschlossen.
Installatie voltooid.

Getting More Information
Informations complémentaires
Weitere Informationsquellen
Meer informatie



Basic Operation Guide
Guide des opérations de base
Benutzerhandbuch - Grundlagen
Basishandleiding

User's Guide/Network Guide
Guide d'utilisation/Guide réseau
Benutzerhandbuch/Netzwerkhdbuch
Gebruikershandleiding/Netwerkhdbuch

IT Inizia qui
ES Para empezar
PT Começar por aqui

 Osservare attentamente le avvertenze per evitare danni alla persona.
Siga atentamente las advertencias para evitar lesiones.
Tem de seguir este símbolo com cuidado para evitar ferimentos.

Maschinenlärmformations-Verordnung 3. GPSGV: Der höchste Schalldruckpegel beträgt 70 dB(A) oder weniger gemäß EN ISO 7779.

Das Gerät ist nicht für die Benutzung im unmittelbaren Gesichtsfeld am Bildschirmarbeitsplatz vorgesehen. Um störende Reflexionen am Bildschirmarbeitsplatz zu vermeiden, darf dieses Produkt nicht im unmittelbaren Gesichtsfeld platziert werden.

EEE Yönetmeliğine Uygundur.

Информация об изготовителе
Seiko Epson Corporation (Япония)
Юридический адрес: 4-1, Ниси-Синзюку, 2-Чоме, Синзюку-ку, Токио, Япония
Срок службы: 3 года

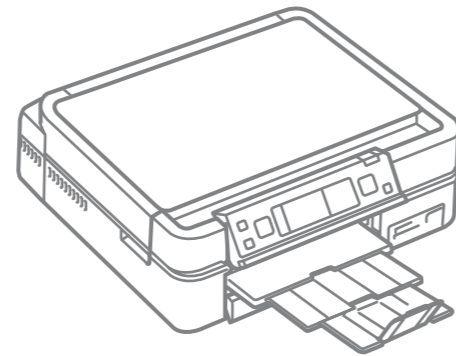

Disimballaggio
Desembalaje
Desembalagem

1

Il contenuto può variare a seconda dell'area.
El contenido varía según la región.
O conteúdo varia em função do país.

Non aprire la confezione della cartuccia di inchiostro fino a quando non si è pronti per la sua installazione nella stampante. La cartuccia viene fornita in confezione sottovuoto per preservarne l'affidabilità.
No desembale el cartucho de tinta hasta que vaya a instalarlo en la impresora. Está envasado al vacío para conservar todas sus propiedades.
Abra apenas a embalagem do tinteiro quando estiver pronto para o instalar na impressora. O tinteiro é embalado em vácuo para manter a sua fiabilidade.

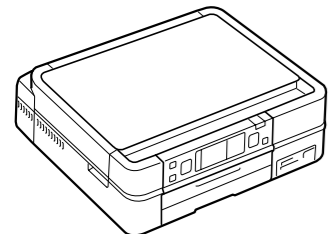

Rimuovere tutti i materiali protettivi.
Retire los materiales de protección.
Retire todos os materiais de protecção.

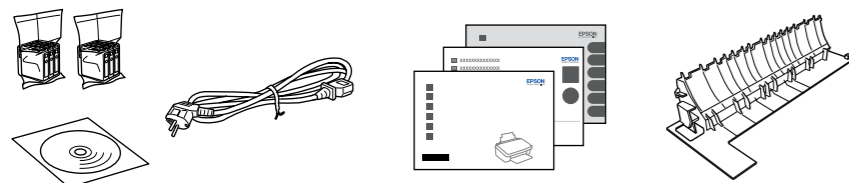

Elemento opzionale: vedere "Uso del coperchio posteriore opzionale" nella *Guida d'uso generale*.
Accesorio opcional: véase "Uso de la cubierta posterior opcional" en el *Manual de funcionamiento básico*.
Item opcional: consulte "Utilizar a tampa posterior opcional" no *Guia de Operações Básicas*.

1

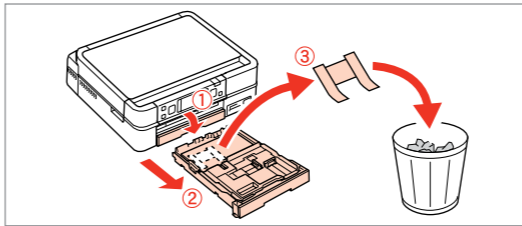

Estrarre, rimuovere e smaltire.
Tire, saque y deseche.
Puxe para fora, retire e deite fora.

2

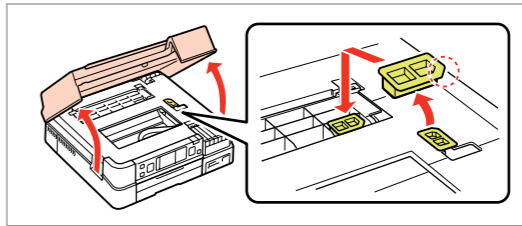

Aprire, rimuovere e installare.
Abra, saque e instale.
Abra, retire e instale.

3

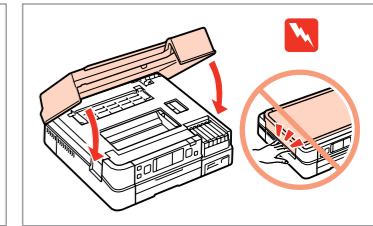

Chiudere.
Cierre.
Feche.

Accensione
Encendido
Ligação

2

1

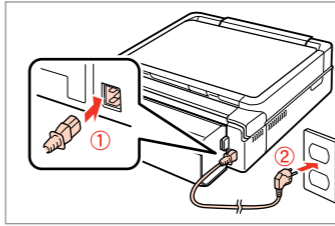

Connettere e collegare alla presa.
Conecte y enchufe.
Ligue à impressora e à corrente.

2

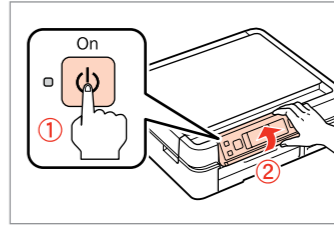

Accendere e sollevare.
Encienda y levante.
Ligue e levante.

3

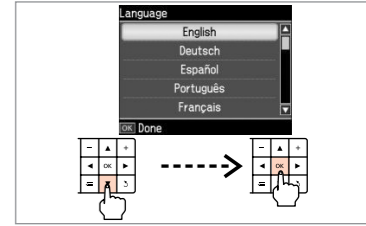

Selezionare una lingua.
Elija un idioma.
Selecione um idioma.

Regolazione dell'angolo del pannello
Ajuste del ángulo del panel
Ajustar o Ângulo do Painel

3

1

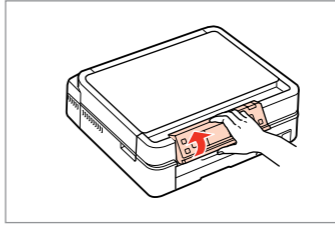

Sollevare manualmente.
Súbalo con la mano.
Levante manualmente.

2

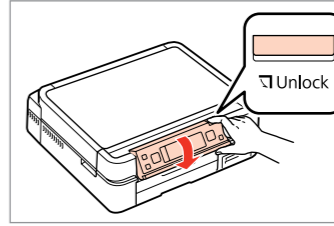

Premere **Unlock** per abbassare.
Pulse **Unlock** para bajarlo.
Pressione **Unlock** para baixar.

Posizionamento dell'adesivo supplementare per pannello
Colocación del adhesivo del panel
Colocar o Autocolante do Painel

4

A seconda dell'area di residenza, gli adesivi supplementari potrebbero non risultare disponibili.
En algunas regiones no están disponibles los adhesivos para el panel.
Consoante o país, os autocolantes suplementares podem não estar disponíveis.

1

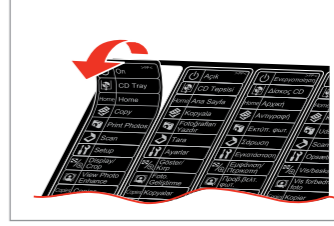

Staccare.
Despéguelo.
Descole.

2

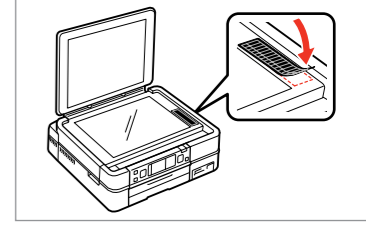

Posizionare.
Péguelo.
Cole.

Installazione delle cartucce d'inchiostro
 Instalación de los cartuchos de tinta
 Instalar os Tinteiros

5

Per l'installazione iniziale, assicurarsi di usare le cartucce fornite con la stampante.
 Para la instalación inicial, use siempre los cartuchos de tinta que acompañan a esta impresora.
 Na configuração inicial, certifique-se de que utiliza os tinteiros fornecidos com esta impressora.

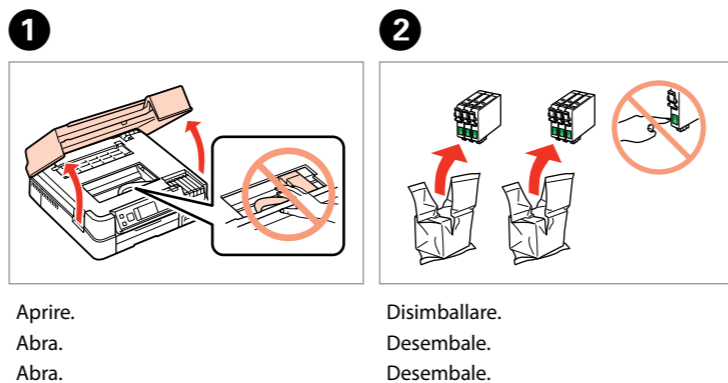

1
 Aprire.
 Abra.
 Abra.

2
 Disimballare.
 Desembale.
 Desembale.

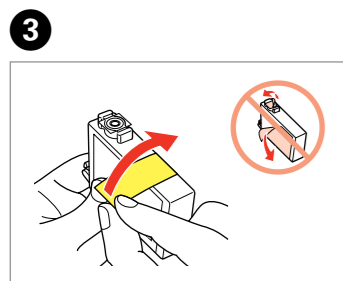

3
 Rimuovere il nastro giallo.
 Retire el precinto amarillo.
 Retire a fita amarela.

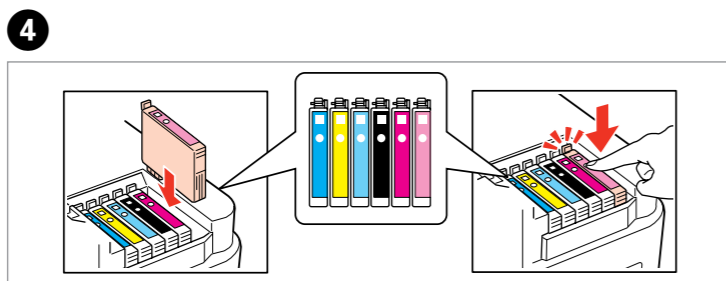

4
 Installare.
 Instale.
 Instale.

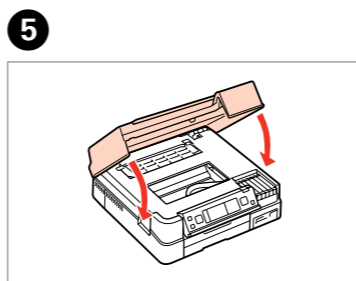

5
 Chiudere.
 Cierre.
 Feche.

Premere (clic).
 Pulse (clic).
 Pressione (clique).

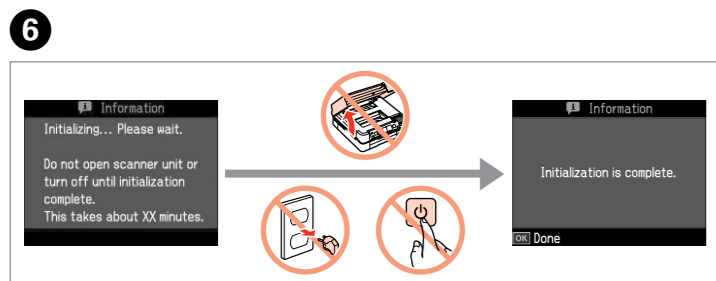

6
 Attendere.
 Espere.
 Aguarde.

Le cartucce di inchiostro iniziali verranno parzialmente utilizzate per caricare la testina di stampa. Tali cartucce potrebbero stampare meno pagine rispetto alle successive cartucce di inchiostro.
 Los primeros cartuchos de tinta se usarán parcialmente para cargar el cabezal de impresión. Por eso imprimirán menos páginas que los próximos que instale.
 Os tinteiros instalados inicialmente serão utilizados em parte para carregar a cabeça de impressão. Estes tinteiros poderão imprimir menos páginas do que os tinteiros posteriores.

Selezione del tipo di connessione
 Selección del tipo de conexión
 Seleccionar o Tipo de Ligação

Per la connessione di rete o Wi-Fi, vedere la Guida di impostazione di rete/Wi-Fi. Per la connessione cablata USB, andare alla sezione successiva.
 Para una conexión Wi-Fi o de red, consulte el Manual de configuración de la red/Wi-Fi. Si es una conexión USB cableada, vaya a la siguiente sección.
 Para uma ligação de rede e Wi-Fi, consulte o Guia de Configuração de Rede/Wi-Fi. Para uma ligação com fios USB, avance para a secção seguinte.



6

Connessione cablata USB
 Conexión USB cableada
 Ligação com fios USB

7

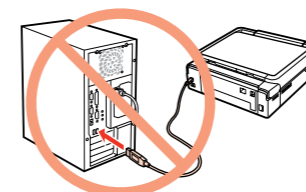

Non collegare il cavo USB fino a quando non espressamente richiesto.
 No conecte el cable USB hasta que se le indique.
 Ligue apenas o cabo USB quando isso lhe for solicitado.

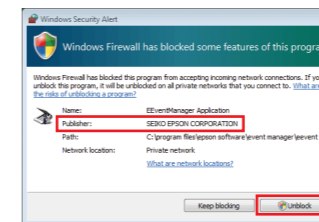

Se appare l'avviso firewall, consentire l'accesso alle applicazioni Epson.
 Si aparece el aviso de Firewall, permita el acceso a las aplicaciones de Epson.
 Se aparecer o alerta de firewall, permita o acesso às aplicações Epson.

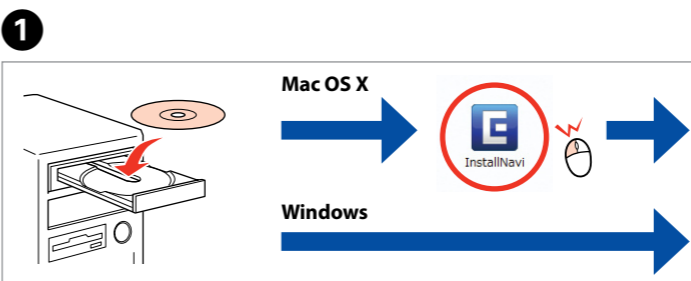

1
 Inserire.
 Inserte.
 Insira.

Mac OS X
 Windows
 Windows: Nessuna schermata d'installazione? →
 Windows: ¿No aparece la pantalla de instalación? →
 Windows: Nenhum ecrã de instalação? →

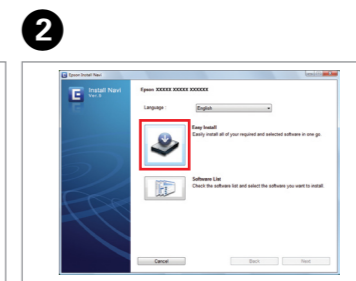

2
 Fare clic.
 Haga clic.
 Clique.

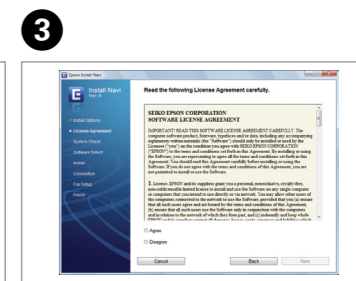

3
 Seguire le istruzioni.
 Siga las instrucciones.
 Siga as instruções.

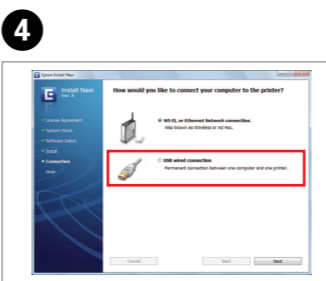

4
 Selezionare e seguire le istruzioni.
 Seleccione y siga las instrucciones.
 Selecione e siga as instruções.



5
 Installazione completata.
 Instalación terminada.
 Instalação concluída.

Come ottenere ulteriori informazioni
 Cómo obtener más información
 Obter Mais Informações



Guida d'uso generale
 Manual de funcionamiento básico
 Guia de Operações Básicas

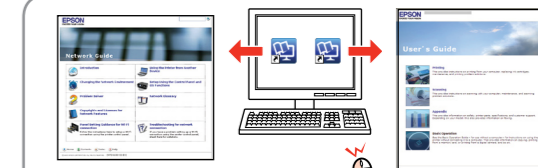

Guida utente/Guida di rete
 Manual de usuario/Manual de red
 Guia do Utilizador/Guia de Rede