

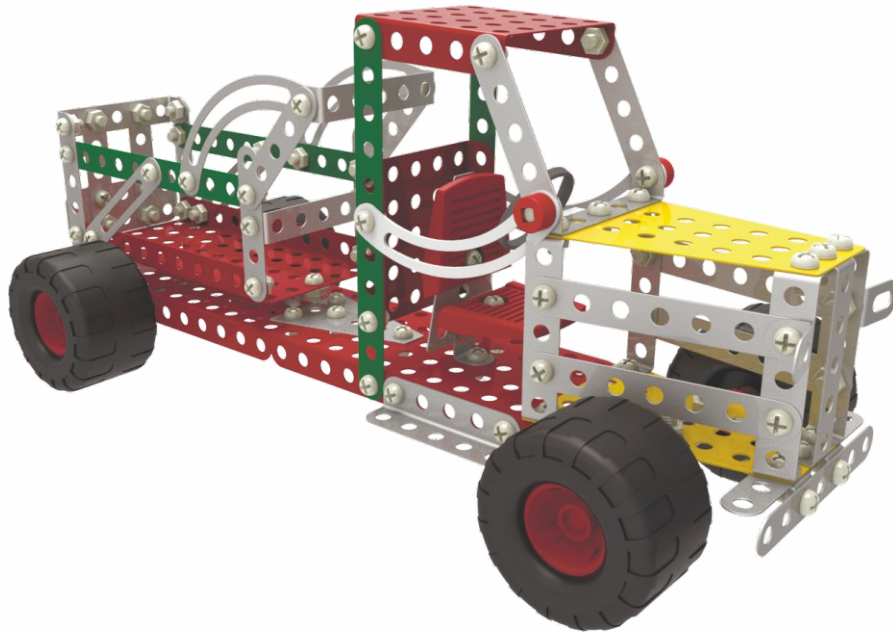





















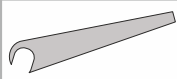
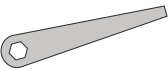

# МЕТАЛЕВИЙ КОНСТРУКТОР



ВАНТАЖІВКА

236  
деталей

## Комплектація / Комплектація

 001-8шт. планка 5	 003-8шт. планка 7	 004-10шт. скоба	 005-4шт. планка 11	 006-1шт. пластина 10	 007-2шт. кутник (уголок) 10	 021-2шт. плита 35
 023-3шт. плита 77	 025-7шт. кутник (уголок)	 030-2шт. планка 3	 031-4шт. планка дуга	 032-2шт. пластина 7	 033-2шт. пластина 23	 035-1шт. ключ 1
 036-1шт. ключ 2	 037-1шт. кутник (уголок) 120°	 101-1шт. викрутка (отвертка)	 103-2шт. вісь (ось) 85	 106-80шт. гвинт (винт) M4x6	 107-80шт. гайка M4	 201-4шт. колесо велике (большое)
 206-1шт. кермо (руль)	 212-2шт. спинка	 214-4шт. ролик	 216-4шт. шайба 6			

Для з'єднання деталей використовувати гвинт та гайку  
Для крепления деталей использовать винт и гайку



ВІДЕОІНСТРУКЦІЯ

YouTube  
TechnoK Toys



[www.technoktoys.com](http://www.technoktoys.com)

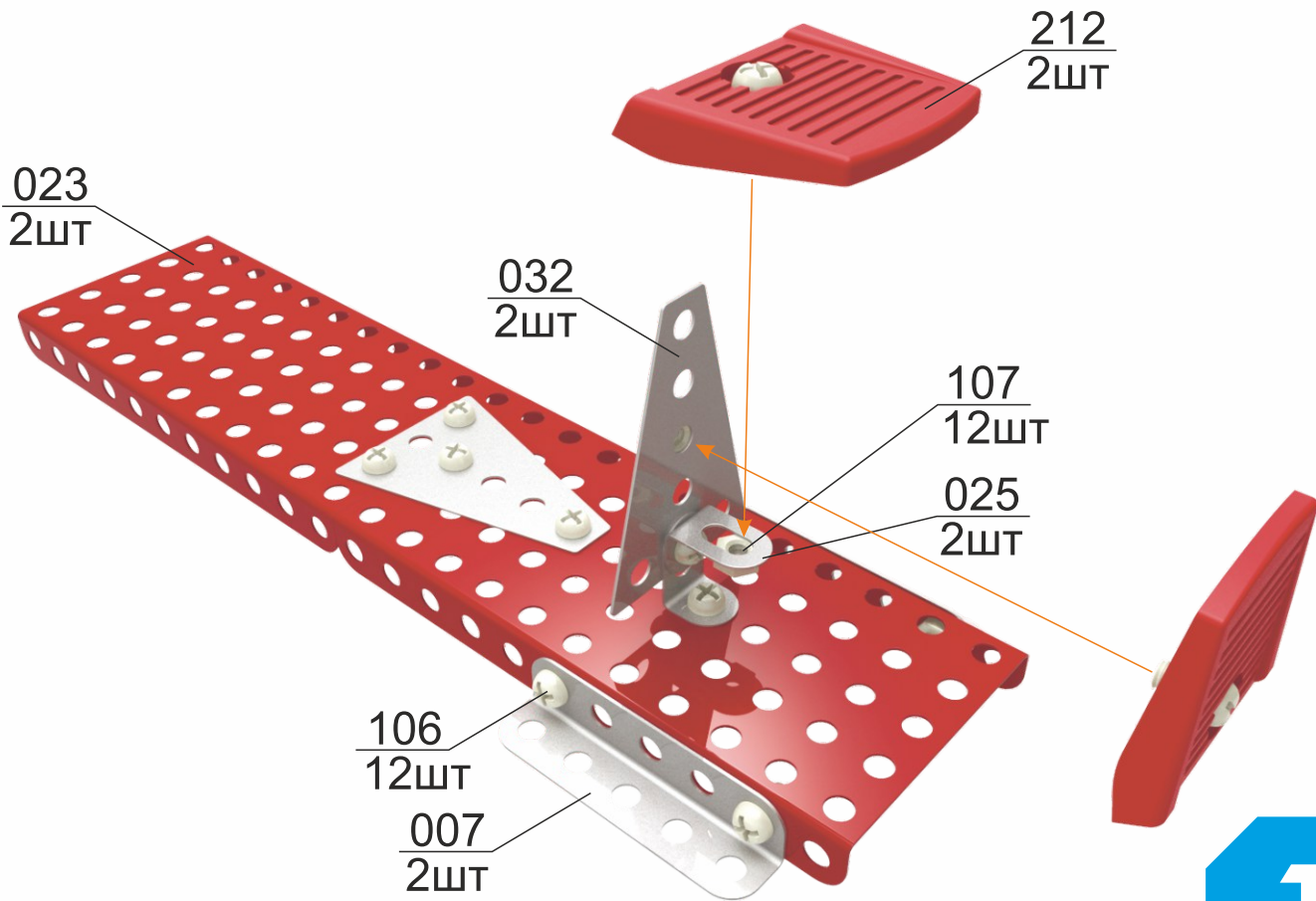

1

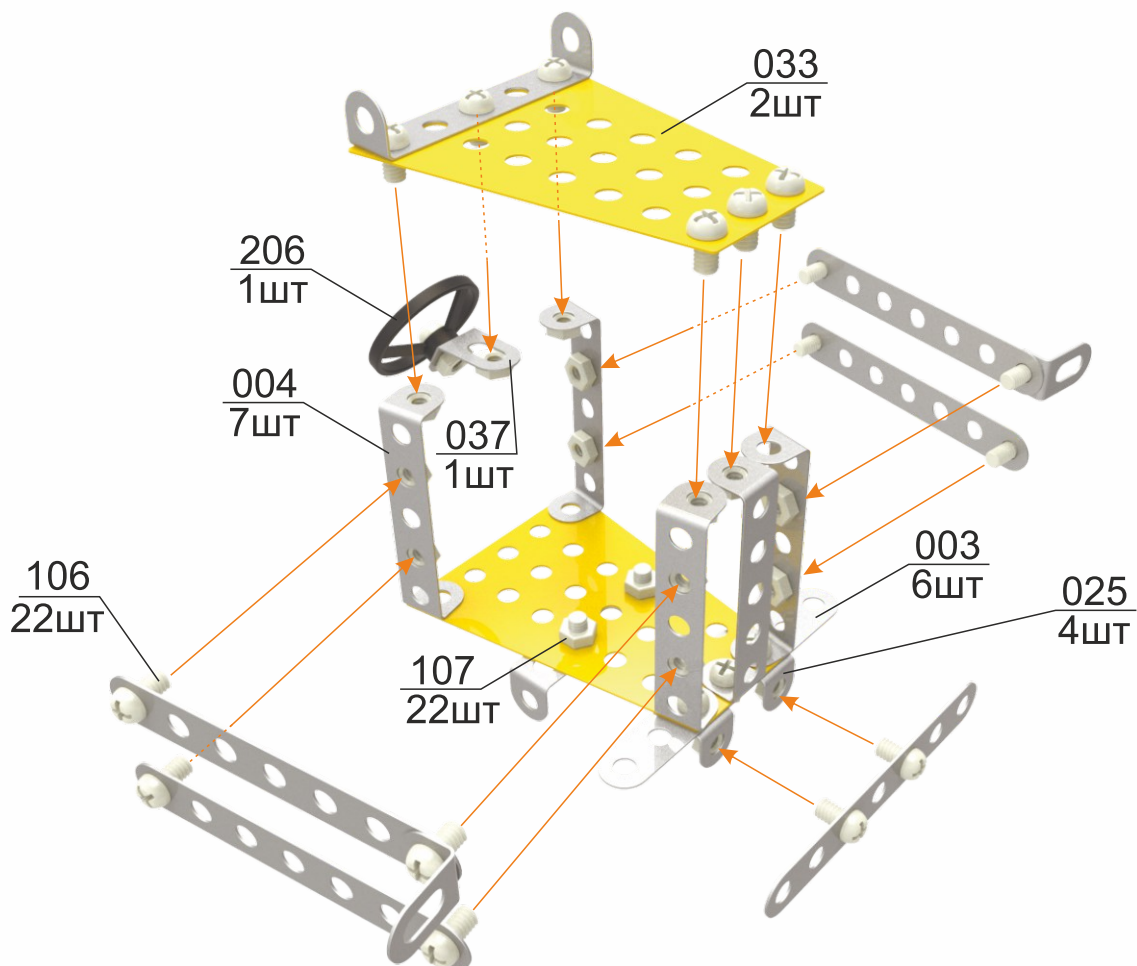

2

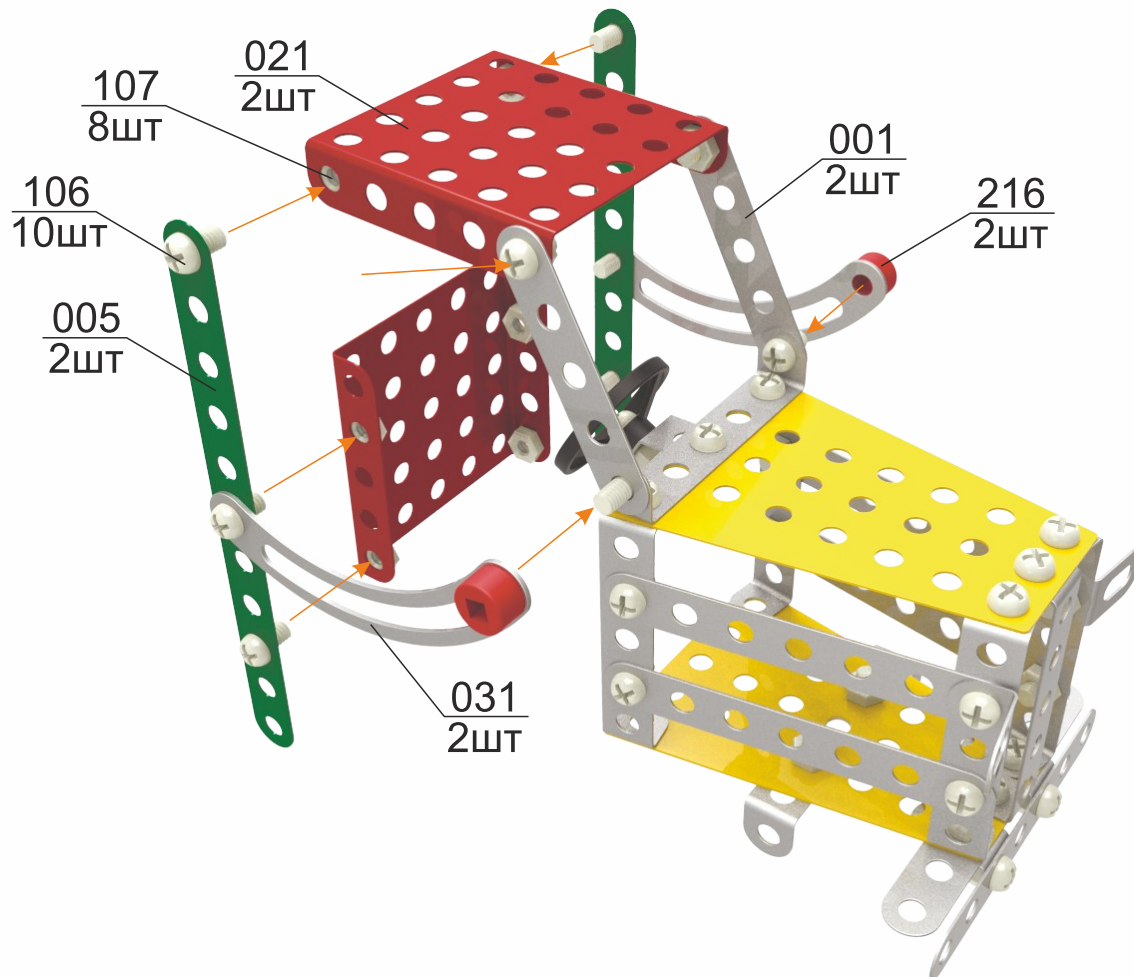

3

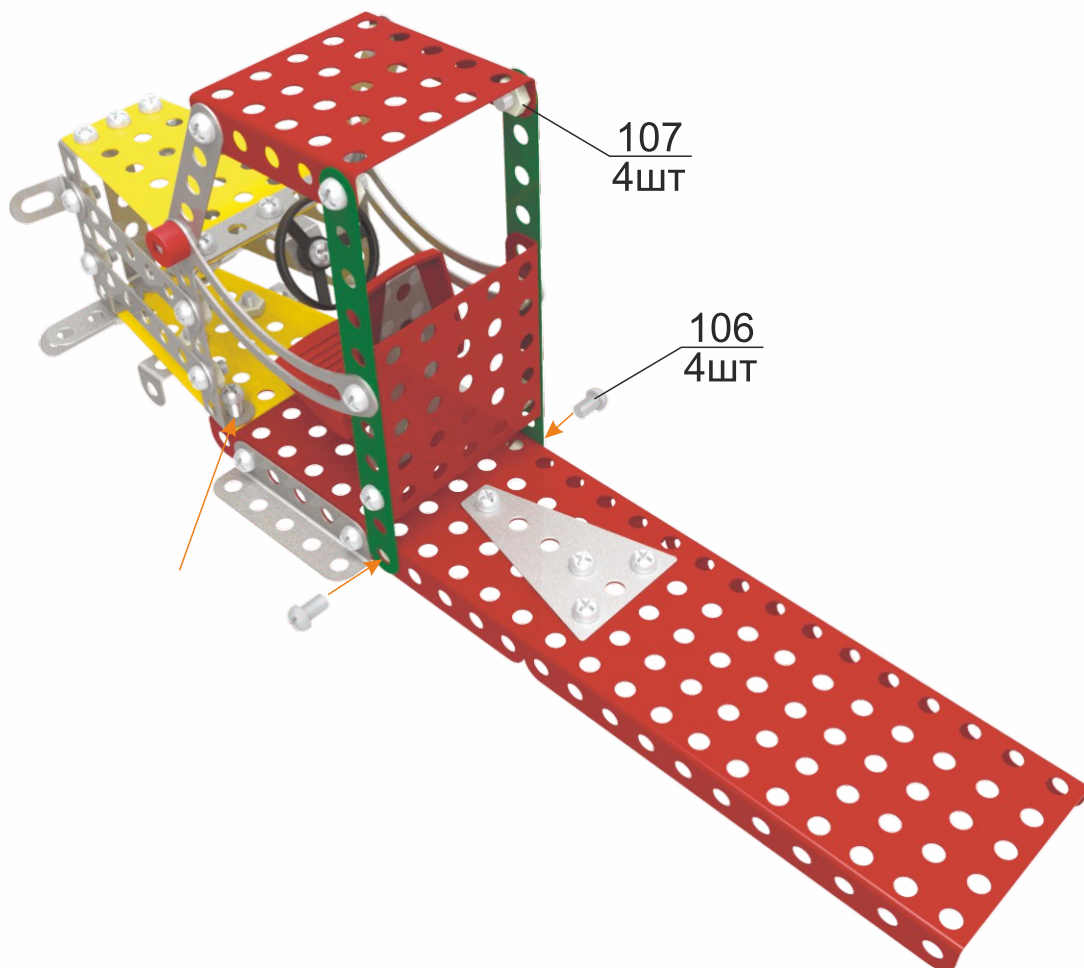

4

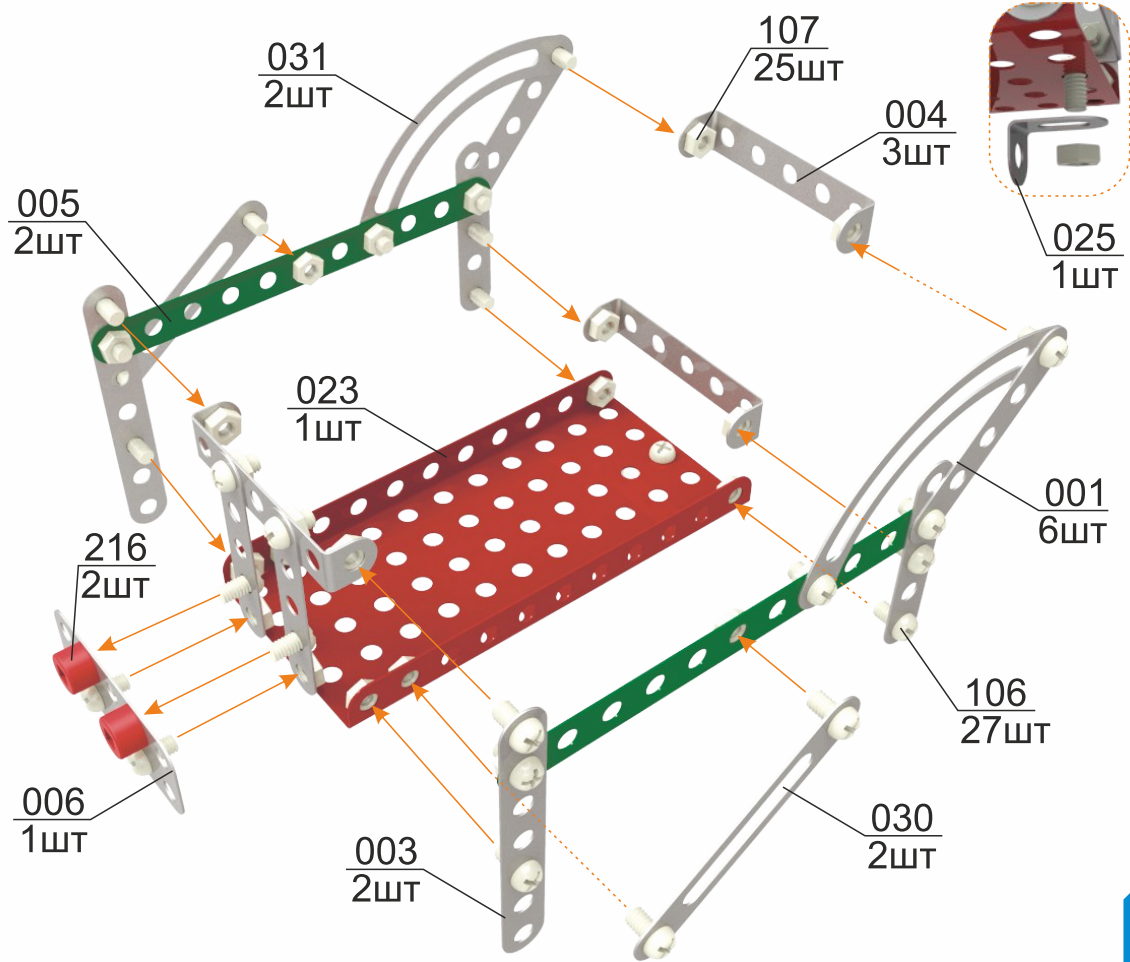

5

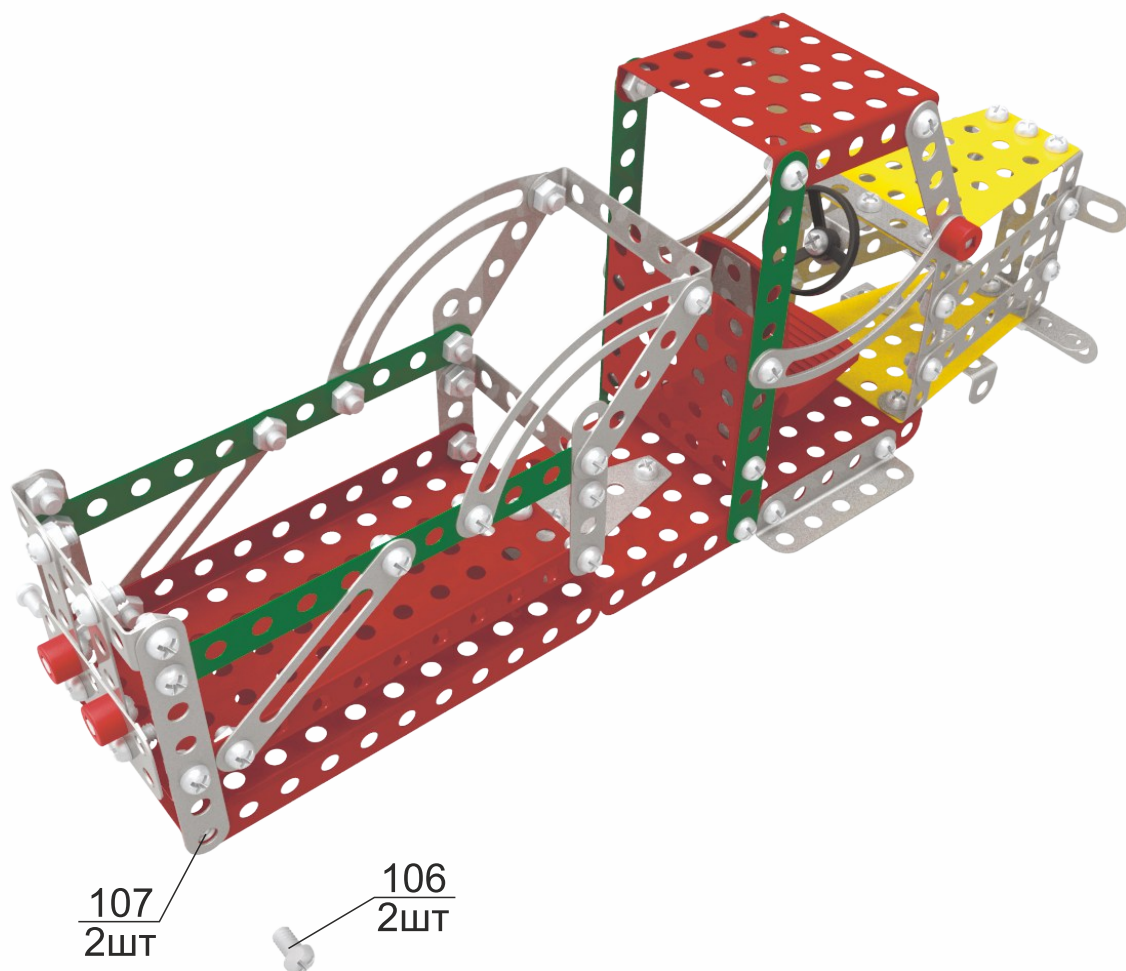

6

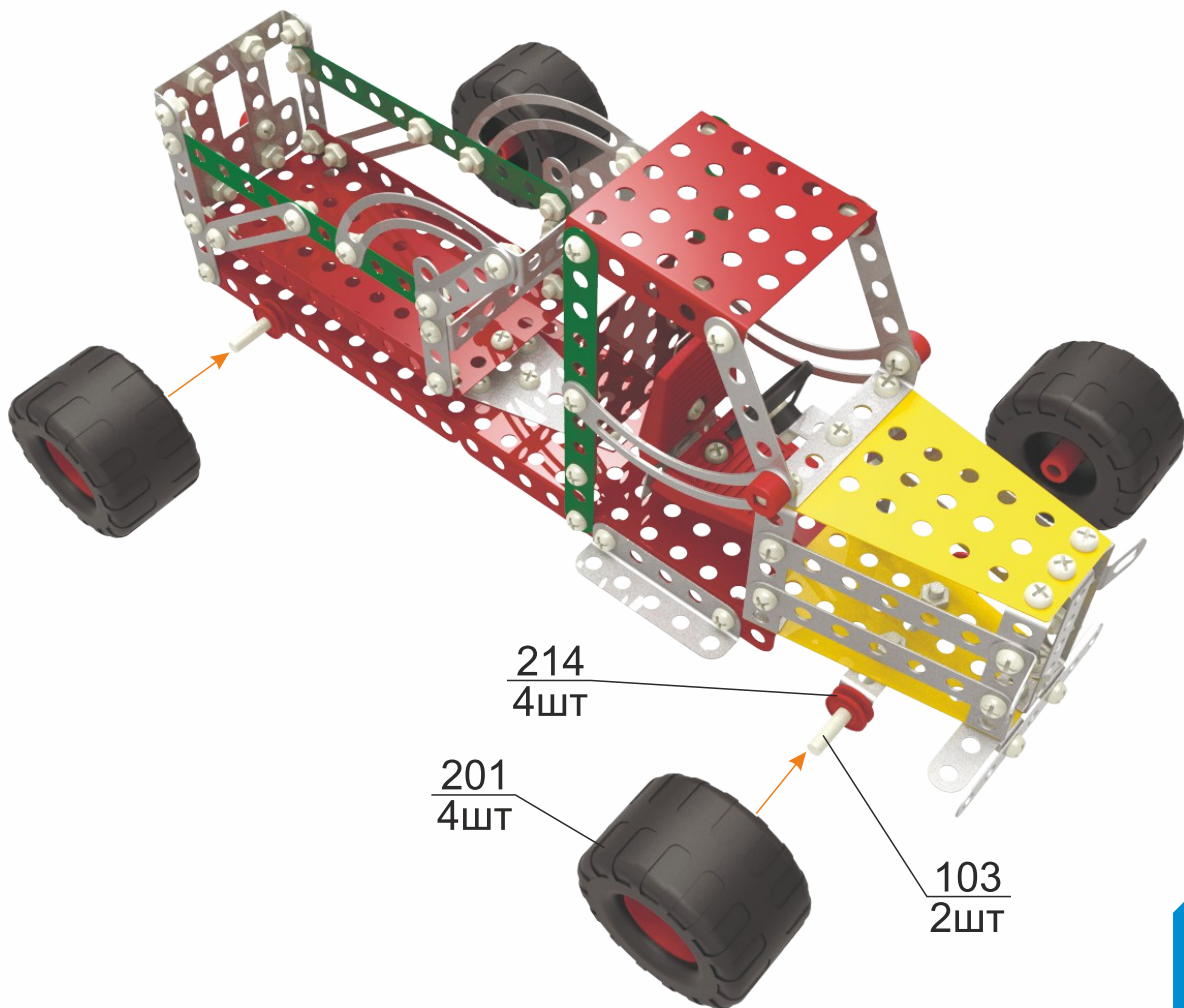

7

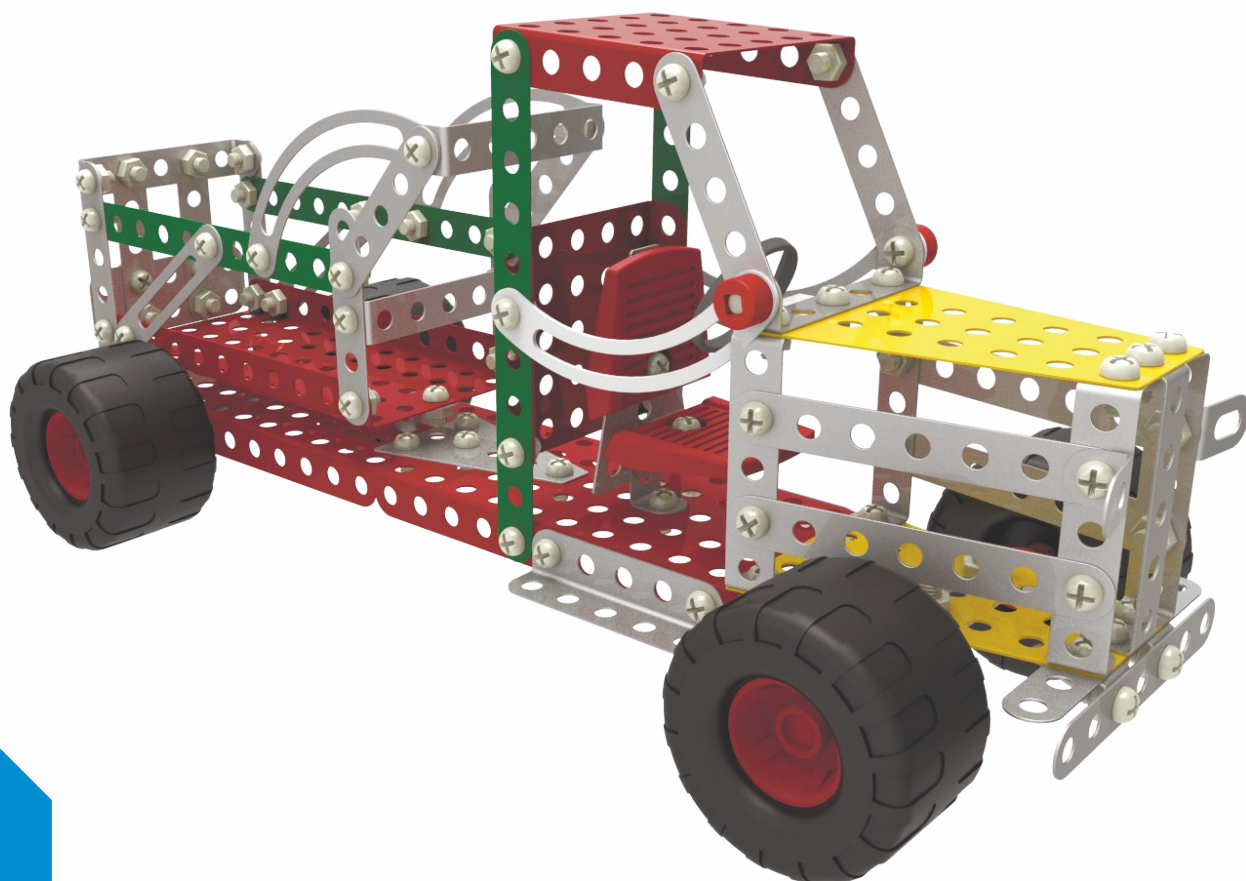

8



# МЕТАЛЕВИЙ КОНСТРУКТОР

Collect them all

ВІДЕОІНСТРУКЦІЯ



[www.technoktoys.com](http://www.technoktoys.com)

